

ZIP HydroTap® G4 Celsius User Guide

- Tap Operation.....(Pages 3-5)
- LCD Screen & Menu(Pages 6-19)
- Maintenance..... (Pages 20-23)
- Contact & Details..... (Page 24)
- Date of Installation...../...../.....



**Affix Model Number Label
Here
802698**



NOTES



Tap operation - Chilled Sparkling

Turning the rotary control allows the dispensing of either Chilled Sparkling or Chilled water. For your convenience, the rotary control is spring loaded, so when released, will return automatically to the OFF position

To dispense Sparkling water: (Model CSHA)

Turn the rotary control forward as shown



Tap operation - Chilled water

To dispense Chilled water: (Model CHA)

Turn the rotary control in reverse as shown



Tap operation - Boiling water

To dispense Boiling water: with the safety ON.

Tapping the illuminated RED safety button twice, with one finger, will cause the safety red light to flash for a few seconds. While flashing, turn the rotary control (as shown) to dispense boiling water. (See section G for safety settings)

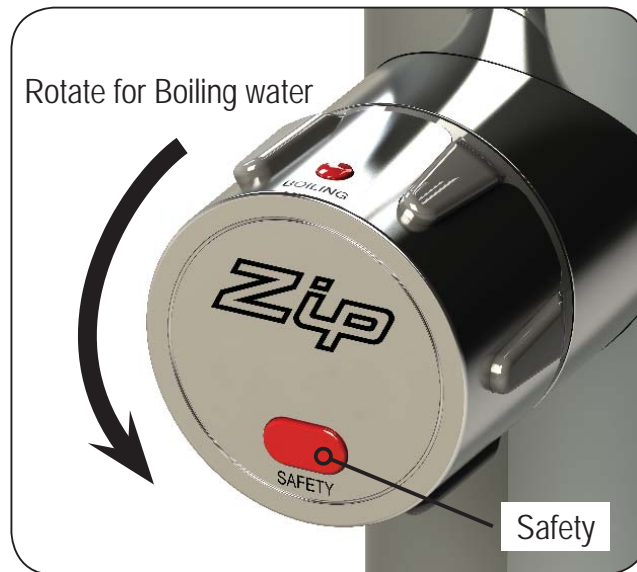

To dispense Boiling water: with the safety OFF.

When the RED safety light is OFF, turn the rotary control (as shown) to dispense boiling water.

Tap operation - Mixer

The Mixer tap lever is operated as a conventional 'Flick Mixer'. The hot side is marked with a red stripe and the cold side with a blue stripe, for dispensing cold to warm water.

Lifting the handle up will decrease the flow rate and lowering the handle will increase the flow rate. Lift the handle all the way up to turn the tap off.

When the handle is moved towards the blue mark, the temperature is decreased and when moved towards the red mark, the temperature is increased. The final temperature will be dependant on the temperature of the incoming cold water.

The spout may be swivelled, left or right, through 170° for convenience.

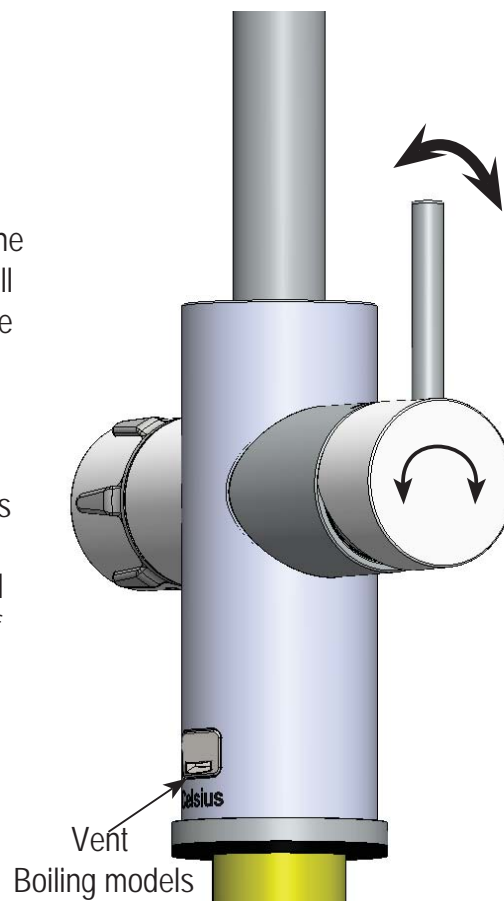

Filter Warning and Reset

Temperature Warning Light:

The warning light will flash slowly for 1 sec On and 3 secs OFF whenever the water is not at the temperature set point. The tap may be operated, but the water may not be at the desired temperature. The slow flashing light will turn off once the water reaches the set point. The set point temperature is user adjustable (See section G).

Filter Warning Light:

As a reminder that the filter requires changing, the warning light will flash quickly every 10 secs. (See section on filter maintenance.)

Filter Reset:

The warning light will need to be reset after the filter has been changed. (See section C)

Fault Warning Lights:

If there is a fault with the system, both the safety light and the warning light will flash for 1/2 sec ON and 1/2 sec OFF until the fault is rectified. (See section B) or call an authorised service man.



Sleep mode (Boiling models)

In SLEEP MODE the unit will Go to "Sleep" after 2 hrs of inactivity, after which, the home screen status window will show "Sleep Mode".

The sleep mode may be activated from the settings menu. (See section G).

To wake from sleep mode, first tap the safety twice and then turn the rotary control.

LCD Screen

The Zip HydroTap G4 Celsius introduces a 'TOUCH' screen for easy setup and operation adjustment.

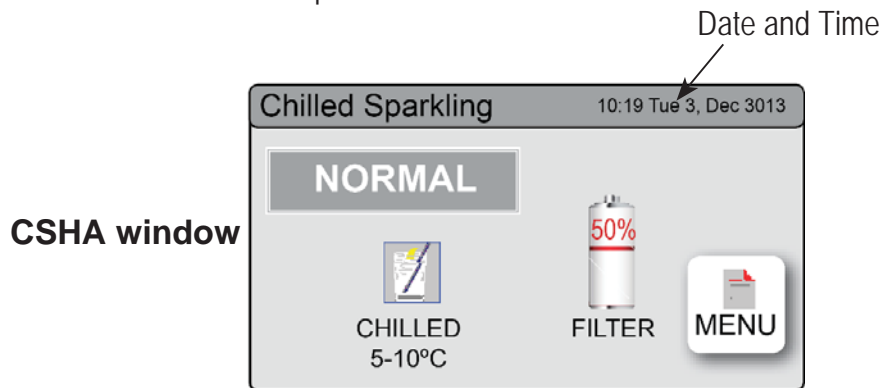
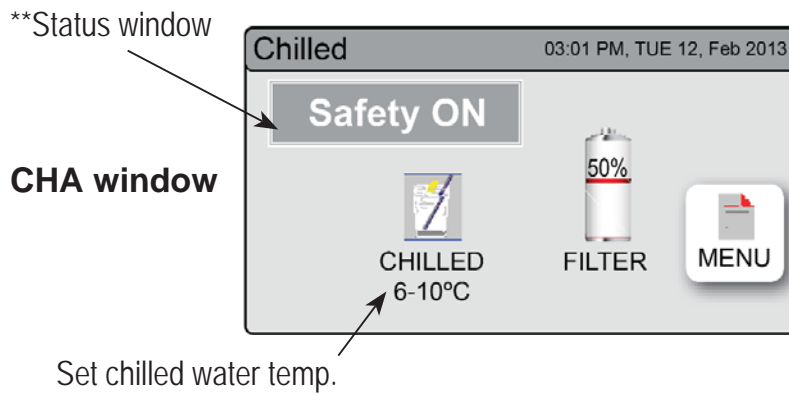
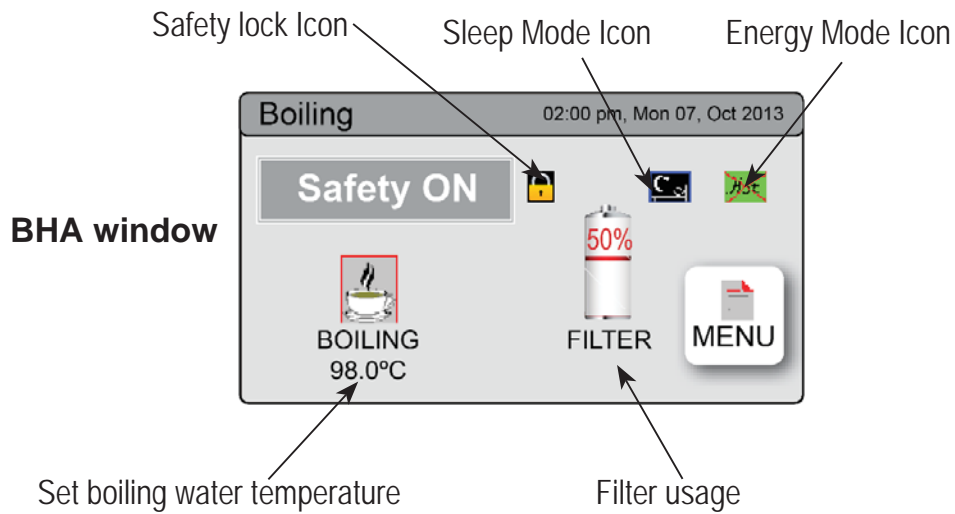

Other possible messages in status window:

Status**	Information	Notes
System Fault	Product has one or more system faults	Refer to section B faults
Change Filter	External/Internal filter needs to be replaced	Refer to section C

NOTE: As an energy saving feature, the home screen will turn OFF After 5 minutes of non use. Touching the darkened LCD panel will reactivate the home screen.

LCD Screen Menu

Main Menu	Sub Menu	Sub Menu Options	Section
Language	<ul style="list-style-type: none"> English German 		A
Information	<ul style="list-style-type: none"> Product Info System Faults Event Log 	<ul style="list-style-type: none"> Product serial no. Lists 	B
Installation	<ul style="list-style-type: none"> Filter Flush Filter Reset 	<ul style="list-style-type: none"> Reset options Calibration options 	C
Service	Password protected		D
Security	<ul style="list-style-type: none"> Enable Password 	<ul style="list-style-type: none"> Set Password Change Password 	E
Communication	<ul style="list-style-type: none"> Remote Monitor Remote Control 	<ul style="list-style-type: none"> Wifi Options Wifi Options 	F
Settings	<ul style="list-style-type: none"> Date/Time Temperature Filter Energy Modes Safety Dispense Times 	<ul style="list-style-type: none"> 12hr/24hr Mode Hot/Cold Setpoint Filter Life (Litres) Filter Life (Months) Sleep Mode Options Safety Lock Hot/Cold Dispensing 	G

LCD Screen operation - Section A

A Set Language

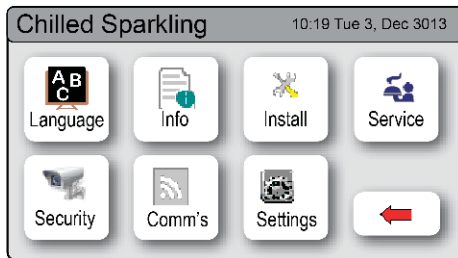

1. Press [MENU] for main menu.
2. Press [Language] button.
3. Select the preferred language
4. Press [<=] button for the previous menu

LCD Screen operation - Section B

B System Information

In this section, you can find your product serial number , check system fault messages or view the event logs of your product.

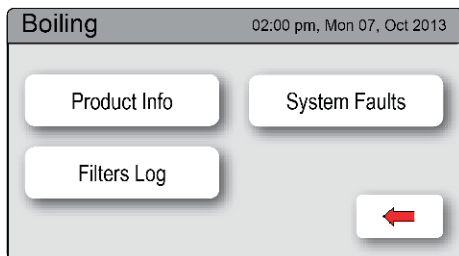

1. Press the [MENU] button for main menu.
2. Press the [Info] button to view the product serial number and other key information

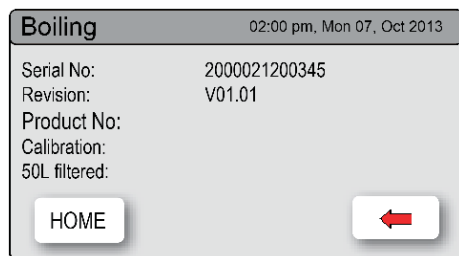

1. Press [Product Info] to view the product serial no.
2. Press [<=] button for the previous menu or press [Home] button to return to the home screen.

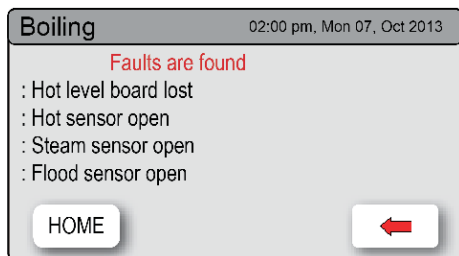

1. Press [System Faults] to check the fault information;
2. Press [<=] button for the previous menu or press [Home] button to return to the home screen.

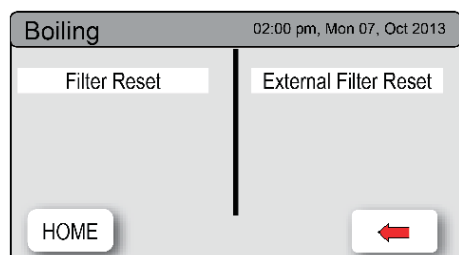

Press [Filter Log] to view the system's filter log.

1. Press [<=] button for the previous menu or press [Home] button to return to the home screen.

LCD Screen operation - Section C

C Install

Once your Zip HydroTap G4 unit has been installed, Go to Install menu to configure the system settings for your product.

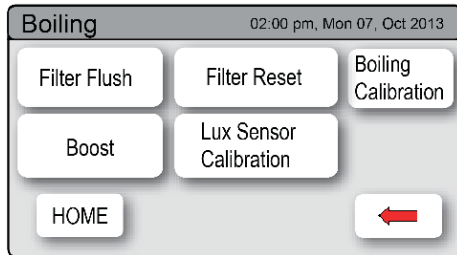

Sub menu:

1. Filter Flush
2. Filter Reset
3. Boiling Calibration
4. Booster
5. Lux Sensor Calibration

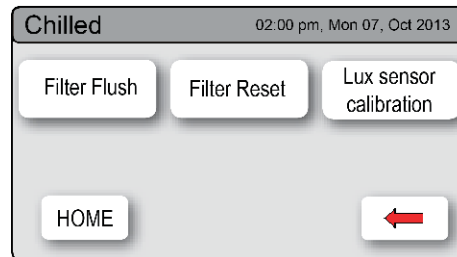

CHA Screen

Follow 1,2 & 5.above

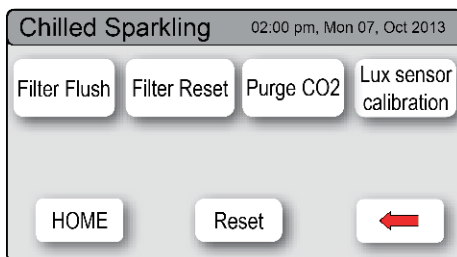

CSHA Screen

Follow 1,2 & 5.above

Follow CO₂ purge below

CO₂ Purge (CSHA Model)

When fitting a new gas bottle, it is important to purge the gas lines.

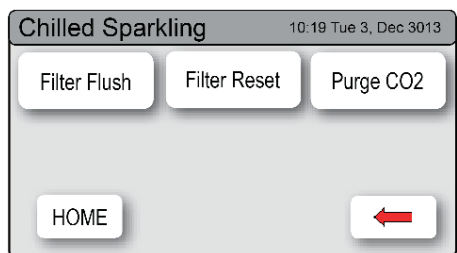

1. Press the [MENU] button for main menu.
2. Press the [Install] button.
3. Press the [Purge CO₂] button.
4. In the next screen, press the [START] button to commence the purging process.
5. Wait for the water to stop flowing through the unit.
6. Wait a further 10 seconds after the water has stopped flowing. During this time you will hear the CO₂ gas escaping through the tap.
7. Press [STOP] to end the purge.
8. Press [=] button for the previous menu or press the [Home] button to return to the home screen.

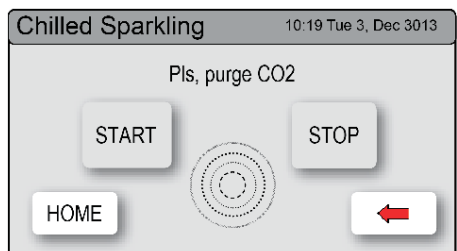

1 - Filter Flush (All)

Have a 10L bucket or similar container (not supplied) at the ready to hold a quantity of water that will be ejected while the Filter Flush Mode is in operation. Open the filter access door on the front of the HydroTap and the filter cartridge will be exposed. Located to the rear RHS of the cartridge is a flush line, approx 600mm long and the flush line stop cock. Place the valve end of the flush line into the 10L bucket or container (not supplied).

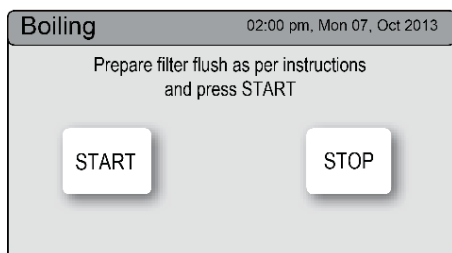

NOTE: Run at least 10 Ltrs of water through to flush the filter of any excess black carbon particles (this is normal). Once the filter flush has finished, press the Stop button to display the main menu

1. Press the [MENU] button for main menu.
2. Press the [Install] button. Turn the stop cock ON.
3. Press the [Filter Flush] button.
4. Press [Start] button to start filter flush. Once the filter flush is finished, Turn the stop cock OFF first (to ensure the cock is properly closed) then press [Stop] to end filter flush mode.
5. Press [<=] button for the previous menu or press [Home] button to return to the home screen.
6. After initial installation, Turning OFF the Filter Flush Mode puts the HydroTap into calibration mode. With subsequent filter changes, the system reverts to the main menu.

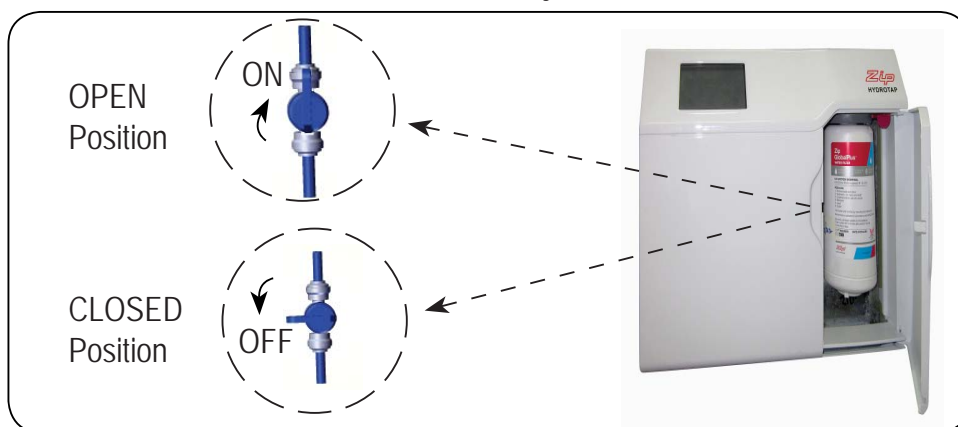

The Zip HydroTap allows the user to adjust the filter life and to edit the filter usage. (See filter details on Pages 14 -15).

LCD Screen operation - Section C

2 - Filter Reset (All)

After replacing the filter, the counters should be reset

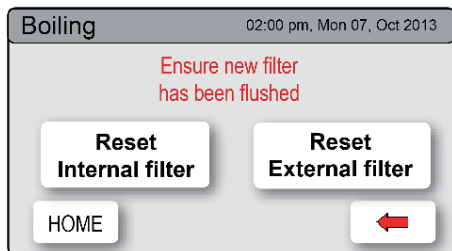

1. Press the [MENU] button for main menu.
2. Press the [Install] button.
3. Press the [Filter Reset] button.
4. To set the filter life or edit filter usage, refer to section G- Filter.

3 - Boiling Calibration (Boiling models)

Caution: In general, boiling water units may vent steam from the tap spout. Take care to avoid personal injury whenever this occurs.

The Zip HydroTap is equipped with a self-calibrating program to adjust for altitude. On start up, the controls take the system through a calibration process. Once this mode is complete the system reverts back to normal operation. If you would like to calibrate the system anytime after initial installation, please follow the steps below.

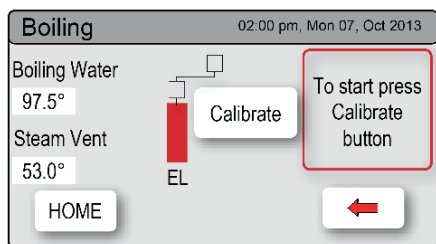

Boiling Calibration Screen

1. Press the [MENU] button for main menu.
2. Press the [Install] button.
3. Press the [Hot Calibration] button.
4. In the next screen, press [Calibrate] if you want to start calibration.

4 - Booster (Boiling models)

This function should only be considered when a Booster unit is installed.

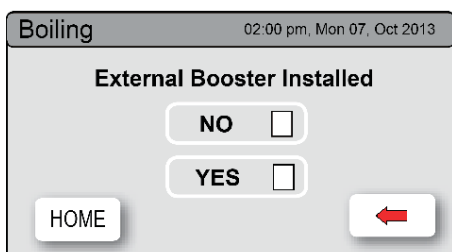

G4 HydroTap Booster Screen

1. Press the [MENU] button for main menu.
2. Press the [Install] button.
3. Press the [Booster] button.
4. If a Booster is installed, select YES to enable the Booster.
5. Dispense boiling water for a minimum of 30 secs and check the outlet hose from the Booster is warm.
6. Otherwise select NO, if no Booster is installed

NOTE: Failing to make the correct selection for 'Booster' will effect product performance.

5 - Lux (light level) Sensor Calibration (All)

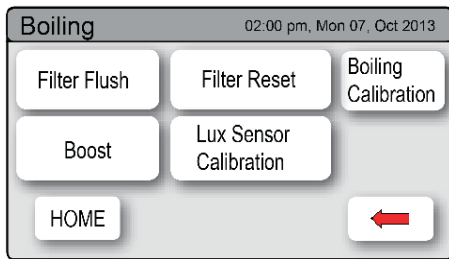

1. Press [MENU] button for main menu.
2. Press [Install] button.
3. Press [Lux Sensor Calibration] button.
4. The lights on the Tap head will flash to confirm calibration.
5. Check for correct tap operation by selecting 'Lux Sensor-> OFF'. When the room is darkened (below the calibrated light level), the tap lights will turn OFF after 24 seconds.

LCD Screen operation - Section D

D Service



Caution must be observed when changing any settings within the Service Menu as any changes may affect the normal operation of the unit. This can only be done by a Zip technician. Please contact your Zip service provider for further assistance.

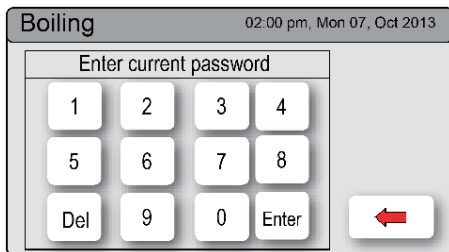

1. Press the [MENU] button for main menu.
2. Press the [Service] button.
3. A password is required to enter service menu.

G4 HydroTap Service Screen

NOTE: In Australia call a licensed electrician, plumber, or Zip office on 1800-638-633, for assistance, service, spare parts, or enquiries.

LCD Screen operation - Section E

E Security

The Zip HydroTap G4 allows the appliance coordinator to set up a password to protect against users changing the preferred system settings.

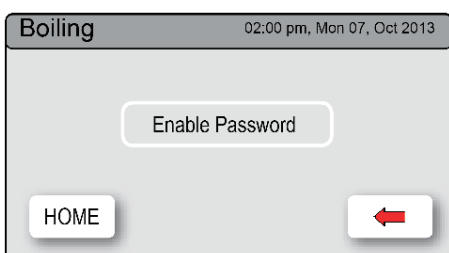

To set a password

1. Press the [MENU] button for main menu.
2. Press the [Security] button.
3. Press [Change Password]
4. Enter a 4 digit password

LCD Screen operation - Section E

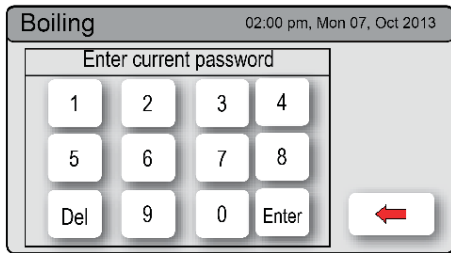

To change a password

1. Press the [MENU] button for main menu.
2. Press the [Security] button.
3. Press [Change Password]
4. Enter your old 4 digit password
5. Then enter your new 4 digit password. You will need to enter your password to access the settings screen. If you have forgotten the password, please disconnect the power and restart your HydroTap unit.

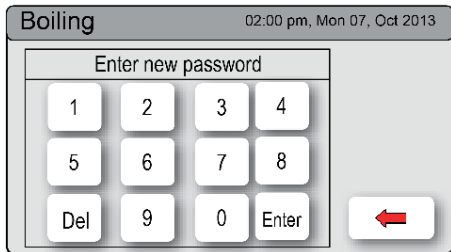

LCD Screen operation - Section F

F Communication (when available)

The Zip HydroTap G4 allows the user to use wifi to monitor & control the product remotely.

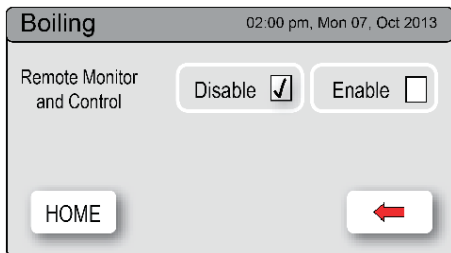

Not yet available

LCD Screen operation - Section G

G Settings (All)

If, in section E, you have set a password, then you will need to enter your password to access the settings screens. If you have forgotten the password, please disconnect the power and restart your HydroTap unit.

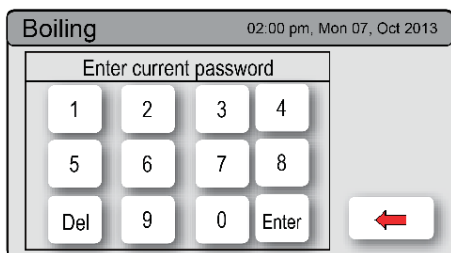

1. Press the [MENU] button for main menu.
2. Press the [Settings] button.
4. Then enter your 4-digit password.

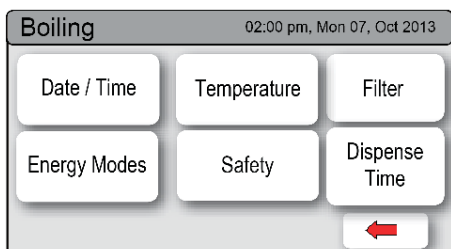

LCD Screen operation - Section G

Set Date / Time

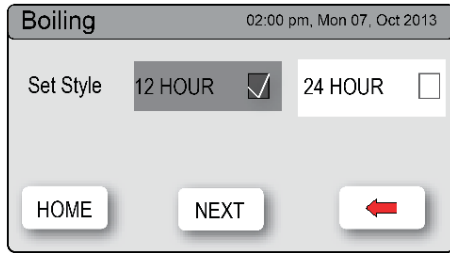

G4 HydroTap Set Date/Time Screen

1. Press the [MENU] button for main menu.
2. Press the [Setting] button.
3. Press the [Date/Time] button.
4. Select either 12 hour or 24 hour mode. The selected mode will be displayed in a dark grey colour with a tick box on the right.
5. Press [NEXT] to set the time and date

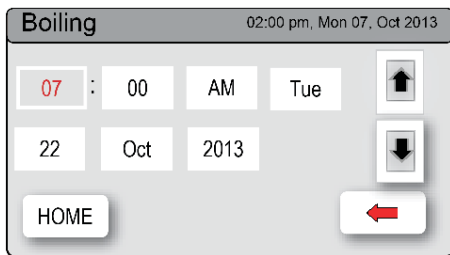

1. Select individually the hour, minutes and day and adjust using the up and down arrows.
2. Select individually the date, month and year and adjust using the up and down arrows.
3. Press [HOME] to return to the Home screen.

Set Temperature

Zip HydroTaps are designed to operate within 1°C to 2°C of set point for boiling water and between 6°C to 10°C (5°C to 10°C for CS175) for chilled drinking water. All boiling water units are self calibrating to 98°C, which is the recommended setting. Adjustments to the 98°C setting are not recommended however, under certain circumstances adjustments may be made between 68° - 100°C. It should be noted that a 20% energy saving in standby power can be achieved when the 98°C setting is selected over the 100°C setting. Furthermore, the 100°C setting is not recommended as the delivery rate of water may be affected.

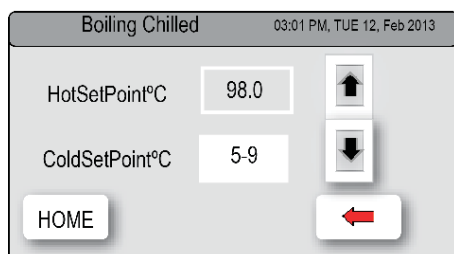

1. Press the [MENU] button for main menu.
2. Press the [Temperature] button.
3. To adjust the temperature, press the relevant temperature button and then use the up and down arrows.
4. Press [HOME] to return to the Home screen.

Filter

Zip HydroTap G4 allows the user to adjust filter life and edit filter usage.

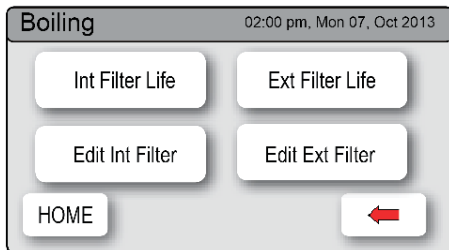

Note: The filter life may be set as a function of Litres used, or in months from the filter change. When the first of these functions is reached (i.e. Litres or months expired), the filter warning light will be illuminated on the tap. Either of these functions may be disabled (See below).

To edit the filter life:

1. Press the [MENU] button for main menu.
2. Press the [Setting] button.
3. Press the [Filter] button.
4. Press the [Filter Life] button, for Internal or External filter.
5. To change filter life, first select filter life (Litres) or filter life (Months), then adjust using the up or down arrows.

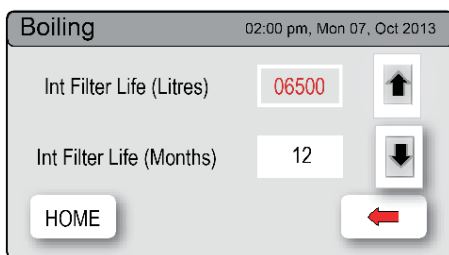

NOTE: Filter Life increases in 500 litre increments to a maximum of 10000 litres. Factory set at 6000 litres.

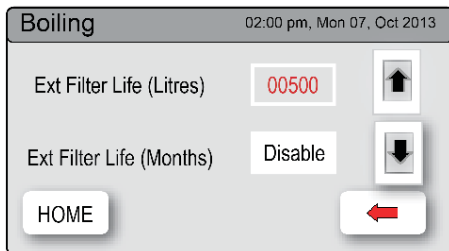

To edit the filter usage:

This function is to reset the Filter Change display after a filter has reached the end of its life (refer to "Replace Filter Instructions" section of this document).

1. Press the [MENU] button for main menu.
2. Press the [Setting] button.
3. Press the [Filter] button.
4. Press the [Edit Filter] button for Internal or External filter.
5. To edit, select Edit Usage (Litres) or Edit Usage (Months), then adjust using the up or down arrows.
6. Press [HOME] to return to the Home screen.

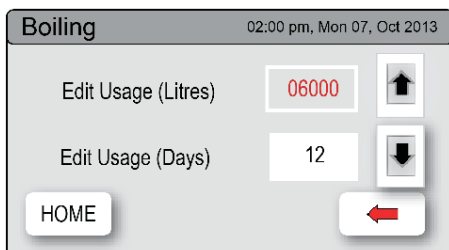

LCD Screen operation - Section G

Energy Modes (Boiling models)

This mode allows the HydroTap to Go into Energy Saving mode. There are two options available: 'Sleep' mode and 'ON/OFF' mode.

In SLEEP MODE the unit will Go to "Sleep" after a 2hr period of inactivity. The Boiling water will gradually drop to either 68°C or room temp, as shown in the table below and the Chilled water will be ON or OFF.

When the period of inactivity passes, the home screen status window will show "Sleep Mode".

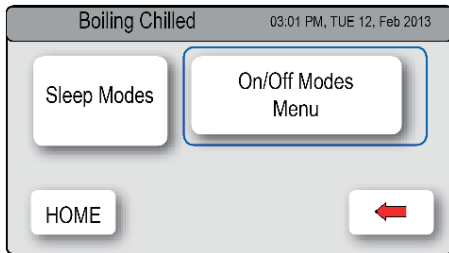

To activate the sleep mode:

1. Press [MENU] button for main menu.
2. Press [Setting] button.
3. If required, Enter your 4 digit password
4. Press [Energy Modes] button.
5. Press [Sleep Modes] button then in the next screen, use the up and down arrows to select one of the 7 options, as shown in the table below.

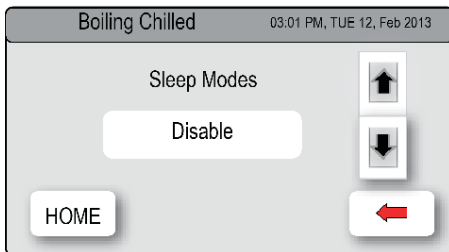

Sleep Mode	Light Level	Time Delay	State	Boiler	Chiller
2 Hours-> 68°C	N/A	2 Hr	Sleep	68°C	ON
2 Hours-> OFF	N/A	2 Hr	OFF	OFF	OFF
Lux Sensor->68°C	Dark	N/A	Sleep	68°C	ON
Lux Sensor-> OFF	Dark	N/A	OFF	OFF	OFF
Lux or 2 Hr-> 68°C	Dark	2 Hr	Sleep	68°C	ON
Lux or 2 Hr-> OFF	Dark	2 Hr	OFF	OFF	OFF
Disable	N/A	N/A	ON	ON	ON

LUX (Light) Sensor Calibration:

It is recommended to recalibrate the Lux Sensor after selecting any of the 4 Lux sensor options from the sleep mode menu. Refer to section C, 5-Lux calibration

NOTE: Any attempt, during OFF mode, to dispense water, will bring the unit out of sleep mode. The unit will return to sleep mode after 2 hours of non use. Please allow sufficient time for the water to reach the set temperature after disabling the sleep mode.

LCD Screen operation - Section G

In **ON / OFF Mode** the user may turn the unit ON or OFF at specific times for individual days or alternatively by weekly and/or weekend settings.

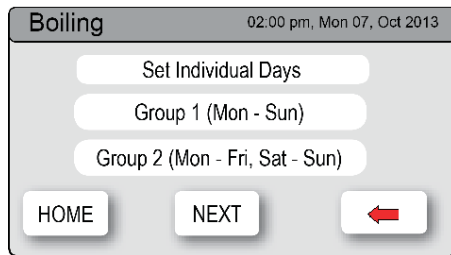

To activate ON/OFF mode:

1. Press the [MENU] button for main menu.
2. Press the [Setting] button.
3. If required, Enter your 4 digit password
4. Press the [Energy Modes] button.
5. Select 'Individual set' if you wish to allocate a specific time for each day.
6. Select 'group set 1' if you wish to allocate the same time to all 7 days
7. Select 'Group set 2' if you wish to allocate the same time to the 5 working days (Mon-Fri) and additional times for (Sat-Sun).

Individual set screen

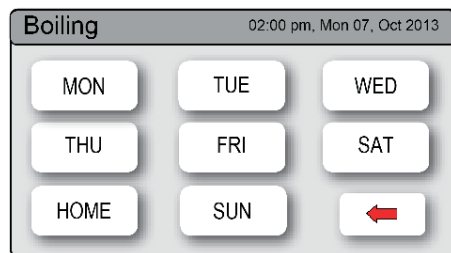

This screen allows you to select the individual days for programming. Only one ON /OFF period is allowed for each day

Group set screen

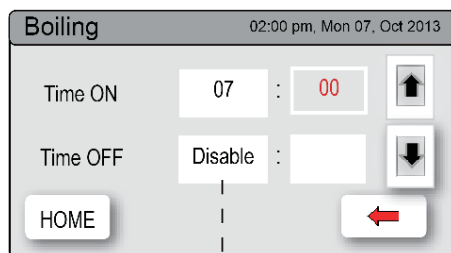

1. Press Group 1 or Group 2 option
2. Press button (A) to enable / disable group set. When the enable box is ticked, this allows each individual day to have an "On/Off" time.
3. Press [ON/OFF Modes] button, to set up ON/OFF time.
4. When in Group 2 Press [NEXT] to select Sat-Sun options

NOTE: Any attempt, during OFF mode, to dispense water, will bring the unit out of energy mode for 30 minutes.

LCD Screen operation - Section G

Safety (Boiling models)

Boiling Only Models

To set the safety using the touch screen:

1. Press the [MENU] button for main menu.
2. Press the [Setting] button.
3. If required, Enter your 4 digit password
4. Press the [Safety] button.
5. Press button (B) to Enable / Disable, the safety lock feature on the tap.

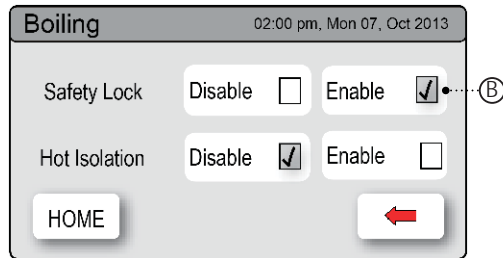

NOTE: When Disabled, boiling water may be dispensed from the Hydrotap by rotating the control anticlockwise.

NOTE: The Hot Isolation function is not actionable for the Celsius range of taps

Dispense Times (All)

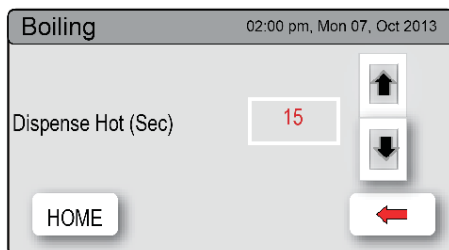

The ability to change the maximum dispensing time for both the Hot and Chilled water has been introduced. The default settings for the maximum dispensing times is 15 seconds. Here, the operator may change both the Hot and Chilled dispensing times to between 5 and 15 seconds, in increments of 1 second.

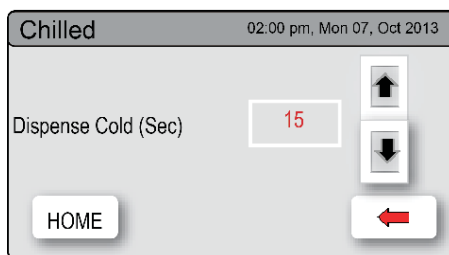

To edit the dispensing times:

1. Press the [MENU] button for main menu.
2. Press the [Setting] button.
3. Press the [Dispense Time] button.
4. Select the option to change and scroll using the up and down arrow Keys.
5. Press [HOME] to return to the Home screen.

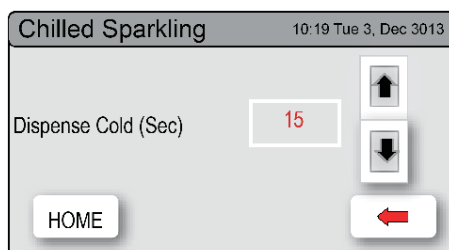

Gas bottle change

1. Turn the CO₂ bottle regulator OFF (Anti-clockwise). The knob will screw up and away from the bottle.
2. Dispense sparkling water for 30 seconds, until the water flow is free of gas.
3. Remove the bottle from the cupboard and disconnect the regulator. If the braided hose is removed from the regulator, be careful not to loose the small plastic sealing olive, located inside the end of the hose.
4. Fit the regulator and hose assembly to the new gas bottle. Be aware that some CO₂ may be discharged from the bottle joint.
5. Fit the bottle in an upright position (use the hook-and-loopsecuring strap).
6. Turn the regulator ON (Clockwise) and adjust to between 2.7- 3.0 bar. (Green zone on dial).
7. Check all joints for gas leaks using a sponge and soapy water.
8. Press the [MENU] button for main menu.
9. Press the [Install] button.
10. Press the [Purge CO₂] button.
11. In the next screen, press the [START] button to commence the purging process.
12. Wait for the water to stop flowing through the unit. Wait a further 5 seconds after the water has stopped flowing. You will hear the CO₂ gas escaping through the tap.
13. Press [STOP] to end the purge
14. Press [=] button for the previous menu or press the [Home] button to return to the home screen.
15. The display screen should revert to Normal operation.
16. Dispense some sparkling water from the tap and perform a taste test.

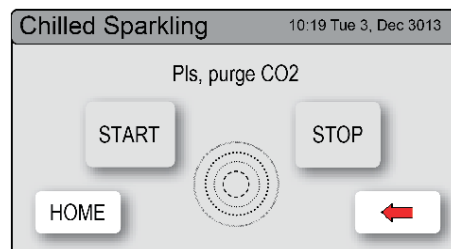
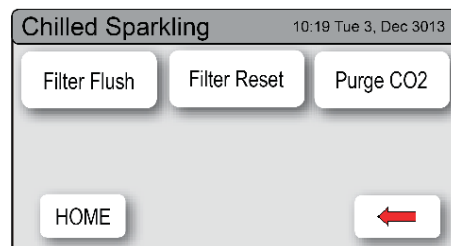

Filter Maintenance

The Zip HydroTap notifies when a filter replacement is due. If you notice one of the following, you will need to change the filter:

- The Change Filter light will flash until reset. (See Section C)
- The filter percentage will change to 0% on the screen.

NOTE: Depending on local water quality conditions and usage, the filter may require changing anywhere from 500 Litres to 10000 Litres. You may also need to replace the filter if you notice unpleasant odours or tastes.

Some water may drip from the filter head (socket) during replacement. Keep a towel handy to dry up any drips.

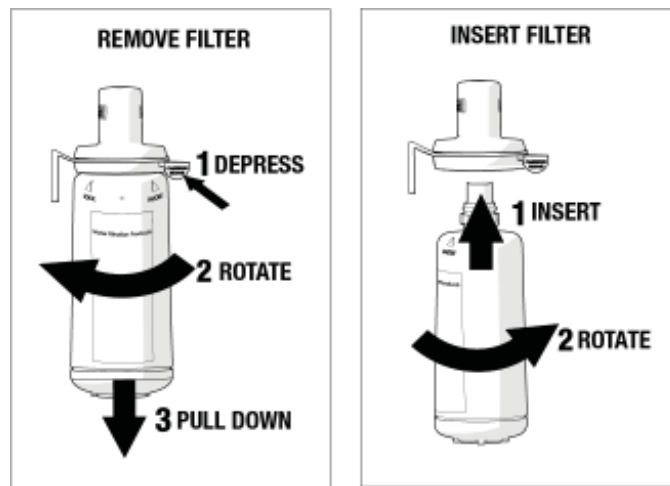

To change the Filter: (See also Section C)

1. Open the door of the under sink unit.
2. Relieve system pressure via the filter flush stop cock, a quick open and close will do. Use the bucket to catch the discharge.
3. Grasp filter cartridge, depress the red lever at the top right of the filter and rotate the cartridge a quarter turn to the left, then gently pull down.
4. **Caution:** a small amount of water will drip as the cartridge is removed.
5. Do not tilt the cartridge as water may spill from it if tilted.
6. Unpack replacement cartridge and remove sanitary cap, write today's date where shown on the label.
7. Avoid touching the filter O-rings and filter opening as this may cause bacterial contamination of the cartridge.
8. Moisten the O-rings with water, align the front cartridge label to the left (as shown in the "insert filter" diagram for filter cartridge replacement), and push the new cartridge into the filter head.
9. Turn the cartridge a quarter turn to the right until the cartridge comes to complete stop and is locked into position, with the front label facing forward.
10. Initiate the filter flush programme by scrolling through the menu screen (See section C).
11. When completed, wipe up any spills and dispose of spent filter cartridge and packaging thoughtfully.
12. Close the door to secure the appliance.
13. Adjust the filter settings in Section G - filter - Litres and Days used.

Filter Maintenance

Warning: If the Zip HydroTap is switched off for a long period of time (e.g. More than a weekend), run water through the chilled water outlet for at least 5 minutes before consumption.

Air Inlet Filter

The Zip HydroTap air filter is conveniently located on the outside of the condenser. The filter screen is a sliding fit in the plastic housing on the side of the under sink unit. The screen may be removed for cleaning, by sliding it forward. This needs to be inspected at least quarterly, cleaned and replaced if damaged.

NOTE: For best performance the unit should only be operated with a clean air filter screen, correctly fitted in place. Maintain, at least, a 50mm air gap in front of the screen at all times. Take care not to allow cloths or other soft materials to accidentally block the air inlet.

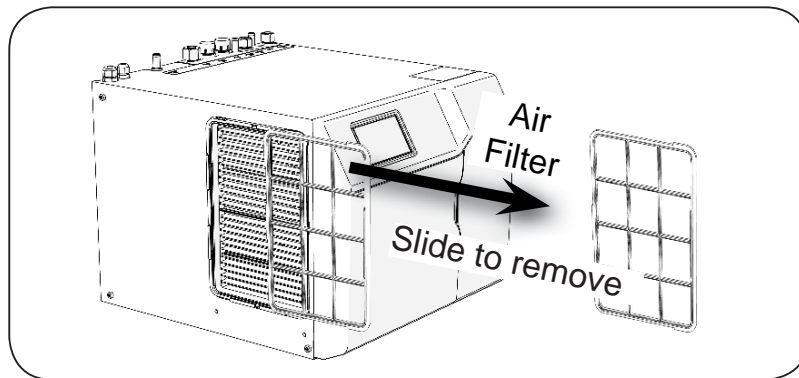

Cleaning

General cleaning

Do not use strong, corrosive, spray or abrasive cleaners. Clean with a soft damp cloth and mild soap.

Under sink units must never be located near, or cleaned with water jets.

Avoid using air borne pesticides near the undersink unit.

Home Menu Icons



Safety switch is LOCKED.

The HydroTap will not dispense any Boiling water. See page 18 for safety switch operation



Safety switch is UNLOCKED.

Boiling water may be dispensed. See page 4 for tap operation details

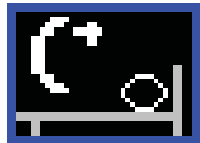

Sleep mode is active.

There are 7 sleep mode options which display this icon on the home screen. See page 16 for details.

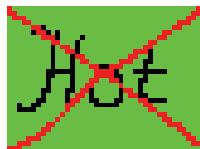

Heater is in OFF mode.

When this icon is displayed, no power is being supplied to the heating element. See pages 16 and 17 for Energy Mode options.



Filter use.

This icon displays the filter usage remaining from 100% (New filter) to 0% (end of life). When it reaches 0% the filter warning light on the tap head will flash slowly.

The filter life can be adjusted by litres and by days used. See page 15



BOILING
98°C

Boiling Temperature

The set temperature of the water in the Boiling tank will be displayed. This is optimised at 98°C but may be adjusted between 68°- 100°. See page 14 for hot set point adjustment.



CHILLED

Chilled Temperature

The set temperature of the water in the Chiller tank will be displayed. This will range from 6-10°C (CHA) and 5-10°C (CSHA)

NOTES

Head Office

Zip Heaters (Aust) Pty. Ltd.
ABN: 46 000 578 727
67 Allingham Street
Condell Park NSW 2200
Postal: Locked Bag 80
Bankstown 1885 Australia

Website: www.zipindustries.com

Facsimile: (02) 9796 3858
Telephone: (02) 9796 3100
Sales & Service.
Free Call: 1 800 63 86 33
Customer Care.
Free Call: 1 800 42 43 44

As Zip policy is one of continuous product improvement, changes to specifications may be made without prior notice. Images in this booklet have been modified and may not be true representations of the finished goods.



WaterMark
WMK25927
AS/NZS 3718



WaterMark
WMKA00099
AS 3498



The terms "Zip" and "Celsius" are registered trade marks of Zip Heaters (Aust) Pty Ltd. Zip products described in this publication are manufactured under one or more of the following patents: AU675601, AU637412, AU635979, GB0422305, GB2065848, US4354049, US5103859, US5099825 and SA2006/08043. Other patents are in force and patent applications are pending.

