



## MICROWAVE / WALL OVEN COMBINATION

Use & Care Guide

## COMBINACIÓN MICROONDAS / HORNO DE PARED

Manual del Usuario

Models, Modelos

790.4784\*, 4785\*

\* = Color number,  
número de color



ENGLISH

ESPAÑOL

# Table of Contents

Wall Oven Warranty .....	2	Wall Oven Vent and Racks .....	17
Product Record .....	2	Air Circulation in the Oven .....	17
Serial Plate Location .....	2	Wall Oven Control Pad Features .....	18
IMPORTANT SAFETY INSTRUCTIONS .....	3-5	Setting the Wall Oven Clock .....	19
Protection Agreements .....	6	Setting the Wall Oven Controls .....	20-26
Wall Oven Features .....	7	Wall Oven Self-Cleaning Cycle .....	27-28
Microwave Oven Important Informations .....	8-9	Microwave General Care & Cleaning .....	29
Microwave Oven Control Pad Features .....	10	Wall Oven General Care & Cleaning .....	30-31
Before Operating the Microwave .....	10	Adjusting the Oven Temperature .....	32
Microwave Manual Operation .....	10-11	Before You Call .....	33-34
Microwave Operating Instructions .....	11-16	Notes .....	35
		Sears Service .....	36

## Please carefully read and save these instructions

This Use & Care Manual contains general operating instructions for your appliance and feature information for several models. Your product **may not** have all the described features. The graphics shown are representative. The graphics on your appliance may not look exactly like those shown. Common sense and caution must be practiced when installing, operating and maintaining any appliance.

### Kenmore Warranty

When installed, operated and maintained according to all instructions supplied with the product, if this appliance fails due to a defect in material and workmanship within one year from the date of purchase, call 1-800-4-MY-HOME® to arrange for free repair.

This warranty applies for only 90 days from the date of purchase if this appliance is ever used for other than private family purposes.

#### This warranty covers only defects in material and workmanship. Sears will NOT pay for:

1. Cracks in a ceramic glass cooktop that are not a result of thermal shock.
2. Stains and scratches on a ceramic glass cooktop resulting from accident or improper operation or maintenance.
3. Expendable items that can wear out from normal use, including but not limited to filters, belts, light bulbs, and bags.
4. A service technician to instruct the user in correct product installation, operation or maintenance.
5. A service technician to clean or maintain this product.
6. Damage to or failure of this product if it is not installed, operated or maintained according to the all instructions supplied with the product.
7. Damage to or failure of this product resulting from accident, abuse, misuse or use for other than its intended purpose.
8. Damage to or failure of this product caused by the use of detergents, cleaners, chemicals or utensils other than those recommended in all instructions supplied with the product.
9. Damage to or failure of parts or systems resulting from unauthorized modifications made to this product.

#### Disclaimer of implied warranties; limitation of remedies

Customer's sole and exclusive remedy under this limited warranty shall be product repair as provided herein. Implied warranties, including warranties of merchantability or fitness for a particular purpose, are limited to one year or the shortest period allowed by law. Sears shall not be liable for incidental or consequential damages. Some states and provinces do not allow the exclusion or limitation of incidental or consequential damages, or limitation on the duration of implied warranties of merchantability or fitness, so these exclusions or limitations may not apply to you.

This warranty applies only while this appliance is used in the United States or Canada.

This warranty gives you specific legal rights, and you may also have other rights which vary from state to state.

**Sears, Roebuck and Co., Hoffman Estates, IL 60179**  
**Sears Canada Inc., Toronto, Ontario, Canada M5B 2B8**

## Product Record

In this space below, record the date of purchase, model and serial number of your product. You will find the model and serial number printed on the serial plate.

Model No. **790.** \_\_\_\_\_

Serial No. \_\_\_\_\_

Date of purchase \_\_\_\_\_

Save these instructions and your sales receipt for future reference.

## Serial Plate Location

You will find the model and serial number printed on the serial plate. The serial plate is located along the interior side trim and visible when the oven door is opened.

Remember to record the serial number for future reference.

**Serial Plate Location**

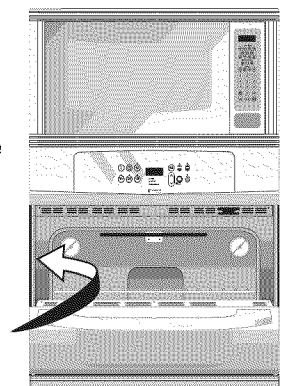

# IMPORTANT SAFETY INSTRUCTIONS

## SAVE THESE INSTRUCTIONS FOR FUTURE REFERENCE.

Read all instructions before using this appliance.

This manual contains important safety symbols and instructions. Please pay attention to these symbols and follow all instructions given.

**⚠ WARNING** This symbol will help alert you to situations that may cause serious bodily harm, death or property damage.

**⚠ CAUTION** This symbol will help alert you to situations that may cause bodily injury or property damage.

### **⚠ PRECAUTIONS TO AVOID POSSIBLE EXPOSURE TO EXCESSIVE MICROWAVE ENERGY**

For your safety the information in this manual must be followed to minimize the risk of fire or explosion or to prevent property damage, personal injury or loss of life.

- **Do Not Attempt** to operate this microwave oven with the door open since open-door operation can result in harmful exposure to microwave energy. It is important not to defeat or tamper with the safety interlocks.
  - **Do Not Place** any object between the microwave oven front face and the door or allow soil or cleaner residue to accumulate on sealing surfaces.
  - **Do Not Operate** the microwave oven if it is damaged. It is particularly important that the microwave oven door close properly and that there is no damage to the:
    1. door (bent)
    2. hinges and latches (broken or loosened)
    3. door seals and sealing surfaces.
  - **The Microwave Oven Should Not** be adjusted or repaired by anyone except properly qualified service personnel.
- **Remove all tape and packaging before using the appliance.** Destroy the carton and plastic bags after unpacking the appliance. Never allow children to play with packaging material.
  - **Proper Installation. Be sure your appliance is properly installed and grounded by a qualified technician in accordance with National Electrical Code ANSI/NFPA No.70 (USA) or CSA C22.1, PART 1 (Canada)-latest edition and local code requirements.** Install only per installation instructions provided in the literature package for this appliance.

Sears Parts & Repair is the recommended repair service for this appliance. Know how to disconnect the electrical power to the appliance at the circuit breaker or fuse box in case of an emergency.



#### **⚠ WARNING**

- All wall ovens can tip.
- Injury to persons could result.
- Install mounting bracket packed with wall oven.
- See Installation Instructions.



To reduce the risk of tipping, the wall oven must be secured by properly installed mounting bracket provided with the wall oven. Refer to the Installation Instructions for proper mounting bracket installation.

**⚠ CAUTION** Electronic controllers can be damaged by cold temperatures. When you use your appliance for the first time, or if it has not been used for a long period of time, make sure that it has been exposed to a temperature above 0°C/32°F for at least 3 hours before connecting it to the power supply.

- **User Servicing. Do not repair or replace any part of the appliance unless specifically recommended in the manuals.** All other servicing should be done only by a qualified technician to reduce the risk of personal injury and damage to the appliance.

- **Never modify or alter the construction of an appliance by removing panels, wire covers or any other part of the product.**

- **Remove the oven door from any unused appliance if it is to be stored or discarded.**

**⚠ WARNING** Stepping, leaning, sitting or pulling down on the door of this appliance can result in serious injuries and may also cause damage to the appliance. Do not allow children to climb or play around the appliance.

- **Storage on Appliance. Flammable materials should not be stored near surface units.** This includes paper, plastic and cloth items, such as cookbooks, plasticware and towels, as well as flammable liquids. Do not store explosives, such as aerosol cans, on or near the appliance. Flammable materials may explode and result in fire or property damage.

# IMPORTANT SAFETY INSTRUCTIONS

**⚠ WARNING** Do not use the oven for storage.

**⚠ CAUTION** Do not store items of interest to children in the cabinets above an appliance. Children climbing on the appliance to reach items could be seriously injured.

- **Do not leave children alone. Children should not be left alone or unattended in the area where an appliance is in use.** They should never be allowed to sit or stand on any part of the appliance.
- **DO NOT TOUCH HEATING ELEMENTS OR INTERIOR SURFACES OF OVEN.** Heating elements may be hot even though they are dark in color. Interior surfaces of an oven become hot enough to cause burns. During and after use, do not touch, or let clothing or other flammable materials contact heating elements or interior surfaces of oven until they have had sufficient time to cool. Other surfaces of the appliance may become hot enough to cause burns - among these surfaces are (identification of surfaces- for example, oven vent openings and surfaces near these openings, oven doors, and windows of the oven doors).
- **Wear Proper Apparel. Loose-fitting or hanging garments should never be worn while using the appliance.** Do not let clothing or other flammable materials contact hot surfaces.

**⚠ WARNING** Never use your appliance for warming or heating the room.

- **Do Not Use Water or Flour on Grease Fires.** Smother the fire with a pan lid, or use baking soda, a dry chemical or foam-type extinguisher.
- **When heating fat or grease, watch it closely.** Fat or grease may catch fire if allowed to become too hot.
- **Use Only Dry Potholders. Moist or damp potholders on hot surfaces may result in burns from steam.** Do not let the potholders touch hot heating surface units. Do not use a towel or other bulky cloth instead of a potholder.
- **Do Not Heat Unopened Food Containers. Buildup of pressure may cause the container to burst and result in injury.**

**IMPORTANT—Do not attempt to operate the appliance during a power failure.** If power fails, always turn off the appliance. If the appliance is not turned off and the power resumes, it will begin to operate again. Once the power resumes, reset the clock and oven function.

## IMPORTANT INSTRUCTIONS FOR USING YOUR MICROWAVE

**⚠ WARNING** To reduce the risk of fire, burns, electric shock, injury to persons, or exposure to excessive microwave energy when using your appliance, follow basic *precautions, including the following sections.*

- Read all instructions before using the appliance.
- Read and follow the specific “**PRECAUTIONS TO AVOID POSSIBLE EXPOSURE TO EXCESSIVE MICROWAVE ENERGY**” on page 3.
- Some products such as whole eggs and sealed containers—for example, closed glass jars—are able to explode and should not be heated in this microwave oven.
- Use this appliance only for its intended use as described in this manual. Do not use corrosive chemicals or vapors in this appliance. This type of microwave oven is specifically designed to heat, cook or dry food. It is not designed for industrial or laboratory use.
- As with any appliance, close supervision is necessary when used by children.
- Do not operate this appliance if it is not working properly or if it has been damaged or dropped.
- Do not cover or block any openings on the appliance.
- Do not store or use this appliance outdoors. Do not use this product near water—for example, near a kitchen sink, in a wet basement or near a swimming pool, or similar locations.
- See door surface cleaning instructions on page 29.
- To reduce the risk of fire in the microwave oven cavity:
  - Do not overcook food. Carefully attend appliance when paper, plastic or other combustible materials are placed inside the microwave oven to facilitate cooking.
  - Remove wire twist-ties from paper or plastic bags before placing bag in microwave oven.
  - **If materials inside the microwave oven should ignite, keep microwave oven door closed, turn microwave oven off and disconnect the power cord or shut off power at the fuse or circuit breaker panel.**
  - Do not use the cavity for storage purposes. Do not leave paper products, cooking utensils or food in the cavity when not in use.

# IMPORTANT SAFETY INSTRUCTIONS

- Liquids, such as water, coffee or tea are able to be overheated beyond the boiling point without appearing to be boiling. Visible bubbling or boiling when the container is removed from the microwave oven is not always present. **THIS COULD RESULT IN VERY HOT LIQUIDS SUDDENLY BOILING OVER WHEN A SPOON OR OTHER UTENSIL IS INSERTED INTO THE LIQUID.**

To reduce the risk of injury to persons:

- Do not overheat the liquid.
  - Stir the liquid both before and halfway through heating it.
  - Do not use straight-sided containers with narrow necks. Use a wide-mouthed container.
  - After heating, allow the container to stand in the microwave oven at least for 20 seconds before removing the container.
  - Use extreme care when inserting a spoon or other utensil into the container.
- If the microwave oven light fails, consult a Sears parts & repair center.

## IMPORTANT INSTRUCTIONS FOR USING YOUR WALL OVEN

- **Use Care When Opening an Oven Door**—Stand to the side of the appliance when opening the door of a hot oven. Let hot air or steam escape before you remove or replace food in the oven.
- **Keep Oven Vent Ducts Unobstructed.** The wall oven is vented at the upper control panel or at the center trim depending of the model. Touching the surfaces in this area when the wall oven is operating may cause severe burns. Also, do not place plastic or heat-sensitive items near the oven vent. These items could melt or ignite.
- **Placement of Oven Racks.** Always place oven racks in desired location while oven is cool. Remove all utensils from the rack before removing rack. If rack must be moved while oven is hot, use extreme caution. Use pot holders and grasp the rack with both hands to reposition. Do not let pot holders contact the hot oven element or interior of the oven.
- **Do not use a broiler pan without its insert.** Broiler pan and grid allow dripping fat to drain and be kept away from the high heat of the broiler.
- **Do not cover the broiler grid or oven bottom with aluminum foil.** Exposed fat and grease could ignite.
- **Do not touch a hot oven light bulb with a damp cloth.** Doing so could cause the bulb to break. Disconnect the appliance or shut off the power to the appliance before removing and replacing the bulb.

- **Protective liners**—Do not use aluminum foil to line the oven bottom. Only use aluminum foil as recommended in this manual. Improper installation of these liners may result in risk of electric shock, or fire.

## IMPORTANT INSTRUCTIONS FOR CLEANING YOUR WALL OVEN

- **Clean the appliance regularly to keep all parts free of grease that could catch fire.** Exhaust fan ventilation hoods and grease filters should be kept clean. Do not allow grease to accumulate. Greasy deposits in the fan could catch fire. Refer to the hood manufacturer's instructions for cleaning.

## SELF-CLEANING WALL OVEN MODELS

- **Clean in the self-cleaning cycle only the parts of the appliance listed in this Owner's Guide.** Before using the self-cleaning cycle of the appliance, remove all utensils stored in the appliance.
- **Do not clean the oven door gasket.** The door gasket is essential for a good seal. Care should be taken not to rub, damage or move the gasket.
- **Do not use oven cleaners.** No oven cleaner or oven liner protective coating of any kind should be used in or around any part of the appliance

**CAUTION** The health of some birds is extremely sensitive to the fumes given off during the self-clean cycle of any wall oven. Move birds to another well ventilated room.

---

## IMPORTANT SAFETY NOTICE

The California Safe Drinking Water and Toxic Enforcement Act requires the Governor of California to publish a list of substances known to the state to cause cancer, birth defects or other productive harm, and requires businesses to warn customers of potential exposure to such substances.

---

# PROTECTION AGREEMENTS

## Master Protection Agreements

*Congratulations on making a smart purchase. Your new Kenmore® product is designed and manufactured for years of dependable operation. But like all products, it may require preventive maintenance or repair from time to time. That's when having a Master Protection Agreement can save you money and aggravation.*

The Master Protection Agreement also helps extend the life of your new product. Here's what the Agreement\* includes:

- ☑ **Parts and labor** needed to help keep products operating properly **under normal use**, not just defects. Our coverage goes **well beyond the product warranty**. No deductibles, no functional failure excluded from coverage – **real protection**.
- ☑ **Expert service** by a force of more than **10,000 authorized Sears service technicians**, which means someone you can trust will be working on your product.
- ☑ **Unlimited service calls and nationwide service**, as often as you want us, whenever you want us.
- ☑ **«No-lemon» guarantee** – replacement of your covered product if four or more product failures occur within twelve months.
- ☑ **Product replacement** if your covered product can't be fixed.
- ☑ **Annual Preventive Maintenance Check** at your request – no extra charge.
- ☑ **Fast help by phone** – we call it **Rapid Resolution** – phone support from a Sears representative on all products. Think of us as a «talking owner's manual».
- ☑ **Power surge protection** against electrical damage due to power fluctuations.
- ☑ **\$250 Food Loss Protection** annually for any food spoilage that is the result of mechanical failure of any covered refrigerator or freezer.
- ☑ **Rental reimbursement** if repair of your covered product takes longer than promised.
- ☑ **10% discount** off the regular price of any non-covered repair service and related installed parts.

Once you purchase the Agreement, a simple phone call is all that it takes for you to schedule service. You can call anytime day or night, or schedule a service appointment online.

The Master Protection Agreement is a risk free purchase. If you cancel for any reason during the product warranty period, we will provide a full refund. Or, a prorated refund anytime after the product warranty period expires. Purchase your Master Protection Agreement today!

**Some limitations and exclusions apply. For prices and additional information in the U.S.A. call 1-800-827-6655.**

**\* Coverage in Canada varies on some items. For full details call Sears Canada at 1-800-361-6665.**

## Sears Installation Service

*For Sears professional installation of home appliances, garage door openers, water heaters, and other major home items, in the U.S.A. or Canada call **1-800-4-MY-HOME**®.*

## Acuerdos maestros de protección

*Enhorabuena por haber hecho una compra inteligente. Su nuevo producto Kenmore® está diseñado y fabricado para brindarle años de funcionamiento fiable. Pero, como cualquier producto, puede necesitar mantenimiento preventivo o reparaciones periódicas. Es por eso que tener un Acuerdo maestro de protección podría ahorrarle dinero y molestias.*

El Acuerdo maestro de protección también sirve para prolongar la durabilidad de su nuevo producto. El acuerdo\* incluye lo siguiente:

- ☑ **Piezas y mano de obra** necesarias para contribuir a mantener el funcionamiento adecuado de los productos **utilizados en condiciones normales de uso**, no sólo en caso de defectos de los productos. Nuestra cobertura va **mucho más allá que la garantía del producto**. No se aplican deducibles ni exclusiones por fallas del funcionamiento: es decir, **verdadera protección**.
- ☑ **Servicio técnico por expertos** (más de **10000 técnicos autorizados de Sears**), lo cual significa que quien repare o realice el mantenimiento de su producto será un profesional de confianza.
- ☑ **Servicio técnico a escala nacional y número ilimitado de llamadas de solicitud de servicio técnico**: se puede poner en contacto con nosotros cuantas veces lo desee y cuando lo desee.
- ☑ **Garantía «sin sorpresas»**: se reemplaza el producto cubierto por el acuerdo si ocurren cuatro o más fallas del producto en un periodo de 12 meses.
- ☑ **Reemplazo del producto**: en caso de que no se pueda reparar el producto cubierto por el acuerdo.
- ☑ **Revisión anual preventiva de mantenimiento del producto**: puede solicitarla en cualquier momento, sin costo alguno.
- ☑ **Rápida asistencia telefónica**, la cual denominamos **Solución rápida**: es decir, asistencia telefónica a través de cualquiera de nuestros representantes de Sears, sobre cualquiera de nuestros productos. Piense en nosotros como en un «manual parlante del usuario».
- ☑ **Protección contra fallas eléctricas**, contra daños debidos a fluctuaciones de la corriente eléctrica.
- ☑ **\$250 al año para cubrir cualquier posible deterioro de alimentos** que haya tenido que desechar debido a una falla mecánica de cualquiera de nuestros refrigeradores o congeladores cubiertos por este acuerdo.
- ☑ **Devolución de gastos de alquiler de electrodomésticos** si la reparación de su producto asegurado toma más que el tiempo prometido.
- ☑ **10% de descuento** aplicable tanto a los costos del servicio de reparación, como de las piezas instaladas relacionadas que no hayan quedado cubiertos por este acuerdo.

Una vez que haya realizado el pago de este acuerdo, bastará una simple llamada telefónica para concertar una visita de servicio. Puede llamar a cualquier hora del día o de la noche, o bien concertar una visita de servicio por Internet.

La adquisición del Acuerdo maestro de protección es una inversión exenta de riesgos. Si por cualquier motivo decide cancelar dicho acuerdo durante el periodo de garantía del producto, le haremos un reintegro total del valor. O bien un importe proporcional si cancela el acuerdo en cualquier otro momento posterior al vencimiento del periodo de garantía del producto. ¡Adquiera hoy mismo su Acuerdo maestro de protección!

**Algunas limitaciones y exclusiones podrían aplicarse. Para solicitar precios e información adicional, llame al 1-800-827-6655 (en los EE.UU.).**

**\* La cobertura en Canadá varía en el caso de algunos artículos. Para obtener detalles completos al respecto, llame al 1-800-361-6665 de Sears de Canadá.**

## Servicio de instalación de Sears

*Para solicitar la instalación por profesionales de Sears de electrodomésticos, abridores de puertas de garaje, calentadores de agua y otros artículos de uso prioritario en el hogar, llame al **1-800-4-MY-HOME** en los EE.UU. o Canadá.*

# Microwave / Wall Oven Features

Note: The features of your oven will vary according to model.

## Your Microwave / Wall Oven Features At A Glance

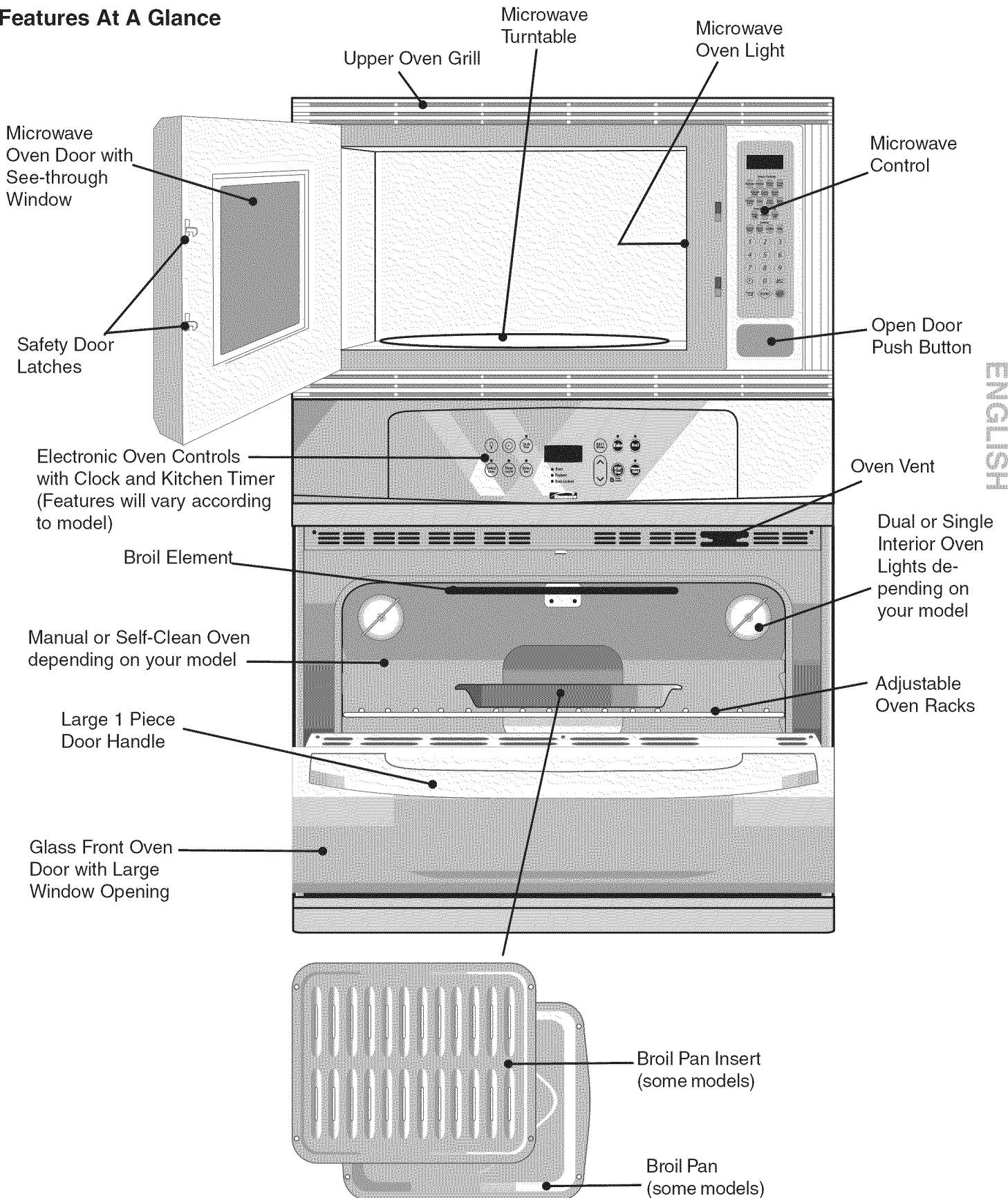

ENGLISH

# Microwave Oven Important Information

## Radio or TV Interference

Should there be any interference caused by the microwave oven to your radio or TV, check that the microwave oven is on a different electrical circuit, relocate the radio or TV as far away from the microwave oven as feasible or check position and signal of receiving antenna.

## ABOUT YOUR MICROWAVE OVEN

This Use and Care Manual is valuable: read it carefully and always save it for reference.

A good microwave cookbook is a valuable asset. Check it for microwave cooking principles, techniques, hints and recipes.

**NEVER** use the microwave oven without the turntable and support nor turn the turntable over so that a large dish could be placed in the microwave oven. The turntable will turn both clockwise and counterclockwise.

**ALWAYS** have food in the microwave oven when it is on to absorb the microwave energy.

When using the microwave oven at power levels below 100%, you may hear the magnetron cycling on and off. It is normal for the exterior of the microwave oven to be warm to the touch when cooking or reheating.

Condensation is a normal part of microwave cooking. Room humidity and the moisture in food will influence the amount of moisture that condenses in the microwave oven. Generally, covered foods will not cause as much condensation as uncovered ones. Ventilation openings must not be blocked. The microwave oven is for food preparation only. It should not be used to dry clothes or newspapers.

All microwave ovens are rated by using the IEC Test Procedure at 1200 watts. In using recipes or package directions, check food a minute or two before the minimum time setting elapses and add time accordingly.

## ABOUT MICROWAVE COOKING

- Arrange food carefully. Place thickest areas towards outside of dish.
- Watch cooking time. Cook for the shortest amount of time indicated and add more as needed. Food severely overcooked can smoke or ignite.
- Cover foods while cooking. Check recipe or cookbook for suggestions: paper towels, wax paper, microwave plastic wrap or a lid. Covers prevent spattering and help foods to cook evenly.
- Shield with small flat pieces of aluminum foil any thin areas of meat or poultry to prevent overcooking before dense, thick areas are cooked thoroughly.
- Stir foods from outside to center of dish once or twice during cooking, if possible.
- Turn foods over once during microwaving to speed cooking of such foods as chicken and hamburgers. Large items like roasts must be turned over at least once.
- Rearrange foods such as meatballs halfway through cooking both from top to bottom and from the center of the dish to the outside.
- Use standing time. Always allow food to stand in or out of the oven after cooking power stops. Standing time after defrosting or cooking allows the temperature to evenly spread throughout the food, improving the cooking results. For inside oven standing time, you can program a "0" power

stage of cooking cycle. See Multiple Stage Cooking.

- Check for doneness. Look for signs indicating that cooking temperatures have been reached.

### Doneness signs include:

- Food steams throughout, not just at edge.
- Center bottom of dish is very hot to the touch.
- Poultry thigh joints move easily.
- Meat and poultry show no pinkness.
- Fish is opaque and flakes easily with a fork.

## ABOUT FOODS

- Do not pop popcorn in your microwave oven unless in a special microwave popcorn accessory or unless you use popcorn labeled for use in microwave ovens.
- Some products such as whole eggs and sealed containers—for example, closed jars—will explode and should not be heated in this microwave oven. Such use of the microwave oven could result in injury.
- Do not boil eggs in a microwave oven. Pressure will build up inside egg yolk and will cause it to burst, possibly resulting in injury.
- Operating the microwave with no food inside for more than a minute or two may cause damage to the microwave oven and could start a fire. It increases the heat around the magnetron and can shorten the life of the microwave oven.
- Foods with unbroken outer "skin" such as potatoes, hot dogs, sausages, tomatoes, apples, chicken livers and other giblets, and egg yolks should be pierced to allow steam to escape during cooking.
- Avoid heating baby food in glass jars, even with the lid off. Make sure all infant food is thoroughly cooked. Stir food to distribute the heat evenly. Be careful to prevent scalding when warming formula or breast milk. The container may feel cooler than the milk really is. Always test the milk before feeding the baby.
- Spontaneous boiling—Under certain special circumstances, liquids may start to boil during or shortly after removal from the microwave oven. To prevent burns from splashing liquid, we recommend the following: before removing the container from the microwave oven, allow the container to stand in the microwave oven for 30 to 40 seconds after the microwave oven has shut off. Do not boil liquids in narrow-necked containers such as soft drink bottles, wine flasks and especially narrow-necked coffee cups. Even if the container is opened, excessive steam can build up and cause it to burst or overflow.
- Do not defrost frozen beverages in narrow-necked bottles (especially carbonated beverages). Even if the container is opened, pressure can build up. This can cause the container to burst, possibly resulting in injury.
- Hot foods and steam can cause burns. Be careful when opening any containers of hot food, including popcorn bags, cooking pouches and boxes. To prevent possible injury, direct steam away from hands and face.
- Do not overcook potatoes. They could dehydrate and catch fire, causing damage to your microwave oven.
- Cook meat and poultry thoroughly—meat to at least an INTERNAL temperature of 160½F and poultry to at least an INTERNAL temperature of 170½F. Cooking to these temperatures usually protects against foodborne illness.

# Microwave Oven Important Information (continued)

## ABOUT UTENSILS AND COVERINGS

It is not necessary to buy all new cookware. Many pieces already in your kitchen can be used successfully in your new microwave oven. Make sure the utensil does not touch the interior walls during cooking.

**Use these utensils for safe microwave cooking and reheating:**

- glass ceramic (Pyroceram®), such as Corningware®.
- heat-resistant glass (Pyrex®)
- microwave-safe plastics
- paper plates
- microwave-safe pottery, stoneware and porcelain
- browning dish (Do not exceed recommended preheating time. Follow manufacturer's directions.)

**These items can be used for short time reheating of foods that have little fat or sugar in them:**

- wood, straw, wicker

## DO NOT USE

- metal pans and bakeware
- dishes with metallic trim
- non-heat-resistant glass
- non-microwave-safe plastics (margarine tubs)
- recycled paper products
- brown paper bags
- food storage bags
- metal twist-ties

Should you wish to check if a dish is safe for microwaving, place the empty dish in the microwave oven and microwave on HIGH for 30 seconds. A dish which becomes very hot should not be used.

## The following coverings are ideal:

- Paper towels are good for covering foods for reheating and absorbing fat while cooking bacon.
- Wax paper can be used for cooking and reheating.
- Plastic wrap that is specially marked for microwave use can be used for cooking and reheating. DO NOT allow plastic wrap to touch food. Vent so steam can escape.
- Lids that are microwave-safe are a good choice because heat is kept near the food to hasten cooking.
- Oven cooking bags are good for large meats or foods that need tenderizing. DO NOT use metal twist ties. Remember to slit bag so steam can escape.

## How to use aluminum foil in your microwave oven:

- Small flat pieces of aluminum foil placed smoothly on the food can be used to shield areas that are either defrosting or cooking too quickly.
- Foil should not come closer than one inch to any surface of the microwave oven.

Should you have questions about utensils or coverings, check a good microwave cookbook or follow recipe suggestions.

**ACCESSORIES** There are many microwave accessories available for purchase. Evaluate carefully before you purchase so that they meet your needs. A microwave-safe thermometer will assist you in determining correct doneness and assure you

that foods have been cooked to safe temperatures. Sears is not responsible for any damage to the microwave oven when accessories are used.

## ABOUT CHILDREN AND THE MICROWAVE

Children below the age of 7 should use the microwave oven with a supervising person very near to them. Between the ages of 7 and 12, the supervising person should be in the same room.

At no time should anyone be allowed to lean or swing on the microwave oven door.

Children should be taught all safety precautions: use potholders, remove coverings carefully, pay special attention to packages that crisp food because they may be extra hot. Don't assume that because a child has mastered one cooking skill he/she can cook everything.

Children need to learn that the microwave oven is not a toy. See page 15 for Child Lock feature.

## ABOUT SAFETY

- Check foods to see that they are cooked to the United States Department of Agriculture's recommended temperatures.

---

160½F - For fresh pork, ground meat, boneless white poultry, fish, seafood, egg dishes and frozen prepared food.

---

165½F - For leftover, ready-to-reheat refrigerated, and deli and carry-out "fresh" food.

---

170½F - White meat of poultry.

---

175½F - Dark meat of poultry.

---

To test for doneness, insert a meat thermometer in a thick or dense area away from fat or bone. NEVER leave the thermometer in the food during cooking, unless it is approved for microwave oven use.

- ALWAYS use potholders to prevent burns when handling utensils that are in contact with hot food. Enough heat from the food can transfer through utensils to cause skin burns.
- Avoid steam burns by directing steam away from the face and hands. Slowly lift the farthest edge of a dish's covering and carefully open popcorn and oven cooking bags away from the face.
- Stay near the microwave oven while it's in use and check cooking progress frequently so that there is no chance of overcooking food.
- NEVER use the cavity for storing cookbooks or other items.
- Select, store and handle food carefully to preserve its high quality and minimize the spread of foodborne bacteria.
- Keep waveguide cover clean. Food residue can cause arcing and/or fires.
- Use care when removing items from the microwave oven so that the utensil, your clothes or accessories do not touch the safety door latches.

# Microwave Oven Control Pad Features

**READ THE INSTRUCTIONS CAREFULLY BEFORE USING THE OVEN.**

The 7-digit Interactive Display spells out operating steps and shows cooking hints. When HELP is lighted in the display, touch the **HELP** pad to read a specific hint which may assist you.

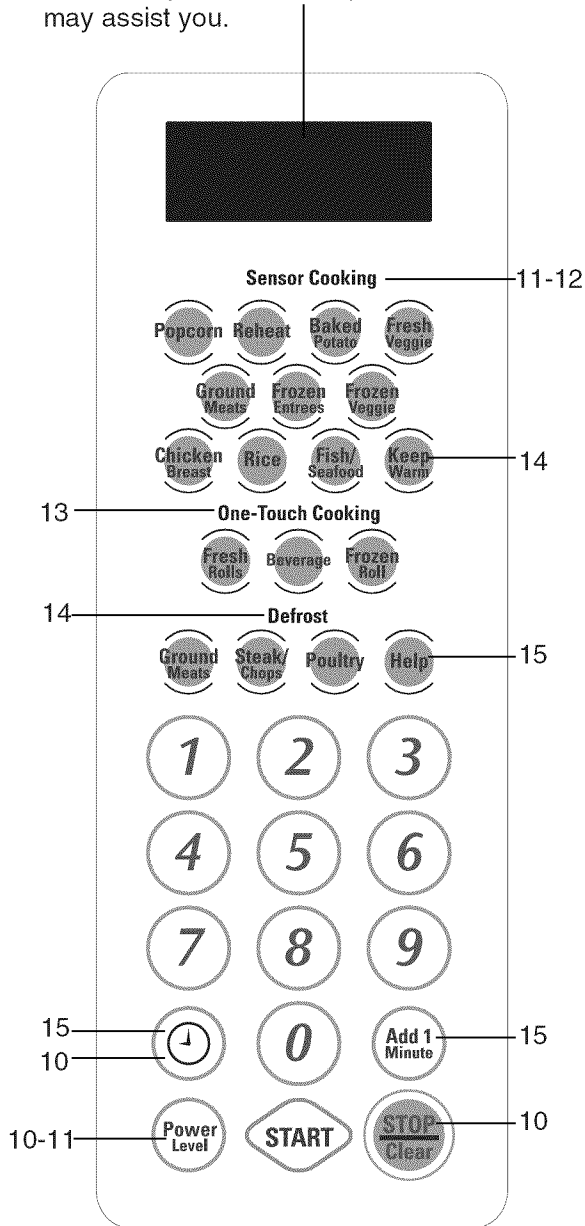

Number next to the control panel illustration indicates page on which there is a feature description and usage information.

## Before Operating the Microwave

- Before operating your new microwave oven make sure you read and understand this Use and Care manual completely.
- Before the microwave oven can be used, follow these procedures:
  1. Plug in the microwave oven. Close the door. The microwave oven display will show *ENJOY YOUR OVEN PRESS CLEAR AND PRESS CLOCK*.
  2. Touch the **Stop/Clear** pad. : will appear.
  3. Set clock.

### TO SET THE CLOCK

- Suppose you want to enter the correct time of day 12:30 (A.M. or P.M.).
  1. Touch pad and number 2.
  2. Enter time 1,2,3,0 and press pad again.

This is a 12 hour clock. If you attempt to enter an incorrect clock time, *ERROR* will appear in the display. Touch the **Stop/Clear** pad and re-enter the time.

• If the electrical power supply to your microwave oven should be interrupted, the display will intermittently show *ENJOY YOUR OVEN PRESS CLEAR AND PRESS CLOCK* after the power is reinstated. If this occurs during cooking, the program will be erased. The time of day will also be erased. Simply touch **Stop/Clear** pad and reset the clock for the correct time of day.

**NOTE:** Your microwave oven can be programmed with the door open except for **START, SENSOR COOKING, ONE-TOUCH COOKING, DEFROST** and **Add 1 Min.**

### STOP/CLEAR

Touch the **Stop/Clear** pad to:

1. Erase if you make a mistake during programming.
2. Cancel timer.
3. Stop the microwave oven temporarily during cooking.
4. Return the time of day to the display.
5. Cancel a program during cooking, touch twice.

## Microwave Manual Operation

### TIME COOKING

Your microwave oven can be programmed for 99 minutes 99 seconds (99.99). Always enter the seconds after the minutes, even if they are both zeros.

- Suppose you want to cook for 5 minutes at 100%.
  1. Enter cooking time 5,0,0.
  2. Touch **START** pad.

### TO SET POWER LEVEL

There are eleven preset power levels.

Using lower power levels increases the cooking time, which is recommended for foods such as cheese, milk and long slow cooking of meats. Consult a cookbook or recipes for specific recommendations.

- Suppose you want to defrost for 5 minutes at 30%.
  1. Enter defrosting time 5,0,0.
  2. Touch **Power Level** pad eight times or hold down until the desired power level appears.
  3. Touch **START** pad.

When the defrost time is complete, a long tone will sound and *END* will appear in the display.

## Microwave Manual Operation (continued)

Touch Power Level Pad Number of Times for Desired Power	Approximate Percentage of Power	Common Words for Power Levels
Power Level x 1	100%	High
Power Level x 2	90%	
Power Level x 3	80%	
Power Level x 4	70%	Medium High
Power Level x 5	60%	
Power Level x 6	50%	Medium
Power Level x 7	40%	
Power Level x 8	30%	Med Low/Defrost
Power Level x 9	20%	
Power Level x 10	10%	Low
Power Level x 11	0%	Standing Time

### MANUAL DEFROST

If the food that you wish to defrost is not listed on the DEFROST TABLE or is above or below the limits in the Amount column on the DEFROST TABLE, you need to defrost manually. You can defrost any frozen food, either raw or previously cooked, by using **Power Level** for 30%. Follow the exact 3-step procedure found under TO SET POWER LEVEL. Estimate defrosting time and press **Power Level** pad eight times for 30%. For either raw or previously cooked frozen food the rule of thumb is approximately 4 minutes per pound. For example, defrost 4 minutes for 1 pound of frozen spaghetti sauce. Always stop the microwave oven periodically to remove or separate the portions that are defrosted. If food is not defrosted at the end of the estimated defrosting time, program the microwave oven in 1 minute increments on **Power Level** 30% until totally defrosted. When using plastic containers from the freezer, defrost only long enough to remove food from the plastic in order to place in a microwave-safe dish.

## Microwave Operating Instructions

### Special Features

#### SENSOR COOKING

The Sensor is a semi-conductor device that detects the vapor (moisture and humidity) emitted from the food as it heats, and then adjusts the cooking times and power level for various foods and quantities.

#### Using Sensor Settings:

- After microwave oven is plugged in, wait 2 minutes before using SENSOR COOKING.
- Be sure the exterior of the cooking container and the interior of the microwave oven are dry. Wipe off any moisture with a dry cloth or paper towel.
- The microwave oven works with foods at normal storage temperature. For example, popcorn would be at room temperature, frozen dinner would be at freezer temperature.
- Any SENSOR COOKING selection can be programmed with More or Less Time Adjustment. See page 16.
- More or less food than the quantity listed in the Sensor Cooking Table should be cooked following the guidelines in any microwave cookbook.
- During the first part of SENSOR COOKING, food selection name will appear on the display. Do not open the microwave oven door or touch **Stop/Clear** during this part of the cooking cycle. The measurement of vapor will be interrupted. If this occurs, an error message will appear. To continue cooking, touch the **Stop/Clear** pad and cook manually. When the sensor detects the vapor emitted from the food, remainder of cooking time will appear. Door may be opened when remaining cooking time appears on the display. At this time, you may stir or season food, as desired.
- If the sensor does not detect vapor properly when popping popcorn, the microwave oven will turn off, and

the correct time of day will be displayed. If the sensor does not detect vapor properly when cooking other foods, *ERROR* will be displayed, and the microwave oven will turn off.

- Check food for temperature after cooking. If additional time is needed, continue to cook manually.
- Each food selection pad has a cooking hint. Touch **Help** pad when the HELP indicator is lighted in the display.

**IMPORTANT OPERATION NOTE:** You must touch a Sensor Cooking pad within 3 minutes of opening and closing the oven door at the beginning of a new cooking cycle. If you do not, the pad will not work until you touch **Stop/Clear**.

#### Covering Foods:

Some foods work best when covered. Use the cover recommended in the SENSOR COOKING TABLE for these foods.

- Casserole lid.
- Plastic wrap: Use plastic wrap recommended for microwave cooking. Cover dish loosely; allow approximately 1/2 inch to remain uncovered to allow steam to escape. Plastic wrap should not touch food.
- Wax paper: Cover dish completely; fold excess wrap under dish to secure. If dish is wider than paper, overlap two pieces at least one inch to cover.

Be careful when removing any covering to allow steam to escape away from you.

#### EXAMPLE:

You can cook many foods by touching just one pad. You don't need to calculate cooking time or power level.

- Suppose you want to reheat chili. Touch **Reheat** pad. When sensor detects the vapor emitted from the food, remainder of reheating time will appear.

# Microwave Operating Instructions (continued)

## Special Features (continued)

### SENSOR COOKING TABLE

FOOD	AMOUNT	PROCEDURE															
Popcorn	1 package 1.5 - 3.5 oz bag	Use only popcorn packaged for microwave oven use. Try several brands to decide which you like. Do not try to pop unpopped kernels. Touch <b>Popcorn</b> pad.															
Reheat	4 - 36 oz	Place food in dish or casserole slightly larger than amount to be reheated. Flatten, if possible. Cover with lid, plastic wrap or wax paper. Use covers such as plastic wrap or lids with larger quantities of more dense foods such as stews. After reheating, stir well, if possible. Re-cover and allow to stand 2 to 3 minutes. Foods should be hot. If not, continue to heat with variable power and time.															
Baked Potato	1 - 8 med.	Pierce. Place on paper-towel-lined turntable. After cooking, remove from microwave oven, wrap in aluminum foil and let stand 5 to 10 minutes.															
Fresh Veggie: Soft Broccoli Brussels sprouts Cabbage Cauliflower (flowerets) Cauliflower (whole) Spinach Zucchini Baked apples	.25 - 2.0 lb .25 - 2.0 lb .25 - 2.0 lb .25 - 2.0 lb 1 med. .25 - 1.0 lb .25 - 2.0 lb 2 - 4 med.	Wash and place in casserole. Add no water if vegetables have just been washed. Cover with lid for tender vegetables. Use plastic wrap for tender-crisp vegetables. Touch <b>Fresh Veggie</b> pad. After cooking, stir, if possible. Let stand, covered, for 2 to 5 minutes.															
Fresh Veggie: Hard Carrots, sliced Corn on the cob Green beans Winter squash: diced halves	.25 - 1.5 lb 2 - 4 .25 - 1.5 lb .25 - 1.5 lb 1 - 2	Place in casserole. Add 1-4 tbsp water. Cover with lid for tender vegetables. Use plastic wrap cover for tender-crisp vegetables. Touch <b>Fresh Veggie</b> pad twice. After cooking, stir, if possible. Let stand, covered, for 2 to 5 minutes.															
Ground Meats	.25 - 2.0 lb	Use this setting to cook ground beef or turkey as patties or in a casserole to be added to other ingredients. Place patties on a microwave-safe rack and cover with wax paper. Place ground meat in a casserole and cover with wax paper or plastic wrap. When microwave oven stops, turn patties over or stir meat in casserole to break up large pieces. Re-cover and touch <b>START</b> . After cooking, let stand, covered, for 2 to 3 minutes.															
Frozen Entrees	6 - 17 oz	Use this pad for frozen convenience foods. It will give satisfactory results for most brands. You may wish to try several and choose your favorite. Remove package from outer wrapping and follow package directions for covering. After cooking, let stand, covered, for 1-3 minutes.															
Frozen Veggie	.25 - 1.5 lb	Add no water. Cover with lid or plastic wrap. After cooking, stir and let stand, covered, for 3 minutes.															
Chicken Breast	.5 - 2.0 lb	Cover with vented plastic wrap. Touch <b>Chicken Breast</b> pad. When microwave oven stops, turn over. Shield with small, flat pieces of aluminum foil any areas that are cooking too rapidly. Re-cover and touch <b>START</b> . After cooking, let stand, covered 3-5 minutes. Chicken should be 160°F.															
Rice	.5 - 2.0 cups	Place rice into a deep casserole and add double quantity of water (see below). Cover with lid or plastic wrap. After cooking, stir, cover and let stand 3 to 5 minutes or until all liquid has been absorbed. <table border="1" style="margin-left: auto; margin-right: auto;"> <thead> <tr> <th>Rice</th> <th>Water</th> <th>Size of casserole</th> </tr> </thead> <tbody> <tr> <td>.5 cup</td> <td>1 cup</td> <td>1.5 quart</td> </tr> <tr> <td>1 cup</td> <td>2 cups</td> <td>2 quart</td> </tr> <tr> <td>1.5 cups</td> <td>3 cups</td> <td>2.5 or 3 quart</td> </tr> <tr> <td>2 cups</td> <td>4 cups</td> <td>3 quart or larger</td> </tr> </tbody> </table>	Rice	Water	Size of casserole	.5 cup	1 cup	1.5 quart	1 cup	2 cups	2 quart	1.5 cups	3 cups	2.5 or 3 quart	2 cups	4 cups	3 quart or larger
Rice	Water	Size of casserole															
.5 cup	1 cup	1.5 quart															
1 cup	2 cups	2 quart															
1.5 cups	3 cups	2.5 or 3 quart															
2 cups	4 cups	3 quart or larger															
Fish/Seafood	.25 - 2.0 lb	Arrange in ring around shallow glass dish (roll fillet with edges underneath). Cover with vented plastic wrap. After cooking, let stand, covered for 3 minutes.															



# Microwave Operating Instructions (continued)

## Special Features (continued)

### ONE-TOUCH COOKING

ONE-TOUCH COOKING allows you to cook or reheat many of your favorite foods by touching just one pad.

- Suppose you want to heat 2 fresh rolls or muffins.

Touch **Fresh Rolls** pad 2 times. The microwave oven starts automatically.

#### NOTE:

1. To increase quantity, touch chosen pad until number in display is same as desired quantity to cook. Ex: touch **Beverage** two times for one cup. More or less food than the quantity listed in the table should be heated following the guidelines in any microwave cookbook.

2. ONE-TOUCH COOKING can be programmed with More or Less Time Adjustment. See page 16.

3. The final result will vary according to the food condition (e.g. initial temperature, shape, quality). Check food for temperature after heating. If additional time is needed, continue to heat manually.

**IMPORTANT OPERATION NOTE:** You must touch a One-Touch Cooking pad within 3 minutes of opening and closing the oven door at the beginning of a new cooking cycle. If you do not, the pad will not work until you touch **Stop/Clear**.

### ONE-TOUCH COOKING TABLE

FOOD	AMOUNT	PROCEDURE
Fresh Rolls	1 - 10 pieces	Use this pad to warm rolls, muffins, biscuits, bagels etc. Large items should be considered as 2 or 3 of regular size. Arrange on plate; cover with paper towel. For refrigerated rolls or muffins, it may be necessary to double the entered amount to ensure the proper serving temperature. For example, enter quantity of 2 for 1 refrigerated muffin.
Beverage	.5 - 2.0 cups	This setting is good for restoring cooled beverage to a better drinking temperature. Stir liquid briskly before heating to avoid "eruption". Touch <b>Beverage</b> pad. <b>Press the pad for amount</b> Once .5 cup Twice 1 cup 3 times 1.5 cups 4 times 2 cups
Frozen Rolls	1 - 10 pieces	Use this pad to warm rolls, muffins, biscuits, bagels etc. Large items should be considered as 2 or 3 of regular size. Arrange on plate; cover with paper towel.

ENGLISH



# Microwave Operating Instructions (continued)

## Special Features (continued)

### DEFROST

DEFROST automatically defrosts all the foods shown in the DEFROST TABLE.

Round the weight to the nearest half pound. (Ex: if the steak's actual weight is 2.2 lb round to 2.0 lb If the steak's weight is 2.4 lb round to 2.5 lb.)

To enter weight, touch the desired DEFROST pad for a 0.5 lb increase per touch. (Ex: touch four times for 2.0 lb.)

You must enter the weight within 1 second of touching the Defrost pad, or the oven will begin defrosting. To return to adjust the weight, **you must touch Stop/Clear twice.**

• Suppose you want to defrost a 2.0 pound steak.

1. Quickly touch **Steak/Chops** pad 4 times for 2.0 lb. The microwave oven will start automatically.

The microwave oven will stop and directions will be displayed. Follow the indicated message.

2. After the 1st stage, open the door, turn steak over and shield any warm portions with aluminum foil. Close the door. Touch **START** pad.

3. After the 2nd stage, open the door and shield any warm portions. Close the door. Touch **START** pad.

After defrost cycle ends, cover and let stand as indicated in table.

### DEFROST TABLE

FOOD	AMOUNT	PROCEDURE
Ground Meats	.5 - 2.0 lb	Remove any thawed pieces after each stage. Let stand, covered, for 5 to 10 minutes.
Steaks/Chops	.5 - 3.0 lb	After each stage, rearrange and if there are warm or thawed portions, shield with small flat pieces of aluminum foil. Remove any meat or fish that is nearly defrosted. Let stand, covered, for 10 to 20 minutes.
Poultry (Pieces)	.5 - 3.0 lb	After each stage, if there are warm or thawed portions, rearrange or remove. Let stand, covered, for 10 to 20 minutes.

### KEEP WARM

Keep Warm allows you to keep food warm up to 30 minutes.

#### DIRECT USE

• Suppose you want to keep a cup of soup warm for 15 minutes.

1. Touch **Keep Warm** pad.

2. Enter time 1,5,0,0.

3. Touch **START** pad.

The microwave oven will start. The display will show *15.00* and count down. **KEEP WARM** will be displayed during the count down.

You can program Keep Warm with manual cooking to keep food warm continuously after cooking.

### NOTE:

1. If you attempt to enter more or less than the allowed weight as indicated in table, **ERROR** will appear in the display.

2. DEFROST can be programmed with More or Less Time Adjustment. See page 16.

3. To defrost other foods or foods above or below the weights allowed on DEFROST TABLE use time and 30% power. See Manual Defrost on page 11.

4. You may choose to enter the weight in tenths of a pound. This procedure may be easier with larger weights, such as 3 pounds, because it requires fewer touches. To program, touch desired DEFROST pad and enter weight by touching the number pads. Ex: touch **Steaks/Chops** then 3 and 0 for a weight of three pounds or touch **Steaks/Chops** then 2 and 2 for a weight of 2.2 lb.

**IMPORTANT OPERATION NOTE:** You must touch a Defrost pad within 3 minutes of opening and closing the oven door at the beginning of a new cooking cycle. If you do not, the pad will not work until you touch **Stop/Clear**.

### WITH MANUAL COOKING

• Suppose you want to cook a cup of soup for 2 minutes at 70% and keep the soup warm for 15 minutes.

1. Enter cooking time 2,0,0.

2. Touch **Power Level** pad 4 times for 70% power.

3. Touch **Keep Warm** pad.

4. Enter time 1,5,0,0.

5. Touch **START** pad.

The operation will start. When the cooking time is complete, a long tone will sound and **Keep Warm** will start. The display will count down for 15 minutes and **KEEP WARM** will be displayed during the count down.

**NOTE:** Keep Warm cannot be programmed with SPECIAL FEATURES.

# Microwave Operating Instructions (continued)

## Other Convenient Features

### HELP

Help provides 4 features that make using your microwave oven easy because specific instructions are provided in the interactive display.

#### 1. Child Lock

The Child Lock prevents unwanted microwave oven operation such as by small children. The microwave oven can be set so that the control panel is deactivated or locked. To set, touch **Help**, the number 1 and then touch the **START** pad. Should a pad be touched, *CHILD LOCK ON* will appear in the display. To cancel, touch **Help** and **Stop/Clear** pad.

#### 2. Audible Signal Elimination

If you wish to have the microwave oven operate with no audible signals, touch **Help**, the number 2 and **Stop/Clear**. To cancel and restore the audible signal, touch **Help**, the number 2 and **START**.



#### 3. Auto Start

If you wish to program your microwave oven to begin cooking automatically at a designated time of day, follow this procedure:

- Suppose you want to start cooking a stew for 20 minutes on 50% at 4:30. Before setting, check to make sure the clock is showing the correct time of day.

1. Touch **Help** pad.
2. Touch number 3.
3. Enter number 4,3,0 for start time.
4. Touch  pad.
5. Enter cooking program by touching number 2,0,0,0, **Power Level** pad 6 times.
6. Touch **START** pad; auto start time appears in the display.

#### NOTE:

1. Auto Start can be used for manual cooking if clock is set.
2. If the microwave oven door is opened after programming Auto Start, it is necessary to touch the **START** pad for Auto Start time to appear in the readout so that the microwave oven will automatically begin programmed cooking at the chosen Auto Start time.
3. Be sure to choose foods that can be left in the microwave oven safely until the Auto Start time. Acorn or butternut squash are often a good choice. Do not use foods that can easily spoil.
4. If you wish to know the time of day, simply touch the  pad. As long as your finger is touching the  pad, the time of day will be displayed.

#### 4. Language/Weight Selection

The microwave oven comes set for English and U.S. Customary Unit-pounds. To change, touch **Help** and the number 4. Continue to touch the number 4 until your choice is selected from the table below. Then, touch **START**.

- Touch number 4 once for English/LB.
- Touch number 4 twice for English/KG.
- Touch number 4 three times for Spanish/LB.
- Touch number 4 four times for Spanish/KG.
- Touch number 4 five times for French/LB.
- Touch number 4 six times for French/KG.

#### HELP (In display)

Whenever HELP is lighted in the Interactive Display, touch **Help** to read cooking and operating hints.

#### MULTIPLE STAGE COOKING

Your microwave oven can be programmed for sequence of up to 4 cooking stages, switching from one power level setting to another automatically.

Sometimes cooking directions tell you to start on one power level and then change to a different power level. Your microwave oven can do this automatically.

- Suppose you want to cook roast beef for 5 minutes at 100%, continue to cook for 30 minutes at 50% and finish with 5 minutes of standing time in oven.
  1. First enter cooking time. Then touch **Power Level** pad once for 100% power.
  2. Enter second cooking time. Touch **Power Level** pad 6 times for 50% power.
  3. Enter the standing time. Touch **Power level** pad 11 times.
  4. Touch **START** pad.

#### NOTE:

1. If you wish to know power level, simply touch the **Power Level** pad. As long as your finger is touching the **Power Level** pad, the power level will be displayed.
2. If 100% is selected as the final sequence, it is not necessary to touch the **Power Level** pad.

# Microwave Operating Instructions (continued)

## Other Convenient Features

### ADD 1 MIN

Add 1 Min allows you to cook for a minute at 100% by simply touching the **Add 1 Min** pad. You can also extend cooking time in multiples of 1 minute by repeatedly touching the **Add 1 Min** pad during manual cooking.

#### NOTE:

1. To use **Add 1 Min**, touch pad within 3 minutes after cooking, closing the door, touching the **Stop/Clear** pad or during cooking.
2. **Add 1 Min** cannot be used with Special Features.

### DEMONSTRATION MODE

To demonstrate, touch , the number 0 and touch **START** and hold for 3 seconds. *DEMO ON* will appear in the display. Cooking operations and specific special features can now be demonstrated with no power in the microwave oven. For example, touch **Stop/Clear** and touch **Add 1 Min**, and the display will show *1.00* and count down quickly to *END*.

To cancel, touch , then the number 0 and **Stop/Clear**. If easier, unplug the microwave oven from the electrical outlet, replug and set the clock.



### MORE OR LESS DONE ADJUSTMENT

You may discover that you like the results of one of the cooking functions (Sensor Cooking, One-Touch Cooking, or Defrost) slightly **more** or **less** done.

- For more done, touch the Power Level pad once within 1 second after selecting a cooking function. **MORE** will appear in the display.
- For less done, touch the Power Level pad twice within 1 second after selecting a cooking function. **LESS** will appear in the display.

If you fail to touch the Power Level pad within 1 second after selecting a cooking function, the oven will start the function. To return to adjust function to more or less **you must touch Stop/Clear twice**.

### TIMER

- Suppose you want to time a 3 minute long distance phone call.
  1. Touch  pad and number 1.
  2. Touch 3,0,0 to enter time.
  3. Touch  pad. The Timer will count down.

# Wall Oven Vent and Racks

Oven Vent Location

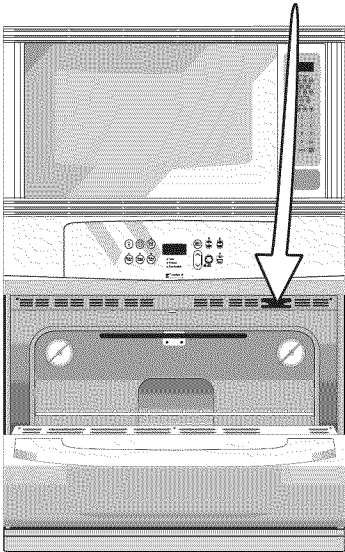

**CAUTION** Some models are equipped with a blower which runs in baking and self-cleaning mode to keep all internal components at a cool temperature. The blower may keep running even if the oven has been turned off, until the components have cooled down.

## Oven Vent Location

The oven is vented **at the center trim**. When the oven is on, warm air is released through the vent. This venting is necessary for proper air circulation in the oven and good baking results.

## Arranging Oven Racks

*ALWAYS ARRANGE OVEN RACKS WHEN THE OVEN IS COOL (PRIOR TO OPERATING THE OVEN).* Always use oven mitts when using the oven.

**To remove an oven rack**, pull the rack forward until it stops. Lift up front of rack and slide out.

**To replace an oven rack**, fit the rack onto the guides on the oven walls. Tilt the front of the rack upward and slide the rack back into place.

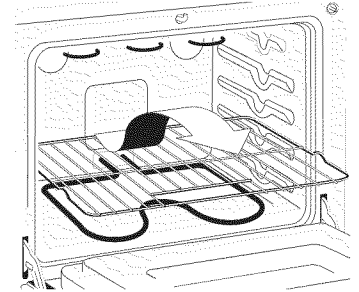

## Air Circulation in the Oven

If using 1 rack, place in center of oven. If using multiple racks, stagger cookware as shown.

For best air circulation and baking results allow 2-4" (5-10 cm) around the cookware for proper air circulation and be sure pans and cookware do not touch each other, the oven door, sides or back of the oven cavity. The hot air must circulate around the pans and cookware in the oven for even heat to reach around the food.

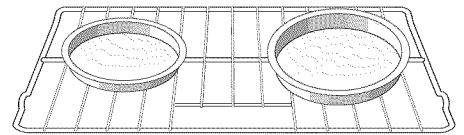

1 Oven Rack

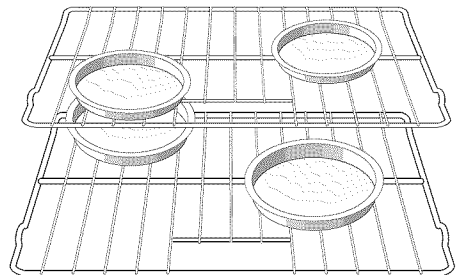

Multiple Oven Racks

ENGLISH

# Wall Oven Control Pad Features

**Note:** The appearance of your oven control may differ slightly from the one illustrated below. However, all functions are the same. Also, push buttons or pads may be shaped differently than those appearing in this Use and Care Guide.

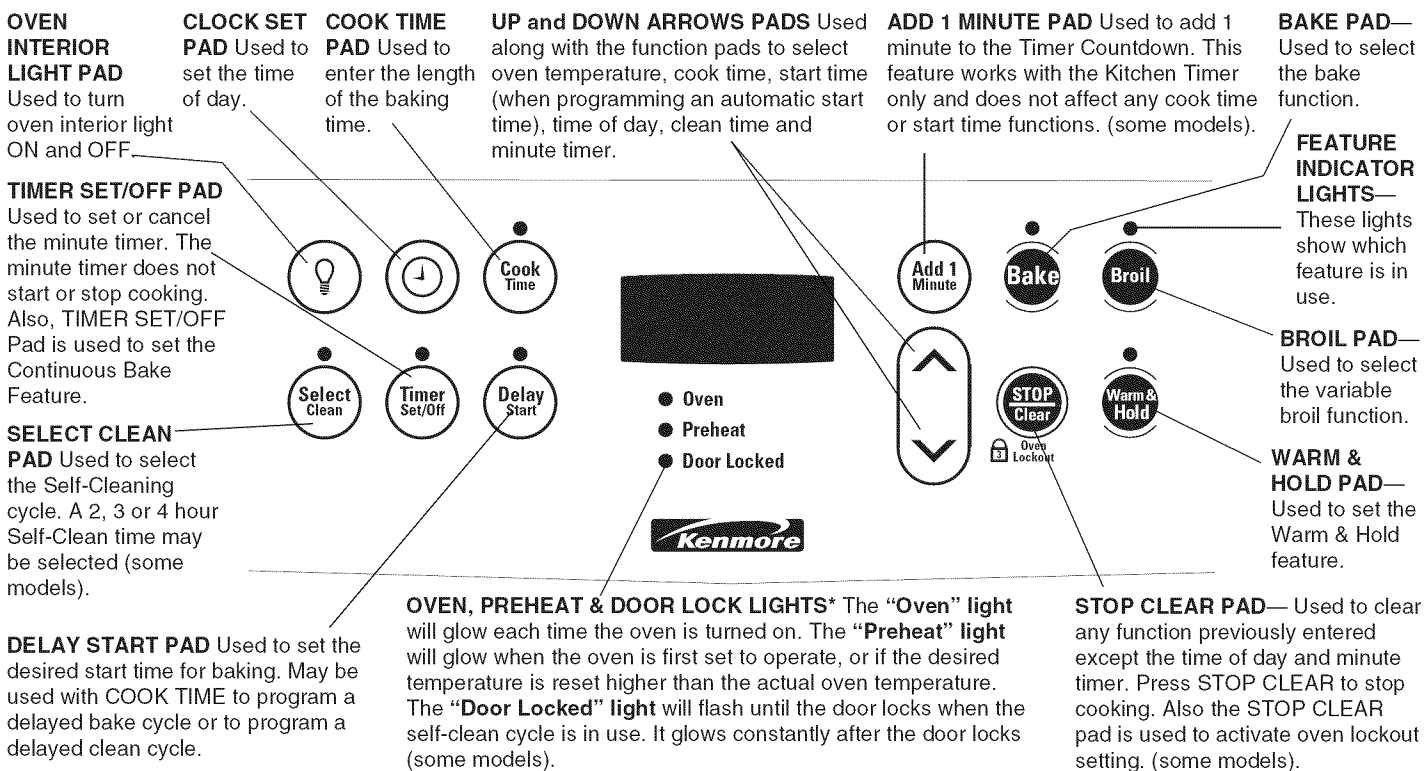

**READ THE INSTRUCTIONS CAREFULLY BEFORE USING THE OVEN.** For satisfactory use of your oven, become familiar with the various functions of the oven as described below.



**\*Note:** The **OVEN** indicator light on the electronic display will turn ON and OFF when using the Bake feature and during preheat. This is normal and indicates that the oven is cycling to maintain the selected baking temperature. When preheat indicator light turns OFF, your oven is ready.

## For a silent control panel:

When choosing a function, a beep will be heard each time a pad is pressed. If desired, the control can be programmed for silent operation.





- To tell if your oven is set for normal or silent operation press and hold  for 7 seconds. "- -" or "SP" (speaker) appears in the display.
- Within 5 seconds, press the  or  pad to switch between normal sound operation and silent operation mode. The display will show either "- -" or "SP".
- Wait 5 seconds to return to normal operating mode.

If "SP" appears, the control will operate with normal sounds and beeps. If "- -" appears, the control is in the silent operation mode.

## Temperature Conversion (Fahrenheit / Celsius)

The electronic oven control is set to operate in °F (Fahrenheit) when shipped from the factory. The oven can be programmed for any temperature from 170°F to 550°F (77°C to 288°C).

**To change the temperature to °C (Celsius) or from °C to °F (control should not be in a Bake or Clean mode):**

- Press and hold  for 7 seconds until °F or °C appears in the display.
- Press the  or  pad to change °F to °C or °C to °F.
- Wait 5 seconds to accept the changes or press  to accept the changes.







# Setting the Wall Oven Clock

**Note:** The time of day **must** first be set in order to operate the oven.

## To Set the Clock





When the range is first plugged in, or when the power supply to the appliance has been interrupted, the display will flash "12:00".

1. Press  once (do not hold pad down).
2. Within 5 seconds, press and hold the  or  until the correct time of day appears in the display.
3. Press  once to accept the new time of day. If  is not pressed, the timer will return automatically to the new time of day after 7 seconds.

**Note:** The clock cannot be changed during any timed bake, delayed time bake, self-clean cycle or delayed self-clean cycle.





---

## Changing Between 12 or 24 Hour Time of Day Display

1. Press and hold  for 7 seconds. After 7 seconds, "12Hr" or "24Hr" will appear in the display and the control will beep once.
2. Press  or  to switch between the 12 and 24 hour time of day display. The display will show either "12Hr" or "24Hr".
3. Wait 5 seconds or press  to return to the time of day display.
4. Reset the correct time as described in **To set the Clock** above. Please note that if the 24 hour time of day mode was chosen, the clock will now display time from 0:00 through 23:59 hours.

---

## To Set the Minute Timer

1. Press .
2. Press the  to increase or  to decrease the time in one minute increments. The timer can be set for any amount of time from 1 minute to 11 hours and 59 minutes.
3. The display shows the timer countdown in minutes if more than 1 hour remains. When less than 1 hour remains, the display will count down in seconds.
4. When the set time has run out, the timer will beep 3 times. It will continue to beep 3 times every 8 seconds until  is pressed.



**Note:** The indicator light located above the  pad will glow while the minute timer is active.

**Note:** The minute timer does not start or stop cooking. It serves as an extra timer in the kitchen that will beep when the set time has run out. The minute timer can be used alone or during any of the other oven functions. When the minute timer is in use with any other function, the minute timer will be shown in the display. To view other functions, press the function pad for that function.

**To Cancel the Minute Timer before the set time has run out:** Press .

---

## To Set Add 1 Minute Feature

The  ADD 1 MINUTE pad is used to set the Add 1 Minute feature. When the  pad is pressed, 1 minute is added to the Minute Timer feature if this feature is already active. If the Minute Timer feature is not active and the

 pad is pressed, the Minute Timer feature will become active and will begin counting down from 1 minute. For further information on how to set the Minute Timer feature see To Set the Minute Timer instructions above.

## Setting Wall Oven Controls

**Note:** The time of day **must** first be set in order to operate the oven.

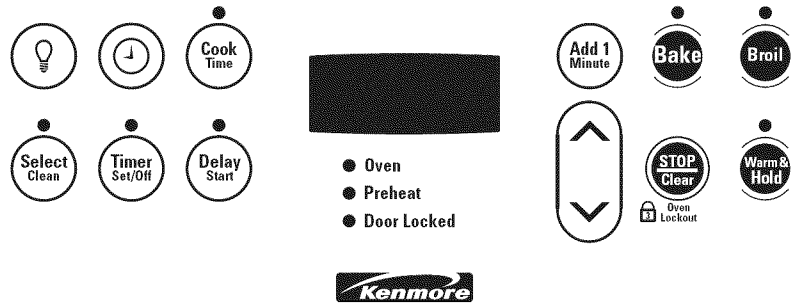

### To Set or Change the Temperature for Baking

The oven can be programmed to bake at any temperature from 170°F to 550°F (77°C to 288°C).

#### To Set the Controls for Normal Baking:

1. Press **Bake**. "— — —°" appears in the display.
2. Within 5 seconds, press the **▲** or **▼**. The display will show "350°F (177°C)." By pressing and holding **▲** or **▼**, the temperature can then be adjusted in 5°F increments (1°C if the control is set to display Celsius).
3. 10 seconds after the **▲** or **▼** pad is released, the oven will begin heating to the selected temperature. When the displayed temperature reaches the desired baking temperature, the preheat indicator light will turn OFF.
4. To cancel the baking function, press **STOP Clear**.

#### To Change the Oven Temperature after Baking has Started:

Press the **▲** or **▼** pad to increase or decrease the set temperature.

### To Set Control for Continuous Bake or 12 Hour Energy Saving:

The oven control has a built-in 12 Hour Energy Saving feature that will shut off the oven if the control is left on for more than 11 hours and 59 minutes. The oven can be programmed to override this feature for continuous baking.

#### To set control for continuous baking:

1. Press and hold **Timer Set/Off** down for 7 seconds until tone is heard.
2. Within 5 seconds, press the **▲** or **▼** pad to switch between Continuous Bake and 12 Hour Energy Saving mode. The display will show either "- - hr" or "12hr".  
If "- - hr" appears, the oven will be set to continuous baking. If "12hr" appears, the oven is set to 12 hour energy saving mode.
3. Wait 5 seconds or press **STOP Clear** to return to normal operating mode.

### To Set Control for Oven Lockout:



The control can be programmed to lock the oven door and lock the oven control pads.

#### To Set Control for Oven Lockout feature:

1. Press **STOP Clear** and hold for 3 seconds. The "Door Locked" indicator light will glow and the motor driven door lock will begin to close automatically. **DO NOT open oven door** while the indicator light is flashing. Allow about 15 seconds for the oven door to lock. Once the oven door is locked, "Loc" will appear in display.
2. To cancel the Oven Lockout feature, press **STOP Clear** and hold for 3 seconds. The control will unlock the oven door and resume normal operation.









# Setting Wall Oven Controls

## To Set the Timed Bake and Delay Start Features



The  **COOK TIME** and  **DELAY START** pads operate the features that will turn the oven ON and OFF at the times you select in advance. The oven can be programmed to start immediately and shut off automatically (Timed Bake) or to begin baking at a later time with a delayed start time (Delay Start).

**Note:** During Timed Bake the preheat indicator light will glow during the preheat operation.











### To Program the Oven to Begin Baking Immediately and To Shut Off Automatically (Timed Bake):

1. Be sure that the clock shows the correct time of day.
2. Place the food in the oven.
3. Press . "— — —°" appears in the display.
4. Within 5 seconds, press the  or . The display will show "350°F (177°C)." By holding the  or , the temperature can then be adjusted in 5°F increments (1° if the control is set to display Celsius).
5. Wait 8 seconds to accept the temperature.
6. Press . "0:00" will flash in the display (MIN:SEC) or (HR:MIN) if programmed for more than 60 minutes.
7. Press the  or  pad until the desired baking time appears in the display.
8. The oven will turn ON and begin heating.



**Note:** When the control is set for this function the oven temperature will be displayed. To see the cook time remaining

press  and to see the time of day press .

### To Program Oven for a Delayed Start Time and to Shut-Off Automatically (Delayed Start Bake):

1. Be sure that the clock shows the correct time of day.
2. Place the food in the oven.
3. Press . "— — —°" appears in the display.
4. Within 5 seconds, press the  or . The display will show "350°F (177°C)." By holding the  or , the temperature can then be adjusted in 5°F increments (1° if the control is set to display Celsius).
5. Wait 8 seconds to accept the temperature.
6. Press . "0:00" will flash in the display (MIN:SEC) and (HR:MIN) if programmed for more than 60 minutes.
7. Press the  or  until the desired baking time appears.
8. Wait 5 seconds for control to accept the time.
9. Press . The earliest possible start time will appear in the display.
10. Press the  or  until the desired start time appears in the display and wait 7 seconds to accept.
11. Once the controls are set, the control calculates the time when baking will start and stop.
12. The oven will turn ON at the delayed start time and begin heating.



**Note:** When the control is set for a delayed time bake the time of day is displayed until the delayed time bake is reached. When the oven will turn on, the oven temperature will be displayed. To see the cook time remaining

press  and to see the time of day press .

### When the Set Bake Time Runs Out:

1. "END" will appear in the display window and the oven will shut off automatically.
2. The control will beep 3 times every 25 seconds until  is pressed.

### To Change the Oven Temperature or Bake Time after Baking has Started:

1. Press the function pad you want to change.
2. Press the  or  to adjust the setting.

**CAUTION** Use caution with the Timed Bake and Delayed Start features. Foods that can easily spoil such as milk, eggs, fish, meat or poultry, should be chilled in the refrigerator first. Even when chilled, they should not stand in the oven for more than 1 hour before cooking begins, and should be removed promptly when cooking is completed.

# Setting Wall Oven Controls

## Oven Baking

For best cooking results, heat the oven before baking cookies, breads, cakes, pies or pastries, etc... There is no need to preheat the oven for roasting meat or baking casseroles.

The cooking times and temperatures needed to bake a product may vary slightly from your previously owned appliance.

**Baking Problems and Solutions Table**

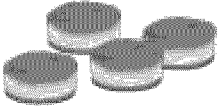
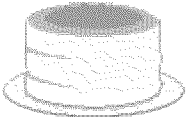
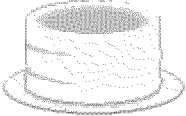
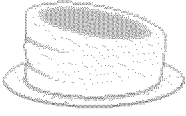
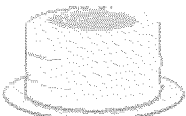
Baking Problems	Causes	Corrections
<p><b>Cookies and biscuits burn on the bottom.</b></p> 	<ul style="list-style-type: none"> <li>• Cookies and biscuits put into the oven before the preheating time is completed.</li> <li>• Oven rack overcrowded.</li> <li>• Dark pan absorbs heat too fast.</li> </ul>	<ul style="list-style-type: none"> <li>• Allow oven to preheat to the selected temperature before placing food in oven.</li> <li>• Choose pan sizes that will permit 5.1 cm to 10.2 cm (2" to 4") of air space on all sides when placed in the oven.</li> <li>• Use a medium-weight aluminum baking sheet.</li> </ul>
<p><b>Cakes too dark on top or bottom.</b></p> 	<ul style="list-style-type: none"> <li>• Cakes put into the oven before preheating time is completed.</li> <li>• Rack position too high or low.</li> <li>• Oven too hot.</li> </ul>	<ul style="list-style-type: none"> <li>• Allow oven to preheat to the selected temperature before placing food in the oven.</li> <li>• Use proper rack position for baking needs.</li> <li>• Set oven temperature 25°F/12°C lower than recommended.</li> </ul>
<p><b>Cakes not done in the center.</b></p> 	<ul style="list-style-type: none"> <li>• Oven too hot.</li> <li>• Incorrect pan size.</li> <li>• Pan not centered in oven.</li> </ul>	<ul style="list-style-type: none"> <li>• Set oven temperature 25°F/12°C lower than recommended.</li> <li>• Use pan size suggested in recipe.</li> <li>• Use proper rack position and place pan so there is 5.1 cm to 10.2 cm (2" to 4") of space on all sides of pan.</li> </ul>
<p><b>Cakes not level.</b></p> 	<ul style="list-style-type: none"> <li>• Range not level.</li> <li>• Pan too close to oven wall or rack overcrowded.</li> <li>• Pan warped.</li> </ul>	<ul style="list-style-type: none"> <li>• Place a marked glass measuring cup filled with water on the center of the oven rack. If the water level is uneven, refer to the installation instructions for leveling the range.</li> <li>• Be sure to allow 5.1 cm to 10.2 cm (2" to 4") of clearance on all sides of each pan in the oven.</li> <li>• Do not use pans that are dented or warped.</li> </ul>
<p><b>Foods not done when cooking time is up.</b></p> 	<ul style="list-style-type: none"> <li>• Oven too cool.</li> <li>• Oven overcrowded.</li> <li>• Oven door opened too frequently.</li> </ul>	<ul style="list-style-type: none"> <li>• Set oven temperature 25°F/12°C higher than suggested and bake for the recommended time.</li> <li>• Be sure to remove all pans from the oven except the ones to be used for baking.</li> <li>• Open oven door only after shortest recommended baking time.</li> </ul>

# Setting Wall Oven Controls

## Broil

Broiling is a method of cooking tender cuts of meat by direct heat under the broil element of the oven. Be sure you center the broiler pan directly under the broil element for best results.

Arrange oven rack while oven is still cool. Position the rack as needed.

Broiler pan and its insert allow dripping grease to drain and be kept away from the high heat of the broiler. **DO NOT** use a pan without its insert. **DO NOT cover the insert with foil.** The exposed grease could ignite.

**⚠ WARNING** Should an oven fire occur, close the oven door and turn off the oven. If the fire continues, throw baking soda on the fire or use a fire extinguisher. **DO NOT** put water or flour on the fire. Flour may be explosive and water can cause a grease fire to spread and cause personal injury.

### To set for broiling:

1. Arrange oven rack while oven is still cool.
2. Press **Broil**. "- -" will appear in the display.
3. Press the **▲** or **▼** pad until the desired broil setting level appears in the display. Press the **▲** pad for **HI** broil or the **▼** pad for **LO** broil. Most foods may be broiled at the **HI** broil setting. Select the **LO** broil setting to avoid excess browning or drying of foods that should be cooked to the well-done stage.
4. Place the insert on the broiler pan, then place the food on the insert. **DO NOT** use the pan without the insert or cover the insert with **aluminum foil**. The exposed grease could ignite.
5. Place the pan on the oven rack. **Open the oven door to the broil stop position when broiling.**
6. Broil on one side until food is browned. Turn and broil food on 2nd side. **Note:** Always pull the rack out to the stop position before turning or removing food.
7. When broiling is finished, press **STOP Clear**.

### To Operate the Oven Light(s)

The interior oven light(s) will automatically turn ON when the oven door is opened.

Press **Light** to turn the interior light(s) ON and OFF whenever the door is closed.

The interior oven light(s) is (are) located at the upper left (and right, some models) rear wall of the oven interior and is covered with a glass shield held by a wire holder. The glass shield must be in place whenever the oven is in use. To change the interior oven light(s), see changing the Oven Light in the **General Care & Cleaning** section.

Grid  
(some models)

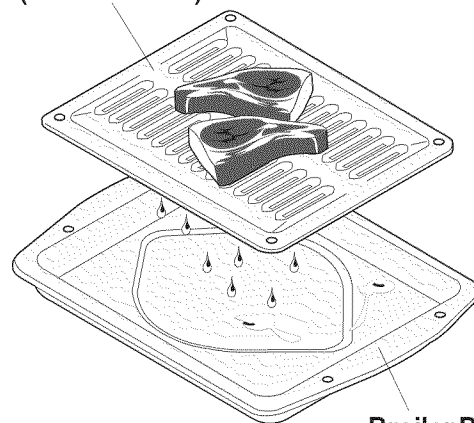

Broiler Pan  
(some models)

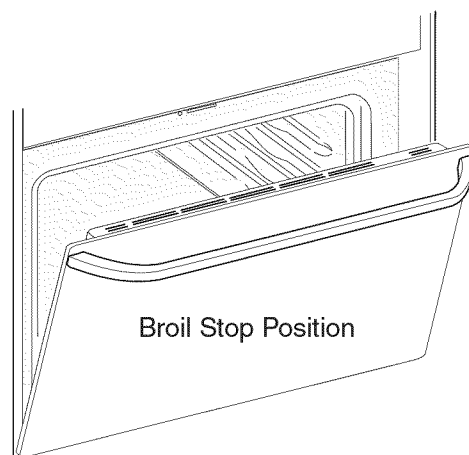

Broil Stop Position

ENGLISH

# Setting Wall Oven Controls

## Preheating

Preheating the oven is suggested when searing rare steaks. (Remove all utensils from the oven before preheating. Foods will stick if placed on hot metal.) To preheat, set the control(s) to BROIL as instructed in the Owner's Guide. Wait for the element to become red-hot, usually about 2 minutes. Preheating is not necessary when broiling meats well-done.

## To Broil

Broil one side until the food is browned; turn and cook on the second side. Season and serve. Always pull rack out to the "stop" position before turning or removing food.

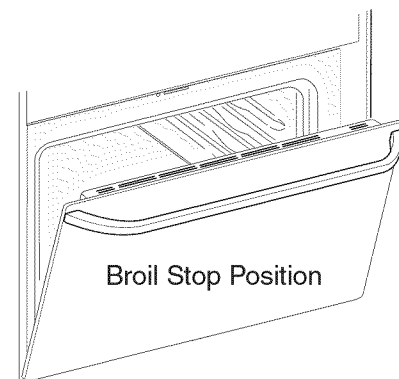

## Determine Broiling Times

Broiling times vary, so watch the food closely. Time not only depends on the distance from element, but on the thickness and aging of meat, fat content and doneness preferred. The first side usually requires a few minutes longer than second. Frozen meats also require additional time.

## Broiling Tips (some models)

The broiler pan and its grid allow dripping grease to drain and be kept away from the high heat of the broiler.

**DO NOT use the pan without its grid. DO NOT cover the grid with foil. The exposed grease could ignite.**

**CAUTION** Should an oven fire occur, close the oven door and turn off the oven. If the fire continues, throw baking soda on the fire or use fire extinguisher. DO NOT put water or flour on the fire. Flour may be explosive.

## Broiler Clean-Up Tips (some models)

To make cleaning easier, line the bottom of the broiler pan with aluminum foil. DO NOT cover the broiler grid with foil.

To prevent grease from baking on, remove the broiler pan from the oven as soon as cooking is completed. Use hot pads because the broiler pan is extremely hot.

Pour off grease. Soak the pan in HOT, soapy water.

Clean the broiler pan as soon as possible after each use. If necessary, use soap-filled steel wool pads. Heavy scouring may scratch the grid.

Grid (some model)

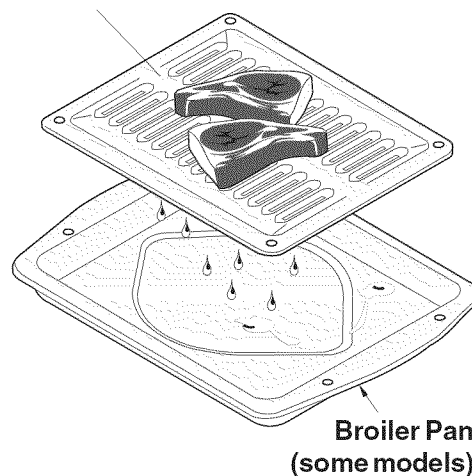





# Setting Wall Oven Controls





## Setting the Warm & Hold™ Feature

The  pad turns ON the Serve Warm & Hold feature and will maintain an oven temperature of 170° F (77°C). The **Warm & Hold** feature will keep oven baked foods warm for serving up to 3 hours after cooking has finished. After 3 hours the Warm & Hold feature will shut the oven OFF automatically. The Warm & Hold feature may be used without any other cooking operations or can be used after cooking has finished using **TIMED BAKE** or **DELAY TIMED BAKE**.

### To set Warm & Hold:



1. Arrange interior oven racks and place baked food in oven. If the food is already in the oven go to step 2.
2. Press . "-" "-" will appear in the display and the Warm & Hold indicator light above the pad will turn ON.  
Note: If no further pads are touched within 6 seconds the request to turn ON Warm & Hold will be cleared.
3. Press  or  to start.
4. To turn Warm & Hold OFF at any time press . The Warm & Hold indicator light above the pad will turn OFF.

### To set Warm & Hold to turn ON automatically:





1. Arrange interior oven racks and place food in oven. Set the oven properly for **Timed Bake** or **Delay Timed Bake**.
2. Press . "-" "-" will appear in the display and the Warm & Hold indicator light above the pad will turn ON.
3. Press  or  to start. Warm & Hold is set to turn ON automatically after Timed Bake or Delayed Start Bake has finished.
4. To turn Warm & Hold OFF at any time press . The Warm & Hold indicator light above the pad will turn OFF.

# Setting Wall Oven Controls













## To Set the Sabbath Feature (for use on the Jewish Sabbath & Holidays)

The  **COOK TIME** and  **DELAY START** pads are used to set the Sabbath feature. The Sabbath feature may only be used with the  pad. The oven temperature may be set higher or lower after setting the Sabbath feature (the oven temperature adjustment feature should be used only during Jewish Holidays), however the display will not visibly show or provide any audible tones indicating whether the change occurred correctly. Once the oven is properly set using Bake with the Sabbath feature active, the oven will remain continuously ON until cancelled. This will override the factory preset 12-Hour Energy Saving feature.



If the oven light will be needed during the Sabbath, press  before activating the Sabbath feature. Once the oven light is turned ON and the Sabbath feature is active, the oven light will remain ON until the Sabbath feature is turned OFF. If the oven light needs to be OFF, be sure to turn the oven light OFF before activating the Sabbath feature.

**IMPORTANT NOTES:** It is not advised to attempt to activate any other program feature other than **BAKE** while the Sabbath feature is active. ONLY the following key pads will function after setting the Sabbath feature; , ,  & . **ALL OTHER KEYPADS** will not function once the Sabbath feature is properly activated.

### To Program the Oven to Begin Baking Immediately & activate the Sabbath feature:

1. Be sure that the clock is set with the correct time of day.
2. Place the food in the oven.
3. Press . " — — — ° " appears in the display.
4. Within 5 seconds, press the  or . The display will show "350°F (177°C)." By holding the  or , the temperature can then be adjusted in 5°F increments (1°C if the control is set to display Celsius).
5. If you desire to set the oven control for a **Timed Bake** or **Delayed Start Bake** do so at this time. If not, skip this step and continue to step 6. Refer to the **Timed Bake** (complete steps 6-7) / **Delayed Start Bake** (complete steps 6-10) section for complete instructions. Remember the oven will shut down after using **Timed Bake** or **Delay Start Bake** and therefore may only be used once during the Sabbath/Jewish Holidays. The maximum **Delayed Start Bake** time is 11 hours & 59 minutes.
6. The oven will turn ON and begin heating.
7. Press and hold both the  and  pads for at least 3 seconds. **SAb** will appear in the display. Once **SAb** appears in the display the oven control will no longer beep or display any further changes and the oven is properly set for the Sabbath feature.  
**Note:** You may change the oven temperature once baking has started by pressing the  or  (for Jewish Holidays only). The oven temperature will be adjusted in 5°F increments with each press of these pads (1°C if the control is set to display Celsius). Remember that **the oven control will no longer beep or display any further changes** once the oven is set for the Sabbath feature.
8. The oven may be turned OFF at any time by first pressing  pad (this will turn the oven OFF only). To turn OFF the Sabbath feature press and hold both the  and  pads for at least 3 seconds. **SAb** will disappear from the display.

Should you experience a power failure or interruption, the oven will shut off. When power is returned the oven will not turn back on automatically. The oven will remember that it is set for the Sabbath and the food may be safely removed from the oven while still in the Sabbath feature, however the oven cannot be turned back on until after the Sabbath.

After the Sabbath observance turn OFF the Sabbath feature. Press and hold both the  and  pads for at least 3 seconds. **SAb** will disappear from the display and the oven may be used with all normal functions. For further assistance, guidelines for proper usage, and a complete list of models with the Sabbath feature, please visit the web at <http://www.star-k.org>.

# Wall Oven Self-Cleaning Cycle

**CAUTION** During the self-cleaning cycle, the outside of the oven can become very hot to the touch. **DO NOT** leave small children unattended near the appliance.

**CAUTION** The health of some birds is extremely sensitive to the fumes given off during the self-clean cycle of any wall oven. Move birds to another well ventilated room.

**CAUTION** **DO NOT** line the oven walls, racks, bottom or any other part of the appliance with aluminum foil. Doing so will destroy heat distribution, produce poor baking results and cause permanent damage to the interior (aluminum foil will melt to the interior surface of the oven).

**CAUTION** **DO NOT** force the oven door open. This can damage the automatic door locking system. Use caution when opening the door after the Self-Cleaning cycle is completed. The oven may still be **VERY HOT**.



Note: See additional cleaning information for the oven door in the **General Care & Cleaning** section.

**CAUTION** The oven bake and broil elements may appear to have cooled after they have been turned OFF. **The elements may still be hot** and burns may occur if these elements are touched before they have cooled sufficiently.

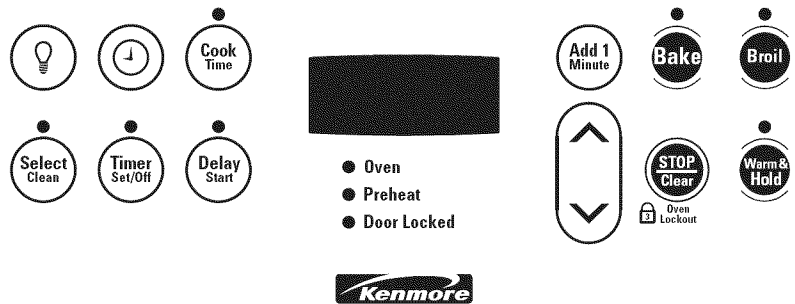

## Self-Cleaning Oven

A Self-Cleaning oven cleans itself with high temperatures (well above cooking temperatures) which eliminate soils completely or reduces them to a fine powdered ash you can wipe away with a damp cloth.

### Adhere to the following cleaning precautions:

- Allow the oven to cool before cleaning.
- Wear rubber gloves when cleaning any exterior parts of the oven manually.
- **DO NOT** clean the oven door gasket. The woven material of the oven door gasket is essential for a good seal. Care should be taken not to rub, damage or remove the gasket.
- **DO NOT** use any cleaning materials on the oven door gasket. Doing so could cause damage.
- **Remove all utensils and any aluminum foil from the oven. These items cannot withstand high cleaning temperatures.**
- This oven comes with lubricated porcelain oven racks, which can remain in the oven during the self-clean cycle. Do not clean this vegetable oil lubrication off the racks. It is important that the sides of the oven racks always have a light coating of vegetable oil. To maintain optimal rack performance, re-apply a thin layer of vegetable oil to the sides of the rack after every self-clean cycle or when the rack becomes difficult to slide.
- **Remove any excessive spillovers** in the oven cavity **before** starting the Self-Cleaning cycle. To clean, use hot, soapy water and a cloth. Large spillovers can cause heavy smoke or fire when subjected to high temperatures. **DO NOT** allow food spills with a high sugar or acid content (such as milk, tomatoes, sauerkraut, fruit juices or pie filling) to remain on the surface as they may leave a dull spot even after cleaning.
- Clean any soil from the oven frame, the door liner outside the oven door gasket and the small area at the front center of the oven bottom. These areas heat sufficiently to burn soil on. Clean with soap and water.

**NOTE:** Prior to setting the Self-Clean cycle, any spills remaining on the oven bottom should be removed.

Some models have an exposed Bake element in the wall oven cavity. On these models the bake element is designed to be tilted up using your hand from the front of the bake element. This will allow easier access to the oven bottom for cleaning. Be careful not to raise the element more than 4 or 5 inches from the resting position.

# Wall Oven Self-Cleaning Cycle

## What to Expect during Cleaning:

While the oven is in operation, the oven heats to temperatures much higher than those used in normal cooking. Sounds of metal expansion and contraction are normal. Odor is also normal as the food soil is being removed. Smoke may appear through the oven vent.







If heavy spillovers are not wiped up before cleaning, they may flame and cause more smoke and odor than usual. This is normal and safe and should not cause alarm. If available, use an exhaust fan during the self-cleaning cycle.

## Self-Clean Cycle time length

For satisfactory results, use a 2 hour Self-Clean cycle for **light soils** and a 3 hour cycle for **average** or a 4 hour cycle for **heavy soils**. **NOTE:** The kitchen area should be well ventilated using an open window, ventilation fan or exhaust hood during the Self-Clean cycle. This will help eliminate the normal odors associated with the Self-Clean cycle.

## To Set the Controls for a Self-Clean Cycle or a Delayed Start Self-Clean Cycle:

(Note: If you do not want to start a **Delayed** Self-Clean Cycle, skips steps 2 & 3.)

1. Be sure the clock shows the correct time of day.
2. Press .
3. Press and hold the  pad to scroll to the desired start time of the delayed Self-Clean cycle. Release the pad when the desired time is displayed.
4. Press . "- -" appears in the display.
5. Press the  or  once. "3:00" appears in the display for a 3 hour cycle. To change to a 2 hour cycle press . "2:00" appears in the display or to select a 4 hour cycle press . "4:00" appears in the display. As soon as the controls are set, the motor driven lock will begin to close automatically and the "Door Locked" indicator light will flash. **DO NOT** open the oven door while the light is flashing (it takes about 15 seconds for the oven door to lock).
6. "CLn" will appear in the display during the Self-Clean cycle and the "Door Locked" light will glow until the Self-Cleaning cycle is complete or cancelled and the oven temperature has cooled.

## When the Self-Clean Cycle is Completed:

1. The time of day or "End" will appear in the display window and the "Clean" and "Door Lock" light will continue to glow.
2. Once the oven has cooled down for about 1 HOUR and the "Door Lock" light has gone out, the oven door can be opened.
3. If "End" is in the display and the Select Clean indicator light remains ON, press . The time of day will appear in the display.

**NOTE:** When the oven is cool, wipe away any residue or powdered ash with a damp cloth or paper towel.

## Stopping or Interrupting a Self-Cleaning Cycle

If it becomes necessary to stop or interrupt a Self-Cleaning cycle:

1. Press .
2. Once the oven has cooled down for about 1 HOUR and the "Door Lock" light has gone out, the oven door can be opened.
3. Restart the Self-Clean cycle once all conditions have been corrected.

**NOTE:** A smoke eliminator in the oven vent converts most of the smoke into a colorless vapor.

**CAUTION** To avoid possible burns use care when opening the oven door after the Self-Cleaning cycle. Stand to the side of the oven when opening the door to allow hot air or steam to escape.

**CAUTION DO NOT** force the oven door open. This can damage the automatic door locking system. Use caution and avoid possible burns when opening the door after the Self-Cleaning cycle has completed. The oven may still be **VERY HOT**.

# Microwave General Care & Cleaning

## Cleaning Various Parts of Your Microwave Oven

Before cleaning any part of the oven, be sure all controls are turned OFF and the oven is COOL. REMOVE SPILLOVERS AND HEAVY SOILING AS SOON AS POSSIBLE. REGULAR CLEANINGS NOW WILL REDUCE THE EXTENT AND DIFFICULTY OF MAJOR CLEANING LATER.

Surfaces	How to Clean
<b>Door</b>	Wipe the window on both sides with a damp cloth to remove any spills or splatters. Metal parts will be easier to maintain if wiped frequently with a damp cloth. Cleaners which are marked specifically for use with stainless steel may be used. Follow package directions exactly. Avoid the use of any harsh cleaner or one not marked for stainless steel use as they may stain, streak or dull the door surface.
<b>Touch Control Panel</b>	Care should be taken in cleaning the touch control panel. If the control panel becomes soiled, open the microwave oven door before cleaning. Wipe the panel with a cloth dampened slightly with water only. Dry with a soft cloth. Do not scrub or use any sort of chemical cleaners. Close door and touch <b>Stop/Clear</b> .
<b>Interior</b>	Cleaning is easy because little heat is generated to the interior surfaces; therefore, there is no baking and setting of spills or splattering. To clean the interior surfaces, wipe with a soft cloth and warm water. <b>DO NOT USE ABRASIVE OR HARSH CLEANERS OR SCOURING PADS.</b> For heavier soil, use baking soda or a mild soap; rinse thoroughly with hot water.
<b>Waveguide Cover</b>	The waveguide cover is located on the ceiling in the microwave oven cavity. It is made from mica so it requires special care. Keep the waveguide cover clean to assure good microwave oven performance. Carefully wipe with a damp cloth any food splatters from the surface of the cover immediately after they occur. Built-up splashes may overheat and cause smoke or possibly catch fire. <b>DO NOT REMOVE THE WAVEGUIDE COVER.</b>
<b>Odor Removal</b>	Occasionally, a cooking odor may remain in the microwave oven. To remove, combine 1 cup water, grated peel and juice of 1 lemon and several whole cloves in a 2-cup glass measuring cup. Boil for several minutes using 100% power. Allow to set in microwave oven until cool. Wipe interior with a soft cloth.
<b>Turntable / Turntable Support</b>	The turntable and turntable support can be removed for easy cleaning. Wash them in mild, sudsy water; for stubborn stains use a mild cleanser and non abrasive scouring sponge. They may also be dishwasher cleaned. Clean the turntable support in upper rack of dishwasher. The turntable motor shaft is not sealed, so excess water or spills should be wiped up immediately.

# Wall Oven General Care & Cleaning

## Cleaning Various Parts of Your Wall Oven

Before cleaning any part of the oven, be sure all controls are turned OFF and the oven is COOL. REMOVE SPILLOVERS AND HEAVY SOILING AS SOON AS POSSIBLE. REGULAR CLEANINGS NOW WILL REDUCE THE EXTENT AND DIFFICULTY OF MAJOR CLEANING LATER.

Surfaces	How to Clean
Aluminum (Trim Pieces) & Vinyl	Use hot, soapy water and a cloth. Dry with a clean cloth. Do not scour or use all-purpose cleaners, ammonia, powdered cleaners or commercial oven cleaner. They can scratch and discolor aluminum.
Painted and Plastic Control Panel, Body Parts, and Decorative Trim	<p><i>For general cleaning</i>, use hot, soapy water and a cloth. <i>For more difficult soils and built-up grease</i>, apply a liquid detergent directly onto the soil. Leave on soil for 30 to 60 minutes. Rinse with a damp cloth and dry. <b>DO NOT</b> use abrasive cleaners on any of these materials; they can scratch.</p> <p>To remove control knobs, turn to the OFF position; grasp firmly and pull straight off the shaft. To replace knobs after cleaning, line up the flat sides of both the knob and the shaft; then push the knob into place.</p>
Stainless Steel, Chrome Control Panel, Decorative Trim	<p><i>Before cleaning the control panel</i>, turn all controls to OFF and remove the control knobs. To remove, pull each knob straight off the shaft. Clean using hot, soapy water and a dishcloth. Rinse with a clean water using a dishcloth. Be sure to squeeze excess water from the cloth before wiping the panel; especially when wiping around the controls. Excess water in or around the controls may cause damage to the appliance. To replace knobs after cleaning, line up the flat sides of both the knob and the shaft; then push the knob into place.</p> <p>Clean <b>stainless steel</b> with hot, soapy water and a dishcloth. Rinse with clean water and a cloth. <b>Do not use cleaners with high concentrations of chlorides or chlorines.</b> Do not use harsh scrubbing cleaners. Only use kitchen cleaners that are especially made for cleaning stainless steel. Always be sure to rinse the cleaners from the surface as bluish stains may occur during heating that cannot be removed.</p>
Porcelain Enamel Broiler Pan and Insert (some models), Door Liner, Body Parts	Gentle scouring with a soapy scouring pad will remove most spots. Rinse with a 1:1 solution of clear water and ammonia. <i>If necessary</i> , cover difficult spots with an ammonia-soaked paper towel for 30 to 40 minutes. Rinse with clean water and a damp cloth, and then scrub with a soap-filled scouring pad. Rinse and wipe dry with a clean cloth. Remove all cleaners or the porcelain may become damaged during future heating. <b>DO NOT</b> use spray oven cleaners on the cooktop.
Oven Racks	<p>This oven comes with lubricated porcelain oven racks, which can remain in the oven during the self-clean cycle. Do not clean this vegetable oil lubrication off the racks. It is important that the sides of the oven racks always have a light coating of vegetable oil. To maintain optimal rack performance, re-apply a thin layer of vegetable oil to the sides of the rack after every self-clean cycle or when the rack becomes difficult to slide.</p> <p>For some models with chrome oven racks, clean by using a mild, abrasive cleaner following manufacturer's instructions. Rinse with clean water and dry.</p>
Oven Door	<p>Use soap &amp; water to thoroughly clean the top, sides and front of the oven door. Rinse well. You may use a glass cleaner on the outside glass of the oven door. <b>DO NOT</b> immerse the door in water. <b>DO NOT spray or allow water or the glass cleaner to enter the door vents.</b> <b>DO NOT</b> use oven cleaners, cleaning powders or any harsh abrasive cleaning materials on the outside of the oven door.</p> <p><b>DO NOT</b> clean the oven door gasket. The oven door gasket is made of a woven material, on Self-Cleaning models, which is essential for a good seal. Care should be taken not to rub, damage or remove this gasket.</p>

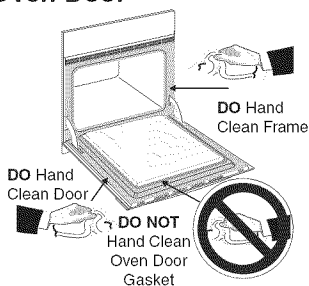
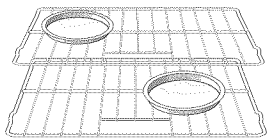

## Wall Oven General Care & Cleaning (continued)

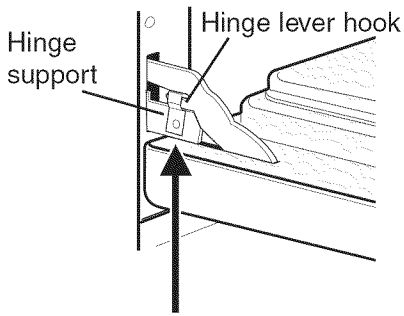

Lock engaged for door removal  
Figure 1

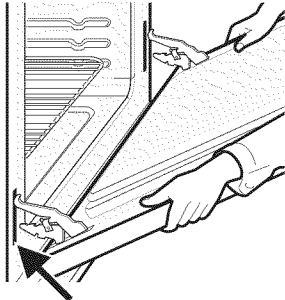

HINGE SLOT - Door removed  
from the oven  
Figure 2

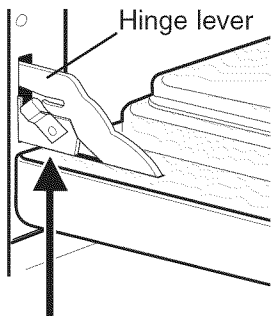

Lock in normal position  
Figure 3

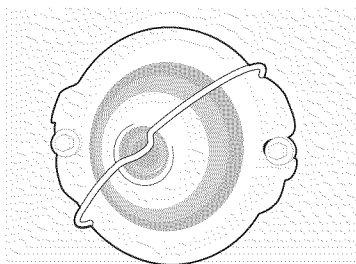

### Removing and Replacing the Oven Door

**CAUTION** The door is heavy. For safe, temporary storage, lay the door flat with the inside of the door facing down.

#### To Remove Oven Door:

1. Open the door to the fully opened position.
2. Pull up the lock located on both hinge supports and engage it in the hinge lever hooks (Figure 1). You may have to apply a little downward pressure on the door to pull the locks fully over the hinge lever hooks.
3. Grab the door by the sides and pull the bottom of the door up and toward you to disengage the hinge supports. Keep pulling the bottom of the door toward you while rotating the top of the door toward the range to completely disengage the hinge levers (Figure 2).
4. To clean oven door, follow the instructions provided in the **General Care & Cleaning** table.

#### To Replace Oven Door:

1. Grab the door by the sides; place the hinge supports in the hinge slots. Open the door to the fully opened position.
2. Disengage the lock from the hinge lever hooks on both sides (Figure 3).  
Note: Make sure the hinge supports are fully engaged before unlocking the hinge levers.
3. Close the oven door.

### Special Door Care Instructions

Most oven doors contain glass that can break.

Read the following recommendations:

1. Do not close the oven door until all the oven racks are fully in place.
2. Do not hit the glass with pots, pans, or any other object.
3. Scratching, hitting, jarring or stressing the glass may weaken its structure causing an increased risk of breakage at a later time.

### Changing the Oven Light

On some models an interior oven light will turn automatically when the oven door is opened. The oven light may be turned on when the door is closed by

pushing  located on the control panel. On some models, the lamp is covered with a glass shield held in place by a wire holder. **THE GLASS SHIELD MUST BE IN PLACE WHENEVER THE OVEN IS IN USE.**

#### To replace the light bulb:

**CAUTION: BE SURE THE OVEN IS COOL.**

1. Turn the power off at the main source.
2. Wear a leather-faced glove for protection against possible broken glass.
3. Replace bulb with 40-watt appliance bulb only.
4. For models with glass shield, press holder on one side to release glass shield, change bulb and be sure to replace the glass shield.



### Care and Cleaning of Stainless Steel (some models)

Some models are equipped with stainless steel exterior parts. Special care and cleaning are **required** for maintaining the appearance of stainless steel parts. Please refer to the table provided at beginning of this **General Care & Cleaning** section in this Use & Care Manual.

## Adjusting the Wall Oven Temperature

Your oven thermostat has been precisely set at the factory. This setting may differ from your previous oven, however, so your recipe times may not give you the results you expect. If you think that the oven is cooking too hot or cool for your recipe times, you can adjust the thermostat so that the oven cooks hotter or cooler than the temperature displayed.

### To Adjust Oven Temperature:

1. Press and hold  pad for 8 seconds. The display now indicates the amount of degrees offset between the original factory temperature setting and the current temperature setting. If the oven control has the original factory calibration, the display will read "0".
2. The temperature can now be adjusted up or down 35°F or 19°C, in 1°F or 1°C steps by pushing and holding the  or . Adjust until the desired amount of degrees offset appears in the display. When lowering the oven temperature, a minus sign (-) will appear before the number to indicate that the oven will be cooler by the displayed amount of degrees.
3. When you have made the desired adjustment, wait 5 seconds and the timer will go back to the time of day display.

**Note:** Oven temperature adjustment made will not change the Broil or Self-Cleaning feature temperature.

## Before You Call

### Solutions to Common Problems

*Before you call for service*, review this list. It may save you time and expense. The list includes common occurrences that are not the result of defective workmanship or materials in this appliance.

OCCURRENCE	POSSIBLE CAUSE/SOLUTION
<b>Control pads for Sensor Cooking, One-Touch Cooking, and Defrost will not operate.</b>	The oven door was opened and closed without initiating a cooking cycle within three minutes. Touch <b>STOP/CLEAR</b> to resume normal pad operation.
<b>Microwave oven light does not come on. Cooling fan does not work. Turntable does not rotate.</b>	If one of those situation appear please check the electrical outlet, fuse and/or circuit breaker. If they are functioning properly, contact Sears Part & Repair. A microwave oven should never be serviced by a "do-it-yourself" repair person.
<b>Water in a cup in microwave does not warm.</b>	If this situation appears please check the electrical outlet, fuse and/or circuit breaker. If they are functioning properly, contact Sears Part & Repair. A microwave oven should never be serviced by a "do-it-yourself" repair person.
<b>Time appearing in the display is counting down very rapidly.</b>	Please check Demonstration Mode on page 16 and cancel.
<b>Wall Oven Control Beeps and Displays any F code error (example F11).</b>	Electronic control has detected a fault condition. Press <b>STOP/CLEAR</b> to clear the display and stop the beeping. Reprogram the oven. If a fault reoccurs, record the fault number. Press <b>STOP/CLEAR</b> and call Sears or another qualified servicer.
<b>-dr- is displayed.</b>	The door was left open and controls set for self-cleaning cycle. Close the door and push <b>CANCEL pad</b> .
<b>Installation.</b>	Place oven rack in center of oven. Place a level on the oven rack. Contact installing agent if rack and cabinet cutout flooring are not level.  Kitchen cabinet misalignment may make oven appear to be not level. Be sure cabinets are square and level. Contact cabinet maker to correct problem.
<b>Entire Wall oven does not operate.</b>	When the oven is first plugged in, or when the power supply to the oven has been interrupted, the display will flash. The oven cannot be programmed until the clock is set.  Be sure electrical cord is securely connected into the electrical junction box.  Cord/plug is not installed and/or connected. Cord is not supplied with oven. Contact Sears or another qualified servicer.  Service wiring not complete. Contact Sears or another qualified servicer.  Power outage. Check house lights to be sure. Call your local electric company.  Short in cord/plug. Replace cord/plug.  Controls are not set properly. See instructions under <b>Setting Oven Controls</b> to set the controls.  House fuse has blown or circuit breaker has tripped immediately following installation. House fuse may not be fully engaged. Check fuse and screw or engage circuit breaker securely.  House fuse has blown or circuit breaker has tripped after the oven has been installed and previously operating. Call Sears or another qualified servicer.

## Before You Call

### Solutions to Common Problems

OCCURRENCE	POSSIBLE CAUSE / SOLUTION
Wall oven light does not work.	Burned-out or loose bulb. Follow the instructions under <b>Changing Oven Light</b> to replace or tighten the bulb.
Wall oven fan noise during cooking operation.	A cooling fan may automatically turn on and off to cool internal parts. This is normal, and the fan may continue to run even after oven is turned off.
Oven smokes excessively during broiling.	Oven door is closed. Door should be open during broiling.
	Meat too close to the broiler unit. Reposition the rack to provide more clearance between the meat and the broiler. Preheat broil element for quick searing operation.
	Meat not properly prepared. Remove excess fat from meat. Slash remaining fatty edges to prevent curling, but do not cut into the lean.
	Grid on broiler pan wrong side-up. Grease does not drain into broiler pan. Always place the grid on the broiler pan with the ribs up and the slots down to allow grease to drip into the pan.
	Broiler pan used without grid or grid cover with foil. <b>DO NOT</b> use the broiler pan without the grid or cover the grid with foil.
	Oven needs to be cleaned. Grease has built up on oven surfaces. Regular cleaning is necessary when broiling frequently. Old grease or food spatters cause excessive smoking.
Poor baking results.	Many factors affect baking results. See <b>Oven Baking</b> for hints, causes and corrections. See <b>Adjusting Oven Temperature</b> .
Self-cleaning cycle does not work.	Make sure the oven door is closed.
	Controls not set properly. Follow instructions.
	Self-cleaning cycle was interrupted. Stop time must be set 2-4 hours past the start time. Follow steps under "Stopping or Interrupting a Self-Cleaning Cycle" in this Use & Care Guide.
Soil not completely removed after self-cleaning cycle is completed.	Failure to clean bottom, from top of oven, frame of oven or door area outside oven seal. These areas are not in the self-cleaning area, but get not enough to burn on residue. Clean these areas before the self-cleaning cycle is started. Burned on residue can be cleaned with a stiff nylon brush and water or a nylon scrubber. Be careful not to damage the oven gasket.
	Excessive spillovers in oven. Set the self-clean cycle for longer cleaning time.
Flames inside oven or smoke from vent.	Excessive spillovers in oven. This is normal, especially for high oven temperatures, pie spillovers or for large amounts of grease on bottom of oven. Wipe up excessive spillovers.

# Get it fixed, at your home or ours!

## Your Home

For expert troubleshooting and home solutions advice:

**manage my home**

[www.managemyhome.com](http://www.managemyhome.com)

For repair – **in your home** – of **all** major brand appliances, lawn and garden equipment, or heating and cooling systems, **no matter who made it, no matter who sold it!**

For the replacement parts, accessories and owner's manuals that you need to do-it-yourself.

For Sears professional installation of home appliances and items like garage door openers and water heaters.

**1-800-4-MY-HOME<sup>®</sup>** (1-800-469-4663)

Call anytime, day or night (U.S.A. and Canada)

[www.sears.com](http://www.sears.com)    [www.sears.ca](http://www.sears.ca)

## Our Home

For repair of carry-in items like vacuums, lawn equipment, and electronics, call anytime for the location of your nearest

**Sears Parts & Repair Service Center**

**1-800-488-1222** (U.S.A.)

[www.sears.com](http://www.sears.com)

**1-800-469-4663** (Canada)

[www.sears.ca](http://www.sears.ca)

To purchase a protection agreement on a product serviced by Sears:

**1-800-827-6655** (U.S.A.)

**1-800-361-6665** (Canada)

Para pedir servicio de reparación a domicilio, y para ordenar piezas:

**1-888-SU-HOGAR<sup>®</sup>**

(1-888-784-6427)

Au Canada pour service en français:

**1-800-LE-FOYER<sup>MC</sup>**

(1-800-533-6937)

[www.sears.ca](http://www.sears.ca)

**Sears**