



5 SPEED DIGITAL JUICE EXTRACTOR

Instruction Manual



Thank You for your purchase

Register & sign up for special
announcements and trendy recipes!

Tell us what you think!
Rate, review or ask us a question.

@bellahousewares.com
#getinspired



BellaLife



BellaLifestyle



TABLE OF CONTENTS

Important Safeguards	1-2
Additional Important Safeguards	3
Notes On The Plug	4
Notes On The Cord	4
Plasticizer Warning	5
Electric Power	5
Getting to know your 5 Speed Digital Juice Station	6
Before Using For The First Time	7
Assembly instructions	8-9
Preparing fruits and vegetables for your 5 speed digital juice extractor	10-11
Operating instructions	11-12
Manual thermal protection	13
Disassembly instructions	13
User maintenance instructions	13
Care & cleaning instructions	13-14
Storing instructions	15
Troubleshooting	15-16
Recipes	17-19
Warranty	20-21

IMPORTANT SAFEGUARDS

When using electrical appliances, basic safety precautions should always be followed including the following:

1. **Read all instructions.**
2. To protect against risk of electrical shock do not put cord, plugs, or appliance in water or other liquid.
3. This appliance is not intended for use by persons (including children) with reduced physical, sensory or mental capabilities, or lack of experience and knowledge, unless they have been given supervision or instruction concerning use of the appliance by a person responsible for their safety.
4. Close supervision is necessary when any appliance is used by or near children. Children should be supervised to ensure that they do not play with the appliance.
5. Turn the appliance OFF. Unplug from outlet when not in use, before putting on or taking off parts, and before cleaning. To unplug, grasp the plug and pull from the outlet. Never pull from the power cord.
6. Avoid contacting moving parts.
7. Do not operate any appliance with a damaged cord or plug or after the appliance malfunctions, or is dropped or damaged in any manner. Contact the manufacturer at their customer service telephone number for information on examination, repair, or adjustment.
8. The use of attachments, including canning jars, not recommended by the manufacturer may cause fire, electric shock, or injury.
9. Do not use outdoors.
10. Do not let cord hang over edge of table or counter. Do not touch sharp blade in the base of the juicing disc.

11. Do not let cord contact any hot surface, including the stove. Make sure the juicer is properly assembled before operating.
12. Always make sure the juice extractor cover is locked securely in place before the extractor is turned on. Do not unfasten locking bar while the juice extractor is in operation. Vibration can occur during normal operation.
13. Turn the speed dial to Power (OFF) and unplug from electrical outlet after each use of your juice extractor. Make sure the motor is completely stopped before disassembling. Do not use any frozen fruit/vegetables in this machine. This juicer is designed to juice fresh fruits and vegetables only.
14. Do not put your fingers or other objects into the juice extractor opening while it is in operation. If food becomes lodged in the feed tube, use the food pusher or another piece of fruit or vegetable to push it down. When this method is not possible, turn the speed dial to Power (OFF), unplug the juice extractor from the electrical outlet, and disassemble the juice extractor to remove remaining food. When juicing hard fruits or vegetables, always juice on the high speed settings (settings 4 or 5). Failure to do so will cause damage to the juicer motor. Do not juice harder fruits on any of the lower speed settings which is meant for juicing softer fruits and vegetables.
15. Do not use the appliance if the rotating juicing blades and basket are damaged.
16. Use care when handling the stainless steel blade basket. Hold the basket's rim only. Do not touch the cutter blades on the bottom of the basket. The cutter blades are very sharp!
17. Do not operate without the pulp container in place. Please see assembly instructions for proper placement.

FOR HOUSEHOLD USE ONLY

ADDITIONAL IMPORTANT SAFEGUARDS

1. All users of this appliance must read and understand this instruction manual before operating or cleaning this appliance.
2. The cord to this appliance should be plugged into a 120V AC electrical outlet only.
3. Do not leave this appliance unattended during use.
4. If this appliance begins to malfunction during use, immediately turn the speed dial to Power (OFF) and unplug the cord.
Do not use or attempt to repair the malfunctioning appliance.
5. If this appliance falls or accidentally becomes immersed in water, unplug it immediately. Do not reach into the water! Do not use this appliance after it has fallen into or becomes immersed in water.
6. To reduce the risk of injury to persons or property, never use this appliance in an unstable position.
7. Do not use this appliance for other than its intended use.
8. Pay special attention to the amount of pulp and residue produced while juicing. Always empty a full pulp container before continuing to juice.
9. Always ensure that the anti-drip spout is in the OPEN position when juicing. The anti-drip spout should only be used to prevent dripping when the juice jar is removed.

SAVE THESE INSTRUCTIONS

NOTES ON THE PLUG

This appliance has a polarized plug (one blade is wider than the other). To reduce the risk of electric shock, this plug will fit in a polarized outlet only one way. If the plug does not fit fully into the outlet, reverse the plug. If it still does not fit, contact a qualified electrician. Do not modify the plug in any way.

NOTES ON THE CORD

The provided short power-supply cord (or detachable power-supply cord) should be used to reduce the risk resulting from becoming entangled in or tripping over a longer cord. If an extension cord is used:

1. The marked electrical rating of the cord or extension cord should be at least as great as the electrical rating of the appliance;
2. If the appliance is of the grounded type, the extension cord should be a grounding-type 3-wire cord; and
3. The longer cord should be arranged so that it does not drape over the countertop or table top where it can be pulled on by children or tripped over unintentionally.

PLASTICIZER WARNING

CAUTION: To prevent Plasticizers from migrating from the finish of the counter top or table top or other furniture, place **NON-PLASTIC** coasters or place mats between the appliance and the finish of the counter top or table top. Failure to do so may cause the finish to darken; permanent blemishes may occur or stains can appear.

ELECTRIC POWER

If the electrical circuit is overloaded with other appliances, your appliance may not operate properly. It should be operated on a separate electrical circuit from other appliances.

GETTING TO KNOW YOUR 5 SPEED DIGITAL JUICE STATION

Product may vary slightly from illustration

1. Food Pusher
2. Extra Wide Feed Tube
3. Clear Juicer Cover
4. Locking Bar Slots
5. Pulp Spout Cover
6. Cutter Blades
7. Stainless Steel Blade Basket
8. Pulp Spout
9. Juice Bowl Lip
10. Juice Bowl
11. Anti-drip Spout
12. Safety locking bar
13. Motor Hub
14. Motor Base
15. Speed Selector Knob
16. Polarized Plug
17. Rubber Feet
18. Pulp Container
19. Juice Jug Lid
20. Juice Jug
21. Cleaning Brush

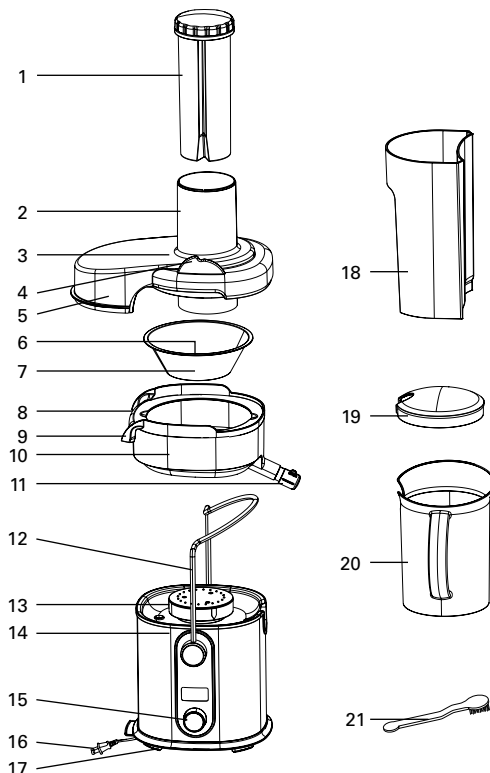

BEFORE USING FOR THE FIRST TIME

The juice extractor comes almost completely assembled in the box.

1. Your extractor may be shipped with a protective cardboard insert between the clear cover and the blade basket. Remove this and any other protective packaging before using your juice extractor. Also included in the box is a cleaning brush.
2. Following the disassembly instructions, remove the food pusher from the feed tube, then the cover, juice bowl with stainless steel blade basket.
3. Wash all removable parts (food pusher, clear cover, juice bowl, pulp basket, and juice jug with lid) in warm water with a biodegradable, non-abrasive liquid detergent. Rinse well and air-dry. This will eliminate any traces of dust or residue from manufacturing or shipping.

Caution: Use care when handling the blade basket. Hold the basket's rim only. Do not touch the cutter blades on the bottom of the basket. The cutter blades are very sharp!

Caution: Never rinse or immerse the motor base in water or any other liquid.

Assembly instructions

Warning: Always make sure the juice extractor is unplugged before starting assembly.

Important: The juice extractor is equipped with a safety system that prevents the extractor from being turned on unless the unit is completely and properly assembled.

1. Rotate the locking bar so that it sits at the front of the base (see figure 2).
2. Place the juice bowl on top of the motor base so that the juice spout fits into the cut out at the front of the base (see figure 3).

Caution: Use care when handling the stainless steel blade basket. Hold the basket's rim only. Do not touch the cutter blades on the bottom of the basket. The cutter blades are very sharp!

3. Set the stainless steel blade basket onto the motor hub in the center of the juice bowl (see figure 3). Press down on the blade basket's outer rim until it drops into place and is securely seated. Gently rotate the blade basket to ensure that it turns freely. If initially it fails to seat, this should slip it into place. Double check by pressing down on the rim and spinning it again.
4. Align the cover so that the pulp cover fits over the back of the base. (see figure 4).
5. Turn the food pusher so that the groove in the side lines up with the tab in the feed tube. Insert the food pusher into the feed tube (see figure 5). Store the food pusher in the feed tube of the lid until the produce is ready to juice.

Figure 2

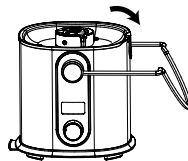

Figure 3

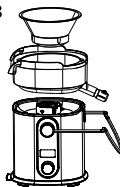

Figure 4

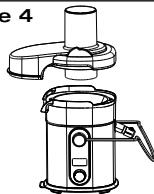
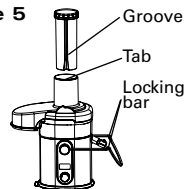

Figure 5



6. Push the safety locking bar up and over the lid. Make sure the lid is locked securely into place (see figure 6).
7. Add the pulp basket (see figure 7). Tilt the pulp basket slightly so that the lip of the juice bowl fits snugly over the inside of the pulp basket. Push the bottom of the pulp basket so that it rests securely on its platform.

Important: To avoid spillage, make sure the pulp basket sits flush up against the base.

Note: To save cleaning time, line the pulp basket with a plastic grocery store produce bag.

8. Make sure the anti-drip spout is properly open (see figure 8).
9. Add the juice jug lid to the juice jug so that the lid's cut out fits over the pitcher's pouring spout. Tilt the juice jug slightly so that the extractor's juice spout fits into the top of the pitcher lid (see figure 7). This will prevent juice spillage.

Figure 6

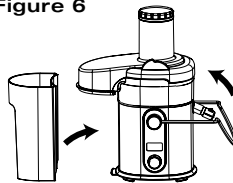

Figure 7

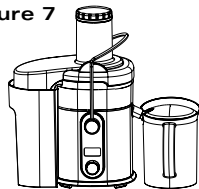
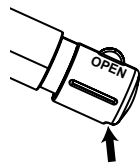

Figure 8



Preparing fruits and vegetables for your 5 speed digital juice extractor

- Clean all produce thoroughly, using a natural bristle brush. If you are not using organic produce, we recommend using a biodegradable cleaner to help remove pesticide residue.
- Remove and discard the outer leaves of non-organic produce and peel any waxed fruit or vegetable.
- Trim away any discolored or bruised sections.
- The skin may be left on all produce (including pineapple and melons) except oranges, grapefruit, and tangerines. The oil found in these skins tastes bitter and is difficult to digest.
- Remove melon seeds when possible, as they may escape through the top of the feed tube while juicing. The pits of fruits such as cherries, pears, and peaches should also be removed.
- Cut produce into pieces small enough to fit into the feed tube. Use the food pusher to gently direct produce through the tube. Never push produce into the feed tube with your fingers.
- It may be necessary to cut hard produce (carrots, beets, pineapple, etc.) into smaller pieces to facilitate juicing.
- Leafy greens, parsley, wheat grass, and sprouts should be bunched up into a small, tight ball and pushed through with either a carrot or the food pusher.
- Juicing herbs and leafy greens will yield a lower juice level due to the nature of the vegetable or greens. It is recommended to juice them in combination with other fruits and vegetables.
- Bananas are not suitable for juicing; a clear juice cannot be obtained from them and residue left in the machine can clog the micro-mesh screen.
- For best results when juicing apricots, plums, pears, peaches, and tomatoes, produce should be firm.
- When juicing apples, add a small amount of fresh lemon or lime to help slow down the browning process.

- Fruits that contain starch, such as bananas, papayas, avocados, figs and mangoes are not suitable for the juice extractor. Use a food processor, blender or bar blender to process these fruits.
- The juice extractor is not suitable for processing very hard and/or fibrous/starchy fruits or vegetables such as sugar cane.

Important: Always juice hard fruits (see detailed chart below) in the higher speed settings (settings 4 & 5). Failure to do so may result in a damaged motor and will cause the juicer to break.

Operating instructions

5 speed Dial control

Your juice extractor offers 5 speed options that ensure optimal rpm to provide maximum juicing efficiency.

Note: Efficiency describes the amount of juice extracted from your produce.

Speed	Description	Example
5	Hard Fruits / Vegetables	Beets, Carrots, Fennel, Brussel Sprouts
4	Celery / Leafy Greens	Pear, Celery, Cabbage, Cauliflower, Broccoli, Cucumber (with skin)
3	Apples	Peach, Apricots, Plums, Tomato, Apples, Pineapples
2	Citrus	Orange, Lime, Grapefruit, Lemon
1	Soft Fruits	Mango, Watermelon, grapes, Cucumbers (peel removed), Raspberries, Blueberries
0	Power (OFF)	Turn Off the machine; Ready to use

Important: The juice extractor is equipped with a safety system that prevents the Extractor from being turned on unless the unit is completely and properly assembled.

1. Assemble the juice extractor following the assembly instructions described in this manual.
2. Have all fruits and vegetables prepared for juicing.

3. To begin, plug the unit into a 120v ac electrical outlet. The LCD display will illuminate once you turn on the unit by selecting one of the 5 speed settings.
4. Once plugged in, the juicer will verify if the safety locking bar is properly fastened and securely locked in place. If the safety locking bar is not properly assembled, and the unit is turned on, the LCD will display “L” to inform the user that the unit is not properly secured and locked in place. However, if the unit is in the OFF position, and the safety locking bar is not properly locked into place, the unit will not power on. It is important to always ensure that the safety locking bar is properly secured and locked in place prior to juicing.
5. Remove the food pusher from the feed tube.
6. Turn the speed control dial to 5 to juice harder produce.
7. Turn the speed control dial to 1 to juice softer produce.

Note: When juicing a combination of hard and soft produce, such as beets, carrots and strawberry, you will want to use the highest speed setting (5) for beets and carrots and the lowest speed setting (1) for the strawberry. You do not have to turn the machine off to change speeds. Simply turn the dial to change to the appropriate speed for each type of produce being juiced.

Tip: To ensure maximum efficiency, alternate types of produce.

8. Once you have selected the desired speed setting for juicing and you are ready to begin juicing, place produce into the feed tube. Use the food pusher to gently direct through the feed tube and blade basket with the food pusher. When juicing is completed, turn the speed dial to Power (OFF).
9. Slide the juice jug out from the juice spout. Serve juice immediately for the freshest flavor and highest nutritional value.
10. Remove the pulp container and save or discard pulp.

Note: The pulp from your juice extractor can be used in many different applications such as breads, muffins, cakes, soup stocks, compressed facial packs and garden compost material.

11. Unplug the juice extractor from the outlet after use.
12. Follow disassembly instructions described in this manual; all removable parts should be rinsed and cleaned after each use. Clean the juice extractor following the procedures described in the care & cleaning instructions.

Manual Thermal Protector

This product is equipped with a Manual Resettable Thermal Protector to protect the motor. If the motor shuts down and LCD shows “E” and “1” flashing alternatively, turn the Speed Selector Knob to Off position, and then unplug the juice extractor. Let the unit rest for approximately half an hour. Once the resetting period has elapsed, plug the power cord back into the outlet and turn the Speed Selector Knob to the desired setting to continue.

Disassembly instructions

Warning: Always make sure juice extractor is unplugged before starting disassembly.

1. Remove the pulp basket and juice jug.
2. Lift the safety locking bar up and off the bar locking slots on the cover. Rest the locking bar at the front of the unit.
3. Lift juice extractor cover up and off the juice extractor.
4. Grasping the pulp spout in one hand and the back of the juice bowl in the other, loosen and lift the juice bowl and blade basket off as one piece. These 2 parts will then easily separate for easy cleaning.
Caution: Use care when handling the blade basket. Hold the basket’s rim only. Do not touch the cutter blades on the bottom of the basket. The cutter blades are very sharp!
5. Please follow the procedures outlined in the care & cleaning instructions for specific cleaning instructions.

User maintenance instructions

This appliance requires little maintenance. It contains no user serviceable parts. Do not try to repair it yourself. Any servicing that requires disassembly other than cleaning must be performed by a qualified appliance repair technician.

Care & cleaning instructions

1. Unplug from outlet. Please follow the procedures outlined in the disassembly instructions to remove parts before cleaning.
2. Clean unit and parts after each use.

3. Do not immerse the motor base in water or spray it with water. Clean only by wiping with a damp sponge, cloth, or paper towel. Use any liquid dishwashing detergent but do not use products containing ammonia or scouring powders. These products will dull, scratch or mark the surface.
4. If any juice has spilled under the juice extractor, clean legs and area with a lightly soaped sponge, then dry. Use a damp toothbrush or cloth to clean juice from inside the motor hub on top of the motor base.
5. All parts (except the blade basket and motor base) are washable in warm, soapy water or in the dishwasher.
6. When cleaning the blade basket, make sure the tiny holes in the basket are not clogged. This can be accomplished by holding the blade basket under running water faucet. Use the cleaning brush included in a circular motion to clean the basket holes from both inside and outside of the blade basket.
Caution: Use care when handling the blade basket. Hold the basket's rim only. Do not touch the cutter blades on the bottom of the basket. The cutter blades are very sharp!
Note: If necessary, allow the blade basket to soak in hot water with 10% lemon juice added.
7. The juice extractor clear cover, juice bowl, pulp jug, juice jug and juice jug lid may be washed in the top rack of a dishwasher. However, washing with warm (not hot) tap water on a daily basis should be sufficient.
8. Due to the powerful staining properties of the carotenoids that are found in many vegetables, especially carrots, we suggest soaking stained parts overnight in any of these 4 cleaning solutions:
 - Biodegradable soap in enough warm water to cover juice extractor parts
 - 1 part warm water to 1 part cider vinegar
 - 1/2 small box baking soda in enough warm water to cover parts.
 - Warm water with 10% lemon juice solution.

Caution: Never use ammonia or abrasives.

- Lightly clean with a sponge or kitchen rag and liquid detergent after soaking.

Warning: Never submerge the motor base in water or other liquid!

Storing instructions

1. Unplug unit, assemble clean, dry parts before storing.
2. Store the juice extractor in its box in a clean, dry place. Never store it while it is hot or still plugged in.
3. Store the food pusher in the feed tube of the lid.
4. Never wrap cord tightly around the appliance. Do not put any stress on the cord where it enters the unit; while holding the cord perpendicular to the unit, push inwards slowly to store it inside the base of the unit.

Troubleshooting

Symptom	Possible correction
The juice extractor will not turn on	<ul style="list-style-type: none">•The juice extractor is equipped with a safety system that prevents the extractor from being turned on unless the unit is completely and properly assembled.•Turn the speed dial to Power (OFF). Check to make sure the blade basket is properly seated.• Make sure the safety locking bar is securely locked into place on the top of the lid. (see figure 6.)The lid must be bared securely into place or the juice extractor will not turn on.
Excessive noise or vibrations occur after juice extractor is turned on.	<ul style="list-style-type: none">• Check to make sure the blade basket is properly seated.• Pulp may have built up on the blade basket. Clean the blade basket.•Try alternating different types of produce while juicing. <p>Note: Because of the juice extractor's powerful motor, a small amount of noise and/or vibration is normal when the extractor is turned on and as it comes to a complete stop. All juicers will sound slightly different.</p>

Symptom	Possible correction
Excessive noise or vibrations, unpleasant odor, appliance is hot to the touch, or the juice extractor smokes after it is turned on.	<ul style="list-style-type: none"> • Unplug the unit immediately. Take the juice extractor to a qualified appliance repair technician for servicing.
The blade basket is blocked. Food is jammed in the base of the feed tube; the juice extractor has stopped during juicing.	<ul style="list-style-type: none"> • Turn the speed selector dial to Power (OFF). Remove cover and clear feed tube. Chop fruits and vegetables into smaller pieces to facilitate juicing.
"E" Error on the LCD screen	<ul style="list-style-type: none"> • There was an error when turning on the juice extractor. • This product is equipped with a Manual Resettable Thermal Protector to protect the motor. If the motor shuts down and LCD shows "E" and "1" flashing alternatively, turn the Speed Selector Knob to Off position, and then unplug the juice extractor. Let the unit rest for approximately half an hour. Once the resetting period has elapsed, plug the power cord back into the outlet and turn the Speed Selector Knob to the desired setting to continue.
"L" on the LCD screen	<ul style="list-style-type: none"> • The locking bar is not securely locked into place. • The LCD will display "L" when the locking bar is down for safety measures to ensure that the locking bar is always properly secured and locked in place prior to juicing.

RECIPES

POMEGRANATES

Pomegranates are healthy, flavorful, delicious, and perfect to juice in the Juice Extractor. They are worth the trouble of de-skinning and removing the membranes.

Cut off the 2 pole ends. Scoop out the center core without disturbing the seeds. Using a sharp knife, score the outer skin and separate the pomegranate into sections. Place the sections in a bowl of water. With your fingers, working in the water, roll the juice sacs out of the papery inner membranes.

NOTE: The seeds will sink to the bottom, the membranes will float to the top.

Discard membranes and outer skin. Strain water and seeds are ready for extraction.

IMPORTANT: Juice pomegranates first at LOW speed into the clean pulp basket.

Then throw the pulp basket remains back into the Juice Extractor. Extract a second time.

POMEGRANATE HEAVEN

- 4 pomegranates, seeded (2 cups of seeds)
- 4 tangelos (or tangerines), skinned
- 2 pears, stems removed

JICAMA

Jicamas are traditionally used to relieve an upset stomach. They are a very good source of calcium and phosphorus.

JICAMA WATERMELON COCKTAIL

- 1/2 watermelon (seeds and rind included)
- 3 jicamas (peeled)
- Kosher salt

Add to chilled glasses with a pinch of kosher salt.

RECIPES

PINEAPPLES

The juice of the pineapple is rich in potassium, calcium, phosphorus and organic sulphur, moderate amounts of iron and Vitamins C and A. The beauty of juicing pineapples, is that the pulp is absolutely delicious when used in a varieties of recipes, from appetizers to desserts! Prepare sauces, jams, jelly, preserves, toppings, marinades, and salsas with fresh pineapple pulp. Juice the pineapple first. Empty the pulp basket into a storage container for use in any recipe. Pineapple pulp can be stored in zipper-lock freezer bags or ice cube trays and frozen for later use.

HOT MULLED SUNSHINE WITH PINEAPPLE STUFFED FRENCH TOAST

Enjoy a mug of Hot Mulled Sunshine with Pineapple Stuffed French Toast for a sweet and exotic breakfast on a cold winter day.

- 1 ripe pineapple, outer skin and top crown removed
- 1 navel orange, peeled
- 2 apples
- 1 cinnamon stick
- 8 whole cloves
- 2 tablespoons honey

Juice pineapple, orange and apples. Combine juice, cinnamon, cloves and honey in a medium sauce pan. Bring to a boil, then cover and reduce to a slow simmer for 15 minutes. Strain to remove the cinnamon stick and cloves.

RECIPES

PINEAPPLE STUFFED FRENCH TOAST

Serves 2

- 4 slices day-old brioche (egg bread)
- 1 jumbo egg, beaten
- 1 teaspoon milk or cream
- 6 teaspoons whipped cream cheese
- 3 teaspoons pineapple pulp
- 1 tablespoon honey
- 2 tablespoons melted butter
- 2 tablespoons vegetable oil
- 1/2 cup pineapple pulp for topping
- brown sugar for topping

Add 1 tablespoon butter plus 1 tablespoon vegetable to a medium skillet. Heat on medium-high. While the skillet is preheating, in a medium bowl, whisk the egg and milk together. In a small bowl, combine cream cheese, pineapple pulp and honey. Mix well.

Lay 4 slices of bread out and spread 1/2 of the pineapple cream cheese on one slice of brioche. Spread the remaining 1/2 on another. Cover with 2 remaining dry pieces of bread to form 2 sandwiches. Working 1 at a time, dip each sandwich in the egg mixture for about 1-1/2 minutes per side. When the skillet is hot, add the dipped French Toasts and fry in butter for 3 to 4 minutes until golden brown. Remove from skillet. Add 1 tablespoon butter plus 1 tablespoon vegetable to the skillet. Fry the second side for 3 to 4 minutes until golden brown. Remove to serving plates. Top each stuffed French toast with pineapple pulp and sprinkle with brown sugar.

VIRGIN EXTRACTOR MOJITO

Here's a healthy non-alcoholic version of a cocktail favorite.

- 2 cucumbers
- 2 large Anjou pears
- 1 large handfuls fresh mint
- 1 lime

EXTRACTOR APPLE PIE

- 1 tsp cinnamon
- 1 tsp nutmeg
- 8 large granny smith apples

Limited Two-Year Warranty

SENSIO Inc. hereby warrants that for a period of **TWO YEARS** from the date of purchase, this product will be free from mechanical defects in material and workmanship, and for 90 days in respect to non-mechanical parts. At its sole discretion, SENSIO Inc. will either repair or replace the product found to be defective, or issue a refund on the product during the warranty period.

Exclusions:

The warranty does not cover normal wear of parts or damage resulting from any of the following: negligent use of the product, use of improper voltage or current, improper routine maintenance, use contrary to the operating instructions, disassembly, repair, or alteration by anyone other than qualified SENSIO Inc. personnel. Also, the warranty does not cover Acts of God such as fire, floods, hurricanes, or tornadoes. SENSIO Inc. shall not be liable for any incidental or consequential damages caused by the breach of any express

The warranty is only valid for the original retail purchaser from the date of initial retail purchase and is not transferable. Keep the original sales receipt, as proof of purchase is required to obtain warranty validation. Retail stores selling this product do not have the right to alter, modify, or in any way revise the terms and conditions of the warranty.

or implied warranty. Apart from the extent prohibited by applicable law, any implied warranty of merchantability or fitness for a particular purpose is limited in time to the duration of the warranty. Some states, provinces or jurisdictions do not allow the exclusion or limitation of incidental or consequential damages, or limitations on how long an implied warranty lasts, and therefore, the above exclusions or limitations may not apply to you. The warranty covers specific legal rights which may vary by state, province and/or jurisdiction.

How To Obtain Warranty Service:

You must contact Customer Service at our toll-free number: 1-866-832-4843. A Customer Service Representative will attempt to resolve warranty issues over the phone. If the Customer Service Representative is unable to resolve the problem, you will be provided with a case number and asked to return the product to SENSIO Inc. Attach a tag to the product that includes: your name, address, daytime contact telephone number, case number, and description of the problem.

Also, include a copy of the original sales receipt. Carefully package the tagged product with the sales receipt, and send it (with shipping and insurance prepaid) to SENSIO Inc.'s address. SENSIO Inc. shall bear no responsibility or liability for the returned product while in transit to SENSIO Inc.'s Customer Service Center.



For customer service questions or comments
1-866-832-4843
bellahousewares.com

Sensio Inc.

New York, NY 10016/USA

90094_R14

