

*Thinking of you*

 **Electrolux**

User Manual

147753410

**Time Manager**

8Kg Perfect Wash System with Vapour Action

EFW 14811



**We were thinking of you**  
when we made this product

## **Welcome to the world of electrolux**

Thank you for choosing a first class product from Electrolux, which hopefully will provide you with lots of pleasure in the future. The Electrolux ambition is to offer a wide variety of quality products that make your life more comfortable. You find some examples on the cover in this manual. Please take a few minutes to study this manual so that you can take advantage of the benefits of your new machine. We promise that it will provide a superior User Experience delivering Ease-of-Mind. Good luck!

The symbols you will see on some paragraphs of this booklet have the following meaning:



The warning triangle and/or the key words (Warning!, Caution!) emphasize information that is particularly important for your safety or correct functioning of the appliance.



The information marked with this symbol provides additional instructions and practical tips on the use of the appliance.



Tips and information about economical and ecological use of the machine are marked with this symbol.

---

**Our contribution to the protection of the environment:  
we use environmentally friendly paper.**

---

## **CONTENTS**

Safety information .....	<b>3</b>
Product description .....	<b>5</b>
Control panel .....	<b>6</b>
Use .....	<b>7</b>
Washing hints .....	<b>20</b>
International wash code symbols .....	<b>23</b>
Washing program.....	<b>24</b>
Care and cleaning .....	<b>26</b>
Troubleshooting.....	<b>29</b>
Technical data .....	<b>33</b>
Installation .....	<b>34</b>
Environment concerns .....	<b>37</b>
Warranty.....	<b>38</b>

## SAFETY INFORMATION



**In the interest of your safety and to ensure the correct use, before installing and first using the appliance, read this user manual carefully, including its hints and warnings. To avoid unnecessary mistakes and accidents, it is important to ensure that all people using the appliance are thoroughly familiar with its operation and safety features. Save these instructions and make sure that they remain with the appliance if it is moved or sold, so that everyone using it through its life will be properly informed on appliance use and safety.**

### General safety

- It is dangerous to alter the specifications or attempt to modify this product in anyway.
- During high temperature wash program the door glass may get hot. Do not touch it!
- Make sure that small pets do not climb into the drum. To avoid this, please check into the drum before using the appliance.
- Any objects such as coins, safety pins, nails, screws, stones or any other hard, sharp material can cause extensive damage and must not be placed into the machine.
- Only use the advised quantities of fabric softener and detergent. Damage to the fabric can ensue if you overfill. Refer to the manufacturer's recommendations of quantities.
- This appliance is not intended for use by persons (including children) with reduced physical, sensory or mental capabilities, or lack of experience and knowledge, unless they have been given supervision or instruction concerning use of the appliance by a person responsible for their safety.
- Wash small items such as socks, laces, washable belts etc in a washing bag or pillow case as it is possible for such items to slip down between the tub and the inner drum.
- Do not use your washing machine to wash articles with whalebones, material without hems or torn material.
- Always unplug the appliance and turn off the water supply after use, clean and maintenance.
- Under no circumstances should you attempt to repair the machine yourself. Repairs carried out by inexperienced persons may cause injury or serious malfunctioning. Contact your local Service Centre. Always insist on genuine spare parts.

### Installation

- This appliance is heavy. Care should be taken when moving it.
- When unpacking the appliance, check that it is not damaged. If in doubt, do not use it and contact the Service Centre.
- All packing and transit bolts must be removed before use. Serious damage can occur to the product and to property if this is not adhered to. See relevant section in the user manual.

#### 4 electrolux **safety information**

- After having installed the appliance, check that it is not standing on the inlet and drain hose and the worktop is not pressing the electrical supply cable.
- If the machine is situated on a carpeted floor, please adjust the feet in order to allow air to circulate freely.
- Always be sure, that there is no water leakage from hoses and their connections after the installation.
- Any plumbing work required to install this appliance should be carried out by a qualified plumber.
- Any electrical work required to install this appliance should be carried out by a qualified electrician.

#### **Use**

- This appliance is intended to be used in household and similar applications such as:
  - Farm Houses.
  - By clients in serviced apartments, holiday apartments and other residential type environments.
- Only wash fabrics which are designed to be machine washed. Follow the instructions on each garment label.
- Do not overload the appliance. See the relevant section in the user manual.
- Before washing, ensure that all pockets are empty and buttons and zips are fastened. Avoid washing frayed or torn articles and treat stains such as paint, ink, rust, and grass before washing. Underwired bras must NOT be machine washed.
- Garments which have been in contact with volatile petroleum products should not be machine washed. If volatile cleaning fluids are used, care should be taken to ensure that the fluid is removed from the garment

before placing in the machine.

- Never pull the power supply cable to remove the plug from the socket; always take hold of the plug itself.
- Never use the washing machine if the power supply cable, the control panel, the working surface or the base are damaged so that the inside of the washing machine is accessible.

#### **Child safety**

- This washing machine is not intended for use by young children or infirm persons without supervision.
- Young children should be supervised to ensure that they do not play with the appliance.
- The packaging components (e.g. plastic film, polystyrene) can be dangerous to children - danger of suffocation! Keep them out of children's reach
- Keep all detergents in a safe place out of children's reach.
- Make sure that children or pets do not climb into the drum. To avoid this the machine incorporates special feature. To activate this device, rotate the button (without pressing it) inside the door clockwise until the groove is horizontal. If necessary use a coin. To disable this device and restore the possibility of closing the door, rotate the button anti-clockwise until the groove is vertical.

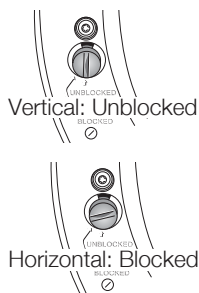
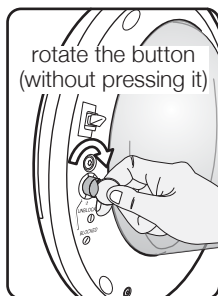

## PRODUCT DESCRIPTION

Your new Electrolux Time Manager with the Advanced Wash System delivers a host of special features to assist you in the laundry.

- Time Manager gives you the opportunity to program the washing machine not only by fabric or temperature but also by TIME, giving you the flexibility to adjust the washing time to suit the time you have available.
- The easy to use control panel gives you complete control over your washing including the ability to save your favourite personalised wash programs to use again and again whenever you need it.
- The jetsystem™ spray action allows the water level to be much lower - and gets water & detergent more effectively to all the wash.

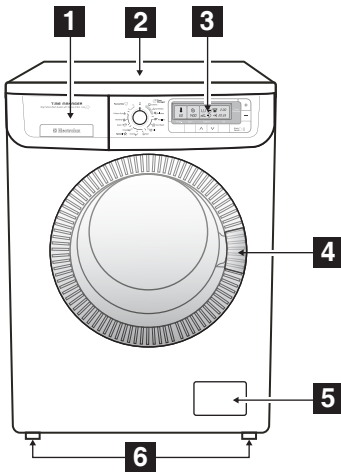

### Front Side View

- 1** Detergent Dispenser Drawer
- 2** Worktop
- 3** Control Panel
- 4** Door Opening Handle
- 5** Drain Pump
- 6** Front Feet

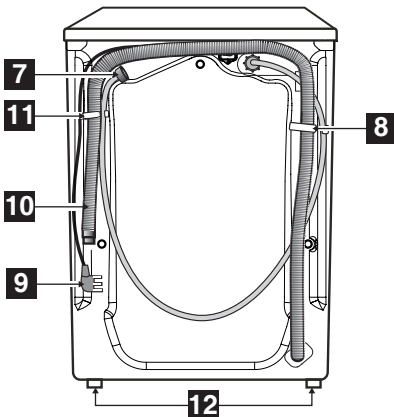



### Back Side View

- 7** Water Inlet Hose
- 8** Drain Hose Support
- 9** Mains Cable
- 10** Water Drain Hose
- 11** Hose Holders
- 12** Back Feet

## Detergent dispenser drawer

The detergent dispenser is divided into three compartments. The table of Washing Program shows which compartment to use.

- Compartment  : this compartment is only used for washing powder when a program has Prewash or Stain.
- Compartment  : this compartment is used for washing powder on all programs.
- Compartment  : this compartment is used for fabric conditioner and starching agent.

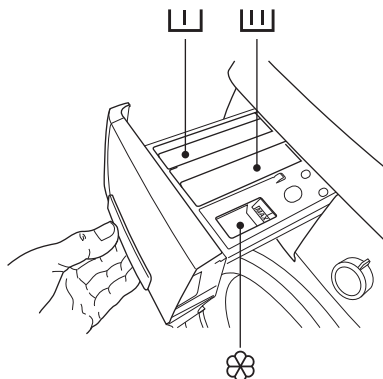

Always add laundry detergents before switching the machine on and keep the dispenser clean and dry, so that the detergent can be efficiently dispensed from the unit.

## CONTROL PANEL

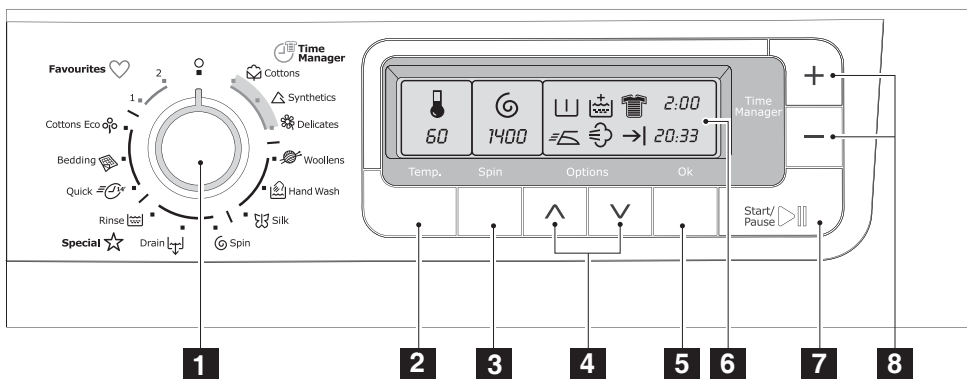

**1** Program Selector Dial

**2** Temperature Button

**3** Spin Button

**4** Option Button

**5** Confirm Button

**6** Display

**7** Start/Pause Button

**8** Time Manager Button

## USE

### First use



- Ensure that the electrical and water connections comply with the installation instructions.

#### Setting the language

When switching on the appliance for the first time, by turning the programme selector dial, you must set the language in which you want the indicators in the display to appear. When the appliance is switched on again all indicators in the display will appear in this language.

#### Important!

If the display is not showing any language, the appliance has already been switched on once. In such case, if you would change the language setting, press at the same time **Temp.** and **Spin** buttons for 6 seconds to activate the menu language. By pressing the **Options**  $\wedge \vee$  buttons you can scroll all the available languages. Press the **Ok** button twice to confirm your choice.

#### Setting the time

After having chosen the language you must set the time prior to the first wash and when changing to and from daylight savings time. The clock setting permits you to modify/set up the current time. It is important to keep it updated as the current END Cycle Time depends on it.

With a short/single time pressure of the «Options»  $\wedge \vee$  buttons, the time varies minute by minute. With a continue pressure of the same buttons, the time varies 10 minutes by 10 minutes. Press the **Ok** button to fix the current time.

### Daily use



#### Customize your appliance

This appliance is provided of a «settings» menu that allows you to modify the factory settings as you want.

When you switch on the machine, by turning the programme selector dial, press the «Options»  $\wedge \vee$  buttons to activate the Options menu. By pressing again the same buttons you can move through all the available options till when you locate the «Settings» menu. Press «Ok» to access in the menu. Use again «Up/Down» buttons to scroll all the settings and press «Ok» button to confirm your choice.

#### Setting the sound volume

The sound setting permits you to modify the volume of the sound emitter. By pressing the «Options»  $\wedge \vee$  buttons, you can choose between different volume levels from 0 to 9 (0 = no sound; 9 = max.).

Press **Ok** button to confirm your choice.

#### Setting the brightness

The Brightness setting allows you to modify the backlight intensity of the display.



By pressing the «Options»  $\wedge \vee$  buttons, you can increase or decrease the brightness.

You can choose between different levels from 0 to 9 (0 = min. - 9 = max.).

Press **Ok** button to confirm your choice.

#### Setting the contrast

The Contrast setting allows you to modify the optical characteristic of the display.

By pressing the «Options»   buttons, you can increase or decrease the contrast.

You can choose between different levels from 0 to 9 (0 = min. - 9 = max.).

Press **Ok** button to confirm your choice.

### Reset settings



The Reset setting function allows you to re-apply the factory settings.

Press **Ok** button to activate this function.

Press **Ok** button to confirm your choice.

### Return to main menu

This setting function allows you to return to the options menu.

Locate the «Back» option  by pressing the «Options»  .

Press **Ok** button to confirm your choice.

### Acoustic signals

The machine is provided with an acoustic device, which sounds in the following cases:

- when the appliance is switched on
- by pressing the Start/Pause button
- at the end of the cycle
- in the event of operating problems



If you want to disable the acoustic signals, except for the event of operating problems, please refer to the previous chapter «setting the sound volume».

### Load the laundry

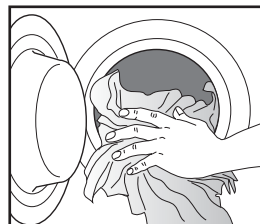
Open the door by carefully pulling the door handle outwards. Place the laundry in the drum, one item at a time, shaking them out as much as possible. Close the door.



### Measure out the detergent and the fabric softener

Pull out the dispenser drawer until it stops. Measure out the amount of detergent required, pour it into the main wash compartment  and, if you wish to carry out the «prewash» phase, pour it into the compartment marked .

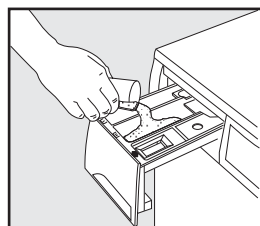

If required, pour fabric softener into the compartment marked  (the amount used must not exceed the «MAX» mark in the drawer).

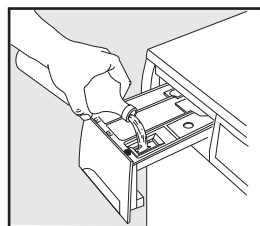

Close the drawer gently.

## Select the required program

Turn the programme selector dial to the required programme. When the appliance is switched on, a friendly jingle can be heard, at the same time the Electrolux logo appears on the display and, for few seconds, a short description of the selected programme is shown in last 2 rows of the display. After having selected the programme, the appliance will propose on the display the following information:

- 1** temperature
  - 2** spin speed
  - 3** selected option icons
  - 4** soil degree (\*)
  - 5** washing programme duration
  - 6** end of washing cycle
- (\*) Only with **Cottons**, **Synthetics** and **Delicates** programmes

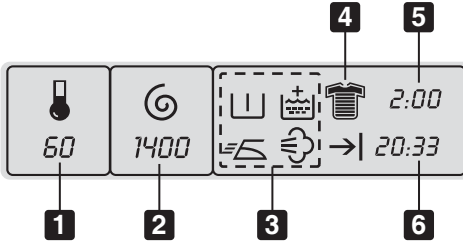

The **Start/Pause** button light will start flashing.

The selector dial is divided into following sections:

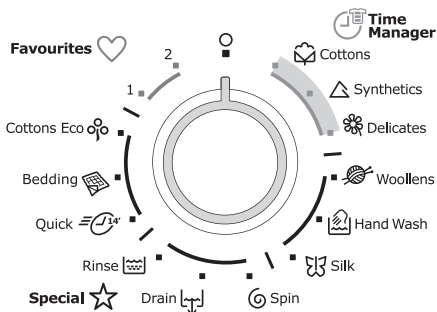

- Cottons , Synthetics , Delicates 
- Woollens , Hand Wash , Silk 
- Spin , Drain , Rinses 
- Cottons Eco , Bedding , Quick 
- Favourites programmes : **1, 2.**

The selector dial can be turned either clockwise or anticlockwise. Position **O** to Reset programme/ Switching OFF of the machine.

**At the end of the programme the selector dial must be turned to position O, to switch the machine off.**

### Attention!

If you turn the programme selector dial to another programme when the machine is working, on the display will appear the following message: **«Please turn programme selector in the last used position»**. The machine will not perform the new selected programme.

### Display

#### Note!

The DISPLAY is used for setting a large number of functions and combine them with each other using only a few control elements (1 programme selector dial and 8 buttons). This simple control method is made easy thanks to the interactive display. Interactive means that the washing machine display changes to reflect each step you have entered. This ensures that only those settings that make sense are made. You are able to see the current settings at any time in the information panel and in the option row.

The display shows the following information:

## Duration of the selected programme



After selecting a programme, the duration of the washing programme **(A)** and the estimated end of cycle **(B)** are displayed in hours and minutes (for example 2.05).

The duration is calculated automatically on the basis of the maximum recommended load for each type of fabric.

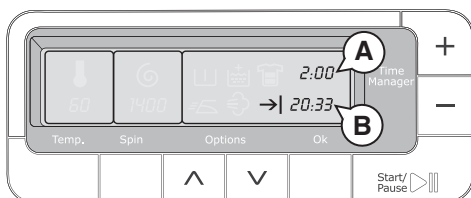

After the programme has started, the time remaining is updated every minute.

## Programme progress display

After you have pressed the Start/Pause button, the display of the machine shows which phase of the wash programme it's performing. On the display you can see the symbol of the selected type of fabric, the current phase, the duration of the wash programme and the end of cycle. When the machine performs the washing phase the display also shows some animated bubbles that simulate the moving of water.

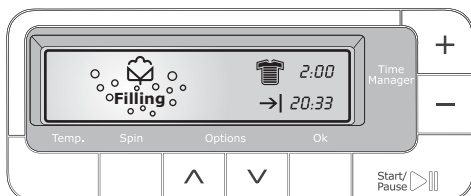

## Alarm codes

In the event of operating problems, some alarm codes can be displayed, for example **“Cannot fill water. Please check that the tab is open and then press START”** (please see paragraph “Something not working”).

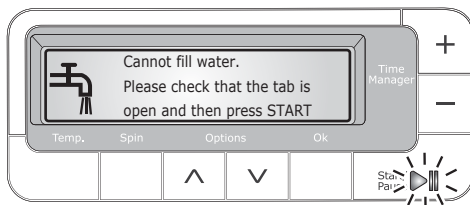

## End of programme

When the programme has finished the messages “Door Unlocked” and “Finished” appear alternatively. The door  remains on to inform that the wash cycle has finished and the door can be opened.

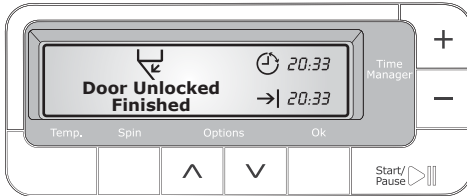

If your laundry is not removed during 10 minutes after the programme is finished, the backlight of the display switches off and the energy saving system will be enabled.

Only the Start/Pause button pilot light is flashing to indicate that the appliance has to be switched off.

By pressing any buttons the appliance will come out from the energy saving status and you could set another washing programme or switch off the appliance.

## Programme option button

Depending on the programme, different functions can be combined. These must be selected after choosing the desired programme and before depressing the Start/Pause button.

## Select the temperature

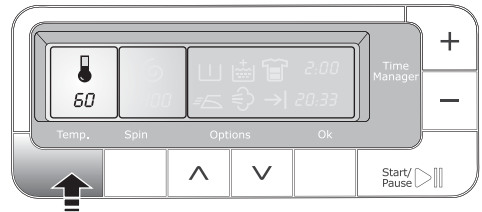

Press this button repeatedly to increase or decrease the temperature. If you want your laundry to be washed at a temperature different from the one proposed by the washing machine.

Maximum temperature are :

- 90°C for Cottons and Cottons Eco
- 60°C for Synthetics
- 40°C for Delicates, Wollens, Handwash and Bedding.
- 30°C for Silk and Quick
- \* corresponds to cold wash.

## Select the Spin speed or No spin or Night cycle or Rinse hold option











Press the Spin button repeatedly to change the spin speed, if you want your laundry to be spun at a speed different from the one proposed by the washing machine.

Maximum speeds are:

- for Cottons , Cotton Eco , Spin  and Rinse  : 1400 rpm;
- for Woollens , Handwash  : 1000 rpm;
- for Synthetics , Quick  : 900 rpm;
- for Delicates , Silk  Bedding  : 700 rpm;



### No Spin

No spin option eliminates all the spin phases and increase the number of rinses for Cottons , Synthetics , Delicates , Woollens , Hand Wash , Silk , Cottons Eco  and Quick .



### Night Cycle

By selecting this option, the machine will not drain the water of the last rinse, so as not to wrinkle the laundry.

As all spinning phases are suppressed. This washing cycle is very quiet, and can be selected at night or other appropriate times.

The rinse water level will increase on Cottons , Synthetics , Delicates  and Silk  programmes.

### To empty out the water:

- select the  (Drain),  (Spin) programme.
- reduce the spin speed if needed, by means of the relevant button
- depress Start/Pause button
- at the end of programme, on the display is shown the  (door) icon and the “Door Unlocked” message. The door can be opened.

### Rinse Hold

By selecting this option the water of the last rinse is not emptied out to prevent the fabric from creasing. When the programme has finished the display shows the icon of the selected programme and the message “Finished”, while on the right of the display the end cycle and the current time appear. The buzzer sounds a short jingle, the Start/Pause light is off and the door is locked to indicate that the water must be emptied out.



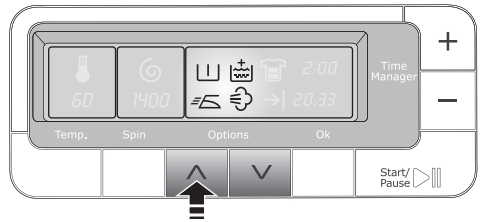

### Select the options



Depending on the selected programme only certain options are available and shown during the selection phase.

NOTE: Not all the options are compatible between themselves. The incompatible option icons will disappear.

The required options must be selected after having chosen the desired programme and before depressing the Start/Pause button.

By selecting the “Options”   buttons, you can activate the options menu. Using Up  or Down  button you can move through all the available options.

The display will show, using all the visible area, the selected option in highlighted mode. The corresponding icon will appear on the right side of the display and just

message describes the status of the option (Off or On).

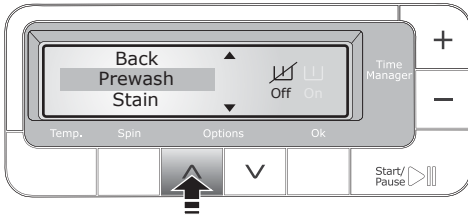



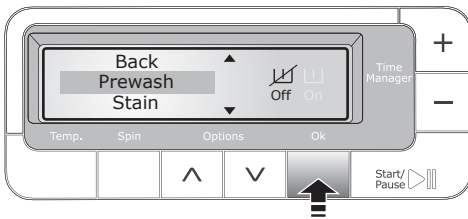

Press the **Ok** button to activate and confirm your choice, press it again to deactivate the selected option.

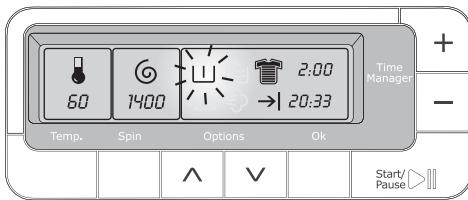

Once you have completed the selection of the options, press "Temp" or "Spin" Buttons or simply wait 10 seconds to return the display in the default status. The selected icons will be shown on the display.





### Prewash

Select this option if you wish your laundry to be pre-washed before the main wash (NOT available for Woollens , Hand wash , Silk , Quick  and Bedding ).

The Prewash ends with a short spin at 650 rpm in programmes for Cotton  and Synthetic  fabrics, whereas in the programme for Delicate  fabrics the water in only drain.





### Easy Iron

Selecting this option the laundry is gently washed and spun to avoid any creasing. In this way ironing is easier. Furthermore the machine will perform some additional rinses for Cottons  and synthetics .

This function can be used for Cottons , Synthetic  and Cottons Eco .

If this option is selected for cotton programme, the spin speed automatically will reduce to 900 rpm.



### Extra Rinse

this option can be selected with all programmes except for Woollens , Hand Wash , Silk , Quick  and Bedding  programmes. The machine perform some additional rinses.

The option is recommended for people who are allergic to detergents, and in areas where the water is very soft.

### Vapour

Select this option to add approximately 15-40 minutes of tumbling in vapour during the wash cycle. Vapour helps open fabric fibers up to allow laundry additives to release tough stains.

This function can be used for Cottons , Synthetics  and Cottons Eco  with temperature over 40°C

### NOTE:

- Vapour may not necessarily be visible inside the drum during a vapour wash cycle. Vapour is created below the drum and allowed to naturally rise into the clothes.
- Vapour may not be present during the entire vapour **wash cycle**.
- Vapour function is more effective with half load.

- At the end of the Vapour cycle the clothes will be warmer, softer and detached from the drum.



- If Vapour option is selected, rinse temperatures will be elevated.
- If washer is paused during a vapour wash cycle, the door will remain locked due to higher temperature in drum. DO NOT force the door open it will unlock when the washing machine has cooled.
- During a vapour cycle you may notice vapour exiting from the drain hose of the washing machine - this is normal and not cause for alarm.

### End Time (Delay Start)

This option makes it possible to delay the starting of the washing program by 30 min - 60 min - 90 min, 2 hours and then by 1 hour till 20 hours.

The delay you have selected is indicated on the display. The end time will increase in order to show you the selected delay.



You must select this option after you have set the programmes and before you press the Start/Pause button.

If you wish to add laundry in the machine during the delay time you will press Start /Pause button to put the machine in pause.

Add laundry , close the door and press Start/Pause button again.

You can cancel the delay time at any moment, before you press the Start/Pause button.

Selecting the delayed start.

- By pressing up  or Down  button you can move through the options menu till you locate “End Time”.
- Press Ok button to activate this option (the visualized time start to flash).

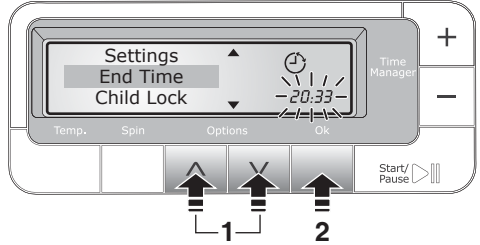

- By pressing Up  button you can increase the delay time.
- Press Ok button to confirm your delay.
- Press “Temp.” or “Spin” button to return the display to the default status.

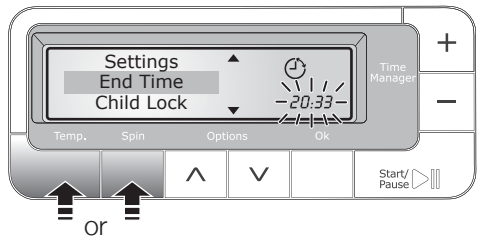

- Press the Start/Pause button to start the programmes will start after the selected delay has expired.

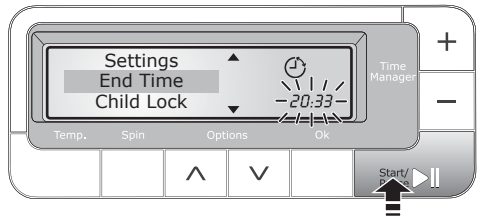

Canceling the delayed start

- Depress “Start/Pause” button to pause the appliance.

- By pressing Up **▲** or Down **▼** button you can move through the options menu till you located «End Time».
- Press Ok button to activate this option (the visualized time starts to flash).
- By pressing Down button you can decrease the «End Time» to the current time cancel completely the previous selected delay.
- Press Ok button to confirm your choice.
- Press «Temp.» or «Spin» button to return the display to the default status.
- Depress «Start/Pause» button to start immediately the programme.

## Child Lock

Your appliance is provided with CHILD SAFETY LOCK, which permits you to leave the appliance not supervised with the door closed without having the worry that children might be injured by or cause damage to the appliance.

Set this option before pressing the Start/Pause and after having selected the required programme wash.

This function remains enable also when the washing machine is not working.

Setting Child Lock option:

- press the «Options» **▲▼** buttons to activate the options mune.
- by pressing the Up **▲** or Down **▼** locate the child Lock option.

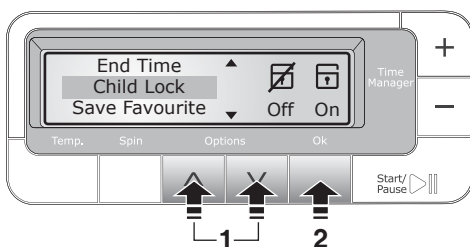

- press the Ok button to enable this option. The corresponding icon changes your status from Off to On and the following message appears on the display: «Press **▲** and **▼** buttons for 5 seconds to unlock machine».

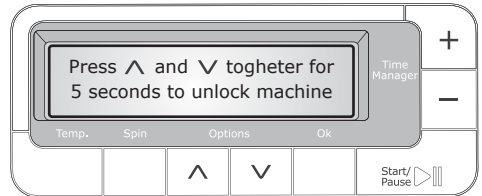

- by pressing «Temp.» or «Spin» button the display returns the default status.

If you press any key after the programme has started with «Child Lock» enabled, the display shows the message «Machine is locked, use key combination to unlock it».

The next time you wash the laundry, before selecting a new programme, it will be necessary to press simultaneously **▲** and **▼** buttons for 5 seconds until the display will show the message «Machine Unlocked».

## Favourite

Programme settings that are frequently used can be saved (e.g. Cotton, 60°C, 1200 rpm, with Prewash and Extra Rinse).

There are 2 memory spaces available for this purpose in the last 2 position of the programme selector dial. The saved programme can be selected in the same way as any other wash programme by means of the selector dial.

Saving Favourite programme:

- select the desired programme and required options
- press the “Options”  $\wedge \vee$  buttons to activate the options menu
- by pressing the Up  $\wedge$  or Down  $\vee$  locate the “Saving Favourite” option and depress Ok button
- by pressing  $\wedge$  or  $\vee$  select the number of “Favourite” (1-2) in which you wish memorize your customized programme.

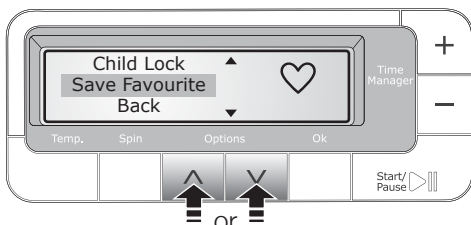

- press the Ok button to save the selected programme. On the display appears the message “Saved” in highlighted mode.

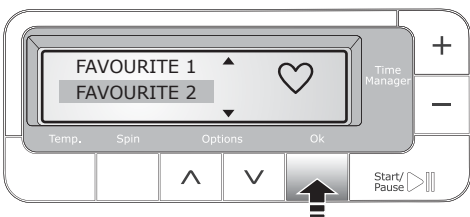

- by pressing “Temp.” or “Spin” button the display returns the default status.

To change the memorized programme setting repeat the procedure from the beginning.

### Note

If the memory space is already used by a programme previously selected, the display will show the message “Favourite already used”. Press Ok to overwrite it.

Press  $\vee$  and  $\wedge$  to cancel. Depress then “Ok” button to memorize the new programme.

The Favourites programme cannot be erased, but you can only overwrite them with another preferred washing programmes (see Note).

### Wash Guide

This appliance is provided for a wash guide menu that you allow to select the most suitable temperature, spin speed and options to wash your laundry.

In the Wash Guide menu you can also locate a Stain Guide, that contains important informations on how to remove the most representative stains, and a Demo Mode ideal for shop floor demonstrations (not suitable for the customer).

Selecting the Wash Guide:

- press the “Options”  $\wedge \vee$  button to activate the options menu
- by pressing the Up  $\wedge$  or Down  $\vee$  button you can locate the wash Guide option
- press the Ok button to enter into the Wash Guide menu

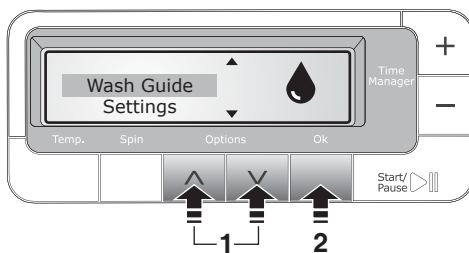

- by pressing the Up  $\wedge$  or Down  $\vee$  button you can move through the following list: Temperature Guide, Spin Speed Guide, Option Guide, Stain Guide and Demo Mode

- press the Ok button to enter into the selected help Guide and by pressing the Up  $\wedge$  or Down  $\vee$  you can read all the explanations of the selected one.

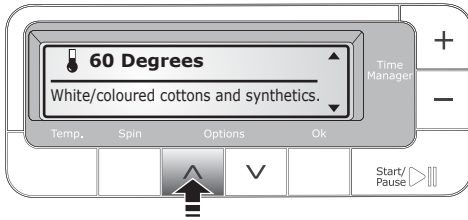
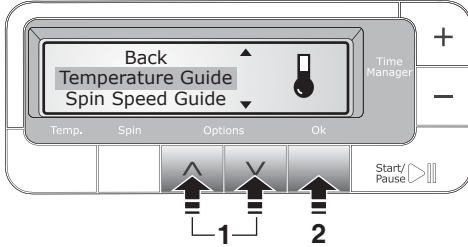

- to consult the informations of another Guide you must return to the Wash Guide menu selecting the “Back” symbol and repeat the procedure starting from the 4th point.

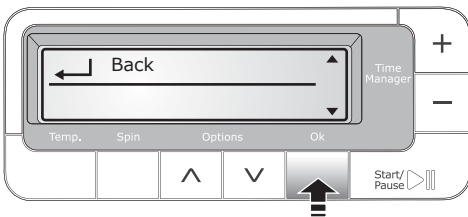

- by pressing “Temp.” or “Spin” button the display returns to the default status.



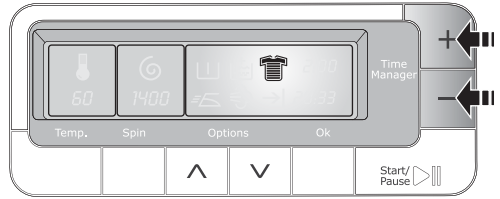





## Select the “Time Manager” option



This function allows you to modify the washing time, automatically proposed by the washing machine.

By pressing the “Time” manager button “+/-” repeatedly, the duration of the washing cycle can be increased or decreased.

The soil level icon  visualized on the display will change to indicate which type of soil degree you have chosen.

Soil Level	Icon	Type of fabric
Intensive		For heavy soiled items
Normal		For normal soiled items
Daily		For daily soiled items
Light		For slightly soiled items
Quick		For very slightly soiled items
Super Quick <sup>1)</sup>		For items used or worn for a short time
Refresh <sup>1)</sup>		For refreshing items only
Super Refresh <sup>1)</sup>		For refreshing a very few items only

1) We recommend you to reduce the load sizes (see Washing programmes table).

## Note

Once the programme has started, the “**Time Manager**” option cannot be changed.

## Select the Start/Pause



To start the selected programme, press the “**Start/Pause**” button; the corresponding green pilot light stops flashing.

On the display will appear the icon, and alternatively the name and the running phase of the selected programme to indicate that the appliance starts operating and the door is locked.

To interrupt a programme which is running, depress the “**Start/Pause**” button, the corresponding green pilot light starts to flash and the icon of the selected programme appears on the display to indicate that the appliance is “paused”.

To restart the programme from the point at which it was interrupted, press the “**Start/Pause**” button again.

if you have chosen a delayed start, the machine will begin the countdown.

## Altering an option or a running programme

It is possible to change any options visualised on the display by means of **^** and **v** buttons before the programme carries them out. Before you make any change, you must pause the washing machine by pressing the “**Start/Pause**” button.

Changing a running programme is possible only by resetting it. Turn the programme selector dial to “O” and then to the new programme position, press the “**Ok**” button to cancel the previous washing programme.

The washing water in the tub will not empty out.

## Interrupting a programme

Depress the “**Start/Pause**” button to interrupt a programme which is running, the corresponding light starts to flash. Depress the button again to restart the programme.

## Cancelling a programme

Turn the selector dial to “**O**” and then in the new selected programme. Press the “**Ok**” button to cancel the programme which is running. Now press the **Start/Pause** button to start the new programme.

## Opening the door after the programme has started



First set the machine to pause by pressing the “Start/Pause” button. The corresponding message will appear on the display.

If the door cannot be opened, this means that the machine is already heating, that the water level is above the bottom edge of the door or that the drum is turning. In this case the door can not be opened.

If you can not open the door but you need to open it you have to switch the machine off by turning the selector dial to “O”. After about 3 minutes the door can be opened (**pay attention to the water level and temperature!**).

## At the end of the programme

The machine stops automatically.

If the “Rinse Hold”  or Night Cycle  options have been selected, the “Start/Pause” light goes off, the icon of the selected programme and the message «Finished» appear on the display and the door remains locked to indicate that the water must be emptied out before opening the door.

**To empty out the water please read the steps on the “Night Cycle” option paragraph.**

Turn the programme selector dial to “O” to switch the machine off. Remove the laundry from the drum and carefully check that the drum is empty.

If you do not intend to carry out another wash, close the water tap. Leave the door open to prevent the formation of mildew and unpleasant smells.

## WASHING HINTS



### Sorting the laundry

Follow the wash code symbols on each garment label and the manufacturer's washing instructions. Sort the laundry as follows: whites, coloureds, synthetics, delicates, woollens.

### Temperatures

90°C	for normally soiled white cottons and linen (e.g. tea cloths, towels, tablecloths, sheets...).
50°C 60°C	for normally soiled, colourfast garments (e.g. shirts, night dresses, pyjamas....) in linen, cotton or synthetic fibres and for lightly soiled white cotton (e.g. underwear).
Cold 30°C 40°C	for delicate items (e.g. net curtains), mixed laundry including synthetic fibres and woollens bearing the label pure new wool, machine washable, non-shrink.

### Before loading the laundry

Never wash whites and coloureds together. Whites may lose their "whiteness" in the wash.

New coloured items may run in the first wash; they should therefore be washed separately the first time.

**Make sure that no metal objects are left in the laundry (e.g. hair clips, safety pins, pins).**

Button up pillowcases, close zip fasteners, hooks and poppers. Tie any belts or long tapes.

Remove persistent stains before washing.

Rub particularly soiled areas with a special detergent or detergent paste. Treat curtains with special care. Remove hooks or tie them up in a bag or net.

### Maximum loads

Recommended loads are indicated in the programme charts. General rules:

Cotton, linen:	drum full but not too tightly packed;
Synthetics:	drum no more than half full;
Delicate fabrics and woollens:	drum no more than one third full.

Washing a maximum load makes the most efficient use of water and energy. For heavily soiled laundry, reduce the load size.

## Laundry weights

The following weights are indicative:

bathrobe	1200 g
napkin	100 g
quilt cover	700 g
sheet	500 g
pillow case	200 g
tablecloth	250 g
towels	200 g
tea cloth	100 g
night dress	200 g
ladies' briefs	100 g
man's work shirt	600 g
man's shirt	200 g
man's pyjamas	500 g
blouse	100 g
men's underpants	100 g

## Removing stains

Stubborn stains may not be removed by just water and detergent. It is therefore advisable to treat them prior to washing.

**Blood:** treat fresh stains with cold water. For dried stains, soak overnight in water with a special detergent then rub in the soap and water.

**Oil based paint:** moisten with benzene stain remover, lay the garment on a soft cloth and dab the stain; treat several times.

**Dried grease stains:** moisten with turpentine, lay the garment on a soft surface and dab the stain with the fingertips and a cotton cloth.

**Rust:** oxalic acid dissolved in hot water or a rust removing product used cold. Be careful with rust stains which are not recent since the cellulose structure will already have been damaged and the fabric tends to hole.

**Mould stains:** treat with bleach, rinse well (whites and fast coloureds only).

**Grass:** soap lightly and treat with bleach (whites and fast coloureds only).

**Ball point pen and glue:** moisten with acetone (\*), lay the garment on a soft cloth and dab the stain.

**Lipstick:** moisten with acetone (\*) as above, then treat stains with methylated spirits. Remove any residual marks from white fabrics with bleach.

**Red wine:** soak in water and detergent, rinse and treat with acetic or citric acid, then rinse. Treat any residual marks with bleach.

**Ink:** depending on the type of ink, moisten the fabric first with acetone (\*), then with acetic acid; treat any residual marks on white fabrics with bleach and then rinse thoroughly.

**Tar stains:** first treat with stain remover, methylated spirits or benzene, then rub with detergent paste.

(\* *do not use acetone on artificial silk.*

## Detergents and additives

Good washing results also depend on the choice of detergent and use of the correct quantities to avoid waste and protect the environment. Although biodegradable, detergents contain substances which, in large quantities, can upset the delicate balance of nature.

The choice of detergent will depend on the type of fabric (delicates, woollens, cottons, etc.), the colour, washing temperature and degree of soiling.

Only low suds Front load washer detergents should be used in this appliance:

- powder detergents for all types of fabric.
- powder detergents for delicate fabrics (60 °C max) and woollens,
- liquid detergents, preferably for low temperature wash program (60 °C max) for all types of fabric, or special for woollens only.

The detergent and any additives must be placed in the appropriate compartments of the dispenser drawer before starting the wash program.

If using concentrated powder or liquid detergents, a program **without** prewash must be selected.

Pour liquid detergent into the dispenser drawer compartment marked  **just before** starting the program.

Any fabric softener or starching additives must be poured into the compartment marked  before starting the wash program.

Follow the product manufacturer's recommendations on quantities to use and **do not exceed the MAX mark in the detergent dispenser drawer.**

## Quantity of detergent to be used

The type and quantity of detergent will depend on the type of fabric, load size, degree of soiling and hardness of the water used.

Water hardness is classified in so-called "degrees" of hardness.

Information on hardness of the water in your area can be obtained from the relevant water supply company, or from your local authority.













Follow the product manufacturers' instructions on quantities to use.



Use less detergent if:





- you are washing a small load,
- the laundry is lightly soiled,
- large amounts of foam form during washing

**i** INTERNATIONAL WASH CODE SYMBOLS







These symbols appear on fabric labels, in order to help you choose the best way to treat your laundry.

<p><b>Energetic wash</b></p>   <p><b>Delicate wash</b></p>	 <p>Max. wash temperature 95 °C</p>	 <p>Max. wash temperature 60 °C</p> 	 <p>Max. wash temperature 40 °C</p>  	 <p>Max. wash temperature 30 °C</p> 	 <p>Hand wash</p>	 <p>Do not wash at all</p>
---	--	--	--	--	--	--















































 <p><b>Bleaching</b></p>	 <p>Bleach in cold water</p>	 <p>Do not bleach</p>
---	---	--



























 <p><b>Ironing</b></p>	 <p>Hot iron max 200 °C</p>	 <p>Warm iron max 150 °C</p>	 <p>Lukewarm iron max 110 °C</p>	 <p>Do not iron</p>
---	--	---	---	--

 <p><b>Dry cleaning</b></p>	 <p>Dry cleaning in all solvents</p>	 <p>Dry cleaning in perchlorethylene, petrol, pure alcohol, R 111 &amp; R 113</p>	 <p>Dry cleaning in petrol, pure alcohol and R 113</p>	 <p>Do not dry clean</p>
--	---	--	---	---

 <p><b>Drying</b></p>	 <p>Flat</p>	 <p>On the line</p>	 <p>On clothes hanger</p>	 <p>high temperature</p>  <p>low temperature</p> <p>Tumble dry</p>	 <p>Do not tumble dry</p>
--	---	--	--	--	--

## WASHING PROGRAMMES

Programme/ Temperature	Type of laundry	Description of programme	Options	Max. Load
 Cottons 90°-✱	White and coloured cotton: e.g. sheets, tablecloths, household linen, shirts, blouses, underwear.	Main wash from 90°C to ✱ (cold) Rinses Long spin	Spin Reduction /  /  /  /  /  /  /  /  /  (*) / Time Manager	8.0 kg
 Synthetics 60°-✱	Synthetic or mixed fabrics, underwear, coloured garments, non-shrink shirts, blouses.	Main wash from 60°C to ✱ (cold) Rinses Short spin	Spin Reduction /  /  /  /  /  /  /  /  /  (*) / Time Manager	4.5 kg
 Delicates 40°-✱	Delicate fabrics, for example curtains.	Main wash from 40° to ✱ (cold) Rinses Short spin	Spin Reduction /  /  /  /  /  /  /  / Time Manager	3.5 kg
 Woollens 40°-✱	Specially tested programme for wool garments bearing the “Pure new wool, non-shrink, machine washable” label.	Main wash from 40° to ✱ (cold) Rinses Short spin	Spin Reduction /  /  /  /  / 	2.0 kg
 Hand Wash 40°-✱	Special programme for hand washing fabrics.	Main wash from 40° to ✱ (cold) Rinses Short spin	Spin Reduction /  /  /  /  / 	2.0 kg
 Silk 30°- ✱	Silk items to be gentle washed and spun.	Main wash from 30°C to ✱ (cold) Rinses Short spin	Spin Reduction /  /  /  /  / 	1.0 kg

Programme/ Temperature	Type of laundry	Description of programme	Options	Max. Load
 Spin	Separate spin for cottons.	Drain and long spin	Spin Reduction / 	8.0 kg
 Drain	For emptying out the last rinse water in programmes with the Rinse Hold or Night Cycle option.	Draining of water	-	8.0 kg
 Rinses	Separate rinse cycle for cotton hand washed items.	Rinses Long spin	Spin Reduction /  /  /  /  /  / 	8.0 kg
 Quick 30°	Lightly soiled mixed fabrics	Main wash at 30° Rinses Short spin	Spin Reduction /  /  / 	4.5 kg
 Bedding 40°-30°	A gentle programme designed for mixed fabrics found in delicate cloths	Main wash from 40°C to 30° Rinses Short spin	Spin Reduction / 	8.0 kg
 Cottons Eco 90°-40°	White and coloured cotton economy, lightly-normally soiled items, shirts, blouses, underwear.	Main wash from 90°C to 40°C Rinses Long spin	Spin Reduction /  /  /  /  /  /  /  /  /  (*)	8.0 kg

(\*)  VAPOUR option is only available for wash temperatures over 40°C. To gain the full benefits of vapour feature, it is recommended a half load of each fabrics is used.

Cottons Eco programme with 60°C option selected is recommended for a full load of normally soiled cottons, and is the water and energy rating label programme (in accordance with AS/NZS 2040:2005 & AS/NZS 6400:2005).

## CARE AND CLEANING



You must **DISCONNECT** the appliance from the electricity supply, before you can carry out any cleaning or maintenance work.

### Descaling

The water we use normally contains lime. It is a good idea to periodically use a water softening powder in the machine. Do this separately from any laundry washing, and according to the softening powder manufacturer's instructions. This will help to prevent the formation of lime deposits.

### After each wash

Leave the door open for a while. This helps to prevent mould and stagnant smells forming inside the appliance. Keeping the door open after a wash will also help to preserve the door seal.

### Maintenance Wash

With the use of low temperature washes it is possible to get a build up of residues inside the drum. We recommend that a maintenance wash be performed on a regular basis.

To run a maintenance wash:

- The drum should be empty of laundry.
- Select the hottest cotton wash program.
- Use a normal measure of detergent, must be a powder with biological properties.

### External cleaning

Clean the exterior cabinet of the appliance with soap and water only, and then dry thoroughly.

### Cleaning the dispenser drawer

The washing powder and additive dispenser drawer should be cleaned regularly.

Remove the drawer by pressing the catch downwards and by pulling it out. Flush it out under a tap, to remove any traces of accumulated powder.

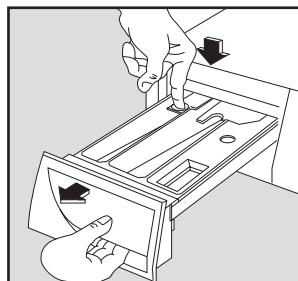

To aid cleaning, the top part of the additive compartment should be removed.

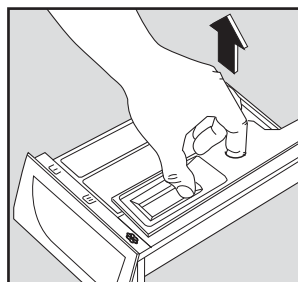

## Cleaning the drawer recess

Having removed the drawer, use a small brush to clean the recess, ensuring that all washing powder residue is removed from the upper and lower part of the recess.

Replace the drawer and run the rinse programme without any clothes in the drum.

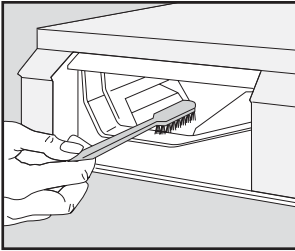

## Cleaning the pump

The pump should be inspected if

- the machine does not empty and/or spin
- the machine makes an unusual noise during draining due to objects such as safety pins, coins etc. blocking the pump.

Proceed as follows:

- Disconnect the appliance.
- If necessary wait until the water has cooled down.
- Open the pump door.

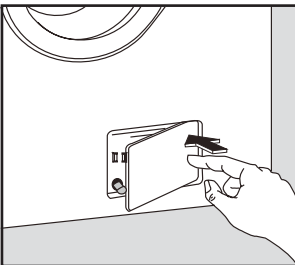

- Place a container close to the pump to collect any spillage.
- Pull out the emergency emptying hose, place it in the container and remove its cap.
- When no more water comes out, unscrew the pump cover and remove it. Always keep a rag nearby to dry up spillage of water when removing the cover.

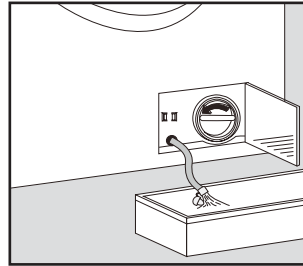

- Remove any objects from the pump impeller by rotating it.

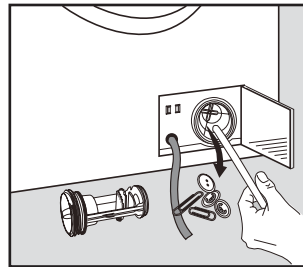

- Put the cap back on the emergency emptying hose and place the latter back in its seat.

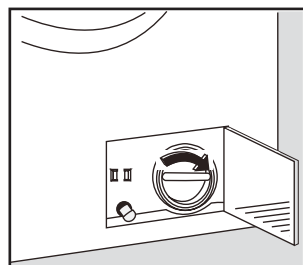

- Screw the pump cover fully in.
- Close the pump door.



### **Warning !**

When the appliance is in use and depending on the programme selected there can be hot water in the pump.

Never remove the pump cover during a wash cycle, always wait until the appliance has finished the cycle, and is empty. When replacing the cover, ensure it is securely retightened so as to stop leaks and young children being able to remove it.

### **Cleaning the water inlet filter**

If your water is very hard or contains traces of lime deposit, the water inlet filter may become clogged.

It is therefore a good idea to clean it from time to time.

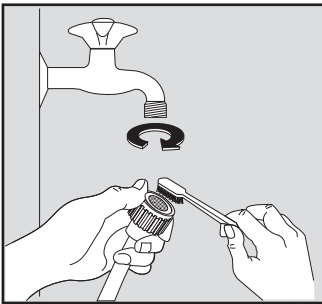

Turn off the water tap. Unscrew the water inlet hose. Clean the filter using a hard bristle brush. Tighten up the inlet hose.

### **The dangers of freezing**

If the machine is exposed to temperatures below 0°C, certain precautions should be taken.

- Turn off the water tap.
- Unscrew the inlet hose.
- Place the end of the emergency emptying hose and that of the inlet hose in a bowl placed on the floor and let water drain out.
- Screw the water inlet hose back on and reposition the emergency emptying hose after having put the cap on again.
- When you intend to start the machine up again, make sure that the room temperature is above 0°C.

### **Emergency emptying out**

If the water is not discharged, proceed as follows to empty out the machine:

- pull out the plug from the power socket;
- close the water tap;
- if necessary, wait until the water has cooled down;
- open the pump door;
- place a bowl on the floor and place the end of the emergency emptying hose into the bowl. Remove its cap. The water should drain by gravity into the bowl. When the bowl is full, put the cap back on the hose. Empty the bowl. Repeat the procedure until water stops flowing out;
- clean the pump if necessary as previously described;
- replace the emergency emptying hose in its seat after having plugged it;
- screw the pump cover again and close the door.

## TROUBLESHOOTING







Certain problems are due to lack of simple maintenance or oversights, which can be solved easily without calling out an engineer. Before contacting your local Service Centre, please carry out the checks listed below.

During machine operation it is possible that the **red** Start/Pause pilot light flashes, one of the following alarm codes appear on the display and the buzzer sounds a jingle for 5 minutes to indicate that the machine is not working:

- problem with the water supply:  
«Cannot fill water. Please that the tap is open and then press START»
- problem with water draining:  
«Cannot drain the water. Please check that the filter is clean and then press START»
- door open:  
«Please check that the door is closed properly and then press START».

Once the problem has been eliminated, press the **Start/Pause** button to restart the programme. If after all checks, the problem persists, contact your local Service Centre.

Malfunction	Possible cause	Solution
The washing machine does not start:	<ul style="list-style-type: none"> <li>● The door has not been closed. <b>(Please check that the door is closed properly and then press START).</b></li> <li>● The plug is not properly inserted in the power socket.</li> <li>● There is no power at the socket.</li> <li>● The main fuse has blown.</li> <li>● The selector dial is not correctly positioned and the Start/Pause button has not been depressed.</li> <li>● The delay start has been selected.</li> </ul>	<ul style="list-style-type: none"> <li>● Close the door firmly.</li> <li>● Insert the plug into the power socket.</li> <li>● Please check your domestic electrical installation.</li> <li>● Replace the fuse.</li> <li>● Please turn the selector dial and press the Start/Pause button again.</li> <li>● If the laundry are to be washed immediately, cancel the delay start.</li> </ul>
The machine fills then empties immediately:	<ul style="list-style-type: none"> <li>● The end of the drain hose is too low.</li> </ul>	<ul style="list-style-type: none"> <li>● Refer to relevant paragraph in “water drainage” section.</li> </ul>
On the display appears the message: <b>Anti-flooding system has been activated. Please check inlet/drain pipe connections.</b>	<ul style="list-style-type: none"> <li>● There is a water leakage from the connections</li> </ul>	<ul style="list-style-type: none"> <li>● Close the water tap, unplug the machine and call the Customer Service Centre.</li> </ul>

Malfunction	Possible cause	Solution
The machine does not fill:	<ul style="list-style-type: none"> <li>● The water tap is closed. <b>(Cannot fill water. Please check that the tap is open and then press START)</b></li> <li>● The inlet hose is squashed or kinked. <b>(Cannot fill water. Please check that the tap is open and then press START)</b></li> <li>● The filter in the inlet hose is blocked. <b>(Cannot fill water. Please check that the tap is open and then press START)</b></li> <li>● The door is not properly closed. <b>(Please check that the door is closed properly and then press START)</b></li> </ul>	<ul style="list-style-type: none"> <li>● Open the water tap.</li> <li>● Check the inlet hose connection.</li> <li>● Clean the water inlet hose filter.</li> <li>● Close the door firmly.</li> </ul>
The machine does not empty and/or does not spin:	<ul style="list-style-type: none"> <li>● The drain hose is squashed or kinked. <b>(Cannot drain the water. Please check that the filter is clean and then press START)</b></li> <li>● The drain pump is clogged. <b>(Cannot drain the water. Please check that the filter is clean and then press START)</b></li> <li>● The option ,  or  has been selected.</li> <li>● The laundry is not evenly distributed in the drum.</li> </ul>	<ul style="list-style-type: none"> <li>● Check the drain hose connection.</li> <li>● Clean the drain pump.</li> <li>● Disable the option ,  or .</li> <li>● Redistribute the laundry.</li> </ul>
There is water on the floor:	<ul style="list-style-type: none"> <li>● Too much detergent or unsuitable detergent (creates too much foam) has been used.</li> <li>● Check whether there are any leaks from one of the inlet hose fittings. It is not always easy to see this as the water runs down the hose; check to see if it is damp.</li> <li>● The drain hose is damaged.</li> <li>● The cap on the emergency emptying hose has not been replaced after cleaning the pump.</li> </ul>	<ul style="list-style-type: none"> <li>● Reduce the detergent quantity or use another brand.</li> <li>● Check the water inlet hose connection.</li> <li>● Change it with a new one.</li> <li>● Put the cap back on the emergency emptying and place the latter back in its seat.</li> </ul>

Malfunction	Possible cause	Solution
Unsatisfactory washing results:	<ul style="list-style-type: none"> <li>● Too little detergent or unsuitable detergent has been used.</li> <li>● Stubborn stains have not been treated prior to washing.</li> <li>● The correct temperature was not selected.</li> <li>● Excessive laundry load.</li> </ul>	<ul style="list-style-type: none"> <li>● Increase the detergent quantity or use another brand.</li> <li>● Use commercial products to treat the stubborn stains.</li> <li>● Check if you have selected the correct temperature.</li> <li>● Introduce into the drum less laundry.</li> </ul>
The door will not open:	<ul style="list-style-type: none"> <li>● The programme is still running.</li> <li>● The door lock has not been released.</li> <li>● There is water in the drum.</li> </ul>	<ul style="list-style-type: none"> <li>● Wait the end of washing cycle.</li> <li>● Wait for the Door icon  and the corresponding message appearing.</li> <li>● Select drain or spin programme to empty out the water.</li> </ul>
The machine vibrates or is noisy:	<ul style="list-style-type: none"> <li>● The transit bolts have not been removed.</li> <li>● The support feet have not been adjusted.</li> <li>● The laundry is not evenly distributed in the drum.</li> <li>● Maybe there is very little laundry in the drum.</li> </ul>	<ul style="list-style-type: none"> <li>● Check the correct installation of the appliance.</li> <li>● Check the correct levelling of the appliance.</li> <li>● Redistribute the laundry.</li> <li>● Load more laundry.</li> </ul>
The machine makes an unusual noise	<ul style="list-style-type: none"> <li>● The machine is fitted with a type of motor which makes an unusual noise compared with other traditional motors. This new motor ensures a softer start and more even distribution of the laundry in the drum when spinning, as well as increased stability of the machine.</li> </ul>	
No water is visible in the drum	<ul style="list-style-type: none"> <li>● Machines based on modern technology operate very economically using very little water without affecting performance.</li> </ul>	

Malfunction	Possible cause	Solution
Spinning starts late or the machine does not spin:	<ul style="list-style-type: none"> <li>• The electronic unbalance detection device has cut in because the laundry is not evenly distributed in the drum. The laundry is redistributed by reverse rotation of the drum. This may happen several times before the unbalance disappears and normal spinning can resume. If, after 10 minutes, the laundry is still not evenly distributed in the drum, the machine will not spin. In this case, redistribute the load manually and select the spin programme.</li> </ul>	<ul style="list-style-type: none"> <li>• Redistribute the laundry.</li> </ul>

If you are unable to identify or solve the problem, contact our service centre. Before telephoning, make a note of the model, serial number and purchase date of your machine: the Service Centre will require this information.

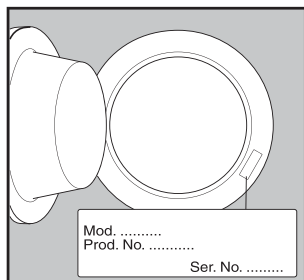

## TECHNICAL DATA

Dimensions	Width	60 cm
	Height	85 cm
	Depth	63 cm
Electrical connection Voltage - Overall power - Fuse	Information on the electrical connection is given on the rating plate on the inner edge of the appliance door	
Water supply pressure	Minimum	0.05 MPa
	Maximum	0.8 MPa
Maximum Load	Cottons	8.0 kg
	Synthetics	4.5 kg
	Delicates	3.5 kg
	Hand Wash	2.0 kg
	Silk	1.0 kg
Spin Speed	Maximum	1400 rpm



## INSTALLATION

### Unpacking



**All transit bolts and packing must be removed before using the appliance.**

You are advised to keep all transit devices so that they can be refitted if the machine ever has to be transported again.

- Using a spanner unscrew and remove the two rear bottom screws.

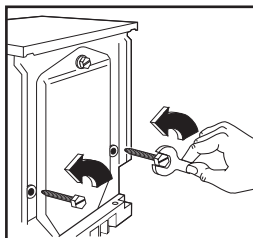

- Slide out the two plastic pins.

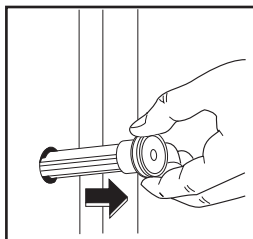

- Lay the machine on its back ensuring that the hoses are not crushed. Place one of the polystyrene angle packings under the machine.

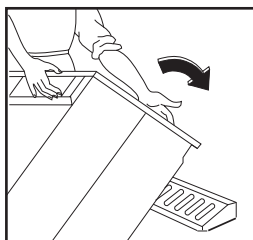

- Some models are provided with a bottom cover that will be found inside the washing machine drum. After ensuring the polyethylene bags have been removed, follow below instruction:

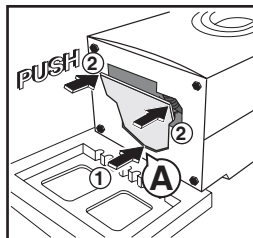

- Locate the bottom cover as shown in position (A).
- Then push the top end to lock the bottom of washing machine.

- Remove the polystyrene base, set the machine upright and unscrew the remaining rear screw. Slide out the relevant pin.

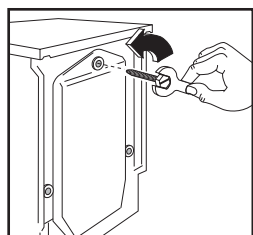

- Cover all the open holes with the plugs which you can find in the bag containing the instruction booklet.

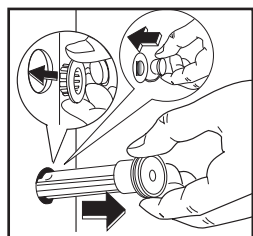

## Positioning

Install the machine on a flat hard floor. Make sure that air circulation around the machine is not impeded by carpets, rugs etc. Check that the machine does not touch the wall or cupboard units.

Carefully level by screwing the adjustable feet in or out.

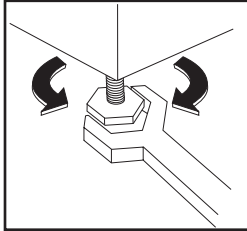

Never place cardboard, wood or similar materials under the machine to compensate for any unevenness in the floor.

## Water inlet

Connect the water inlet hose to a tap with 3/4" BSP thread.

Use the hose supplied with the washing machine. **DO NOT USE OLD HOSES.**

The other end of the inlet hose which connects to the machine can be turned in any direction.

Simply loosen the fitting, rotate the hose and retighten the fitting, making sure there are no water leaks.

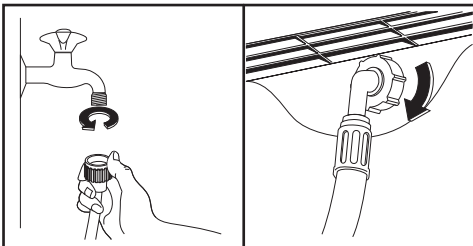

The inlet hose must not be lengthened. If it is too short and you do not wish to move the tap, you will have to purchase a new, longer hose specially designed for this type of use.

## Water drainage

The end of the drain hose can be positioned in three ways:

**Hooked over the edge of a sink using the plastic hose guide supplied with the machine.**

In this case, make sure the end cannot come unhooked when the machine is emptying.

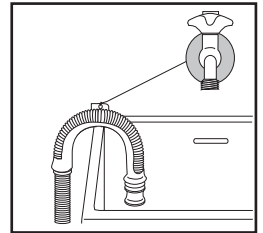

This could be done by tying it to the tap with a piece of string or attaching it to the wall.

**In a sink drain pipe branch.** This branch must be above the trap so that the bend is at least 60 cm above the ground.

**Directly into a drain pipe at a height** of not less than 60 cm and not more than 90 cm.

The end of the drain hose must always be ventilated, i.e. the inside diameter of the drain pipe must be larger than the outside diameter of the drain hose.

The drain hose must not be kinked. Run it along the floor; only the part near the drainage point must be raised.

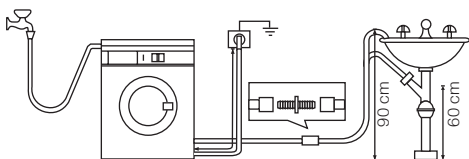

**For the correct functioning of the machine the drain hose must remain hooked on the proper support piece situated on the top part of back side of the appliance.**

## Electrical Connection

This machine is designed to operate on a 220-240 V, single-phase, 50 Hz supply.

**“An incorrect power supply may void your warranty.”**

Check that your domestic electrical installation can take the maximum load required (2.0 kW), also taking into account any other appliances in use.



**Connect the machine to an earthed socket.**

The manufacturer declines any responsibility for damage or injury through failure to comply with the above safety precaution. Should the appliance power supply cable need to be replaced, this should be carried out by our Service Centre.



### Important!

When the appliance is installed the power supply cable must be easily accessible. If this appliance is supplied from a cord extension set or electrical portable outlet device, the cord extension set or electrical portable device must be positioned so that it is not subject to splashing or ingress of moisture.

## ENVIRONMENT CONCERNS

### Packaging materials



The materials marked with the symbol  are recyclable.

>PE<=polyethylene

>PS<=polystyrene

>PP<=polypropylene

This means that they can be recycled by disposing of them properly in appropriate collection containers.

### Old machine

Use authorised disposal sites for your old appliance. Help to keep your country tidy!

The symbol  on the product or on its packaging indicates that this product may not be treated as household waste.

Instead it shall be handed over to the applicable collection point for the recycling of electrical and electronic equipment.

By ensuring this product is disposed of correctly, you will help prevent potential negative consequences for the environment and human health, which could otherwise be caused by inappropriate waste handling of this product.

For more detailed information about recycling of this product, please contact your local city office, your household waste disposal service or the shop where you purchased the product.

### Ecological hints

To save water, energy and to help protect the environment, we recommend that you follow these tips:

- Normally soiled laundry may be washed without prewashing in order to save detergent, water and time (the environment is protected too!).
- The machine works more economically if it is fully loaded.
- With adequate pre-treatment, stains and limited soiling can be removed; the laundry can then be washed at a lower temperature.
- Measure out detergent according to the water hardness, the degree of soiling and the quantity of laundry being washed.

# Electrolux Warranty

FOR SALES IN AUSTRALIA AND NEW ZEALAND  
APPLIANCE: WASHING MACHINE

**This document sets out the terms and conditions of the product warranties for Electrolux Appliances. It is an important document. Please keep it with your proof of purchase documents in a safe place for future reference should you require service for your Appliance.**

1. In this warranty
  - (a) 'Electrolux' means Electrolux Home Products Pty Ltd of 163 O'Riordan Street, Mascot, NSW 2020, ABN 51 004 762 341 in respect of Appliances purchased in Australia and Electrolux (NZ) Limited of 3-5 Niall Burgess Road, Mount Wellington, in respect of Appliances purchased in New Zealand;
  - (b) 'Appliance' means any Electrolux product purchased by you accompanied by this document;
  - (c) 'Warranty Period' means:
    - (i) where the Appliance is used for personal, domestic or household use (i.e. normal single family use) as set out in the instruction manual, the Appliance is warranted against manufacturing defects in Australia for 24 months and in New Zealand for 24 months, following the date of original purchase of the Appliance;
    - (ii) where the Appliance is used for commercial purposes (including being used to directly assist a business or where the Appliance is used in a multi-family communal or share type environment), the Appliance will then be warranted against manufacturing defects in Australia for 3 months and in New Zealand for 3 months, following the date of original purchase of the Appliance.
  - (d) 'you' means the purchaser of the Appliance not having purchased the Appliance for re-sale, and 'your' has a corresponding meaning.
  - (e) ASC means Electrolux' authorised serviced centres.
2. This warranty only applies to Appliances purchased and used in Australia or New Zealand and is in addition to (and does not exclude, restrict, or modify in any way) any non-excludable statutory warranties in Australia or New Zealand.
3. During the Warranty Period Electrolux or its ASC will, at no extra charge if your Appliance is readily accessible for service, without special equipment and subject to these terms and conditions, repair or replace any parts which it considers to be defective. Electrolux or its ASC may use remanufactured parts to repair your Appliance. You agree that any replaced Appliances or parts become the property of Electrolux. This warranty does not apply to light globes, batteries, filters or similar perishable parts.
4. Parts and Appliances not supplied by Electrolux are not covered by this warranty.
5. You will bear the cost of transportation, travel and delivery of the Appliance to and from Electrolux or its ASC. If you reside outside of the service area, you will bear the cost of:
  - (a) travel of an authorised representative;
  - (b) transportation and delivery of the Appliance to and from Electrolux or its ASC,

In all instances, unless the Appliance is transported by Electrolux or an Electrolux authorised representative, the Appliance is transported at the owner's cost and risk while in transit to and from Electrolux or its ASC.

6. Proof of purchase is required before you can make a claim under this warranty.
7. You may not make a claim under this warranty unless the defect claimed is due to faulty or defective parts or workmanship. Electrolux is not liable in the following situations (which are not exhaustive):
  - (a) the Appliance is damaged by:
    - (i) accident
    - (ii) misuse or abuse, including failure to properly maintain or service
    - (iii) normal wear and tear
    - (iv) power surges, electrical storm damage or incorrect power supply
    - (v) incomplete or improper installation
    - (vi) incorrect, improper or inappropriate operation
    - (vii) insect or vermin infestation
    - (viii) failure to comply with any additional instructions supplied with the Appliance;
  - (b) the Appliance is modified without authority from Electrolux in writing;
  - (c) the Appliance's serial number or warranty seal has been removed or defaced;
  - (d) the Appliance was serviced or repaired by anyone other than Electrolux, an authorised repairer or ASC.
8. This warranty, the contract to which it relates and the relationship between you and Electrolux are governed by the law applicable where the Appliance was purchased. Where the Appliance was purchased in New Zealand for business purposes the Consumer Guarantee Act does not apply.
9. To the extent permitted by law Electrolux excludes all warranties & liabilities other than as contained in this document.
10. For Appliances and services provided by Electrolux in Australia, the Appliances come with a guarantee by Electrolux that cannot be excluded under the Australian Consumer Law. You are entitled to a replacement or refund for a major failure and for compensation for any other reasonably foreseeable loss or damage. You are also entitled to have the Appliance repaired or replaced if the Appliance fails to be of acceptable quality and the failure does not amount to a major failure. The benefits to you given by this warranty are in addition to your other rights and remedies under a law in relation to the Appliances or services to which the warranty relates.
11. For Appliances and services provided by Electrolux in New Zealand, the Appliances come with a guarantee by Electrolux pursuant to the provisions of the Consumer Guarantees Act, the Sale of Goods Act and the Fair Trading Act.
12. To enquire about claiming under this warranty, please follow these steps:
  - (a) carefully check the operating instructions, user manual and the terms of this warranty;
  - (b) have the model and serial number of the Appliance available;
  - (c) have the proof of purchase (eg an invoice) available;
  - (d) telephone the numbers shown below.
13. You accept that if you make a warranty claim, Electrolux and its ASC may exchange information in relation to you to enable Electrolux to meet its obligations under this warranty.

### Important Notice

Before calling for service, please ensure that the steps listed in point 12 above have been followed.

<p><b>FOR SERVICE</b> or to find the address of your nearest state service centre in Australia <b>PLEASE CALL 13 13 49</b> <small>For the cost of a local call (Australia only)</small></p>	<p><b>SERVICE AUSTRALIA</b>  ELECTROLUX HOME PRODUCTS www.electrolux.com.au</p>	<p><b>FOR SPARE PARTS</b> or to find the address of your nearest state spare parts centre in Australia <b>PLEASE CALL 13 13 50</b> <small>For the cost of a local call (Australia only)</small></p>
<p><b>FOR SERVICE</b> or to find the address of your nearest authorised service centre in New Zealand <b>FREE CALL 0800 10 66 10</b> <small>(New Zealand only)</small></p>	<p><b>SERVICE NEW ZEALAND</b>  ELECTROLUX HOME PRODUCTS www.electrolux.co.nz</p>	<p><b>FOR SPARE PARTS</b> or to find the address of your nearest state spare parts centre in New Zealand <b>FREE CALL 0800 10 66 20</b> <small>(New Zealand only)</small></p>

**NOTE**

**NOTE**



[www.electrolux.com](http://www.electrolux.com)

