

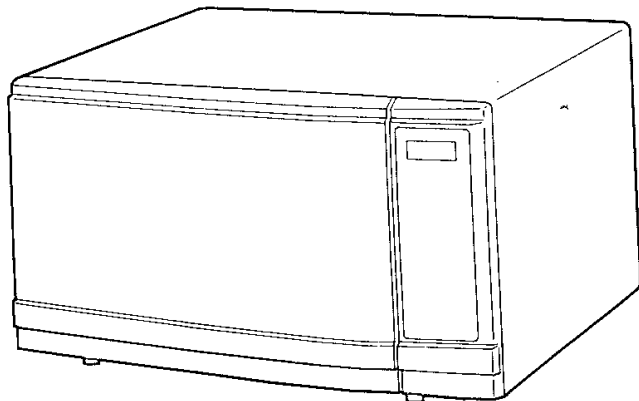

**USER'S GUIDE
AND COOKING GUIDE**

**Microwave Oven
Model JMC8100AD**



Read these instructions carefully before using your microwave oven.
Part no.8112p174-60 MCS p/n 74005590 A/08/00

SAVE THESE INSTRUCTIONS

PRECAUTIONS TO AVOID POSSIBLE EXPOSURE TO EXCESSIVE MICROWAVE ENERGY

- (a) **Do not** attempt to operate this oven with the door open since open-door operation can result in harmful exposure to microwave energy. It is important not to defeat or tamper with the safety interlocks.
- (b) **Do not** place any object between the oven front face and the door or allow soil or cleaner residue to accumulate on sealing surfaces.
- (c) **Do not** operate the oven if it is damaged. It is particularly important that the oven door close properly and that there is no damage to the:
 - (1) DOOR (bent)
 - (2) HINGES AND LATCHES (broken or loosened)
 - (3) DOOR SEALS AND SEALING SURFACES
- (d) **The oven** should not be adjusted or repaired by anyone except properly qualified service personnel.

SPECIFICATIONS

Model:	JMC8100ADB,W,Q	JMC8100ADS
Power Source:	AC 120 V, 60 Hz	AC 120 V, 60 Hz
Power Consumption:	1480W	1480W
Maximum Output:	1100W*	1100W*
Oven Capacity:	1.8 cu. ft.	1.8 cu. ft.
Turntable Diameter:	12- ⁵ / ₈ "	12- ⁵ / ₈ "
Dimensions: (w x h x d)	23- ⁷ / ₁₆ " x 14- ¹ / ₄ " x 17- ¹³ / ₁₆ "	23- ⁷ / ₁₆ " x 14- ¹ / ₄ " x 17- ¹³ / ₁₆ "
Weight: Approx.	41.5 lbs	42.5 lbs

Specifications subject to change without notice.

*According to IEC-705 test procedures. The IEC-705 test procedure is an internationally recognized method of rating microwave wattage output.

Please record your product's information

When you call to request service, you need to know your complete Model number and Serial number. Please fill in the information below. Please also record purchase date, price and where purchased. Keep your sales receipt and/or cancelled check as proof of purchase.

Model Number: _____ (Located on the inner left side of the control panel)

Serial Number: _____ (Located on the inner left side of the control panel)

Date of Purchase: _____

Where Purchased: _____

For additional questions, please contact us:

Maytag Appliance Sales Company
 Atten: CAIR® Center
 P.O.Box 2370
 Cleveland, TN 37320-2370
 1-800-688-1100(USA and CANADA)
 1-800-688-2080(U.S.TTY for deaf,
 hearing impaired or speech
 impaired)
 (Mon.-Fri., 8am-8pm Eastern Time)
 Internet: <http://www.maytag.com>

For service and warranty information, see pages 36-37.

IMPORTANT

Please keep your sales slip. Should any warranty service be required, proof of original date of purchase is needed.

NOTE

In our continuing effort to improve the quality of our appliances, it may be necessary to make changes to the appliance without revising this guide.

REGISTRATION

Federal law requires registration of all microwave ovens. To comply with the law, please fill out the PRODUCT

REGISTRATION CARD packed with the oven.

1. Check the model and serial numbers on the card to see that they match the numbers on the data plate. The data plate is located on the inner left side of control panel when the door is open. If the numbers on the card are not the same as those on the data plate, cross out the numbers on the card and write in the numbers as they appear on the data plate.
2. Mail the card. The return address is included on the reverse side of the card.

If you move or are not the original owner of this oven, you must by law renew the registration. Send the renewal registration information to:
Maytag Customer Service

Warranty Administration

P. O. Box 4970

Cleveland, TN 37320-4970

Renewal Registration information must provide:

- a) Your name and address.
- b) The microwave oven's model and serial numbers.

TABLE OF CONTENTS

SAFETY			
Important Safety Instructions	4	Defrost	19
Proper and Safe Use of Your Oven	5	Add 30 Seconds	20
Grounding Instructions	6	One Touch Start Cooking	21
Interference Note	7	Custom Programs	22
Utensils	7	COOKING GUIDE	
Materials	8	Cooking Principles and Techniques	23
SET UP		Auto Sensor Cooking Tips	24
Names of Oven Parts and Accessories	9	Sensor Cooking Recipes	26
Turntable Installation	9	Meats, Poultry and Fish	28
Installation	10	MAINTENANCE	
OPERATION		Troubleshooting	31
Control Panel and Features	11	Questions and Answers	33
Setting Clock	13	Care and Cleaning	34
Child Lock-Out	13	Warranty	36
Timer	14		
Timed Cooking and Power Level	14		
Auto Sensor Microwaving	16		
Auto Sensor Microwaving Tips	17		
Optional Settings	18		

SAFETY

SET UP

OPERATION

COOKING GUIDE

MAINTENANCE

IMPORTANT SAFETY INSTRUCTIONS

When using electrical appliances, basic safety precautions should be followed, including the following:



WARNING - To reduce the risk of burns, electric shock, fire, injury to persons or exposure to excessive microwave energy:

1. Read all instructions before using the appliance.
2. Read and follow the specific "PRECAUTIONS TO AVOID POSSIBLE EXPOSURE TO EXCESSIVE MICROWAVE ENERGY" on page 2.
3. As with most cooking appliances, close supervision is necessary to reduce the risk of a fire in the oven cavity.

If a fire should start:

 - Keep the oven door closed.
 - Turn the oven off.
 - Disconnect the power cord or shut off power at the fuse or circuit breaker panel.

Keep in mind the following rules at all times to reduce the risk of fire in the oven cavity:

 - a. Do not overcook food. Carefully attend the appliance if paper, plastic, or other combustible materials are placed inside the oven to facilitate cooking.
 - b. Do not use the oven cavity for storage purposes. Do not store combustible items such as bread, cookies, paper products, etc. inside the oven. If lightning strikes the power line, the oven may turn on by itself.
 - c. Remove wire twist-ties and metal handles from paper or plastic containers/bags before placing them in the oven.
4. This oven must be grounded. Connect only to properly grounded outlet. See "GROUNDING INSTRUCTIONS" on page 6.
5. Install or locate this oven only in accordance with the provided installation instructions.
6. Some products such as whole eggs, water with oil or fat, sealed containers and closed glass jars may explode and therefore should not be heated in this oven.
7. Use this appliance only for its intended use as described in the manual. Do not use corrosive chemicals or vapors in this appliance. This oven is specifically designed to heat, cook or defrost food. It is not designed for industrial or laboratory use. It is intended for home use.
8. As with any appliance, close supervision is necessary when used by children.
9. Do not operate this oven if it has a damaged cord or plug, if it is not working properly or if it has been damaged or dropped.
10. This appliance should be serviced only by qualified service technicians. Contact the nearest authorized service facility for examination, repair or adjustment.
11. Do not cover or block any vents on the oven.
12. Do not store or use this appliance outdoors.
13. Do not use this oven near water, near a kitchen sink, in a wet basement or near a swimming pool, and the like.
14. Do not immerse cord or plug in water.
15. Keep cord away from heated surfaces.
16. Do not let cord hang over edge of table or counter.

17. When cleaning door and oven surfaces that meet when door is closed, use only mild, nonabrasive soaps or detergents

applied with a sponge or soft cloth. (See "Cleaning" instructions on page 34.)

SAVE THESE INSTRUCTIONS

PROPER AND SAFE USE OF YOUR OVEN

- The oven must be level.
- The turntable and turntable roller rest must be in the oven during cooking.
- Place the cookware gently on the turntable and handle it carefully to avoid possible breakage.
- Incorrect use of browning dish may cause the turntable to break. See page 8.
- When using the Popcorn feature of this microwave oven, use only the bag sizes specified in the instruction manual.
- Do not pop popcorn except in a microwave approved popcorn popper or in a commercial package recommended especially for microwave ovens.
- The oven has several built-in safety switches to ensure that the power remains off when the door is open. Do not tamper with these switches.
- Do not operate the microwave oven empty. Operating the oven without any food or food that is extremely low in moisture can cause fire, charring or sparking.
- Do not cook bacon directly on the turntable. Excessive local heating of the turntable may cause it to break.
- Do not heat baby bottles or baby food in the microwave oven. Uneven heating may occur and could cause physical injury.
- Do not heat narrow-necked containers, such as syrup bottles.
- Do not attempt to deep-fry in your microwave oven.
- Do not do home canning in this microwave oven as it is impossible to be sure all contents of the jar have reached boiling temperature.
- Do not use this microwave oven for commercial purposes. This microwave oven is made for household use only.
- Liquids, such as beverages, that are heated in a microwave oven, can overheat beyond their boiling point without any evidence of bubbling. This could result in hot liquids suddenly boiling over. To prevent this occurrence, the following steps should be taken:
 - (a) Avoid using straight-sided containers with narrow necks.
 - (b) Do not overheat.
 - (c) Stir the liquid before placing the container in the oven and again halfway through the heating time.
 - (d) After heating, allow to stand in the oven for a short time, stirring again before carefully removing the container.

GROUNDING INSTRUCTIONS



DANGER Electric Shock Hazard

- Touching some of the internal components can cause serious personal injury or death. Do not disassemble this appliance.



WARNING Electric Shock Hazard

- Improper use of the grounding plug can result in electric shock. Do not plug into an outlet until appliance is properly installed and grounded.

Properly polarized and grounded outlet

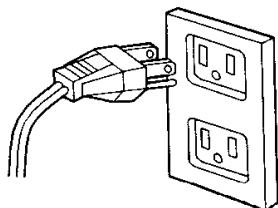

Three-pronged (grounding) plug

This appliance must be grounded. In the event of an electrical short circuit, grounding reduces the risk of electric shock by providing an escape wire for the electric current. This appliance is equipped with a cord that has a grounding wire with a grounding plug. The plug must be plugged into an outlet that is properly installed and grounded.

Where standard two-prong wall receptacle is encountered, it is your personal responsibility and obligation to have it replaced with a properly grounded three-prong wall receptacle.

Do not under any circumstance cut or remove the third (ground) prong from the power cord. Do not use an adapter plug with this appliance.

Consult a qualified electrician or serviceman if the grounding instructions are not completely understood or if doubt exists as to whether the appliance is properly grounded. If it is necessary to use an extension cord, use only a 3-wire extension cord that has a 3-pronged grounding plug, and a 3-slot receptacle that will accept the plug on the appliance.

- A short power-supply cord is provided to reduce the risks resulting from becoming entangled in or tripping over a longer cord.
- Longer cord sets or extension cords may be used if care is exercised in their use.
- If a long cord or extension cord is used: 1) The marked electrical rating of the cord set or extension cord should be at least as great as the electrical rating of the appliance. 2) The extension cord must be a grounding-type 3-wire cord, and 3) The longer cord should be arranged so that it will not drape over the counter top or tabletop where it can be pulled on by children or tripped over unintentionally.

NOTE: If your electric power line or outlet voltage is less than 110 volts, cooking times may be longer. Have a qualified electrician check your electrical system.

INTERFERENCE NOTE

Microwave ovens generate radio frequency energy during operation and if not installed properly may cause interference to radio and television reception. You can determine if this unit is causing interference by turning it on and off while the interference is occurring. If interference occurs, it may be corrected by one or more of the following measures:

- clean door and seal surfaces of the oven.
- reorient the television or radio receiving antenna.
- relocate the oven with respect to the television or radio receiver.
- plug the oven into a different outlet so that it, and the television or radio receiver, are on different circuits.

If the interference persists, you may want to consult an experienced radio/television technician for additional suggestions.

UTENSILS



CAUTION

Personal Injury Hazard

- Tightly-closed utensils could explode. Closed containers should be opened and plastic pouches pierced.

See following page for further instructions on "materials you can use in microwave oven or to be avoided in microwave oven." Do the test below to see if the utensil is safe for use in a microwave oven.

Utensil Test:

1. Fill a microwave-safe container with 1 cup of cold water (250 mL) along with the utensil in question.
2. Cook on **maximum** power (P100) for 1 minute.
3. Carefully feel the utensil.

If the empty utensil is warm, do not use it for microwave cooking.

Do not exceed 1 minute testing time.

CAUTION:

1. Do not use plastic containers for testing.
2. Some containers and dishware may be warm (or hot) in only one area. Do not use a container that becomes warm anywhere.

Materials you can use in microwave oven

Utensils	Remarks
Aluminum foil	Shielding only. Small smooth pieces can be used to cover thin parts of meat or poultry to prevent overcooking. Arcing can occur if foil is too close to oven walls. The foil should be at least 1 inch away from oven walls.
Browning dish	Follow manufacturer's instructions. The bottom of browning dish must be at least $\frac{3}{16}$ inch above the turntable. Incorrect usage may cause the turntable to break.
Dinnerware	Microwave-safe only. Follow manufacturer's instructions. Do not use cracked or chipped dishes.
Glass jars	Always remove lid. Use only to heat food until just warm. Most glass jars are not heat resistant and may break.
Glassware	Heat-resistant oven glassware only. Make sure there is no metallic trim. Do not use cracked or chipped dishes.
Oven cooking bags	Follow manufacturer's instructions. Do not close with metal tie. Make slits to allow steam to escape.
Paper plates and cups	Use for short-term cooking/warming only. Do not leave oven unattended while cooking.
Paper towels	Use to cover food for reheating and absorbing fat. Use with supervision for short-term cooking/warming only.
Parchment paper	Use as a cover to prevent spattering or a wrap for steaming.
Plastic	Microwave-safe only. Follow the manufacturer's instructions. Should be labeled "Microwave Safe." Some plastic containers soften as the food inside gets hot. If this happens, discard the food. "Boiling bags" and tightly closed plastic bags should be slit, pierced or vented as directed by package.
Plastic wrap	Microwave-safe only. Use to cover food during cooking to retain moisture. Do not allow plastic wrap to touch food.
Thermometers	Microwave-safe only (meat and candy thermometers).
Wax paper	Use as a cover to prevent spattering and to retain moisture.

Materials to be avoided in microwave oven

Utensils	Remarks
Aluminum tray	May cause arcing. Transfer food into microwave-safe dish.
Food carton with metal handle	May cause arcing. Transfer food into microwave-safe dish.
Metal or metal-trimmed utensils	Metal shields the food from microwave energy. Metal trim may cause arcing.
Metal twist ties	May cause arcing and could cause a fire in the oven.
Paper bags	May cause a fire in the oven.
Plastic foam cups	Plastic foam may melt or contaminate the liquid inside when exposed to high temperature.
Wood	Wood will dry out when used in the microwave oven and may split or crack.

SET UP

NAMES OF OVEN PARTS AND ACCESSORIES

Remove the oven and all materials from the carton.
Your oven comes with the following accessories:

Turntable	1
Turntable roller rest	1
Instruction Manual	1

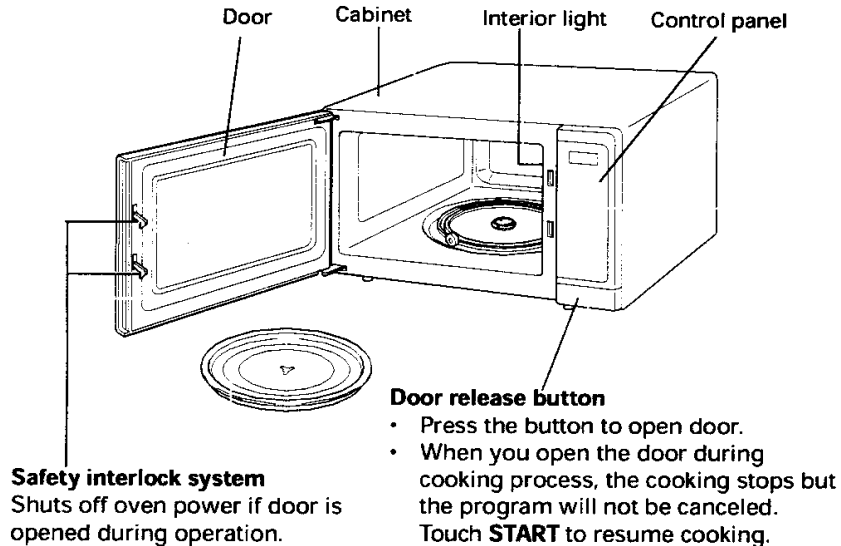

SET UP

TURNTABLE INSTALLATION

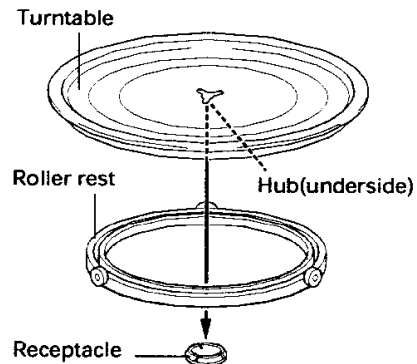

1. Place the roller rest on the cavity bottom.
 2. Place the turntable on top of the roller rest as shown in the diagram. Make sure the turntable hub is securely locked in the receptacle.
- **Never place the turntable upside down.** The turntable should never be restricted.

- Both turntable and roller rest must always be used during cooking.
- All food and containers of food are always placed on the turntable for cooking.
- **Turntable memory** allows the turntable to return to its starting position at the end of cooking operation. This is especially convenient for cups or other items with handles. At the end of cooking, "0" may remain in the display briefly to allow the turntable to return to its starting position. The oven light and fan will remain on but the microwave power is turned off.
- The turntable rotates clockwise and counterclockwise; this is normal.
- If turntable or roller rest cracks or breaks, contact your nearest authorized service center for more information regarding replacement.

INSTALLATION

Remove all packing material and accessories. Examine the oven for any damage such as dents or broken door. Do not install if oven is damaged.

NOTE: This unit is not designed for 50 Hz or any circuit other than a 120-volt/ 60-Hz AC circuit. This oven is designed for countertop installation.

Countertop Installation

1. Select a level surface that provides enough open space for the intake and/or outlet vents.

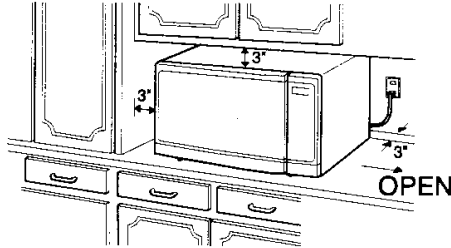

A minimum clearance of 3 inches is required between the oven and any adjacent wall. One side must be open.

- Leave a minimum clearance of 3 inches above the oven.
 - Do not remove the legs from the bottom of the oven.
 - Blocking the intake and/or outlet openings can damage the oven.
 - Place the oven as far away from radios and televisions as possible. Operation of microwave oven may cause interference to your radio or television. (See page 7.)
 - If the cabinet is covered with a protective film, remove the film.
2. Plug your oven into a standard 120-volt / 60-Hz household outlet. Be sure the electrical circuit is at least 15 amperes and that your microwave oven is the only appliance on the circuit.

Built-In Installation

It is necessary for you to purchase an Optional Kit for Built-in Installation. Contact the store where you purchased your oven for an optional Built-in Kit.

Model No.	Built-in Kit
JMC8100AD	(27 inch) JXA1027 (30 inch) JXA1030

- When installing in a Built-in situation, the oven requires an opening for installation.
(27 inch): 25-¹/₂" (w) x 16-¹/₁₆" (h) x 21" (d)
(30 inch): 28-³/₁₆" (w) x 16-¹/₁₆" (h) x 21" (d)
- Do not remove the legs from the bottom of the oven.
- Blocking the intake and/or outlet openings can damage the oven.
- Plug your oven into a standard 120-volt / 60-Hz household outlet. Be sure the electrical circuit is at least 15 amperes and that your microwave oven is the only appliance on the circuit.

WARNING: If installing the microwave oven over an electric oven, it must only be installed over the following Electric Ovens:
(27 inch) JJW8527, JJW9527 series
(30 inch) JJW8530, JJW9530 series
If installed over any other than the listed Electric ovens, the microwave could be damaged and the warranty would be void.

OPERATION

CONTROL PANEL AND FEATURES

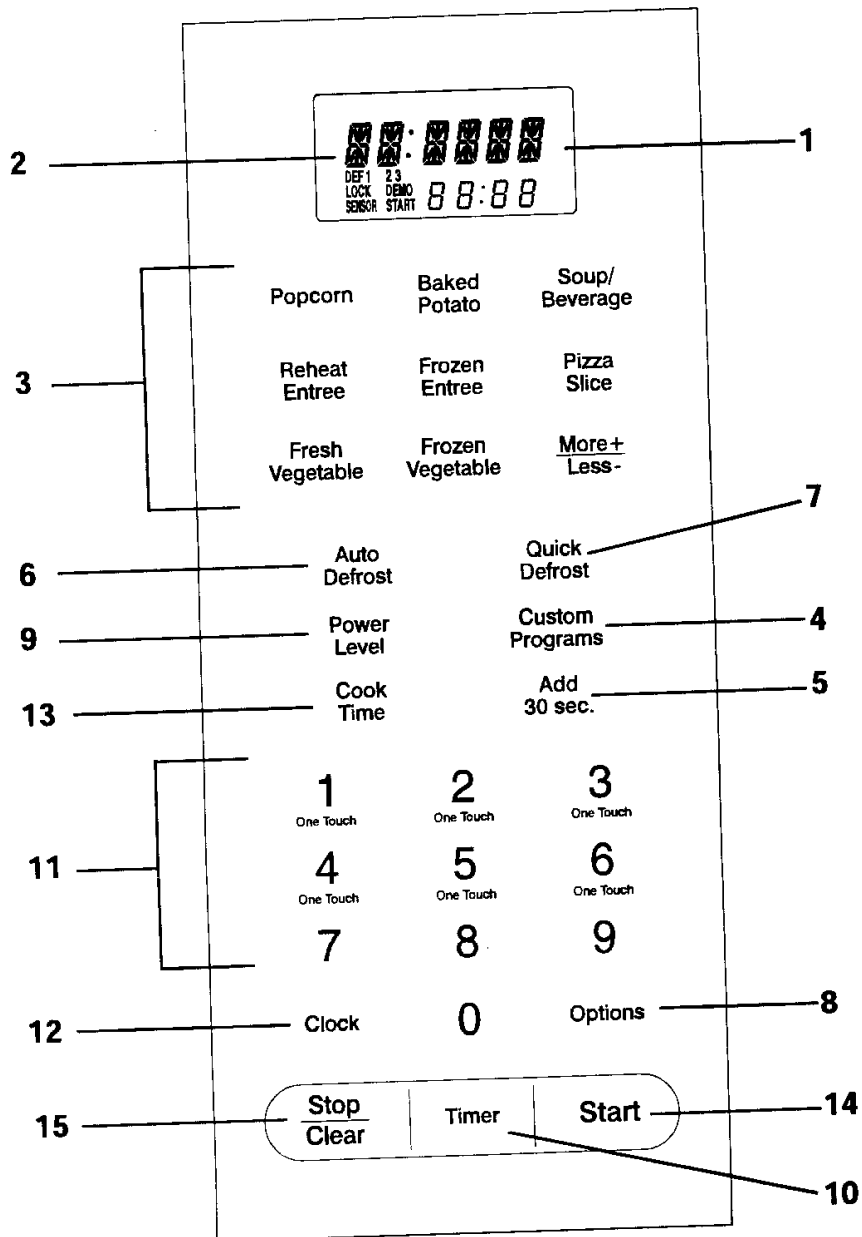

OPERATION





CONTROL PANEL AND FEATURES (CONT.)

- (1) **Display Window**
Upper line: Counts down cooking time in minutes and/or seconds. Shows clock time when oven is not in use. The word prompt scrolls to guide you when setting the clock and at every operation stage.
Lower line: Shows power level when using Timed Cooking. Shows Kitchen Timer time when this feature is selected.
- (2) **Indicators**
Indicators light or flash in the display window.
1/ 2/ 3: Lights to indicate current cooking stage.
DEF: Lights during Defrost.
LOCK: Lights to indicate the Child Lock-Out feature is set.
SENSOR: Flashes during Sensor cooking.
START: Flashes to prompt you to press START.
- (3) **Auto Sensor keypads** (Page 16)
Reheat Entree
Frozen Entree
Pizza Slice
Popcorn
Baked Potato
Fresh Vegetable
Frozen Vegetable
These Sensor keypads provide accurate and fast microwaving for a variety of popular foods with no guesswork.
Soup/Beverage
This selection requires entry of number of servings.
More+/Less-
Used to adjust cooking time for above menus.
- (4) **Custom Programs** (Page 22)
(5) **Add 30 sec.** (Page 20)
- (6) **Auto Defrost** (Page 19)
Provides thorough defrosting results.
- (7) **Quick Defrost** (Page 19)
Provides faster defrosting results. This option is excellent for thawing items such as ground meat for use in spaghetti sauce or for taco meat.
- (8) **Options** (Page 18)
Allows you to customize the following oven feature settings: word prompt on/off, clock on/off, beep on/off, word speed, language selection and weight selection.
- (9) **Power Level** (Page 14)
(10) **Timer** (Page 14)
(11) **Number keys**
Allows for the immediate start of one of 6 preset times from 1 to 6 minutes.
- (12) **Clock** (Page 13)
(13) **Cook Time** (Page 14)
(14) **Start**
- To start cooking.
 - To set and cancel child lock-out.
- (15) **Stop/Clear**
- Clears all previous settings if pressed before cooking starts. Press once to stop oven during cooking. Press twice to stop and clear all entries.
- Beep Sound**
A beep sounds when a keypad is pressed, to confirm your key entry.

SETTING CLOCK

To set the correct time of day, follow the steps below.

Example: To set 3:15:

Step	Procedure	Keypad
1	Press Clock .	
2	Press 3 , 1 and 5 to enter time of day.	  
3	Press Clock . The clock begins operation.	

- Note:**
- If the clock (or display) shows any abnormality, unplug the oven from the AC outlet. Plug it in again and then reset the clock.
 - When your oven is plugged in for the first time or after a power interruption, reset the clock.
 - This is a 12-hour clock.
 - You can use the oven without setting the clock.
 - The clock display can be turned off. See page 18 (Optional Settings) for more details.

CHILD LOCK-OUT

The oven has a safety feature which prevents use by children. This feature locks the operation of the oven until canceled.

To set:

Step	Procedure	Keypad
1	Press START and hold for 4 seconds. LOCK appears in the display.	

To cancel:

Step	Procedure	Keypad
1	Press START and hold for 4 seconds. LOCK disappears from the display.	

TIMER

You can set and use the Timer function independently, or while a cooking program is in progress. The Timer will be displayed on the lower line of the display. Timer can be set from 0 to 99 minutes 99 seconds.

Example: To set timer for 3 minutes:

Step	Procedure	Keypad
1	Press Timer .	
2	Press 3 , 0 and 0 to set 3 minutes.	
3	Press START . The timer starts counting and oven will beep for 7 seconds when time is up.	

- Note:**
- To clear a Timer setting, press **STOP/CLEAR**. If you are using both Timer and cooking, press **Timer**. Timer on the lower line of the display flashes for 5 seconds. Press **STOP/CLEAR** while Timer on the lower line of display flashes. The Timer will stop but the oven continues cooking to the end.
 - To stop beeps of Timer, touch **Timer**.
 - Timer will not beep if the oven beeps at the same time to indicate another oven operation (the end of a cooking, for example).
 - If you do not enter a time for 10 seconds after step 1, the setting is cleared with a beep.
 - If cooking completes while you are setting the Timer, all settings are cleared. Restart from step 1.
 - If no key is touched for 5 seconds after the last key entry at step 2 above, the timer automatically starts.

TIMED COOKING AND POWER LEVEL

This basic microwave cooking method allows you to cook food for a desired time. The oven can be programmed up to 99 minutes 99 seconds of cooking. In addition to the **P100** (maximum) power level, you can select different microwave power from 10 levels, **P0** to **P90** (0-90% of total power level).





Multi-stage Cooking:

You can program the oven for up to 3 stages of cooking in sequence. Each stage can be programmed with a different time setting and power level. To program 2-stage or 3-stage cooking, go through steps 1-3 on pages 15. Steps 1-3 should be followed for each stage of cooking that is programmed. After the time and power levels have been entered for all stages, press **START**. The oven will cook in accordance with the time and power sequences that were entered.

Delay Start Cooking:

You can delay the time that you would like the cooking to start. Cooking can be delayed up to 99 minutes and 99 seconds. To delay cooking, follow procedure for multi-stage cooking, but for stage 1 use power level **P0**.

Example: To cook at power level P80 for 40 seconds:

Step	Procedure	Keypad																								
1	Press Cook Time .																									
2	Enter 40 seconds by pressing 4 and 0 .	 																								
3	Press Power Level until P80 appears in the display. <table border="1" data-bbox="305 368 727 690"> <thead> <tr> <th>Power level</th> <th>Press</th> </tr> </thead> <tbody> <tr> <td>P100 (100%)</td> <td>once</td> </tr> <tr> <td>P90(90%)</td> <td>twice</td> </tr> <tr> <td>P80(80%)</td> <td>3 times</td> </tr> <tr> <td>P70(70%) Medium High</td> <td>4 times</td> </tr> <tr> <td>P60(60%)</td> <td>5 times</td> </tr> <tr> <td>P50(50%) Medium</td> <td>6 times</td> </tr> <tr> <td>P40(40%)</td> <td>7 times</td> </tr> <tr> <td>P30(30%) Med Low/Defrost</td> <td>8 times</td> </tr> <tr> <td>P20(20%)</td> <td>9 times</td> </tr> <tr> <td>P10(10%)</td> <td>10 times</td> </tr> <tr> <td>P 0 (0%)</td> <td>11 times</td> </tr> </tbody> </table>	Power level	Press	P100 (100%)	once	P90(90%)	twice	P80(80%)	3 times	P70(70%) Medium High	4 times	P60(60%)	5 times	P50(50%) Medium	6 times	P40(40%)	7 times	P30(30%) Med Low/Defrost	8 times	P20(20%)	9 times	P10(10%)	10 times	P 0 (0%)	11 times	
Power level	Press																									
P100 (100%)	once																									
P90(90%)	twice																									
P80(80%)	3 times																									
P70(70%) Medium High	4 times																									
P60(60%)	5 times																									
P50(50%) Medium	6 times																									
P40(40%)	7 times																									
P30(30%) Med Low/Defrost	8 times																									
P20(20%)	9 times																									
P10(10%)	10 times																									
P 0 (0%)	11 times																									
4	Press START .																									

OPERATION

- Note:**
- If no power level is entered, the power level will always be **P100** (100%).
 - Foods with high moisture content should be cooked on **P100** power.
 - To check the power level while Timer is operating, press **Power Level**.
 - To change power level during cooking, Press **Power Level**. Power level on the lower line of the display flashes for 3 seconds. During this time, press **Power Level** repeatedly until your desired power level appears.

POWER LEVEL SETTING GUIDE

P100	• Cooking poultry, vegetables, and most casseroles. • Boiling water. • Preheating a browning dish.	P50 Medium	• Cooking custards and pasta. • Cooking rump roast, ham, veal, lamb.
P90	• Reheating rice and pasta.	P40	• Cooking less tender cuts of meat in liquid or slow-cooking dishes. • Completing the cooking cycle of less tender roasts.
P80	• Reheating precooked or prepared food quickly. • Cooking fish.	P30 Med Low/ Defrost	• Completing the cooking cycle of casseroles, stews, sauces. • Time defrosting.
P70 Medium High	• Cooking cheese dishes.	P20	• Softening chocolate. • Clarifying butter. • Heating breads, rolls, pancakes, tacos, tortillas, French toast.
P60	• Cooking scrambled eggs. • Baking cakes.	P10	• Softening cream cheese, butter. • Keeping casseroles warm.

AUTO SENSOR MICROWAVING



The Auto Sensor feature uses a built-in humidity sensor that measures the amount of steam/humidity in the oven to accurately determine correct cooking time and power level for the food placed in the oven. A variety of popular foods have been preprogrammed. These foods are listed below in the REHEAT or COOK Food categories.

Press keypad to select your desired food type then press **START**.

Soup/Beverage selection requires entry of number of servings by pressing **Soup/Beverage** keypad until your desired setting appears on the display.

REHEAT Food Categories	COOK Food Categories
REHEAT ENTREE	POPCORN
FROZEN ENTREE	BAKED POTATO
SOUP/BEVERAGE	FRESH VEGETABLE
PIZZA SLICE	FROZEN VEGETABLE

Example - To reheat left over pizza:

Step	Procedure	Keypad
1	Press PIZZA SLICE .	
2	Press MORE/LESS once to increase cooking time; press twice to decrease time.	
3	Press START .	

- Note:**
- Do not open the oven door until time countdown starts in the display (after you pressed **START**).
 - Use the **POPCORN** keypad to pop prepackaged microwave-ready popcorn. Bag sizes: 1.75 oz to 3.5 oz only.

Reminder Beeps

About halfway through the Auto Sensor cooking process for **FRESH VEGETABLE** and **FROZEN VEGETABLE**, 5 beeps may sound to remind you to stir (turn or separate) longer cooking vegetables. If you do not open the door at the reminder beeps, the oven will continue to complete cooking.

MORE/LESS ADJUSTMENT

The **MORE/LESS** keypad allows fine adjustments in Auto Sensor Microwaving by either increasing or decreasing the preprogrammed cooking time.

To increase the time, press **MORE/LESS** once, and press **START**.

To decrease the time, press **MORE/LESS** twice, and press **START**.

If an Error Message appears...

ERROR 1: The door is opened before time countdown starts. Press **STOP/CLEAR**, and use Timed Cooking to finish. (Partially-cooked foods are no longer suitable for Auto Sensor Microwaving.)

ERROR 2: Auto Sensor Microwaving was attempted within 5 minutes after plugging in the oven. Press **STOP/CLEAR**, wait for 5 minutes and retry.

General Sensor Cooking/Reheating:

- For foods not listed in the Sensor Reheating/Cooking Guide (pages 24 - 25), use Timed Cooking.
- After **START** is pressed, do not open the door while the words **SENSOR COOKING** scroll across the display. During this time, the oven is measuring the amount of steam generated from the food. The oven then determines the heating or cooking time for the food.
- Room temperature should be below 35°C (95°F).
- Keep the inside of oven, the turntable and the outside of cooking containers dry. Wipe off all spillovers. Excessive humidity in the oven may result in an incorrect cooking time.
- Always cover food completely (but not too tightly) with wax paper, plastic wrap or casserole lids. Loose-fitting covers may cause the oven to miscalculate time. Never use tightly sealed plastic containers such as those with plastic snap closing lids.
- The following foods are not recommended: Boil-in-the-bag entrees or vegetables, raw or uncooked food, food that must be reheated uncovered, foods that should be crisp in texture after reheating, frozen cheesecake, dried foods, bread or pastry, beverages.
- Do not reheat in foil containers.
- When reheating 1 cup (250 mL) of delicate sauces/dips that contain sour cream, eggs or cream cheese, use Timed Cooking on power level P30 for 4 - 5 minutes and stir halfway through cooking time.

REHEAT ENTREE FROZEN ENTREE

- Auto Sensor Reheat is best used for 1 - 2 servings.
- Very dense foods (e.g. frozen lasagna) should be allowed to stand covered after reheating.

SOUP/BEVERAGE

- When reheating canned soups, remove from can. Add milk or water as directed on can. Place in a microwave-safe bowl or cup.
- Liquid must be room or refrigeration temperature.

POPCORN

- Use bag sizes 1.75 oz - 3.5 oz only.



See pages 24 - 27 for Auto Sensor Cooking Tips and Sensor Cooking Recipes.

OPTIONAL SETTINGS

The **Options** key allows you to customize oven feature settings as shown below:

Optional Features	Press Options pad	Press number pads to select
Word Prompt on/off The Word Prompt may be turned on or off*. *Prompt words may be shortened.	once	1-ON 2-OFF
Clock on/off The clock display can be turned off and back on.	twice	1-ON 2-OFF
Beep on/off The beep sound may be turned off and back on.	3 times	1-ON 2-OFF
Word Speed Setting The word speed can be changed to your preference.	4 times	1-HIGH 2-MEDIUM (default setting) 3-LOW
Language Selection You can select from English, Spanish or French for display.	5 times	1-ENGLISH (default setting) 2-ESPAÑOL 3-FRANÇAIS
Weight Selection The weight selection can be changed to your preference.	6 times	1-LB (default setting) 2-KG

Example: To select Spanish for Word Prompt display:

Step	Procedure	Keypad
1	Press the Options key 5 times until language choice prompt appears: 1-ENGLISH 2-ESPAÑOL 3-FRANÇAIS	
2	Press 2 to select Spanish.	

Note: When first plugged in, the oven will automatically display English in the Word Prompt display.

DEFROST



Defrost allows you to easily defrost food two ways. Power levels and times are automatically determined when the food weight is entered.

AUTO DEFROST: Use for more thorough defrosting of larger, dense frozen foods. Ideal for items such as roasts, whole chicken and steak.

QUICK DEFROST: Use to assist in the separation of frozen pieces of chicken, ground meats, or fish that need preparation prior to cooking.

Excellent for defrosting ground meat for use in spaghetti sauce or taco meat.

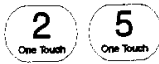
Example: To thoroughly defrost a 2.5 lb whole chicken:

Step	Procedure	Keypad																				
1	Press Auto Defrost .																					
2	Enter the weight of food. Weight must be converted to pounds and tenths (0.1) of a pound. Example: 2 lb. 8 oz. = 2.5 lbs Conversion Chart:																					
	<table border="1"> <thead> <tr> <th>Ounces</th> <th>Tenths of a Pound</th> </tr> </thead> <tbody> <tr><td>1 - 2</td><td>0.1</td></tr> <tr><td>3 - 4</td><td>0.2</td></tr> <tr><td>5</td><td>0.3</td></tr> <tr><td>6 - 7</td><td>0.4</td></tr> <tr><td>8</td><td>0.5</td></tr> <tr><td>9 - 10</td><td>0.6</td></tr> <tr><td>11 - 12</td><td>0.7</td></tr> <tr><td>13</td><td>0.8</td></tr> <tr><td>14 - 15</td><td>0.9</td></tr> </tbody> </table>	Ounces	Tenths of a Pound	1 - 2	0.1	3 - 4	0.2	5	0.3	6 - 7	0.4	8	0.5	9 - 10	0.6	11 - 12	0.7	13	0.8	14 - 15	0.9	
Ounces	Tenths of a Pound																					
1 - 2	0.1																					
3 - 4	0.2																					
5	0.3																					
6 - 7	0.4																					
8	0.5																					
9 - 10	0.6																					
11 - 12	0.7																					
13	0.8																					
14 - 15	0.9																					
3	Press START . Total defrost time appears in the display.																					

OPERATION

Defrosting Techniques:

- Remove freezer paper, plastic wrap or foil wrap. Place food in a microwave-safe dish.
- To prevent thin parts and edges from becoming too warm and cooking before center of food is defrosted, shield with small pieces of aluminum foil.
- Because some foods will still be icy in the center, it is necessary to have standing time after defrosting the food in the oven. Food should be taken out of the oven to complete defrosting. A longer standing time might be required for denser foods such as roasts.
- **Timed Defrosting:** Use power level **P30** (Medium Low). For most frozen foods, allow approximately 5 minutes per pound. To speed up the defrosting of dense foods over 1 lb, you may start on **P100 for 2 minutes**. Then reduce to the power level **P30** and enter remaining time.

- Note:**
- Maximum weight for defrosting is 5.9 lbs. If weight is entered at more than 5.9 lbs, a beep sounds to alert you to enter correct weight.
 - If **START** is pressed without entering a weight, the control will default to 1.0 lb.
 - Beep tone sounds 5 times during the defrosting cycle to signal that food should be rearranged to improve defrosting performance. After turning or rearranging, close door and press **START**. The oven continues the defrosting cycle to the end if you do not open the door.
 - Food should be removed from styrofoam packages before defrosting.

DEFROSTING CHART

Item	During Defrosting
Ground Meat (Beef, Poultry)	Turn over. Remove defrosted portions.
Steaks/Chops/Ribs/Roasts/Whole Chicken/Meat Pieces such as Chicken Pieces, Liver, Stew Meat, Bacon, Fish or Seafood	Turn over and rearrange. Shield warm or defrosted portions with small pieces of aluminum foil. Break apart pieces and remove any meat, poultry, or fish that is almost thawed. Some ice crystals should remain. Rinse chicken pieces, Cornish hens and fish fillets in cold water to separate after defrosting.

ADD 30 SECONDS

This feature provides 2 functions:

- Allows you to cook for only 30 seconds on P100 (maximum power).
- Allows you to extend a cooking time by 30 seconds without pressing **START**. You can repeat this option up to 3 times during Timed Cooking.

Example: To set 30-second cooking:

Step	Procedure	Keypad
1	Press Add 30 sec. once.	
2	Press START . The display shows time countdown.	

Note: This feature cannot be used during Auto Sensor Microwaving or Defrost by weight.

ONE TOUCH START COOKING

A time-saving feature, this simplified control lets you quickly start microwave cooking without pressing **START**.

Example: To set One Touch Start cooking for 2 minutes:

Step	Procedure	Keypad		
1	Press 2. The display shows time counting down.			
	<table border="1"> <thead> <tr> <th>Press</th> <th>Cooking time</th> </tr> </thead> <tbody> <tr> <td>1 - 6</td> <td>1 - 6 minutes</td> </tr> </tbody> </table>		Press	Cooking time
Press	Cooking time			
1 - 6	1 - 6 minutes			

Note: This feature only cooks at highest power level (P100). If this feature is not set within one minute of closing the door, the door must be opened and closed again.

ONE TOUCH START REHEATING AND COOKING CHART

Reheating	Amount	Time	Special Notes
Meat Chili, stews	2 cups	3 - 4 min.	Place in microwave-safe dish. Cover. Stir halfway through cooking time.
Hamburgers, meat loaf slices	1 serving 2 servings	1/2 - 1 min. 1 - 2 min.	Place on microwave-safe plate. Cover with paper towel. Turn over once.
Poultry Chicken pieces	2 4	1 - 2 min. 2 - 3 min.	Heat on microwave-safe plate. Cover with wax paper. If fried, cover with paper towel.
Chicken, turkey, sliced	3 - 5 oz	1 - 2 min.	Heat on microwave-safe plate. Cover with wax paper.
Seafood Shrimp, crab, or scallops in sauce, frozen	6 1/2 oz	3 - 5 min.	Pierce pouch and place on microwave-safe plate. Flex pouch to mix halfway through cooking time.
Cooked rice, pasta	1 cup (250 mL) 2 cups (500 mL)	1 - 2 min. 2 - 3 min.	Heat in microwave-safe casserole, covered with plastic wrap.
Canned vegetables	8 oz 15 oz	1 - 2 min 2 - 3 min.	Use microwave-safe casserole, covered. Stir once.
Cooking	Amount	Time	Special Notes
Mashed potatoes instant	4 servings	3 - 5 min.	Follow package directions. Reduce liquid by 1 tbsp (15 mL).
Pudding and pie filling mix	3 1/4 oz	4 - 6 min.	Follow package directions. Stir once.
Cereals Cream of Wheat (regular)	1/4 cup (50 mL)	1 - 2 min.	Add 3/4 cup (175 mL) of water. Cook uncovered. Stir once. Let stand for 1 minute.

OPERATION







CUSTOM PROGRAMS

For food or recipes prepared most often, you can easily customize a program using your own sequences or cooking stages (power levels/ cooking times). You can set 3 different custom programs (No. 1, No. 2 and No. 3). Each program may have 1 - 3 cooking stages.

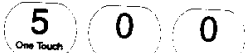

For example, you frequently cook 1 cup long-grain rice. For Stage 1 you use 100% power for 5 minutes to bring water to a boil. You then add rice, salt and butter and for Stage 2 you use 30% power for 20 minutes to cook rice. To set these 2 cooking sequences in the first Custom Program (No.1):

Stage 1 for 5 minutes at P100 (100% power)



Stage 2 for 20 minutes at P30 (30% power)

Step	Procedure	Keypad
1	Press Custom Programs once. No.1 appears in the display.	
2	Press Cook Time .	
3	Press 5, 0 and 0 to enter 5 minutes.	
4	Press Cook Time .	
5	Press 2, 0, 0 and 0 to enter 20 minutes.	
6	Press Power Level repeatedly until P30 appears in display.	
7	Press Custom Programs once. The Custom Program No.1 is now programmed into the microwave memory.	

To use a Custom Program:

Step	Procedure	Keypad
1	Once programming is completed, you can call up any of your Custom Programs (No. 1, No. 2 or No. 3) by pressing the Custom Programs keypad once, twice or 3 times.	
2	Press START .	

To delete a Custom Program:

Step	Procedure	Keypad
1	Call up the Custom Program (No. 1, No. 2 or No. 3) you want to delete by pressing Custom Programs .	
2	Press Cook Time .	
3	Press 0 and then Custom Programs .	

- Note:**
- For custom programming, only Timed Cooking can be used.
 - For more details, see page 14 for multi-stage cooking.

COOKING PRINCIPLES AND TECHNIQUES

The advantages of microwave cooking are speed and efficiency. For warming, heating, and defrosting, nothing compares. Here are a few tips that will make microwaving easier and more enjoyable.

Microwave Cooking Principles

Because microwave cooking requires only one-quarter to one-third the time of conventional cooking, cooking principles become even more important.

Quantity

In microwave cooking, the cooking time is dependent on the amount of food in the oven. If you double the recipe, plan on doubling the cooking time.

Density

Dense foods, such as potatoes, need more cooking time, as they take longer for microwave energy to penetrate and for the heat to be conducted through them.

Shape and Size

Cut food into uniform shapes and sizes for even cooking in the microwave. When cooking irregular shapes (such as chicken pieces), place the thicker parts to the outer edge of the dish.

Moisture, Sugar and Fat

Food high in moisture, sugar or fat cook faster. Add a minimum of liquid to moisten foods. Excessive amounts of water slow cooking.

Starting Temperature

Frozen or refrigerated foods take longer to microwave than food at room temperature.

Delicate Ingredients

Delicate foods such as eggs, cheese, mayonnaise, etc., cook very quickly, and should be watched carefully.

Microwave Cooking Techniques

Arranging: Arrange food in a circular pattern, with denser, thicker items at the edge of the dish.

Piercing: Pierce the membrane of foods such as eggs, oysters, snails, sausages, livers, clams and whole vegetables, so they do not burst. Pierce pouches when using cook-in-the-bag food items.

Reheating: Cooked food reheats extremely well by using a low level of microwave energy. Place denser foods near the outer edge of the dish when reheating.

Covering: Most foods will cook and reheat better when covered. Pierce plastic wrap to vent steam.

Stirring: Stir foods to help cook/reheat more quickly and evenly.

Turning Over: To promote even cooking, turn larger solid items such as roasts or baked potatoes over halfway through the cooking time.

Shielding: Use small, smooth strips of aluminum foil to prevent corners and thin or bony areas from overcooking.

Standing Time: Foods continue cooking even after removal from the oven. Standing time is necessary to allow foods to complete cooking/defrosting.

Converting Recipes

Microwave recipes will likely call for less liquid and cooking time.

Microwave Thermometers

A microwave-safe thermometer can be used to achieve the best results. Insert the thermometer carefully and properly into the food.

The guide below gives suggested thermometer readings for meat and poultry. Keep in mind that standing time is essential for most food to reach its proper temperature. Internal temperatures should be measured after 5-10 minutes of standing time.

Guide to Internal Temperatures

145°F (63°C)	. Rare beef
150°F (66°C)	. Vegetables, hot drinks, soups, casseroles
160°F (71°C)	. Medium beef, lamb, veal, pork
170°F (77°C)	. Well-done beef, lamb, pork
170°F (77°C)	. Whole fish
185°F (85°C)	. Well-done, poultry pieces or roasted bird

AUTO SENSOR COOKING TIPS

Reheating Guide

Item/Amount	Menu Course	Special Notes	
<p>Plate of food Pasta in sauce, turkey dinner, meatloaf dinner or similar types.</p> <p>Fully cooked, convenience foods</p> <p>4 oz.- 20 oz.</p>	REHEAT ENTREE	<p>Arrange less dense foods in the center of plate. Cover with plastic wrap. Allow to stand, covered, for a few minutes after reheating.</p> <p>Fully cooked, convenience foods that state they can be reheated in a microwave oven may be reheated using this program. Cover with plastic wrap. Allow to stand, covered, for a few minutes after reheating.</p> <p>Food should be covered with plastic wrap, film or a casserole lid. Stir food after reheating. Food that can not be stirred (ex. lasagna) should be allowed to stand covered for approximately 2-3 minutes after reheating.</p> <p>Cover with wax paper.</p>	
<p>Casserole Entree</p>		<p>Food should be covered with plastic wrap or film. Stir food after reheating. Food that can not be stirred (Ex. lasagna) should be allowed to stand covered for approximately 2-3 minutes after reheating. When reheating frozen plate of food, use LESS time adjustment for best results.</p> <p>Frozen convenience foods that state they can be reheated in a microwave oven may be reheated using this program. For better results, follow the suggestions below when reheating manufactured, frozen convenience foods.</p> <ul style="list-style-type: none"> • If there is a film that covers the tray, pierce the film approximately four times using a fork. You may also replace the film with microwave-safe plastic wrap and pierce the plastic wrap in the same manner. • Follow package instructions for suggested standing time, after cooking. Approximately 1-5 minutes. 	
<p>Fried chicken 2 - 4 pieces</p>		<p>Casserole Entree Lasagna, macaroni and cheese or other similar types. Turkey dinner, meatloaf dinner or similar types.</p> <p>4 oz. - 20 oz.</p>	<p>Cover soups with plastic wrap before heating. Stir soups after heating. When heating cream-type soups or thicker soups, use MORE time adjustment for best results. Use a microwave-safe bowl, dish, or mug.</p> <p>Beverages do not need to be covered before heating. Stir beverages after heating.</p>
<p>Casserole Entree Lasagna, macaroni and cheese or other similar types. Turkey dinner, meatloaf dinner or similar types.</p> <p>4 oz. - 20 oz.</p>		FROZEN ENTREE	
<p>Beverage Coffee, Tea 1- 3 servings (8 - 24 oz.)</p> <p>Soup 1-3 servings 1 serving (8 oz.)</p>	SOUP/ BEVERAGE		

AUTO SENSOR COOKING TIPS (CONT.)

Item/Amount	Menu Course	Special Notes
Pizza Slice 1-6 slices 1 slice (3 oz.)	PIZZA SLICE	Pizza should not be frozen. Place precooked pizza on a paper towel or paper plate. Do not cover. Place pizza point toward the center. CAUTION: Be careful when eating pizza heated in the microwave. The pizza surface and sauce can be very hot.

Cooking Guide

Item/Amount	Menu Course	Special Notes
Popcorn 1.75 oz. - 3.5 oz.	POPCORN	Follow package directions. 1) Bag should be at room temperature. 2) Do not use this feature, if popcorn bag size is other than 1.75 oz. - 3.5 oz. CAUTION: 1) After popping, open bag carefully. Popcorn and steam are extremely hot. 2) Do not reheat unpopped kernels or reuse bag. Overcooking can result in an oven fire. 3) Never use a brown paper bag for popping corn.
Baking potatoes White potatoes Sweet potatoes Whole: 1 - 6 potatoes 6 - 8 oz. each.	BAKED POTATO	Wash, scrub, and pierce potatoes in several places with a fork. Place on paper towels. Arrange potatoes in a circle, end-to-end. Avoid placing potatoes in the center of the turntable. Allow 5-10 minutes standing time.
Asparagus, broccoli, brussel sprouts, cauliflower, carrots, green beans, mushrooms, spinach 4 oz. - 2 lbs	FRESH VEGETABLE	Wash. Prepare and cut into slices, cubes, wedges, or julienne strips. Place vegetables in 1/2 quart to 2 quart microwave-safe casserole dish. Add 1 tablespoon of water for every 4 ounce serving. Cover dish with plastic wrap or casserole lid. Stir vegetables if Reminder Beeps sound. Let vegetables stand for approximately 2 minutes, or until vegetables are desired tenderness.
Broccoli, carrots, corn, cauliflower, green beans, peas, spinach, or a mixture of these. 4 oz. - 2 lbs	FROZEN VEGETABLE	Follow package instructions for the quantity of water to be added. Place vegetables in a 1/2 to 2 quart microwave-safe casserole dish. Cover dish with plastic wrap or casserole lid. Stir vegetables if Reminder Beeps sound. Follow package instructions for suggested standing time, or let stand approximately 3 minutes, or until vegetables are desired tenderness.

COOKING GUIDE

SENSOR COOKING RECIPES

BAKED POTATO RECIPE

Twice-Baked Potatoes

Cooking Time: About 14 - 17 minutes

- 4 baking potatoes (6 oz - 170 g each)
 - $\frac{1}{2}$ cup (125 mL) butter or margarine
 - $\frac{1}{2}$ cup (125 mL) dairy sour cream
 - $\frac{1}{2}$ tsp. (2 mL) salt
 - Dash pepper
 - Paprika
- 4 servings

Pierce potatoes with a fork several times. Place in oven end-to-end in a ring on a paper towel, spacing about 1 inch (2.5 cm) apart. Cook on **BAKED POTATO**. Remove from oven. Let stand several minutes. When potatoes can be handled, remove $\frac{1}{4}$ inch (0.6 cm) horizontal slice from top of each potato. Carefully scoop out pulp, keeping skins intact. Blend butter, sour cream, salt, and pepper into potato pulp. Beat vigorously until smooth. Spoon pulp mixture into potato shells, or pipe in with pastry bag and star tip. Place filled shells in a ring along edge of microwave-safe plate. Cook on P100, 2 to 4 minutes. Sprinkle with paprika.

FRESH VEGETABLE RECIPES

Asparagus with Orange-Balsamic Vinaigrette

Cooking Time: About 5 - 8 minutes

- 1 lb (450 g) asparagus, washed and trimmed
 - 2 tbsp. (30 mL) water
 - 2 tsp. (10 mL) finely grated orange peel
 - $\frac{1}{4}$ cup (50 mL) orange juice
 - 2 tbsp. (30 mL) olive oil or vegetable oil
 - 1 tbsp. (15 mL) balsamic or red wine vinegar
 - $\frac{1}{2}$ tsp. (2 mL) Dijon mustard
 - Salt and pepper to taste
- 4 servings

Trim asparagus so that stems will lie flat in microwave-safe dish. Add water. Cover with dish lid or plastic wrap. Place in oven. Cook on **FRESH VEGETABLE**. Stir vegetables if Reminder Beeps sound. When done, drain, cover and set aside. Meanwhile, combine orange peel, orange juice, oil, vinegar and mustard in a non-metallic dish. Pour over asparagus and toss lightly to coat asparagus. Cover, and cook on P100, 1 to 1 $\frac{1}{2}$ minutes or until heated through.

Carrot and Basil Bake

Cooking Time: About 5 - 8 minutes

- 1 lb (450 g) carrots, peeled and shredded
 - 1 small onion, minced
 - 2 tbsp. (30 mL) butter or margarine
 - 2 tbsp. (30 mL) water
 - 1 tsp. (5 mL) parsley flakes
 - $\frac{1}{2}$ tsp. (2 mL) basil
 - $\frac{1}{2}$ tsp. (2 mL) salt
- 6 servings

Combine all ingredients in 2 quart (2 litre) microwave-safe casserole. Cover with casserole lid. Cook on **FRESH VEGETABLE**. Stir vegetables if Reminder Beeps sound. Let stand 3 minutes before serving.

SENSOR COOKING RECIPES (CONT.)

FRESH VEGETABLE RECIPES

Creamy Cabbage

Cooking Time: About 8 - 11 minutes

- 1 lb (450 g) cabbage, shredded
 - $\frac{1}{4}$ cup (50 mL) water
 - 1 package (3 oz - 85 g) cream cheese, cut into cubes
 - 2 tbsp. (30 mL) milk
 - $\frac{1}{2}$ tsp. (2 mL) celery seed
 - $\frac{1}{2}$ tsp. (2 mL) salt
 - Dash pepper
 - Chopped parsley
- 5 - 6 servings

Place cabbage and water in 2 quart (2 litre) microwave-safe casserole. Cover with casserole lid. Place in oven. Cook on **FRESH VEGETABLE**. Stir vegetables if Reminder Beeps sound. Add remaining ingredients except parsley. Stir. Cover. Cook on P100, 4 to 5 minutes. Let stand 2 minutes. Stir and sprinkle with parsley before serving.

FROZEN VEGETABLE RECIPES

Neapolitan Green Beans

Cooking Time: About 7 - 10 minutes

- 1 package (10 oz - 280 g) frozen green beans
 - 2 tbsp. (30 mL) water
 - 1 small onion, thickly sliced
 - $\frac{1}{2}$ cup (125 mL) Italian dressing
 - 3 sliced bacon, cooked
- 3 - 4 servings

Place green beans and water in 1 $\frac{1}{2}$ quart (1 $\frac{1}{2}$ litre) microwave-safe casserole. Cover with casserole lid. Place in oven. Cook on **FROZEN VEGETABLE**. Stir vegetables if Reminder Beeps sound. Add onion and Italian dressing. Cover and cook on P100, 2 to 3 minutes, or until beans are tender and onion is transparent. Sprinkle with crumbled cooked bacon.

Cheesy Broccoli for Two

Cooking Time: About 5 - 8 minutes

- 1 package (10 oz - 280 g) frozen broccoli spears
 - 2 tbsp. (30 mL) water
 - $\frac{1}{4}$ cup (1 oz - 30 g) shredded Monterey jack cheese
- 2 servings

Place broccoli and water in shallow microwave-safe dish. Cover with plastic wrap. Place in oven. Cook on **FROZEN VEGETABLE**. Stir vegetables if Reminder Beeps sound. Sprinkle cheese over broccoli. Cook, uncovered, on P100, $\frac{1}{2}$ - 1 minute.

TIMED COOKING - MEATS, POULTRY AND FISH

PREPARATION

- Use a microwave-safe dish.
- Defrost frozen food completely.
- Wash poultry and fish in cool water.
- Arrange small items in a single layer in dish, avoid overlapping edges of food.
- Place thick sections toward edge of the dish.
- Use a rack in the dish to elevate meat out of the juices.
- Use spices and seasonings as desired.
- Add salt after cooking, if necessary.
- Aluminum foil can be used to cover thin parts of meat or poultry wings and legs to prevent overcooking.
- Foil should be applied toward the end of cooking time.
- Place meat fat side down to start cooking. Turn fat side up half way through cooking time.

COOKING

- Use wax paper or plastic wrap to stop spattering.
- Turn over or rearrange meat, poultry and fish halfway through cooking time.

CHECKING DONENESS

See page 23 for internal temperatures for desired doneness.

Beef: The color of the meat, on the inside, indicates doneness. Rare roast should be red inside. Medium is pink and gray indicates well done.

Pork: Cooked pork meat should be gray with clear juice.

Poultry: Juices should be clear yellow when cooked. Legs should move freely.

Fish and Seafood: Should be opaque in color and flake easily.

To check internal temperature of various meats and poultry, use a microwave or conventional meat thermometer after removing meat from the oven. Insert the thermometer, avoiding bone or fat. Lower temperatures are found in the center of the roast or in the muscle close to a large bone. **Never use a conventional meat thermometer in the microwave oven. (See pg. 23).**

Return undercooked food to oven for a short period of time at the recommended power level. Let stand as recommended in chart. Cover roasts and whole poultry during stand time.

Food	Power	Cooking Time	Standing Time	Special Notes	
Beef 4 oz each Hamburgers, refrigerated	2	P100	2 - 4 min.	Place in a shallow dish and cover loosely with wax paper. Turn over halfway through cooking.	
	4	P100	4 - 6 min.		
	Hamburgers, frozen	2	P100	4 - 6 min.	Defrost frozen patties just enough to easily separate. Turn over halfway through cooking.
		4	P100	7 - 9 min.	
Roasts, tender 1 lb	P50	10 - 13 min.	10 - 15 min.	Cover with wax paper. Shield halfway through cooking and turn roast over if necessary. Stand tented with foil.	

Food	Power	Cooking Time	Standing Time	Special Notes
Beef Meat loaf, 1½ lb	P50	15 - 20 min.	5 min.	Arrange in dish. Cover with wax paper.
Pork Chops, loin ½ inch thick, 7 oz each	1 P100 2 P100 4 P100	3 - 5 min. 6 - 8 min. 9 - 11 min.	2 min. 3 min. 3 min.	Place in a shallow dish. Cover loosely with wax paper. Turn over halfway through cooking.
Pork roast, 1 lb	P50	12 - 15 min.	10 - 15 min.	Cover with wax paper. Shield halfway through cooking and turn roast over if necessary. Approx. temp. after standing: 170°F (77°C)*
Ham, slice 1 inch thick, 1 lb	P100	7 - 9 min.	5 min.	Cover with wax paper. Turn over halfway through cooking.
Sausage links, Wieners, fresh 1 - 2 oz each	2 P100 4 P100	½ - 2 min. 1 - 3 min.	1 min. 1 min.	Score or pierce before cooking. Cover with wax paper. Turn over once.
Bacon, slices	2 P100 4 P100	1½ - 2 min. 2½ - 4 min.	1 min. 1 min.	Cook on bacon rack and cover with a paper towel, or place bacon between two sheets of paper towel on dish. Do not turn bacon over.
Lamb Chops, shoulder ½ inch thick	1 P100 2 P100	2 - 4 min. 4 - 6 min.	2 min. 5 min.	Cover loosely with wax paper.
Poultry Chickens, whole, up to 4 lb 1 lb Cornish hens 1 lb	P100 P100	6 - 9 min. 5 - 8 min.	10 min. 10 min.	Place breast-side down on a roasting rack in a dish. Cover with plastic wrap or wax paper. Turn over halfway through cooking. Stand tented with foil. When cooked, internal temperature of thigh should be 185°F (85°C) and juices should run clear.

*Check with conventional thermometer.

Food	Power	Cooking Time	Standing Time	Special Notes
Beef Meat loaf, 1½ lb	P50	15 - 20 min.	5 min.	Arrange in dish. Cover with wax paper.
Pork Chops, loin ½ inch thick, 7 oz each	1 P100 2 P100 4 P100	3 - 5 min. 6 - 8 min. 9 - 11 min.	2 min. 3 min. 3 min.	Place in a shallow dish. Cover loosely with wax paper. Turn over halfway through cooking.
Pork roast, 1 lb	P50	12 - 15 min.	10 - 15 min.	Cover with wax paper. Shield halfway through cooking and turn roast over if necessary. Approx. temp. after standing: 170°F (77°C)*
Ham, slice 1 inch thick, 1 lb	P100	7 - 9 min.	5 min.	Cover with wax paper. Turn over halfway through cooking.
Sausage links, Wieners, fresh 1 - 2 oz each	2 P100 4 P100	½ - 2 min. 1 - 3 min.	1 min. 1 min.	Score or pierce before cooking. Cover with wax paper. Turn over once.
Bacon, slices	2 P100 4 P100	1½ - 2 min. 2½ - 4 min.	1 min. 1 min.	Cook on bacon rack and cover with a paper towel, or place bacon between two sheets of paper towel on dish. Do not turn bacon over.
Lamb Chops, shoulder ½ inch thick	1 P100 2 P100	2 - 4 min. 4 - 6 min.	2 min. 5 min.	Cover loosely with wax paper.
Poultry Chickens, whole, up to 4 lb 1 lb Cornish hens 1 lb	P100 P100	6 - 9 min. 5 - 8 min.	10 min. 10 min.	Place breast-side down on a roasting rack in a dish. Cover with plastic wrap or wax paper. Turn over halfway through cooking. Stand tented with foil. When cooked, internal temperature of thigh should be 185°F (85°C) and juices should run clear.

*Check with conventional thermometer.

Food	Power	Cooking Time	Standing Time	Special Notes
Poultry Chicken pieces, up to 2 lb 1 lb	P100	5 - 8 min.	5 min.	Arrange skin-side up in a baking dish, with meatier portions towards edge of dish. Turn over and rearrange halfway through cooking. Cover with plastic wrap or lid.
Fish and Seafood Fish fillets, $\frac{3}{4}$ lb Fish steaks 2, 6 oz each Scallops 1 lb Shrimp, medium size, shelled and cleaned, 1 lb Whole fish, stuffed or unstuffed, $1\frac{1}{2}$ to $1\frac{3}{4}$ lb	P100 P50 P70 P70 P100	4 - 6 min. 6 - 9 min. 4 - 7 min. 4 - 7 min. 7 - 10 min.	3 min. 5 min. 3 min. 3 min. 5 min.	Arrange in a single layer in dish. Cover with wax paper. Rearrange or stir shrimp or scallops halfway through cooking.

MAINTENANCE

TROUBLESHOOTING

Check your problem by using the chart below and try the solutions for each problem. If the microwave oven still does not work properly, contact the nearest authorized service center.

TROUBLE	POSSIBLE CAUSE	POSSIBLE REMEDY
Oven will not start.	<ul style="list-style-type: none"> • Electrical cord for oven is not plugged in. • Door is open. • A fuse in your home may be blown. • The circuit breaker tripped. • Plug is not inserted into wall outlet properly. 	<ul style="list-style-type: none"> • Plug into the outlet. • Close the door and try again. • You did not press START. • Replace fuse or contact a qualified electrician. • Reset circuit breaker. • Fully insert the 3-prong plug into wall outlet.
Arcing or sparking.	<ul style="list-style-type: none"> • Materials to be avoided in microwave oven such as metal or foil are used. • The oven is operated when empty. • Spilled food remains in the cavity. 	<ul style="list-style-type: none"> • Check materials and utensils you can use in microwave oven. (page 8) • Do not operate with oven empty. • Clean cavity with wet towel.
Food is not cooked, defrosted enough or overcooked.	<ul style="list-style-type: none"> • Materials to be avoided in microwave oven are used. • Oven ventilation ports are restricted. • The cooking time or power level is not at recommended setting. • Food is not turned or stirred. 	<ul style="list-style-type: none"> • Use microwave-safe cookware only. (page 8) • Check to see that oven ventilation ports are not restricted. • Check the chart. (page 15) • Turn or stir food.
LOCK appears on display.	<ul style="list-style-type: none"> • The control is locked. 	<ul style="list-style-type: none"> • Press START and hold for 4 seconds to unlock control panel. (page 13)
The oven is not cooking even though the display shows time counting down.	<ul style="list-style-type: none"> • You may be using Timer. • The door is not securely closed. 	<ul style="list-style-type: none"> • Press STOP/CLEAR to cancel the Timer. • Open and close the door.
The turntable will not rotate.	<ul style="list-style-type: none"> • The turntable is not correctly in place. 	<ul style="list-style-type: none"> • Check that the turntable is correctly placed on the receptacle. See turntable installation on page 9.
You do not hear any tone when keypad is pressed or end-of-cooking sound.	<ul style="list-style-type: none"> • You have turned off beep sound. 	<ul style="list-style-type: none"> • Reset the setting to beep sound on. See the optional settings on page 18.

MAINTENANCE

TROUBLE	POSSIBLE CAUSE	POSSIBLE REMEDY
<p>ERROR (ERROR 1, 2) message appears in the display window.</p>	<ul style="list-style-type: none"> • ERROR 1: If door is opened before time countdown appears in the display. • ERROR 2: If the oven has not been plugged into a power supply for more than 5 minutes when you start Sensor Cooking. 	<ul style="list-style-type: none"> • Press STOP/CLEAR and restart using Timed Cooking on page 14. • Press STOP/CLEAR and wait for 5 minutes to restart from step 1 of Auto Sensor Microwaving on page 16.
<p>Why couldn't I get good results even though I cooked food using Auto Sensor Cooking?</p>	<ul style="list-style-type: none"> • The food was not covered properly. • STOP/CLEAR was pressed or the door was opened while the sensor was programming the right cooking time and power level. • The food being cooked was not suitable for Auto Sensor Microwaving. • There may have been too much or not enough food to ensure proper results from Auto Sensor Microwaving. 	<ul style="list-style-type: none"> • See pages 16 -17 and 24 - 25 for instructions on how to prepare food. • Do not open the door or press STOP/CLEAR while display shows SENSOR COOKING. • Use Timed Cooking. (see page 14) • When cooking more than 2 lbs (900 g) or less than 4 oz. (115 g) of food, use Timed Cooking on page 14.

QUESTIONS AND ANSWERS

- Q.** When the microwave oven is plugged into a wall outlet for the first time, it does not work properly. What is wrong?
- A.** The microcomputer used in the microwave oven control may temporarily become scrambled and fail to function as programmed. Unplug the oven from the wall outlet and then plug it back in again. The microcomputer should then automatically reset for proper functioning.
- Q.** Why is there noise coming from the turntable when the microwave oven is turned on?
- A.** This noise occurs when the turntable roller rest and cavity bottom are dirty. Clean the turntable roller rest and cavity bottom. Frequent cleaning of these parts should eliminate or reduce the noise.
- Q.** Why is there noise coming from the microwave oven when reducing power?
- A.** When cooking with a power other than P100, the oven cycles on and off to obtain the lower power level. The clicking noise can be heard when the oven cycles on and off. This is normal.
- Q.** Why is there steam coming out of the air exhaust vent?
- A.** Steam is produced during cooking. The microwave oven has been made to vent this steam out of the air exhaust vent.
- Q.** What is wrong when the microwave oven interior light will not glow?
- A.** There may be several reasons why the interior light will not glow. The light bulb may have burned out or **START** may not have been pressed. Replace the light bulb or press **START**. Never replace the light bulb by yourself. Contact an Authorized Service Center.
- Q.** Why do eggs sometimes pop?
- A.** The egg yolk may pop because of steam build-up inside the membrane. Pierce the membrane with a toothpick before cooking it. **Never microwave eggs in the shell since they may explode.**
- Q.** How are boil-overs avoided?
- A.** Use a larger utensil than usual for cooking or use a lower power level. If you open the microwave oven door or touch **STOP/CLEAR**, the food will stop boiling.
- Q.** Why does the beep tone sound when a pad on the control panel is pressed?
- A.** The beep tone sounds to assure that the setting is being properly entered. However, you can turn off the beep tone. See optional settings on page 18.

CARE AND CLEANING

Wipe the microwave oven inside and outside with a soft cloth and a mild detergent solution. Then rinse and wipe dry. This should be done on a weekly basis, more often if needed. Never use cleaning powders or rough pads. Excessive oil spatters on the top of the interior cavity will be difficult to remove if left for many days. Wipe spatters with a wet paper towel, especially after cooking chicken or bacon.

Stubborn soils: Boil a cup of water in the oven for 2 minutes. Steam will soften the soil. To get rid of odors inside the oven, boil a cup of water with some lemon juice in it.

REMOVABLE PARTS

The following parts may be removed as described. They should be washed in warm (not hot) water with a mild detergent and a soft cloth. Once they are clean, rinse them well and dry with a soft cloth. Never use cleaning powders, steel wool or rough pads.

- The turntable may be cleaned in the sink. Be careful not to chip or scratch the edges as this may cause the turntable to break during use. It may be washed in the dishwasher.
- The turntable roller rest should be cleaned regularly. It may be washed in the dishwasher.

SPECIAL CARE

For best performance and safety, the inner door panel and the oven front frame should be free of food or grease buildup. Clean them often with a mild detergent. Then rinse and wipe dry. Never use cleaning powders or abrasive pads.

STAINLESS STEEL/BRUSHED CHROME (SELECT MODELS):

- **DO NOT USE ANY CLEANING PRODUCT CONTAINING CHLORINE BLEACH.**
- **ALWAYS WIPE WITH THE GRAIN WHEN CLEANING.**
- **TO PREVENT SCRATCHING, DO NOT USE ABRASIVE OR CAUSTIC AGENTS.**
- **Daily Cleaning/Light Soil** -- Wipe with one of the following - soapy water, white vinegar/water solution, Formula 409 Glass and Surface Cleaner* or a similar multi-surface cleaner - using a sponge or soft cloth. Rinse and dry. To polish and help prevent fingerprints, follow with Stainless Steel Magic Spray (Part No.20000008).**
- **Moderate/Heavy Soil** -- Wipe with one of the following - Bon Ami or Soft Scrub* - using a damp sponge or soft cloth. Rinse and dry. To restore luster and remove streaks, follow with Stainless Steel Magic Spray.
- **Discoloration** -- Using a damp sponge or soft cloth, wipe with Cameo Stainless Steel Cleaner*. Rinse immediately and dry. To polish and help prevent fingerprints, follow with Stainless Steel Magic Spray.

After cleaning the control panel, press **STOP/CLEAR** to clear any entries that might have been entered accidentally while cleaning the panel.

The **CHILD LOCK - OUT** feature can be activated when cleaning the control panel. (See page 13.)

*Brand names and registered trademarks of the respective manufacturer.

**To order, call 1-800-688-8408.

MICROWAVE OVEN WARRANTY

Full Two Year Warranty

For two (2) years from the date of original retail purchase, any part which fails in normal home use will be repaired or replaced free of charge.

Limited Parts Warranty

After the second year from the date of original retail purchase through the fifth year, the following parts which fail in normal home use will be repaired or replaced free of charge for the part itself, with the owner paying all other costs, including labor, when the appliance is located in the United States or Canada: (1) Touch pad and microprocessor, (2) Magnetron tube, (3) High voltage transformer, (4) High voltage capacitor (5) High voltage rectifier.

Limited Parts Warranty Outside the United States or Canada

For one (1) year from the date of original retail purchase, any part which fails in normal home use will be repaired or replaced free of charge for the part itself, with the owner paying all other costs, including labor, when the appliance is located outside the United States or Canada.

Canadian Residents

This warranty covers only those appliances installed in Canada that have been listed with Canadian Standards Association unless the appliances are brought into Canada due to transfer of residence from the United States to Canada.

What is Not Covered by These Warranties

1. Conditions and damages resulting from any of the following:
 - a. Improper installation, delivery or maintenance.
 - b. Any repair, modification, alteration, or adjustment not authorized by the manufacturer or an authorized servicer.
 - c. Misuse, abuse, accidents or unreasonable use.
 - d. Incorrect electric current, voltage or supply.
 - e. Improper setting of any control.
2. Warranties are void if the original serial numbers have been removed, altered, or cannot be readily determined.
3. Light bulbs.
4. Products purchased for commercial or industrial use.
5. The cost of service or service call to:
 - a. Correct installation errors.
 - b. Instruct the user on the proper use of the product.
 - c. Transport the appliance to the servicer.
6. Consequential or incidental damages sustained by any person as a result of any breach of these warranties.

Some states do not allow the exclusion or limitation of consequential or incidental damages, so the above exclusion may not apply.

MICROWAVE OVEN WARRANTY(CONT.)

If You Need Service

- Call the dealer from whom your appliance was purchased or call Maytag Appliances Sales Company, Maytag Customer Assistance at 1-800-688-1100, USA and Canada or 1-423-472-3333 to locate an authorized servicer.
 - Be sure to retain proof of purchase to verify warranty status. Refer to WARRANTY (above) for further information on owner's responsibilities for warranty service.
 - If the dealer or service company cannot resolve the problem, write to Maytag Appliances Sales Company, Attn: CAIR® Center, P.O. Box 2370, Cleveland, TN 37320-2370, or call **1-800-688-1100** or **1-423-472-3333**. U.S. customers using TTY for deaf, hearing impaired or speech impaired, call 1-800-688-2080.
- NOTE: When writing or calling about a service problem, please include the following information:
- a. Your name, address and telephone number;
 - b. Model number and serial number;
 - c. Name and address of your dealer or servicer;
 - d. A clear description of the problem you are having;
 - e. Proof of purchase (sales receipt).
- User's guides, service manuals and parts catalogs are available from Maytag Appliances Sales Company, Maytag Customer Assistance.

MAINTENANCE