

YOUR
MONOGRAM
REFRIGERATOR
WITH
ELECTRONIC
MONITOR AND
DISPENSER.

BIS42CK
BISB42EK
BISB42EL
BISW42EK
BISW42EL

PUB 49-6551

MONOGRAM.



EFF DATE

10-2-87

49-6551

Contents

Appliance Registration 2
Care and Cleaning 16, 17
Condenser 16
Diagnostic Codes 8
Drawers 13
Drawer and Cover Removal 14
Electronic Monitor and Diagnostic System 5-8
 Door Alarm 6
 System Check—Reset 6, 7
 Warm Temperature 6
Energy Saver System 4
Energy-Saving Tips 2
Food Storage Suggestions 12
 Storage Times 12
Ice Dispenser 9-11
Icemaker 9-11
Installation 18
 Adapter Plug 18
 Adjustable Rollers 18
 Clearances 18
 Electrical Requirements 18
 Grounding 18
 Location 18
 Water Supply to Icemaker 18
Light Bulb Replacement 17
Model and Serial Numbers 2
Problem Solver 19-21
Quick Serve System 8
Repair Service 22
Safety Instructions 3
Shelves 15
Temperature Controls 5
Vacation Tips 17
Warranty Back Cover
Water Filter Accessory 11

Help us help you...

Read this book carefully.

It is intended to help you operate and maintain your new refrigerator properly.

Keep it handy for answers to your questions.

If you don't understand something or need more help, write (include your phone number):

Consumer Affairs
GE Appliances
Appliance Park
Louisville, KY 40225

Write down the model and serial number.

You'll see them on a label on the right side, near the bottom of the fresh food compartment.

These numbers are also on the Consumer Product Ownership Registration Card that came with your refrigerator.

Before sending in the registration card, please write these numbers here:

Model Number _____

Serial Number _____

Use these model and serial numbers in any correspondence or service calls concerning your refrigerator.

If you received a damaged refrigerator, immediately contact the dealer (or builder) that sold you the refrigerator.

Save time and money. Before you request service, check the Problem Solver on pages 19 through 21. It lists causes of minor operating problems that you can correct yourself.

Energy-saving tips

- Location of your refrigerator is important. Avoid locating it next to your range, a heating vent or where the sun will shine directly on it.
- Don't open the doors more often than necessary.
- Close the doors as soon as possible, particularly in hot, humid weather.
- Keep Energy Saver Switch in the OFF position unless moisture forms on the outside of the refrigerator.
- Be sure the doors are closed tightly. Before leaving the house or retiring for the night, check to be sure the doors haven't been left open accidentally.
- Store only those foods requiring refrigeration in your refrigerator.
- Wipe moisture from bottles and cartons before putting them in the refrigerator.
- Keep foods covered to reduce moisture buildup inside the refrigerator.
- If you turn the controls to the coldest position for quick chilling or freezing, be sure to turn them back to regular settings.
- Don't overcrowd your refrigerator. Overcrowding can require extra electrical energy to keep everything cool.



IMPORTANT SAFETY INSTRUCTIONS

Read all instructions before using this appliance.

WARNING—When using this appliance, always exercise basic safety precautions, including the following:

- Use this appliance only for its intended purpose as described in this Use and Care Book.
- This refrigerator must be properly installed in accordance with the Installation Instructions before it is used. See grounding instructions on page 18.
- Never unplug your refrigerator by pulling on the power cord. Always grip plug firmly and pull straight out from the outlet.
- Repair or replace immediately all electric service cords that have become frayed or otherwise damaged. Do not use a cord that shows cracks or abrasion damage along its length or at either the plug or connector end.
- After your refrigerator is in operation, do not touch the cold surfaces, particularly when hands are damp or wet. Skin may adhere to these extremely cold surfaces.
- Do not place fingers or hands on the automatic icemaking mechanism while the refrigerator is plugged in. This will help protect you from possible injury. It will also prevent interference with the moving parts of the ejector mechanism, or with the heating element that releases the cubes.

• Don't refreeze frozen foods which have thawed completely. The United States Department of Agriculture in Home and Garden Bulletin No. 69 says:

"...You may safely refreeze frozen foods that have thawed if they still contain ice crystals or if they are still cold—below 40°F.

"...Thawed ground meats, poultry or fish that have any off-odor or off-color should not be refrozen and should not be eaten. Thawed ice cream should be discarded. If the odor or color of any food is poor or questionable, get rid of it. The food may be dangerous to eat.

"Even partial thawing and refreezing reduce the eating quality of foods, particularly fruits, vegetables and prepared foods. The eating quality of red meats is affected less than that of many other foods. Use refrozen foods as soon as possible to save as much of their eating quality as you can."

• If your old refrigerator is still around the house but not in use, be sure to remove the doors. This will reduce the possibility of danger to children.

• Disconnect power to your refrigerator:

A. Before making any repairs.

Note: We strongly recommend that any servicing be performed by a qualified individual.

B. Before cleaning.

C. Before replacing a burned-out light bulb, power to the refrigerator should be disconnected at the fuse box or circuit breaker in order to avoid contact with a live wire filament. (A burned-out light bulb may break when being replaced.)

Note: Turning freezer compartment temperature control to OFF position does not remove power to the light circuit.

• Do not operate your refrigerator in the presence of explosive fumes.

SAVE THESE INSTRUCTIONS

Operating Your Refrigerator

Set Temperature Controls

Your refrigerator has two up-front controls that let you regulate the temperature in the fresh food and freezer compartments.

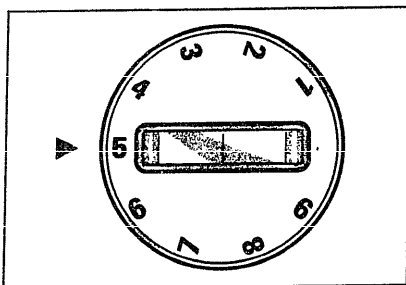

One control, with settings from 1 through 9, is located at the upper left in the fresh food compartment.

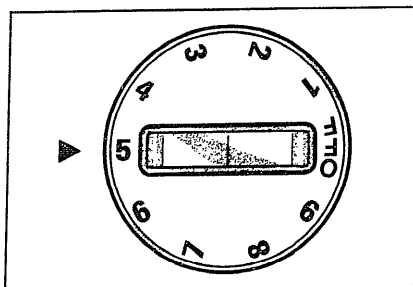

The other control, with settings from 1 through 9 plus OFF, is located at the upper right near the top of the freezer compartment. 9 is the coldest setting, 1 is the warmest.

INITIALLY, SET BOTH CONTROLS AT 5.

For colder or warmer temperatures, adjust the desired compartment control one number at a time.

IMPORTANT: When initially setting controls, or adjusting them, allow 24 hours for temperatures to stabilize.

Note: Turning the freezer control to the OFF position stops cooling in BOTH compartments—fresh food AND freezer—but does not shut off power to the refrigerator.

How to Test Temperatures

Use the milk test for the fresh food compartment. Place a container of milk on the top shelf in the fresh food compartment. Check it a day later. If the milk is too warm or too cold, adjust the temperature controls.

Use the ice cream test for the freezer compartment. Place a container of ice cream in the center of the freezer compartment. Check it after a day. If it's too hard or too soft, adjust the temperature controls.

Always allow 24 hours for the refrigerator to reach the temperature you set.

Energy Saver Switch

The Energy Saver Switch is located across from the fresh food temperature control.

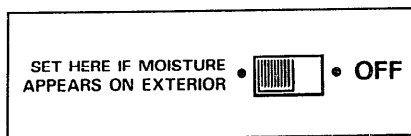

To reduce the amount of electricity required to operate your refrigerator, push switch to the OFF position.

This turns off heaters in your refrigerator that prevent moisture from forming on the outside.

With the heaters turned off, there is a chance that moisture may form on the outside of your refrigerator, especially when the weather is humid. The humidity is most likely to be high in the summer, in the early morning hours, and in homes which are not air conditioned.

Over an extended period of time, moisture that forms on the outside may cause deterioration of the paint finish. It will be important to protect the finish by using appliance polish wax as described on page 16.



When the Energy Saver Switch is pushed to the left, electricity flows through the low wattage heaters which warm the outside of the cabinet and, under most conditions, prevent the forming of moisture or water droplets.

No Defrosting

It is not necessary to defrost the freezer or fresh food compartments. Although your refrigerator is designed and equipped to defrost itself automatically, some frost on packages is normal.

Electronic Monitor & Diagnostic System

It keeps an eye on things for you.

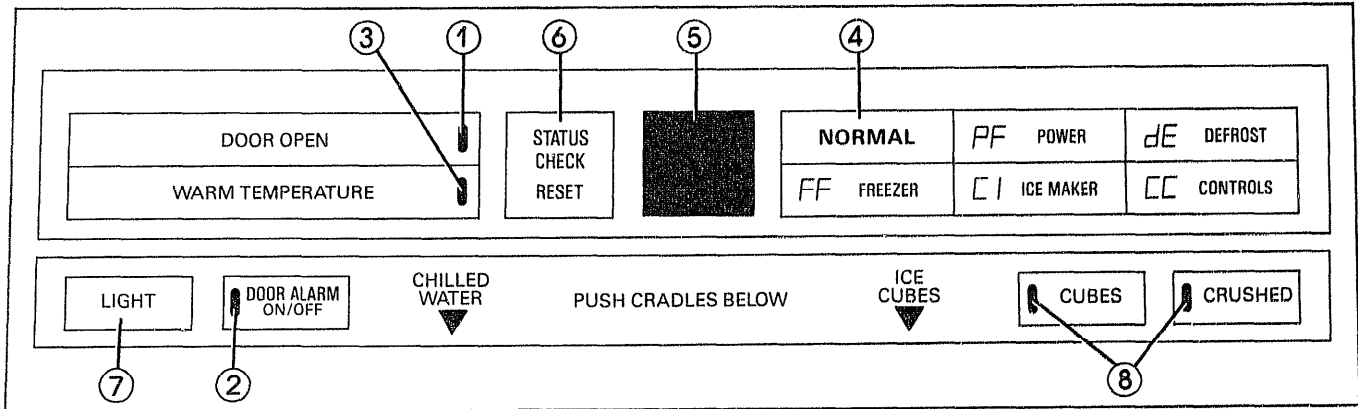

- ① Red signal light flashes to tell you when either door is open.
- ② Green signal light tells you that the Door Alarm beeper has been set to sound after either door has been open 30 seconds.
- ③ Red signal light tells you when freezer foodkeeping temperature is above normal.
- ④ Green lighted word **NORMAL** indicates that no failure has been detected by the diagnostic system.
- ⑤ Flashing green diagnostic codes in the display warn you when:

FF frozen foods should be checked.

PF power has been interrupted.

CI icemaker may not be operating properly.

dE defrost system has failed.

CC freezer control may need to be set for a colder temperature.

What these codes mean—and what to do when they appear—is summarized on the inside of the freezer compartment door and explained more thoroughly on the following pages.

- ⑥ Status Check Reset pad puts a review of the electronic diagnosis of five coded functions at your fingertip and also allows you to erase codes from display.
- ⑦ Electronic control allows you to turn night light in water-and-ice dispenser on and off.
- ⑧ Electronic control allows you to select ice cubes or crushed ice, and green signal light confirms your choice.

When your refrigerator is first plugged in...

All panel lights come on for five seconds, a beep sounds, and lights go off except as follows:

- **PF** flashes in the display. Touch **STATUS CHECK-RESET** pad to erase it.
- Green word **NORMAL** glows.
- Red **WARM TEMPERATURE** light glows if freezer compartment temperature is higher than normal. It goes off when proper foodkeeping temperature is reached.
- Door alarm beeper is activated and green light on **DOOR ALARM** pad glows.
- **CRUSHED** ice selection light glows.
- Red **DOOR OPEN** light flashes if either door is open, goes out when doors are shut.
- Night light in water-and-ice dispenser is off.

(continued next page)

Electronic Monitor & Diagnostic System (continued)

How to Set the Door Alarm

You don't have to set the visual alarm. As long as either door is open, the red DOOR OPEN signal light flashes.

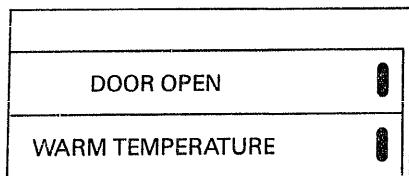

If the green signal light on the DOOR ALARM pad is glowing, the beeper alarm is set. If it's not, touch the pad to turn it on.

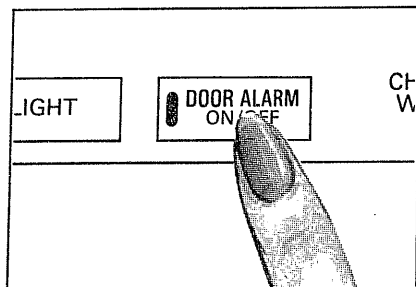

If either door is open for more than 30 seconds, a recurring beep sounds. The light goes out and the beeping stops when you close the door.

There are times when you'll want the Door Alarm beeper turned off. When you're rearranging a lot of food, for example. Just touch the pad. The green light will go out and the beeping will stop.

Deactivating the Door Alarm beeper does not turn the red DOOR OPEN light off—it keeps flashing until the door is closed.

Why the Red Warm Temperature Light Glows.

At first, it's probably because your newly installed refrigerator hasn't completely cooled down yet. Wait a few hours for it to cool, and then the light will go out.

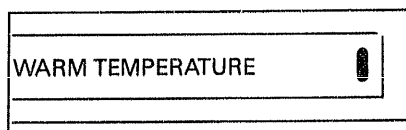

From then on, the red light will glow whenever temperatures inside get too high for proper food storage. If this happens, open the doors only when absolutely necessary, and close them as quickly as possible.

As soon as inside temperatures return to normal, the light goes out.

How the Electronic Monitor and Diagnostic System Works.

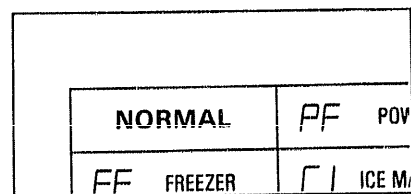

The word NORMAL is lighted in green except when a failure has been detected.

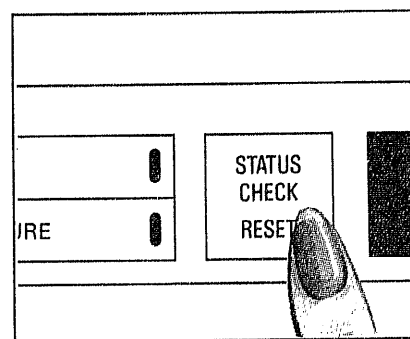

The STATUS CHECK-RESET pad has two functions:

1. You can touch the STATUS CHECK-RESET pad and get a review of the electronic diagnostic codes in order of their priority.
2. You can touch the STATUS CHECK-RESET pad to erase three flashing codes immediately and two codes after the condition that caused them to flash has been corrected (see page 7).

Electronic Monitor & Diagnostic System (continued)

The Electronic Monitor and Diagnostic System alerts you when something starts to go wrong.

If a diagnostic code appears on the display, something needs special attention. To get your attention, the display code flashes until you erase it. The first 6 flashes are accompanied by beeps.

If more than one coded function requires attention at the same time, the one with the highest priority will be displayed first.

Pressing the STATUS CHECK-RESET pad will evaluate all other coded functions. If the NORMAL display is lit during the displaying of a code, that function is operating properly.

Pressing the STATUS CHECK-RESET pad will erase three codes immediately—PF, CI and CC.

The DE and FF codes can only be erased by touching the STATUS CHECK-RESET pad after the condition that caused the code to flash has been corrected.

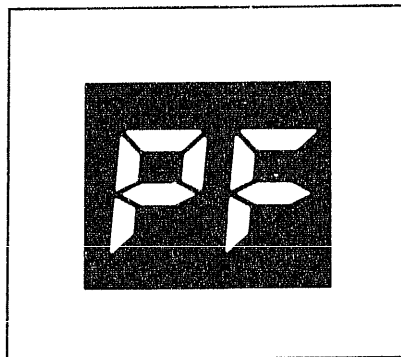

This flashing code tells you the power to the refrigerator has been interrupted for more than 2 seconds. Check the condition of food in both the fresh food and freezer compartments. Touch STATUS CHECK-RESET pad to erase code.

There is no fault with the refrigerator when PF code flashes.

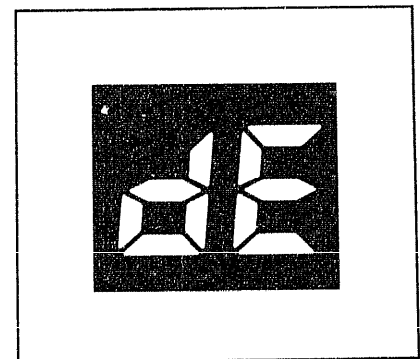

This flashing code tells you something's wrong with the defrost system—keep doors closed to retain cold and call for service. Code flashes until problem is corrected.

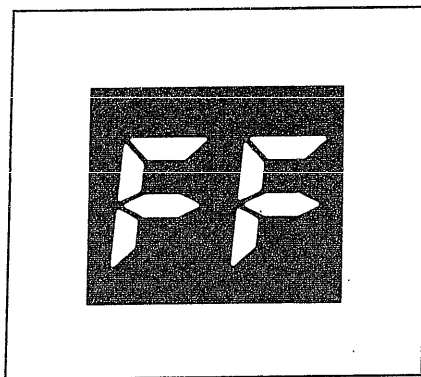

This flashing code tells you to check your frozen food. Has any of it started to thaw? A package may be holding the freezer compartment door open. Don't open the door more often than absolutely necessary while this code is displayed. Touching the STATUS CHECK-RESET pad after the freezer compartment temperature has returned to normal will erase the code.

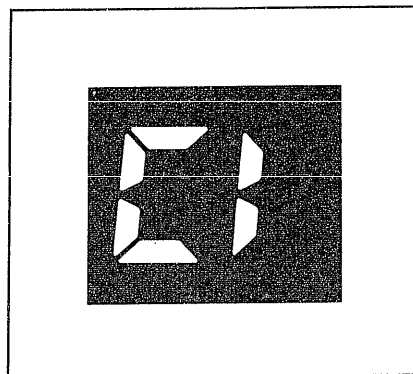

This flashing code tells you to check the automatic icemaker. Ice clumps in the storage bin may have stalled the icemaker. Follow corrective measures described on page 21. If water supply to the icemaker is not connected or not turned on, make sure manual icemaker switch is in the OFF position (see page 10). Code stops flashing when problem is corrected or STATUS CHECK-RESET pad is touched.

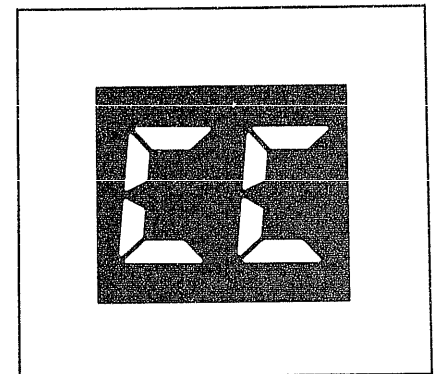



This flashing code tells you to check temperature controls and adjust them if necessary. (See directions on page 4.) Touch STATUS CHECK-RESET pad to erase code. If code reappears after 4 hours, call for service.

Electronic Monitor & Diagnostic System (continued)

Signal Lights and Diagnostic Codes

What they mean, and what to do when they alert you, is summarized on this panel on the inside of the freezer compartment door.

DISPLAY	EXPLANATION / RECOMMENDED ACTION
NORMAL	<p>ALL SYSTEMS OPERATING NORMALLY</p> <p>RESET STATUS CHECK</p> <p>TO CHECK SYSTEM TOUCH STATUS CHECK LOOK FOR "NORMAL" READOUT DURING EACH CODE DISPLAY</p>
DOOR OPEN 	DOORS NOT COMPLETELY CLOSED CHECK FOR OPEN BINS PACKAGES MAY BE BLOCKING DOOR
WARM TEMPERATURE 	THIS MAY OCCUR WHEN REFRIGERATOR IS FIRST TURNED ON OR DOORS LEFT OPEN TOO LONG
FF FREEZER	CHECK FOR THAWING OF FROZEN FOODS LIMIT DOOR OPENINGS TO RETAIN COLD CALL FOR SERVICE IF NECESSARY
PF POWER	POWER HAS BEEN OFF FOR SOME PERIOD OF TIME CHECK CONDITION OF FOOD TOUCH RESET
CI ICE MAKER	CHECK ICE BIN FOR BLOCKAGE TOUCH RESET IF CODE APPEARS AGAIN, CALL FOR SERVICE
dE DEFROST	LIMIT DOOR OPENINGS TO RETAIN COLD CALL FOR SERVICE
CC CONTROLS	CHECK TEMPERATURE CONTROLS ADJUST IF NECESSARY TOUCH RESET IF CODE REAPPEARS WITHIN 4 HRS. CALL FOR SERVICE

SEE YOUR USE AND CARE BOOK FOR COMPLETE INSTRUCTIONS

Panel located on the inside of the freezer compartment door.

Ice & Chilled Water Dispenser

Automatic Icemaker and Ice & Water Dispenser

Your refrigerator has an automatic icemaker and a custom dispenser that dispenses chilled water, ice cubes and crushed ice through the freezer compartment door. Here's how they work.

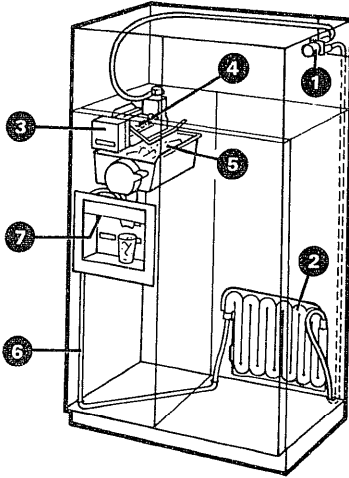

Water flows from the household supply through a

- (1) dual solenoid valve to the
- (2) water reservoir and to the
- (3) automatic icemaker as needed.

Water is frozen in the

- (4) cube mold and ejected into the
- (5) storage bin where a motor-powered auger moves cubes forward into the dispensing unit.

When you touch the **CUBES** pad on front of freezer compartment door, ice cubes will dispense through chute in door when cradle is pressed.

When you touch the **CRUSHED** pad, baffle in housing channels cubes through the crusher and crushed ice falls through chute into glass when cradle is pressed.

Chilled water from reservoir flows through the

- (6) tubing in the door and is dispensed when the cradle is pressed.

- (7) A **light switch** turns the night light in the dispenser on or off when the **LIGHT** pad is touched.

Important Facts about Your Ice & Water Dispenser

- **Your icemaker will produce eight cubes per cycle**—approximately 120 cubes in a 24-hour period—depending on freezer compartment temperature, room temperature, number of door openings and other use conditions.
- **Intermittent dispensing of ice is normal.** If ice flow interruption is more than brief, ice clump(s) may be the cause and should be removed following instructions below and on page 11.
- **Avoid overfilling glasses with ice and using narrow or extra-tall glasses.** This can jam the chute or cause the door in the chute to freeze shut. Periodically open the freezer compartment door and look down into the chute. If ice is blocking the chute, poke it through with a wooden spoon.
- **To help keep bits of ice from being sprayed beyond the glass,** place glass close to ice chute—but not so close that it blocks outgoing ice.
- **Ice should not be dispensed into thin glasses, fine china or delicate crystal**—they can crack or chip from the combined pressure of your hand pressing them against the cradle and ice dropping into the container.
- **Ice should be dispensed before filling glass with soda or other beverage mixes.** This will prevent splashing which is annoying and which, if the splash reaches the ice and water selector switch, could cause it to stick or bind.
- **Beverages and foods should not be quick-chilled in the ice storage bin.** Cans, bottles or food packages in the storage bin may cause the icemaker to malfunction.
- **Ice other than that produced by your icemaker should not be added to the ice storage bin**—it may not crush or dispense well.

Before Using Your Icemaker and Dispenser

If you use your refrigerator before the water connection is made, raise the ice access door and make sure the icemaker feeler arm is in the OFF (up) position as shown below.

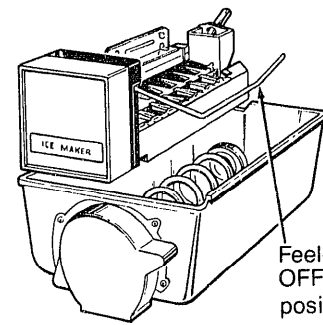
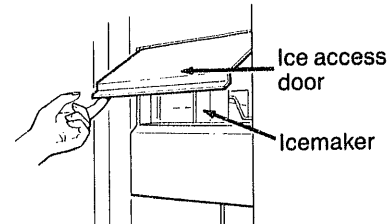

When water supply has been connected to icemaker, move feeler arm to ON (down) position.

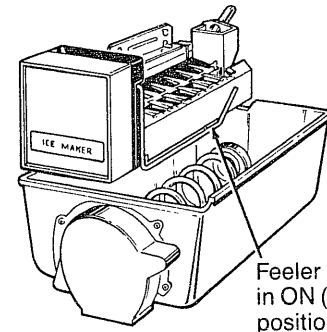

Depress water dispenser cradle for about two minutes to remove trapped air from the water line and to fill water reservoir automatically.

Ice cube mold automatically fills with water after cooling to freezing temperatures. First cubes normally freeze after several hours.

NOTE: With a newly-installed refrigerator, allow about 24 hours for the freezer compartment to cool down to the proper ice-making temperature.

(continued next page)

Storage Drawers

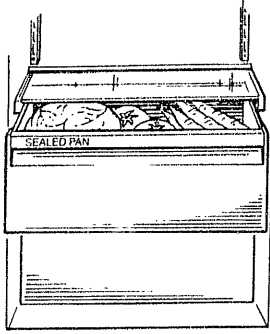

High-Humidity Drawer

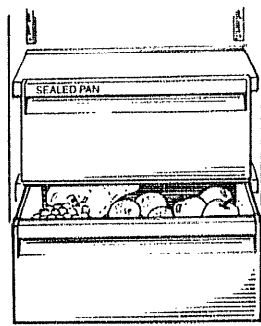

Low-Humidity Drawer

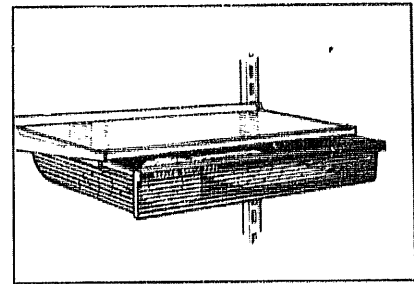

Fruit & Vegetable Drawers

The storage drawers at the bottom of the fresh food compartment are designed to provide high humidity levels required by most vegetables and lower humidity levels required for most fruits.

When replacing the drawers, always push them all the way in.

Storage time will depend upon the type of food and its condition when placed in the drawers.

Excess water which may accumulate in the bottom of the drawers should be emptied and the drawers wiped dry.

High-Humidity Drawer

This refrigerated drawer is designed to keep **unwrapped foods** fresh by retaining the natural moisture content of foods such as:

- Artichokes
- Asparagus
- Beets, topped
- Blueberries
- Carrots
- Celery
- Cherries
- Corn
- Currants
- Greens, leafy
- Lettuce
- Parsley
- Peas, green
- Plums
- Radishes
- Rhubarb
- Spinach
- Tomatoes, ripe

As in any refrigerated storage area, **it is recommended that foods with strong odors be stored wrapped**—foods such as:

- Broccoli
- Brussels Sprouts
- Cabbage
- Cauliflower
- Green Onions
- Parsnips
- Turnips

Low-Humidity Drawer

This refrigerated drawer is designed to provide lower humidity storage for items such as:

- Apples
- Apricots
- Grapes
- Mushrooms
- Nectarines
- Oranges
- Peaches
- Pears
- Raspberries
- Squash, summer
- Strawberries
- Tangerines

Sealed Snack Pan

The Sealed Snack Pan—and the shelf to which it is attached—can be relocated within the fresh food compartment. The sealed drawer retains high humidity for the convenient storage of unwrapped meats and cheese, bacon, hors d'oeuvres, spreads and snacks.

Storage Drawers (continued)

Drawer and Cover Removal

Drawers at the bottom of the fresh food compartment will stop before coming all the way out of the refrigerator, to help prevent contents from spilling onto floor. These drawers can be removed easily by lifting front up slightly and pulling drawer past "stop" location.

To remove drawers and their cover when the fresh food compartment door cannot be opened fully:

1. Empty and remove lower door bins that might interfere.
2. Remove food from the shelf above the upper drawer and take out the shelf. Take food off the glass cover and out of the drawer.

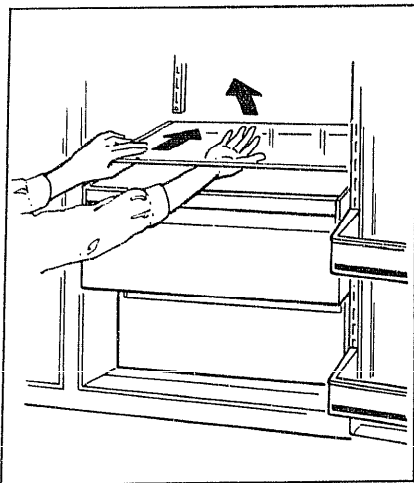

3. Pull the upper drawer partway out. Reach in, push the rear of the glass up; at the same time, push it back until it clears the front-corner retainers.
4. Remove the cover.
5. Pull the upper drawer forward, lift the front to clear stops, and remove the drawer.

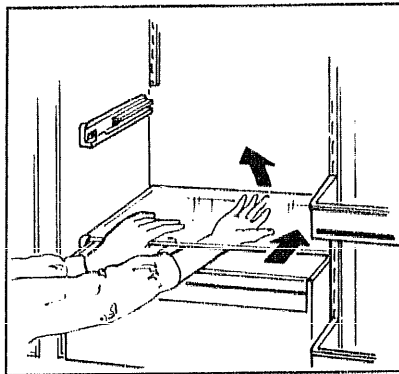

6. Pull the lower drawer partway out. Reach in, push the rear of the glass up and, at the same time, push it back until it clears the front-corner retainers.
 7. Remove the cover.
 8. Remove the drawer.
- After cleaning, replace in reverse order.

Shelf Positions

How to rearrange your shelves

Adjustable Shelves in Both Compartments

Tempered glass shelves in the fresh food compartment and steel wire shelves in the freezer compartment are adjustable, enabling you to make efficient shelf arrangements to fit your family's food storage needs.

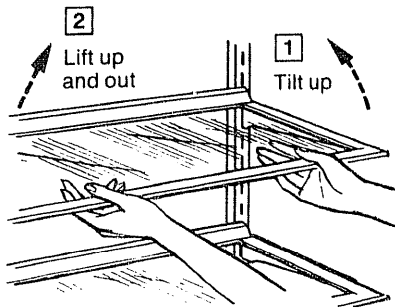

To remove shelves: Tilt shelf up at front, then lift it up and out of tracks on rear wall of refrigerator.

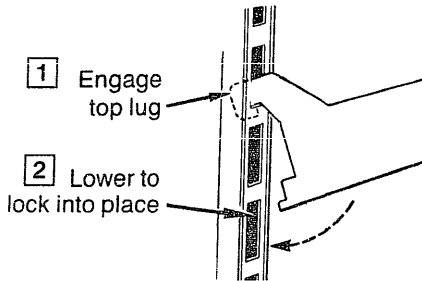

To replace shelves: Select desired shelf height. With shelf front raised slightly, engage top lugs in tracks at rear of cabinet. Then lower front of shelf until it locks into position.

Quick Serve™ System

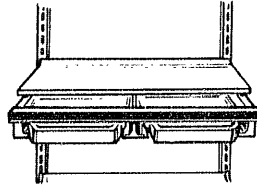

Cooking-serving-storage dishes with Lexan® polycarbonate resin see-through lids fit into a slide-out rack that, together with the shelf to which it attaches, can be relocated in the fresh food compartment.

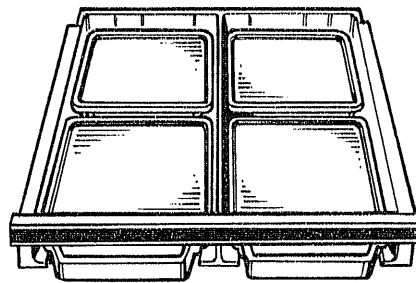

Dishes and lids are:

- safe for use in microwave ovens
- safe for use in refrigerators and freezers
- dishwasher safe

Only the dishes are safe for use in conventional ovens at temperatures up to 400°F.

CAUTION:

• Dishes and lids are not designed for range top cooking or broiler use. Such use can be hazardous.

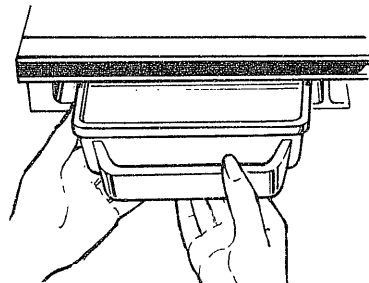

- Use both hands when removing a dish, especially when it is full. Otherwise, it may slip out of your grasp, fall and spill.
- Lids cannot withstand the heat generated in conventional ovens.

Removable Wine Rack

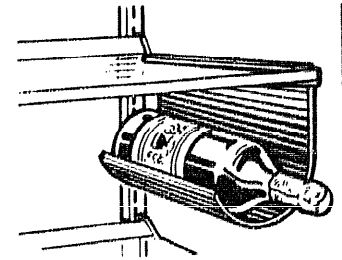

The wine rack is designed to hold a bottle on its side and will fit on any shelf.

To relocate the wine rack:

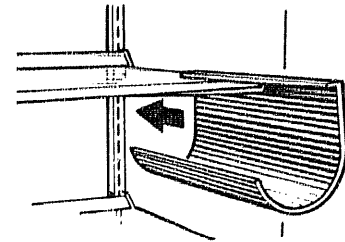

Pull the wine rack straight out, position its lip over either edge of the shelf you want to suspend it from and push it all the way in.

Adjustable Bins on Both Doors

Door bins can be moved up and down to meet your varying on-the-door storage requirements.

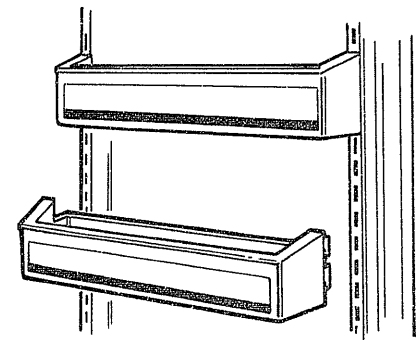

To remove: Lift the bin straight up until mounting hooks disengage.

To relocate: Select desired bin height, engage the bin's hooks in slots on the tracks of the door and push in and down. The bin will hook in place.

Care and Cleaning

Cleaning—Outside

Electronic monitor and diagnostic system panels. Clean the panels on the outside and inside of the freezer compartment door with a soft, clean cloth lightly dampened with water. Do not use cleaning sprays or large amounts of water—the liquid can run down and damage the control mechanisms.

The water and ice dispenser spill shelf should be wiped dry immediately to prevent spotting. Water left on the shelf may leave deposits that you can remove by soaking in undiluted vinegar. You can also use a paste of non-precipitating water softener (such as Calgon brand) and water, or one teaspoon of citric acid powder per pint of hot tap water. Soak until the deposit disappears or becomes loose enough to rinse away. Usually 30 minutes soaking time is adequate. Avoid using wax on the spill shelf and trim.

The door handles and trim can be cleaned with a cloth dampened with a solution of mild liquid dishwashing detergent and water. Dry with a soft cloth. Don't use wax on the door handles and trim.

Keep the finish clean. Wipe with a clean cloth lightly dampened with kitchen appliance wax or mild liquid dishwashing detergent. Dry and polish with a clean, soft cloth. Do not wipe the refrigerator with a soiled dishwashing cloth or wet towel. These may leave a residue that can erode the paint. Do not use scouring pads, powdered cleaners, bleach or cleaners containing bleach because these products can scratch and weaken the paint finish.

Protect the paint finish. The finish on the outside of the refrigerator is a high quality, baked-on paint finish. With proper care, it will stay new-looking and rust-free for years. Apply a coat of kitchen/appliance wax when the refrigerator is new and then at least twice a year.

Appliance Polish Wax & Cleaner (Cat. No. WR92X216) is available from GE Appliance Parts Marts.

Cleaning—Inside

Inside the fresh food and freezer compartments should be cleaned at least once a year. Unplug the refrigerator before cleaning. If this is not practical, wring excess moisture out of sponge or cloth when cleaning around switches, lights or controls.

Use warm water and baking soda solution—about a tablespoon of baking soda to a quart of water. This both cleans and neutralizes odors. Rinse thoroughly with water and wipe dry.

Other parts of the refrigerator—including door gaskets, meat and vegetable drawers, ice storage bin and all plastic parts—can be cleaned the same way. Do not use cleansing powders or other abrasive cleaners.

To help prevent odors, leave an open box of baking soda in the rear of the refrigerator, on the top shelf. Change the box every three months. An open box of baking soda in the freezer will absorb stale freezer odors.

Do not wash any plastic parts from your refrigerator in your automatic dishwasher.

Quick Serve dishes and lids can be cleaned in an automatic dishwasher or by hand with liquid dishwashing detergent and water. You can remove stains by soaking them in a bleach-and-water solution—one part chlorine bleach to three parts water. (Stubborn stains may require two or more hours of soaking.) Use a plastic scouring pad to remove burned-on soil. Do not use cleansing powders or other abrasive cleaners.

Condenser

The condenser is located behind the grille in the cooling compartment above the refrigerator. For most efficient operation, you need to keep the condenser clean.

To clean the condenser: Turn the freezer compartment temperature control to OFF.

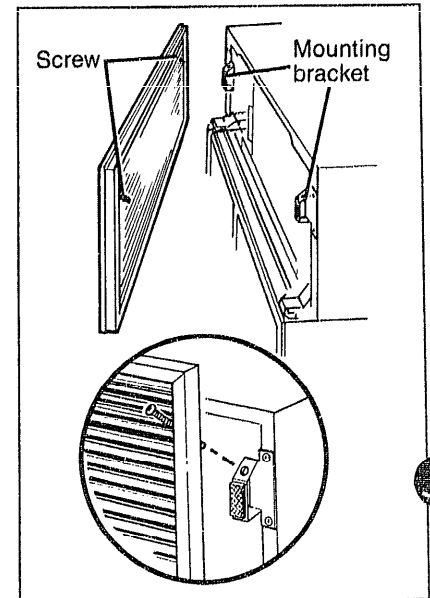

Remove the grille. With a #1 Phillips screwdriver, back the screw at each end of the grille out of the hole in each mounting bracket, but not out of the hole in the grille. Then grasp the grille at both sides and pull it forward and down.

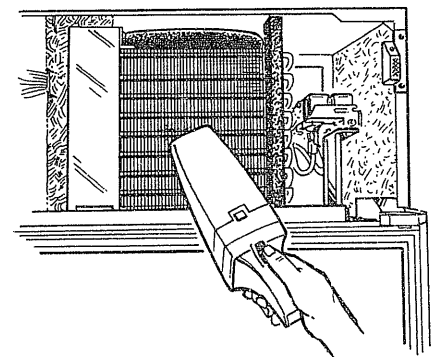

With grille removed, use a "soft" bristle brush to loosen and a cordless vac or vacuum hose to remove dust and lint particles that have accumulated on the condenser.

Replace the grille, position it so the catch on the grille hooks the flange on the cooling unit. Then move the bottom of the grille into the track in the cabinet top trim, line up the sides of the grille with the cabinet side trim, and drive the screws back into the holes in the mounting brackets.

When the grille is back in place, turn the temperature control back on.

CAUTION: Grille is louvered for proper air circulation. Do not cover or alter the grille, or damage to cooling unit may occur.

The condenser should be cleaned at least once a year.

Light bulb replacement

In Fresh Food Compartment

Light bulbs and sockets are located at the top rear above a flexible light shield.

1. Unplug refrigerator or turn off power at the circuit breaker or fuse box.

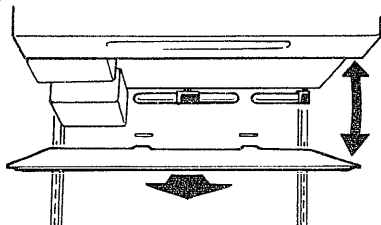

2. Remove light shield by reaching in and back and pulling the light shield toward you. (It will bend to free tabs from grooves in rear wall.)

3. After replacing with same size bulb, reinstall shield and plug refrigerator back in.

In Freezer Compartment

1. Unplug refrigerator.

2. Remove shelf just below light shield. (Shelf will be easier to remove if it is emptied first.)

3. Pull light shield toward you. (It will bend to free tabs from grooves in rear wall.)

4. After replacing with same size bulb, reinstall shield and shelf and plug refrigerator back in.

Door panel inserts

Your refrigerator is designed to accept decorative fresh food and freezer compartment door insert panels to match your kitchen cabinets or blend with your kitchen decor.

The panels are held in place by the trim on the door.

See your Installation Instructions (Pub. No. 49-6423) for door insert panel dimensions.

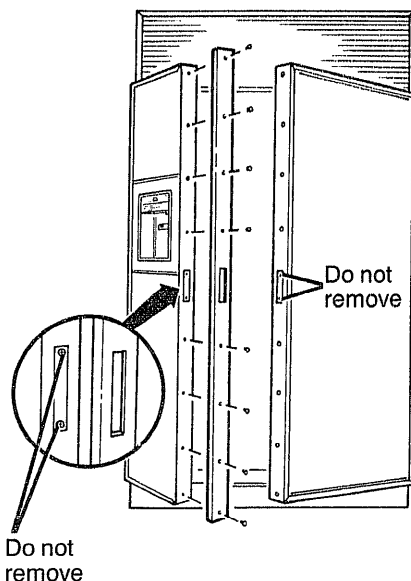

To install door panel inserts:

1. Remove the door handles by backing out 9 screws that hold each handle to its door. Do not remove the two screws (A) that hold the metal plate to each door. Save the screws. To prevent tearing of screw holes, one person should hold the handle in place while the other removes the screws.

2. Insert the panels into the door frame channels and push firmly to make sure the panels slide all the way in.

3. Reinstall the door handles and secure them with their screws.

• If panels are less than 1/4" thick, add filler behind them to assure proper fit.

• If panels are more than 1/4" thick, they must be routed to a 1/4" thickness (1/4" wide at the top, bottom and hinge sides, 1/2" wide at the handle side) in order to fit into the channels.

Additional routing may be required when decorative raised door panel inserts more than 1/4"-thick are used—on the hinge side to clear cabinet side trim and/or an adjacent cabinet and countertop, and on the handle side to provide room for a comfortable handle grip. See your Installation Instructions for detailed instructions.

When you go on vacation

For extended vacations or absences, remove food and shut off power to the refrigerator at fuse box or circuit breaker. Clean the interior with baking soda solution of one tablespoon of soda to one quart of water. Wipe dry. To prevent odors, leave open box of soda in refrigerator. Leave doors open.

For shorter vacations, remove perishable foods and leave controls at regular settings. However, if room temperature is expected to drop below 60°F., follow same instructions as for extended vacations.

Move the icemaker feeler arm to the OFF (up) position and be sure to shut off the water supply to the refrigerator.

Installation Requirements—IMPORTANT... Please Read Carefully.

See the Installation Instructions for complete details.

How to connect electricity

For personal safety, this appliance must be properly grounded.

The power cord of this appliance is equipped with a three-prong (grounding) plug which mates with a standard three-prong (grounding) wall outlet (Fig. 1) to minimize the possibility of electric shock hazard from this appliance.

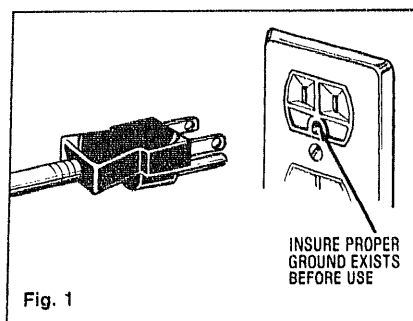

Have wall outlet and circuit checked by a qualified electrician to make sure outlet is properly grounded.

Where a standard two-prong wall outlet is encountered, it is your personal responsibility and obligation to have it replaced with a properly grounded three-prong wall outlet.

DO NOT, UNDER ANY CIRCUMSTANCES, CUT OR REMOVE THE THIRD (GROUND) PRONG FROM THE POWER CORD.

DO NOT USE AN ADAPTER PLUG TO CONNECT THE REFRIGERATOR TO A TWO-PRONG OUTLET.

DO NOT USE AN EXTENSION CORD WITH THIS APPLIANCE.

The refrigerator should always be plugged into its own individual electrical outlet—(115 volt, 60 Hertz, single phase AC—protected by a 20-amp. time delay fuse or circuit breaker). This is recommended for best performance and to prevent overloading house wiring circuits, which could cause a fire hazard from overheating wires.

Refrigerator Location

Install the refrigerator on a floor strong enough to support it when it is fully loaded.

Do not install refrigerator where temperature will go below 60°F. because it will not run often enough to maintain proper temperatures.

Also see Energy-Saving Tips regarding location.

Clearances

If the refrigerator is to be installed in a corner, allow 2" between the hinges of the refrigerator and the wall to assure a 90° door opening capability.

No other clearances at top, sides or back are required.

Water Supply to Icemaker

You will need to connect your icemaker to a cold water line. A water supply kit containing copper tubing, shut-off valve, fittings and instructions is available at extra cost from your dealer.

Levelers

Rollers near each front corner of the refrigerator are adjustable.

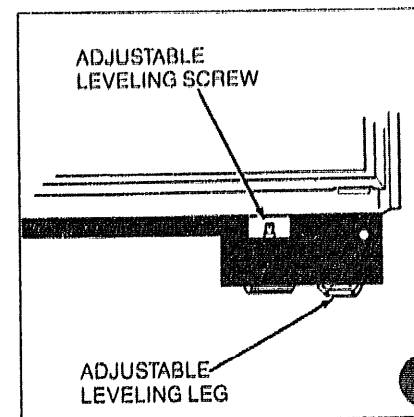

Turn the roller adjusting screws clockwise to raise the refrigerator, counterclockwise to lower it. Use an adjustable wrench, 3/8" ratchet and socket, or pliers.

Lower the leveling legs at each front corner of the cabinet until the legs just start to support the cabinet. Use a crescent wrench or 1 1/4" open end wrench.

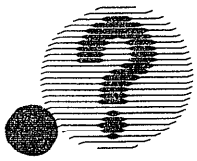

Questions? Use This Problem Solver

PROBLEM	POSSIBLE CAUSE AND REMEDY
NO PANEL TOUCH PAD RESPONSE	<ul style="list-style-type: none">• If interior light is not on, refrigerator may not be plugged in at wall outlet.• If plug is secure and the refrigerator still fails to operate, plug a lamp or a small appliance into the same outlet to determine if there is a tripped circuit breaker or burned out fuse.
REFRIGERATOR DOES NOT OPERATE	<ul style="list-style-type: none">• May be in defrost cycle when motor does not operate for about 30 minutes.• Temperature control in OFF position.• If the interior light is not on, the refrigerator may not be plugged in at the wall outlet or the electrical connection between the cooling unit and the cabinet may be loose.• If the plugs are secure and the refrigerator fails to operate, plug a lamp into the same outlet to determine if there is tripped circuit breaker or burned out fuse.
MOTOR OPERATES FOR LONG PERIODS	<ul style="list-style-type: none">• Modern refrigerators with more storage space and a larger freezer compartment require more operating time.• Normal when refrigerator is first delivered to your home—usually requires 24 hours to completely cool down.• Large amounts of food placed in refrigerator to be cooled or frozen.• Hot weather—frequent door openings.• Door left open.• Temperature controls are set too cold. Refer to page 4.• Condenser needs cleaning. Refer to page 16.• Check ENERGY-SAVING TIPS on page 2.
MOTOR STARTS & STOPS FREQUENTLY	<ul style="list-style-type: none">• Temperature control starts and stops motor to maintain even temperatures.
VIBRATION OR RATTLING	<ul style="list-style-type: none">• If refrigerator vibrates, more than likely it is not resting solidly on the floor. The front roller screws need adjusting, or floor is weak or uneven. Refer to LEVELERS on page 18.• If dishes vibrate on shelves, try moving them. Slight vibration is normal.
FOODS DRY OUT	<ul style="list-style-type: none">• Foods not covered, wrapped or sealed properly.
FRESH FOOD OR FREEZER COMPARTMENT TEMPERATURE TOO WARM	<ul style="list-style-type: none">• Temperature control not set cold enough. Refer to page 4.• Warm weather—frequent door openings.• Door left open for long time.• Package may be holding door open.
DOORS NOT CLOSING PROPERLY	<ul style="list-style-type: none">• Refrigerator not level. Adjust levelers, see page 18. When cabinet is level, doors will close gently and securely.

(continued next page)

The Problem Solver (continued)

PROBLEM	POSSIBLE CAUSE AND REMEDY
OPERATING SOUNDS	<ul style="list-style-type: none"> • The high speed compressor motor required to maintain near zero temperatures in the large freezer compartment may produce higher sound levels than your old refrigerator. • Normal fan air flow—one fan blows cold air through the refrigerator and freezer compartments—another fan cools the compressor motor. • These NORMAL sounds will also be heard from time to time: <ul style="list-style-type: none"> • Defrost timer switch clicks at defrost. • Defrost water dripping. • Temperature control clicks ON or OFF. • Refrigerant boiling or gurgling. • Cracking or popping of cooling coils caused by expansion and contraction during defrost and refrigeration following defrost. • Ice cubes dropping into the bin and water running in pipes as icemaker refills.
FROST OR ICE CRYSTALS ON FROZEN FOOD	<ul style="list-style-type: none"> • Door may have been left ajar or package holding door open. • Too frequent or too long door openings. • Frost within package is normal.
SLOW ICE CUBE FREEZING	<ul style="list-style-type: none"> • Door may have been left ajar. • Turn temperature of freezer compartment colder.
ICE CUBES HAVE ODOR/TASTE	<ul style="list-style-type: none"> • Old cubes need to be discarded. • Ice storage bin needs to be emptied or washed. • Unsealed packages in refrigerator and/or freezer compartments may be transmitting odor/taste to ice cubes. • Interior of refrigerator needs cleaning. Refer to page 16. • Poor-tasting incoming water. Install water filter—see page 11.
WATER HAS POOR TASTE/ODOR	<ul style="list-style-type: none"> • If water dispenser has not been used for an extended period, dispense water in regular manner until all water in reservoir is replenished with fresh water. • Poor-tasting incoming water. Install water filter—see page 11.
WATER IN FIRST GLASS IS WARM	<ul style="list-style-type: none"> • Allow about 24 hours for water to cool to proper temperature after refrigerator is first installed. • If water dispenser has not been used for extended period, water in first glass will not be as cool as in succeeding glasses. • If water reservoir has been drained, allow several hours for replenished supply to chill.
WATER DISPENSER DOES NOT WORK	<ul style="list-style-type: none"> • Water supply line turned off or not connected. • Supply line may be clogged with sediment.

PROBLEM	POSSIBLE CAUSE AND REMEDY
AUTOMATIC ICEMAKER DOES NOT WORK	<ul style="list-style-type: none"> • Icemaker feeler arm in OFF (up) position. • Water supply turned off or not connected. • Freezer compartment too warm. • Cubes too small—water shut-off valve connecting refrigerator to home water line may be clogged. • Sometimes cubes fuse to the side of the ice mold and hold the feeler arm in the OFF (up) position. Remove this ice to restart the icemaker. • When reaching for cubes by hand, you may have pushed the feeler arm into the OFF (up) position by mistake. • Piled up cubes in storage bin may cause icemaker to shut off prematurely. With icemaker feeler arm in OFF (up) position, level cubes in bin by hand.
MOISTURE FORMS ON OUTSIDE OF REFRIGERATOR OR ON DIVIDER BETWEEN FRESH FOOD AND FREEZER	<ul style="list-style-type: none"> • Not unusual during periods of high humidity. • Make sure the energy saver switch is in the ON (left) position. <div style="border: 1px solid black; padding: 5px; width: fit-content; margin: 10px auto;"> SET HERE IF MOISTURE APPEARS ON EXTERIOR  OFF </div>
MOISTURE COLLECTS INSIDE	<ul style="list-style-type: none"> • Too frequent or too long door openings. • In humid weather, air carries moisture into refrigerator when doors are opened.
REFRIGERATOR HAS ODOR	<ul style="list-style-type: none"> • Foods with strong odors should be tightly covered. • Check for spoiled food. • Interior needs cleaning. Refer to page 16. • Keep open box of baking soda in refrigerator; replace every three months.
INTERIOR LIGHT DOES NOT WORK	<ul style="list-style-type: none"> • Thermostat may have tripped the lights off. Wait 30 minutes with door shut and try again. • No power at outlet. • Light bulb needs replacing. See page 17.

If you need more help...call, toll free:
The GE Answer Center®
800.626.2000
 consumer information service

If You Need Service

To obtain service, see your warranty on the back page of this book.

We're proud of our service and want you to be pleased. If for some reason you are not happy with the service you receive, here are three steps to follow for further help.

FIRST, contact the people who serviced your appliance. Explain why you are not pleased. In most cases, this will solve the problem.

NEXT, if you are still not pleased, write all the details—including your phone number—to:

Manager, Consumer Relations
GE Appliances
Appliance Park
Louisville, Kentucky 40225

FINALLY, if your problem is still not resolved, write:

Major Appliance
Consumer Action Panel
20 North Wacker Drive
Chicago, Illinois 60606

YOUR GENERAL ELECTRIC REFRIGERATOR WARRANTY

Save proof of original purchase date such as your sales slip or cancelled check to establish warranty period.

WHAT IS COVERED

FULL ONE-YEAR WARRANTY

For one year from date of original purchase, we will provide, free of charge, parts and service labor in your home to repair or replace **any part of the refrigerator** that fails because of a manufacturing defect.

FULL FIVE-YEAR WARRANTY

For five years from date of original purchase, we will provide, free of charge, parts and service labor in your home to repair or replace **any part of the sealed refrigerating system** (the compressor, condenser, evaporator and all connecting tubing) that fails because of a manufacturing defect.

This warranty is extended to the original purchaser and any succeeding owner for products purchased for ordinary home use in the 48 mainland states, Hawaii and Washington, D.C. In Alaska the warranty is the same except that it is LIMITED because you must pay to ship the product to the service shop or for the service technician's travel costs to your home.

All warranty service will be provided by our Factory Service Centers or by our authorized Customer Care® servicers during normal working hours.

Look in the White or Yellow Pages of your telephone directory for GENERAL ELECTRIC COMPANY, GENERAL ELECTRIC FACTORY SERVICE, GENERAL ELECTRIC-HOTPOINT FACTORY SERVICE or GENERAL ELECTRIC CUSTOMER CARE® SERVICE.

WHAT IS NOT COVERED

- Service trips to your home to teach you how to use the product.

Read your Use and Care material.

If you then have any questions about operating the product, please contact your dealer or our Consumer Affairs office at the address below, or call, toll free:

The GE Answer Center®
800.626.2000
consumer information service

- Improper installation.

If you have an installation problem, contact your dealer or installer. You are responsible for providing adequate electrical, plumbing and other connecting facilities.

- Replacement of house fuses or resetting of circuit breakers.

- Failure of the product if it is used for other than its intended purpose or used commercially.

- Damage to product caused by accident, fire, floods or acts of God.

WARRANTOR IS NOT RESPONSIBLE FOR CONSEQUENTIAL DAMAGES.

Some states do not allow the exclusion or limitation of incidental or consequential damages, so the above limitation or exclusion may not apply to you. This warranty gives you specific legal rights, and you may also have other rights which vary from state to state. To know what your legal rights are in your state, consult your local or state consumer affairs office or your state's Attorney General.

Warrantor: General Electric Company

If further help is needed concerning this warranty, write:

Manager—Consumer Affairs, General Electric Company, Appliance Park, Louisville, KY 40225

Part No. 162D1936P001
Pub. No. 49-6551



BISW42E
BISB42E