

WARNING:
TO AVOID RISK OF ELECTRICAL SHOCK
TURN OFF OR DISCONNECT FROM POWER
WHILE INSTALLING OR SERVICING UNIT

Installation Instructions: 348-8320 (M-FP-22BLPBLKC) | 2ft x 2ft 4000 Lumen LED Flat Panel Light

WARNING



- When using product, basic precautions should always be followed.
- Read and follow these instructions and heed all warnings.
- Carefully read and understand the information given in this manual before beginning installation. Failure to do so could lead to electric shock, fire, or other injuries which could be hazardous or even fatal.
- Save these instructions and warnings.

CAUTION



- Compatible with 0-10V dimmer switches

- Do not install on radiant heated ceiling.
- This item is designed for dry use and is not waterproof.
- Do not place this item in a humid or dusty environment.
- Do not use in areas with temperature higher than 104° Fahrenheit.
- This is not a vapor proof light.

PRE-INSTALL

1. Before assembly compare package contents with list to make sure all parts are present.
2. Shut off power at circuit breaker before removing existing fixture. If you are unfamiliar with electrical installations, it is recommended to have a qualified electrician complete your installation.
3. Select suitable location that can support the weight of the fixture. Determine mounting method (Page 2.).
4. Use the Correlated Color Temperature (CCT) Selection Switch to select the color temperature that best fits your environment.

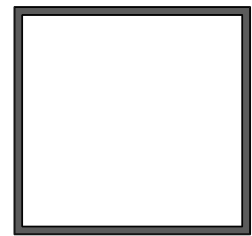

Tools Required

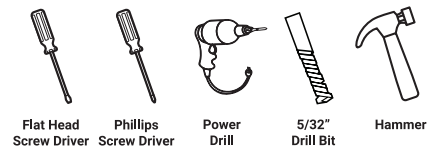

HARDWARE

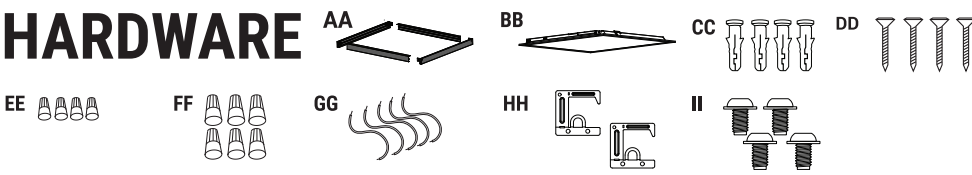

Part	Description	Qty	Part	Description	Qty
AA	Light Frame	1	EE	Wire Nuts (small)	4
BB	LED Light	1	FF	Wire Nuts (large)	6
CC	Drywall Anchors	4	GG	Wire Extension	5
DD	Mounting Screws	4	HH	Ceiling Clips	2
			II	Small Screws	4

Question or Comments?

Customer Service 1-800-205-6201

Installation Instructions: 348-8320 (M-FP-22BLPBLKC) | 2ft x 2ft 4000 Lumen LED Flat Panel Light

INSTALLATION INSTRUCTIONS

Flush Mount Installation

1. Connect the four sides of the Light Frame (AA) refer to Figure 1.
2. Place the Light Frame (AA) on the ceiling where you want to install the LED Light (BB) and mark the position of the holes onto the ceiling. Then take your power drill with a 5/32 diameter drill bit inserted and drill a 1" deep hole into the mounting surface. Refer to Figure 2.
3. Insert the Drywall Anchors (CC) into the drilled holes. Refer to Figure 3.
4. Raise the Light Frame (AA) back into position and insert the Mounting Screws (DD) into the Drywall Anchors (CC). Secure the light frame (AA) by tightening the mounting screws (DD). Refer to Figure 4.
5. Depress the clips on the edge of the Light Frame (AA) to remove the side of the frame. Refer to Figure 5.
6. Detach the cover that rests over the electrical cables on the LED light (BB) with a Phillips head screwdriver. Refer to Figure 6.
7. Connect the corresponding wires from the junction box to the flat panel light through the knockout in the cover plate using the provided wire nuts; refer to Figure 7. Black supply wire to the fixture's black wire, white neutral wire to the fixture's white wire, and grounding wire to the fixture's yellow-green grounding wire. It is recommended to insulate with electrical tape for added security by wrapping the electrical tape around and below the wire nut connection. If you are attaching this light to a dimmer switch, connect the purple wire from the dimmer to the purple wire attached to the light, and connect the pink wire from the dimmer to the pink wire attached to the light.
8. Choose your desired color temperature on the back of the light.
9. Reattach the cover to the LED Light to protect the wire connections. Lift the LED Light (BB) into place and slide it into the mounting frame (AA). Refer to Figure 8.
10. Snap the edge of the Light frame (AA) back into position. Refer to Figure 9.
11. Return power to the fixture.

Figure 5.

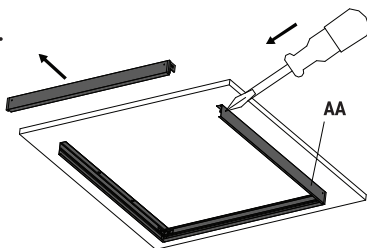

Figure 1.

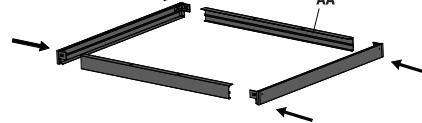

Figure 2.

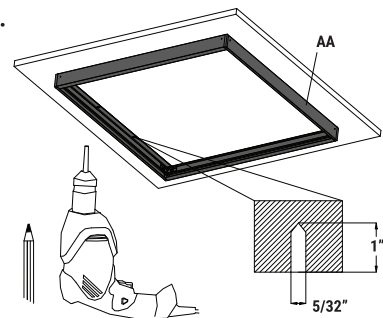

Figure 3.

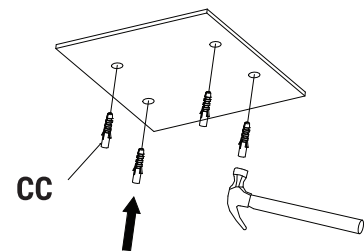

Figure 4.

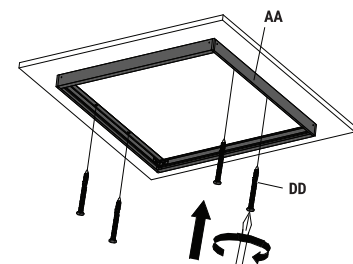
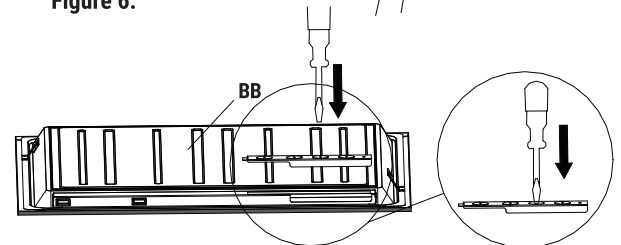

Figure 6.



Installation Instructions: 348-8320 (M-FP-22BLPBLKC) | 2ft x 2ft 4000 Lumen LED Flat Panel Light

Figure 7.

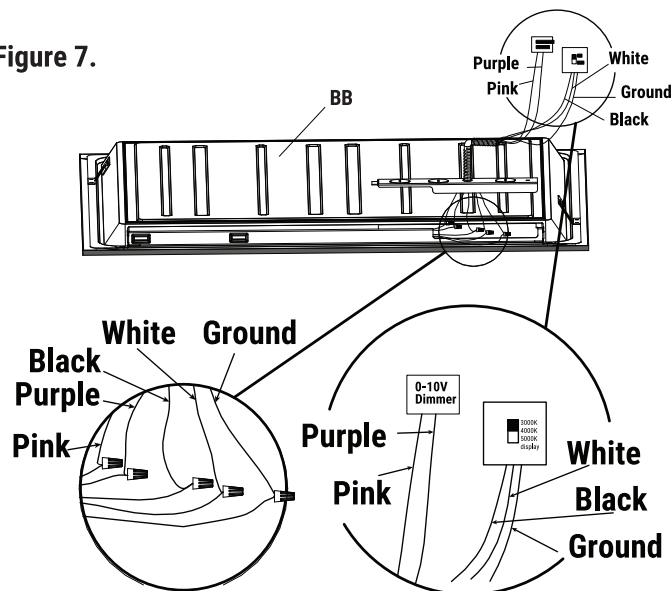

Figure 8.

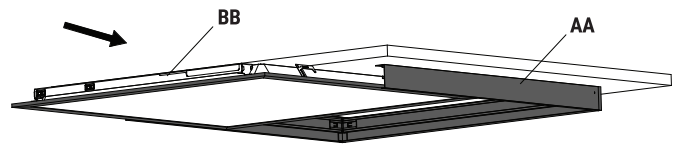
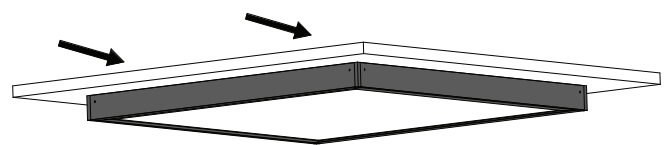

Figure 9.



INSTALLATION INSTRUCTIONS

Drop Ceiling Installation

1. Safety concern! Always turn off the power at the breaker when installing light fixtures.
2. Place the LED, into the open ceiling space of your choosing, refer to Figure 10.
3. Remove the small screws from the two corners of the light. Then attach the ceiling clips (HH) by placing them in the corners and insert the provided small screws (II) and tighten them into place.
4. Fold the two clips, so the clip is perpendicular to the flat panel light. Refer to Figure 11.
5. Set the Light into place connecting each clip to the frame of the drop ceiling.
6. With the light safely placed on the ceiling, removed the metal plate from the LED flat panel light's junction box and remove the metal knockouts.
7. Connect the corresponding wires from the junction box to the flat panel light through the knockout in the cover plate using the provided wire nuts. Refer to Figure 12. Black supply wire to the fixture's black wire, white neutral wire to the fixture's white wire, and grounding wire to the fixture's yellow green grounding wire. It is recommended to insulate with electrical tape for added security by wrapping the electrical tape around and below the wire nut connection. If you are attaching this light to a dimmer switch, connect the purple wire from the dimmer to the purple wire attached to the light, and connect the pink wire from the dimmer to the pink wire attached to the light.
8. Choose your desired color temperature on the back of the light.
9. Once power is connected, reattach the metal plate to the junction box. Refer to Figure 13.
10. Return power to the fixture to ensure it operates properly.

WARNING:
TO AVOID RISK OF ELECTRICAL SHOCK
TURN OFF OR DISCONNECT FROM POWER
WHILE INSTALLING OR SERVICING UNIT

Installation Instructions: 348-8320 (M-FP-22BLPBLKC) | 2ft x 2ft 4000 Lumen LED Flat Panel Light

Figure 10.

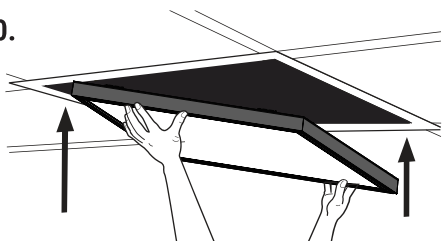

Figure 12.

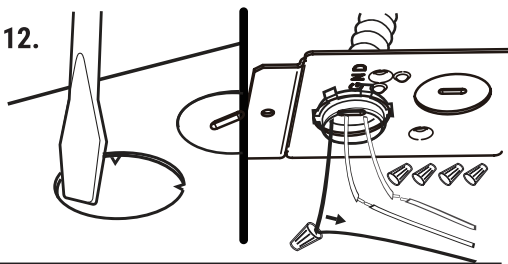

Figure 11.

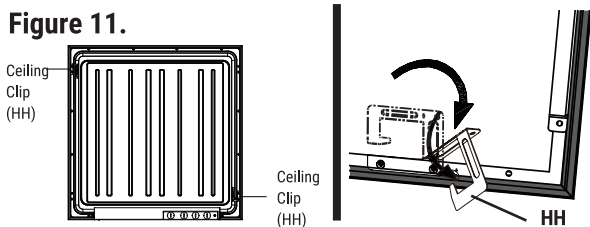
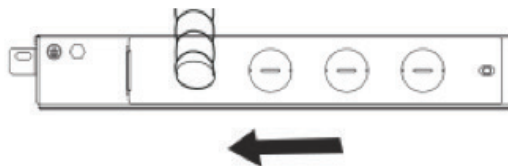

Figure 13.



Selectable Color Temperature

3000K (SOFT WHITE)	4000 Lumens
4000K (BRIGHT WHITE)	4000 Lumens
5000K (DAYLIGHT)	4000 Lumens

This LED flat panel light, comes with a display function. The display function cycles through the three selectable color temperatures. This is recommend for models on display in a store, and not for use when a light is installed and being used by a final user.

TROUBLESHOOTING

Problem	Possible Cause	Solution
The fixture does not light.	The power is off.	Check that the power supply is ON.
	There is a bad wire connection.	Check the wiring.
	The switch is defective.	Test or replace the switch.
Circuit breaker trips when power is sent to the light.	Incorrect wire connections, or hot wires are grounding out.	Ensure wires are connected correctly.
Dimmer switch does not work.	Incompatible dimmer switch	Check compatibility chart on the next page.



Installation Instructions: 348-8320 (M-FP-22BLPBLKC) | 2ft x 2ft 4000 Lumen LED Flat Panel Light

CARE AND CLEANING

Your fixture is made from quality materials that will last an extended period of time with proper care, including periodically cleaning the surface of the fixture.

1. Use a mild, non-abrasive cleaner. Do not use any solvents or harsh cleaning agents.
2. Use a soft, non-abrasive cloth.
3. Lightly spray cleaner onto the cloth. Do not spray liquid cleaners directly onto LEDs, wires, or any part of this product.
4. Lightly wipe down fixture with damp cloth. Allow product to dry completely before restoring power and using LED lights.

DIMMING FEATURE

This fixture is compatible with most 0-10V dimmers, though dimming performance is impacted differently by each dimmer model. A dimmer's settings for brightness range, as well as the number of other LED lights wired on the same circuit can change this fixture's dimming ability.

Preferred dimmers for this model include; Lutron DTVV-IV/WH, DVSTV-WH, NFTV-WH, NTSTV-DV-WH; Leviton IP710-DLZ, DD710-BDZ; Cooper SF10P-W.

EYES



- Do not look directly at the LED lights for any length of time.
- Do not remove protective lens covering LED lights.



This product is guaranteed against failure due to factory defects in materials or workmanship for five (5) years from the date of purchase. This warranty is non-transferable and applies only to the original owner. Proof of purchase required for repair or replacement. This warranty does not cover normal wear of parts or damage resulting from any misuse of the product. Misuse of the product includes but is not limited to: using in extreme weather conditions, opening the housing of the product, or attempted remodel/alterations made to product.

Question or Comments?

Customer Service 1-800-205-6201

**Patriot
LIGHTING®**