

# electric

## USER MANUAL

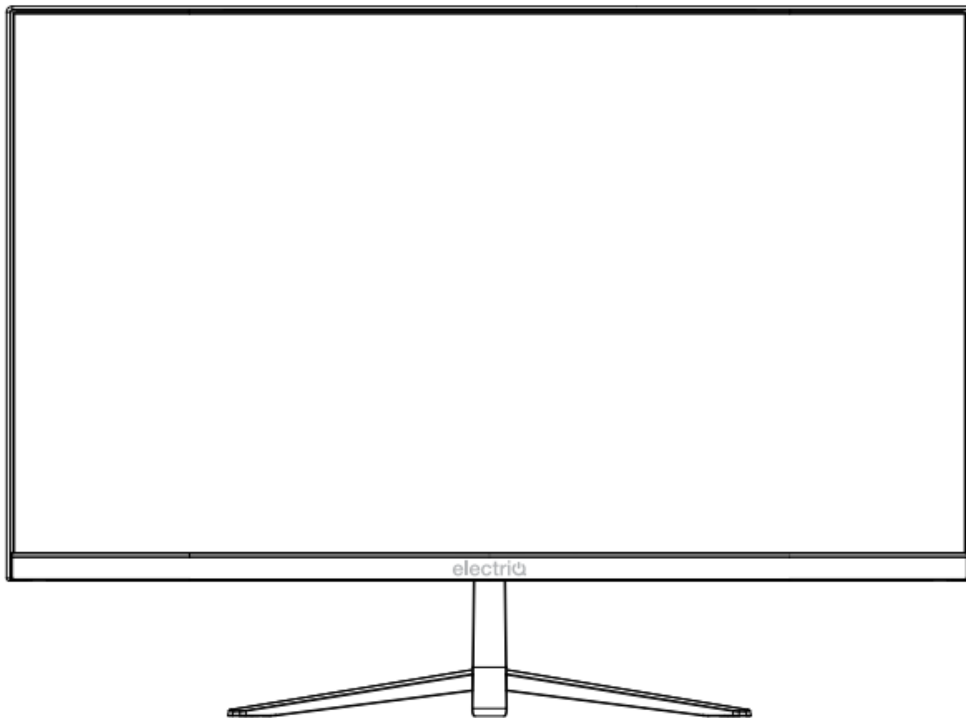

### **23.8 INCH SLIM LED MONITOR** **eiQ-24FHD75IS-V2**

Thank you for choosing electric  
Please read the user manual before using this monitor and keep it safe for future reference

Visit [www.electric.co.uk](http://www.electric.co.uk) to view our entire range of Intelligent Electricals.

# SETTLING IN OK?

---

We hope this has been helpful to you.

We would love to see how you're getting on with your new purchase, so please share any snaps you have on the platform of your choice below.

Our community awaits your uploads - Snap, tag and hashtag away!



**@electriQUK**

**#electriQUK**

# WE'RE HERE TO HELP

---

Should you have any problems or questions with your purchase, please contact a member of our customer service team.

☎ 0330 390 3061

✉ [support@electriQ.co.uk](mailto:support@electriQ.co.uk)

Mon-Fri | 9am to 5pm

Unit J6, Lowfields Business Park,  
Lowfields Way, Elland  
West Yorkshire, HX5 9DA



## CONTENTS

SAFETY INFORMATION	3
WHAT'S INCLUDED	5
MONITOR DIMENSIONS	5
CONNECTIONS AVAILABLE ON THE MONITOR	6
WALL MOUNTING	6
GETTING STARTED	7
INITIAL SET UP	8
MENU OPTIONS	8
LUMINANCE	9
IMAGE SETUP	9
COLOUR SETUP	10
OSD SETUP	10
RESET	11
EXTRA	11
TECHNICAL SPECIFICATION	13
SUPPORT	14

## SAFETY INFORMATION

- Read these instructions - All the safety and operating instructions should be read before this product is operated.
- Keep these instructions - The safety and operating instructions should be retained for future reference.
- Heed all warnings - All warnings on the appliance and in the operating instructions should be adhered to.
- Follow all instructions - All operating and usage instructions should be followed.
- Do not use this equipment near water, or in humid environments - The appliance should not be used near water or moisture e.g. in a wet basement or near a swimming pool.
- Clean only with a dry cloth. Do not use solvents or petroleum-based fluids.
- Do not block any ventilation openings.
- Do not install near any heat sources such as radiators, stoves or other apparatus (including amplifiers) that produce heat.
- Do not tamper with the supplied plug. This plug is a BS1363 standard plug.
- Protect the power cord from being walked on or trapped, particularly at the plug and at the point where it exits from the appliance.
- Only use attachments/accessories specified by the manufacturer.
- Use only with a cart, stand, tripod, bracket or table specified by the manufacturer or sold with the apparatus. When a cart or stand is used, use caution when moving it to avoid any injuries or damage from it tipping over.
- Unplug the apparatus during lightning storms or when unused for long periods of time.
- Refer all servicing to qualified personnel. Servicing is required when the apparatus has been damaged in any way, such as if the power cord or plug is damaged, liquid has been spilled or objects have fallen into the apparatus or it has been exposed to rain or moisture, it does not operate normally or has been dropped.
- Please keep the unit in a well-ventilated environment.
- The monitor should only be connected to a mains power supply as rated on the back of the equipment.
- To prevent overload, do not share the same power socket with too many other electronic components.
- Do not place any connecting wires where they may be stepped on or tripped over.
- Do not place heavy items on the cable as this may cause damage.
- When removing from a socket hold by the plug and not the wires.

- Disconnect the power immediately and seek professional help if the plug or cable is damaged, liquid has spilt onto the unit, if accidentally exposed to water or moisture, if anything accidentally penetrates the ventilation slots or if the unit does not work normally.
- Do not remove the safety covers. There are no user serviceable parts inside. Trying to service the unit yourself is dangerous and may invalidate the product's warranty. Only qualified personnel should service this apparatus.
- Do not block ventilation slots on the back cover. The monitor can be placed in a cabinet but ensure at least 5cm (2") clearance all around. Do not tap or shake the screen, this may damage internal components.
- **WARNING:** To reduce the risk of fire or electric shock, do not expose this apparatus to rain or moisture. The apparatus shall not be exposed to dripping or splashing and objects filled with liquids, such as vases, shall not be placed on the apparatus.
- **WARNING:** The wall socket is used as a disconnection device and should remain readily accessible.
- **WARNING:** The batteries shall not be exposed to excessive heat such as direct sunlight or fire.
- Although every effort is made to maintain the accuracy of the manual, due to continuous product development, some variation from the manual is possible.
- The availability of features and settings may vary depending on the input source and method of connection.
- The available resolutions and refresh rates may be limited by the capabilities and/or settings of the source device.

 <b>AT FULL VOLUME, PROLONGED LISTENING MAY DAMAGE THE USER'S HEARING.</b>		
 <p>This warning sign is to warn of dangerous voltage inside the product.</p>	<div style="border: 2px solid black; padding: 5px; text-align: center;"> <b>CAUTION</b>  <small>RISK OF ELECTRIC SHOCK, DO NOT OPEN</small> </div> <p>CAUTION: To reduce the risk of electric shock, DO NOT remove the cover (or back). No user serviceable parts inside. Refer servicing to qualified service personnel.</p>	 <p>This warning sign is to alert you of important instructions accompanying the product.</p>

# WHAT'S INCLUDED



USER MANUAL

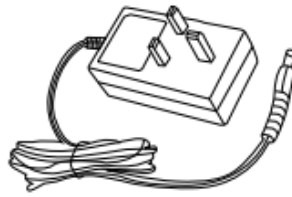

POWER SUPPLY

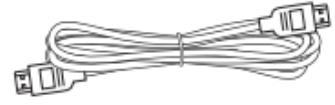

HDMI CABLE

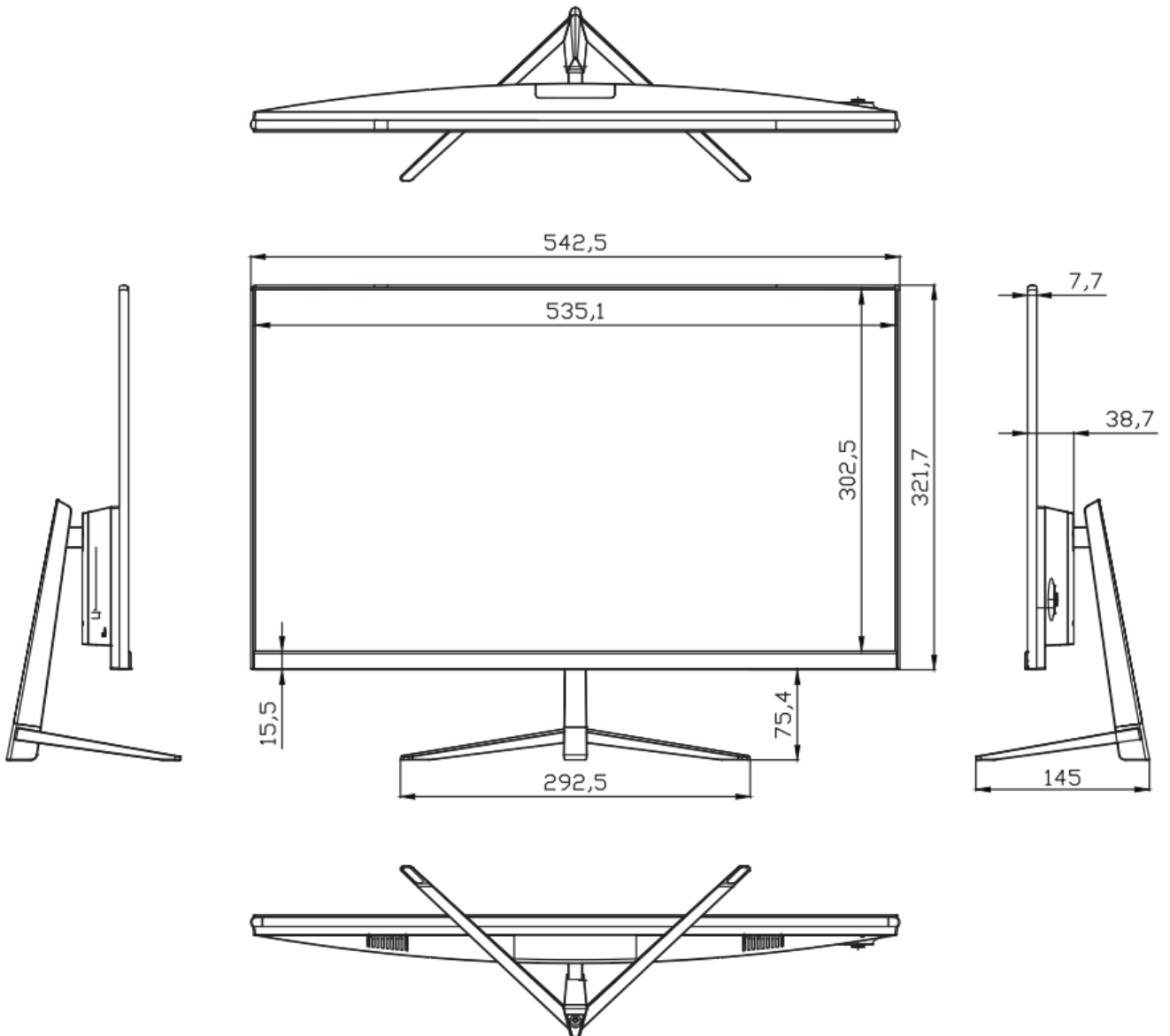

## CONNECTIONS AVAILABLE ON THE MONITOR

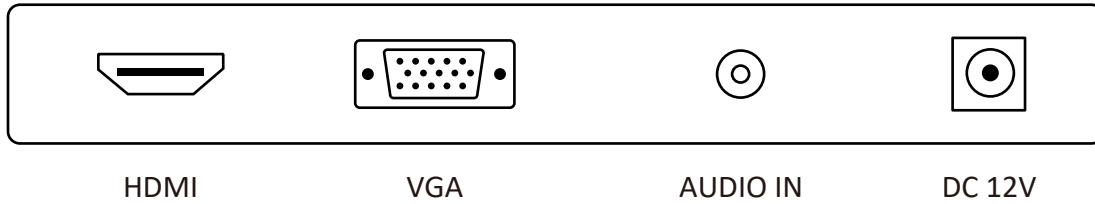

1. HDMI port: Used to connect a compatible device. Supports HDMI 1.4 & 2.0;
2. VGA: Used to connect a compatible VGA device.
3. Audio In: Used for connecting headphones, or external speakers. The audio input is used in conjunction with the VGA input if a HDMI source is in use, the sound will come from the HDMI connection.
4. DC Input Port: Connect the supplied power supply to power the monitor

## WALL MOUNTING

The monitor is provided with mounting holes for a VESA approved wall mounting bracket (not supplied)

The VESA mounting pattern is: 75x75mm and the size of the screws is 4 x M4 x 8 (not supplied)

Do not use screws longer than specified or damage will occur to the internal components.

**NOTE:** As the monitor is considered heavy, please consult with a professional wall mount installer to perform the installation.

## GETTING STARTED

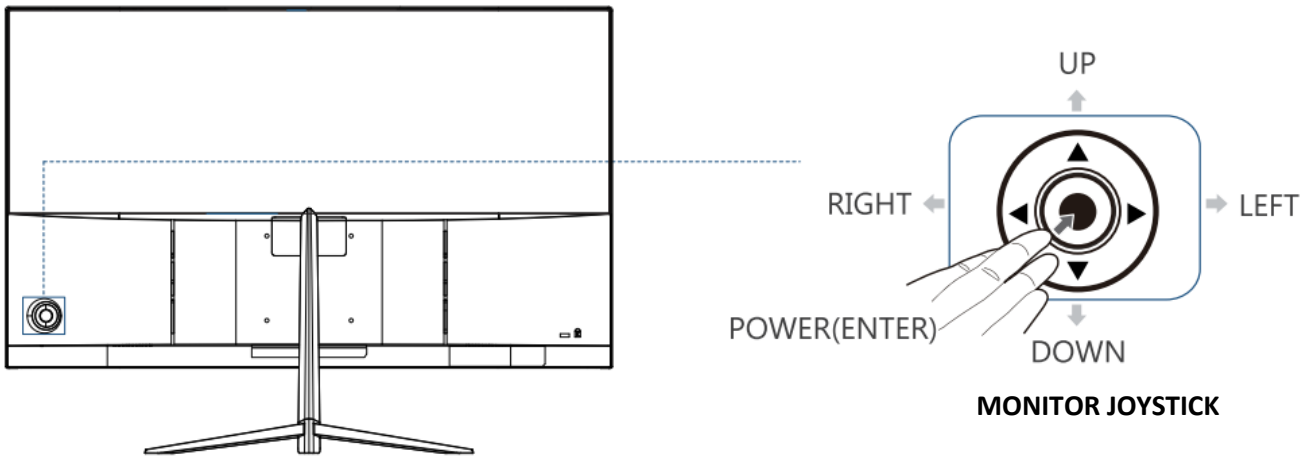

### MONITOR JOYSTICK

The monitor joystick is located on the rear left side of the monitor. The joystick can be used to move up, down, left or right within the menus and pressing the joystick can be used as enter.

When the monitor has no display, the monitor buttons can be used as below:

●	Press once to turn on the monitor when plugged in. When turned on, press again to activate the function guide. Press to confirm the chosen setting.
◀	Select the signal source. Press again to exit.
▶	ECO mode (Standard, Game, Movie, Internet)
▲	Adjust the contrast.
▼	Adjust the brightness.

## INITIAL SETUP

Connect the monitor to a power outlet.

1. Press the POWER button on the monitor to turn it on (The indicator will be blue)
2. Connect the relevant cable to the corresponding input on the monitor. The source will be automatically detected.
3. To change between inputs, press the “◀” button to enter the source menu. Use the “▲” and “▼” buttons to choose the input source between VGA and HDMI.

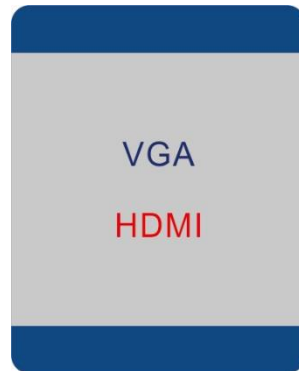

## MENU OPTIONS

The menu for the monitor can be accessed by pressing the joystick on the control panel. This menu is separated into the following sub menus: Luminance, Image Setup, Colour Setup, OSD Setup, Reset and Extra, details of each menu can be found in the following sections.



## LUMINANCE SETTINGS

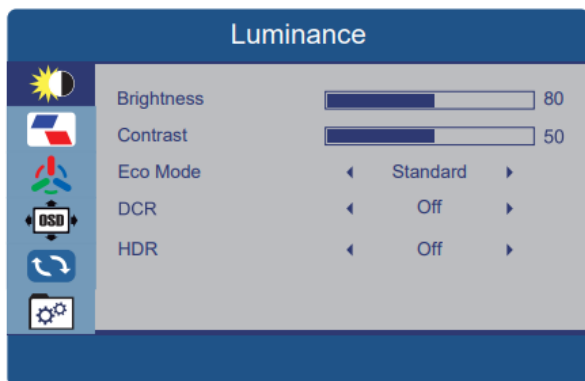

### BRIGHTNESS

Allows the adjustment of the image brightness, according to ambient light in the room between "0-100"

### CONTRAST

Allows the adjustment of contrast between white and black areas of the image between "0-100"

### ECO MODE

Allows selection of image settings between the following: STANDARD, MOVIE, INTERNET and GAME.

### DCR

Allows the dynamic contrast of the picture to be turned ON and OFF

### HDR

Allows the HDR of the picture to be turned ON or OFF.

## IMAGE SETUP SETTINGS

### H. POSITION (VGA ONLY)

Allows adjustment of the horizontal position of the display image. Use the "◀" and "▶" buttons to horizontally move the image.

### V. POSITION (VGA ONLY)

Allows adjustment of the vertical position of the display image. Use the "◀" and "▶" buttons to vertically move the image.

### CLOCK (VGA ONLY)

Allows adjustment of the CLOCK setting between "0-100"

### PHASE (VGA ONLY)

Can reduce video distortion and instability. Adjust between "0-100"

### IMAGE RATIO

Allows the Image Ratio of the picture to be changed between WIDE and 4:3.

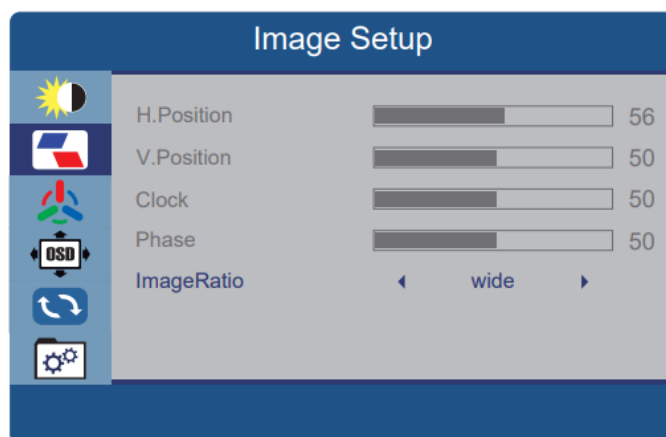

## COLOUR SETUP SETTINGS

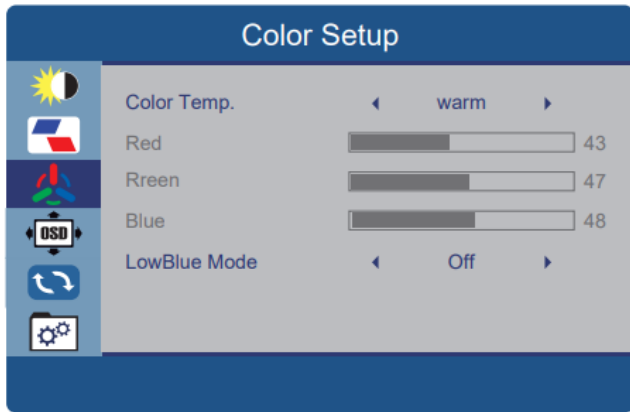

### COLOR TEMP.

Allows adjustment of the colour settings between the following options: Warm, Normal, User and Cool.

### RED

Allows adjustment of the red element of color for the image

### GREEN

Allows adjustment of the green element of color for the image

### BLUE

Allows adjustment of the blue element of color for the image

### LOW BLUE MODE

Allows adjustment of the Low Blue Mode between the following options: OFF, Weak, Medium, Strong.

## OSD SETUP SETTING

### LANGUAGE

Allows selection of desired language

### H. POSITION

Allows adjustment of the horizontal position of the OSD

### V.POSITION

Allows adjustment of the vertical position of the OSD

### TIMEOUT

Allows adjustment of the duration of the OSD between 5 and 100"

### TRANSPARENCE

Allows adjustment of the transparency of the OSD between "0-100".

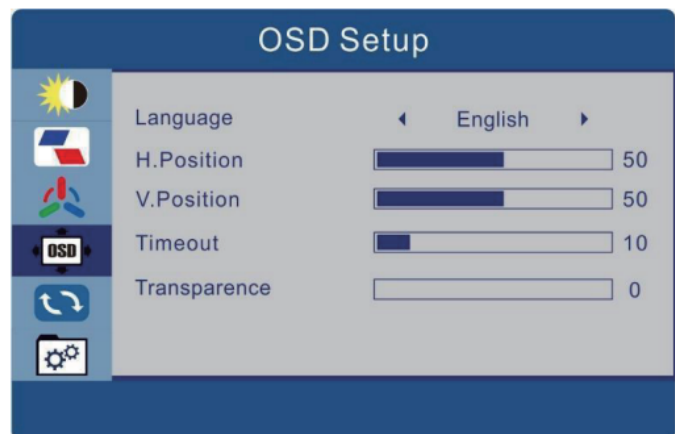

## RESET

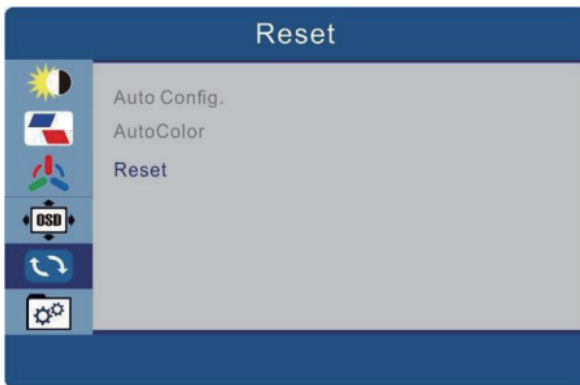

### AUTO CONFIG.

Auto adjusts the image.

### AUTO COLOR

Auto adjusts the colour of the image.

### RESET

Returns the monitor to its factory default settings.

## EXTRA

### INPUT SELECT

Allows user to choose the signal source for the display between "HDMI, VGA".

### MUTE

Allows Mute to be turned ON and OFF

### VOLUME

Allows adjustment of the volume of the monitor from "0-100".

### FREESYNC

Allows Freesync to be turned ON or OFF.

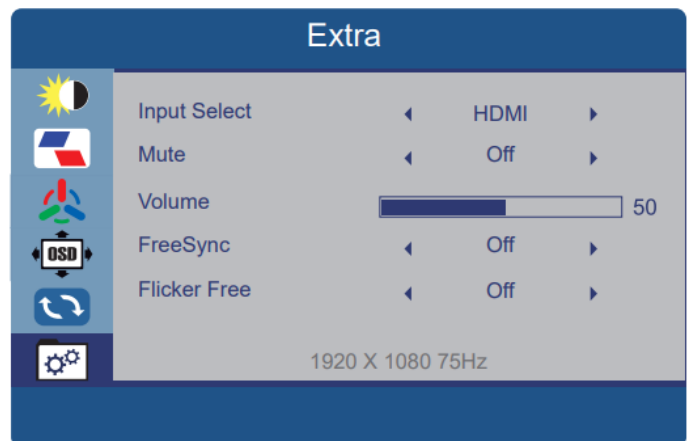

## TROUBLESHOOTING

<b>Problem</b>	<b>Solution</b>
No power	Insert the plug securely into the power outlet.
No picture	Ensure that the equipment is connected properly.
	Ensure the correct input is selected.
No response when buttons are pressed.	Disconnect the power and then reconnect. (The unit may not be operating properly due to lightning, static, or other factors.)
Noise or other interference	Electronic equipment near the unit may be causing interference. Relocate the unit or move the equipment.

## TECHNICAL SPECIFICATION

<b>eiQ-24FHD75IS-V2</b>	
<b>Panel Type</b>	23.8 "
<b>Case Type</b>	Plastic
<b>Best Resolution</b>	1920(H) x 1080(V)
<b>Active Display Area</b>	527.04 (H) X 296.46 (V)
<b>Pixel Pitch</b>	0.2475 (H) x 0.2475 (V)
<b>Contrast Ratio</b>	1000:1 Typical
<b>Brightness</b>	250 cd/m <sup>2</sup>
<b>Response Time</b>	5ms(G2G)
<b>Viewing Angle</b>	U/D: 89° / 89°, L /R: 89° / 89°
<b>Display Colours</b>	16.7M
<b>Adjustable Colour Temperature</b>	WARM / COOL / USER / NORMAL
<b>Video Compatibility</b>	Multi-Standard for NTSC / PAL
<b>Aspect Ratio</b>	16: 9
<b>Speaker Multimedia Speakers</b>	Right x 1 Left x 1, 2 X 3W
<b>Sound Demodulation</b>	Stereo. Audio
<b>Mute</b>	Yes
<b>Operating Humidity</b>	20 % - 70 %
<b>Operating Temperature</b>	- 10 to 40 °C
<b>Wall Mountable</b>	75mm x 75mm
<b>IN/OUT INTERFACE</b>	
<b>Video Interface</b>	HDMI + VGA
<b>Audio Interface</b>	Audio In x 1
<b>Stand Type</b>	Desktop
<b>Button Position</b>	Right Hand Side
<b>Power Voltage</b>	DC12V / 3A
<b>Power Consumption</b>	28W



The terms HDMI and HDMI High-Definition Multimedia Interface, and the HDMI Logo are trademarks or registered trademarks of HDMI Licensing Administrator, Inc. in the United States and other countries.

## ENVIRONMENTAL PROTECTION



Recycling facilities are now available for all customers at which you can deposit your old electrical products. Customers will be able to take any old electrical equipment to participating civic amenity sites run by their local councils. Please remember that this equipment will be further handled during the recycling process, so please be considerate when depositing your equipment. Please contact the local council for details of your local household waste recycling centres.

## electriQ UK SUPPORT

[www.electriQ.co.uk/support](http://www.electriQ.co.uk/support)

Call: 0330 390 3061

Office hours: 9AM - 5PM Monday to Friday

[www.electriQ.co.uk](http://www.electriQ.co.uk)

Unit J6, Lowfields Business Park  
Lowfields Way, Elland  
West Yorkshire, HX5 9DA