

SONY®

Television

Reference Guide

BRAVIA

KDL-60W600B



Table of Contents

Safety Information	2
Precautions	4
Connecting Other Devices.	6
Installing the TV to the Wall	7
Troubleshooting	10
Troubles and Solutions	10
Specifications	11

Introduction

Thank you for choosing this Sony product. Before operating the TV, please read this manual thoroughly and retain it for future reference.

Note

- Before operating the TV, please read "Safety Information" (page 2).
- Instructions about "Installing the TV to the Wall" are included within this TV's instructions manual.
- Images and illustrations used in Quick Start Guide and this manual are for reference only and may differ from actual product appearance.

Location of the identification label

Labels for the Model No., Power Supply rating (in accordance with applicable safety regulation) and Manufacturing date are located on the rear of the TV.

Notice for customers in Thailand

This telecommunication equipment conforms to NTC technical requirement.

Notes for Australia and New Zealand model

This product is ENERGY RATING qualified in the default mode. ENERGY RATING is a programme designed to promote energy efficient products and practices.

- When the TV is initially set up, it is designed to meet ENERGY RATING requirements while maintaining optimum picture quality.
- Changes to certain features, settings and functionalities of this TV (e.g. TV Guide, Picture/Sound, Eco setting) can slightly change the power consumption.

Depending upon such changed settings (e.g. Shop mode), the power consumption may vary which possibly could exceed the stated energy rating.

To reset the TV to ENERGY RATING qualified settings, complete the initial set-up procedure in [Auto Start-up] under the settings menu.

IMPORTANT INFORMATION

If a television is not positioned in a sufficiently stable location, it can be potentially hazardous due to falling. Many injuries, particularly to children, can be avoided by taking simple precautions such as:

- Using cabinets or stands recommended by the manufacturer of the television.
- Only using furniture that can safely support the television.
- Ensuring the television is not overhanging the edge of the supporting furniture.
- Not placing the television on tall furniture (for example, cupboards or bookcases) without anchoring both the furniture and the television to a suitable support.
- Not standing the televisions on cloth or other materials placed between the television and supporting furniture.
- Educating children about the dangers of climbing on furniture to reach the television or its controls.

Safety Information

WARNING

Batteries must not be exposed to excessive heat such as sunshine, fire or the like.

Installation/Set-up

Install and use the TV set in accordance with the instructions below in order to avoid any risk of fire, electrical shock or damage and/or injuries.

Installation

- The TV set should be installed near an easily accessible AC power outlet (mains socket).
- Place the TV set on a stable, level surface to avoid it from falling down and cause personal injury or damage to the TV.

- Only qualified service personnel should carry out wall installations.
- For safety reasons, it is strongly recommended that you use Sony accessories, including:
 - Wall-Mount Bracket SU-WL450
- Be sure to use the screws supplied with the Wall-Mount Bracket when attaching the Wall-Mount Bracket to the TV set. The supplied screws are designed as indicated by illustration when measured from the attaching surface of the Wall-Mount Bracket. The diameter and length of the screws differ depending on the Wall-Mount Bracket model.
 - Use of screws other than those supplied may result in internal damage to the TV set or cause it to fall, etc.

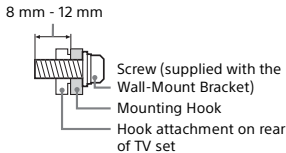

Transporting

- Before transporting the TV set, disconnect all cables.
- Two or three people are needed to transport a large TV set.
- When transporting the TV set by hand, hold it as shown below. Do not put stress on the LCD panel and the frame around the screen.

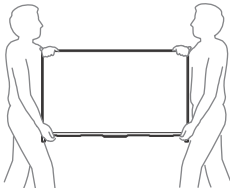

- When transporting the TV set, do not subject it to jolts or excessive vibration.
- When transporting the TV set for repairs or when moving, pack it using the original carton and packing material.

Ventilation

- Never cover the ventilation holes or insert anything in the cabinet.
- Leave space around the TV set as shown below.
- It is strongly recommended that you use a Sony Wall-Mount Bracket in order to provide adequate air-circulation.

Installed on the wall

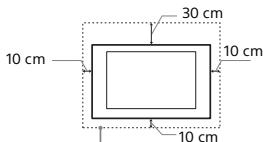

Leave at least this space around the set.

Installed with stand

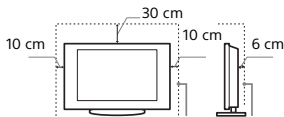

Leave at least this space around the set.

- To ensure proper ventilation and prevent the collection of dirt or dust:
 - Do not lay the TV set flat, install upside down, backwards, or sideways.
 - Do not place the TV set on a shelf, rug, bed or in a closet.
 - Do not cover the TV set with a cloth, such as curtains, or items such as newspapers, etc.
 - Do not install the TV set as shown below.

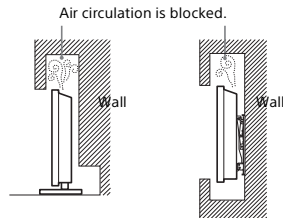

AC power cord (mains lead)

Handle the AC power cord (mains lead) and outlet (mains socket) as follows in order to avoid any risk of fire, electrical shock or damage and/or injuries:

- Insert the plug fully into the AC power outlet (mains socket).
- Operate the TV set on a 110–240 V AC supply only.
- When wiring cables, be sure to unplug the AC power cord (mains lead) for your safety and take care not to catch your feet on the cables.
- Disconnect the AC power cord (mains lead) from the AC power outlet (mains socket) before working on or moving the TV set.
- Keep the AC power cord (mains lead) away from heat sources.
- Unplug the AC power plug (mains plug) and clean it regularly. If the plug is covered with dust and it picks up moisture, its insulation may deteriorate, which could result in a fire.

Note

- Do not pinch, bend, or twist the AC power cord (mains lead) excessively. The core conductors may be exposed or broken.
- Do not modify the AC power cord (mains lead).
- Do not put anything heavy on the AC power cord (mains lead).
- Do not pull on the AC power cord (mains lead) itself when disconnecting the AC power cord (mains lead).
- Do not connect too many appliances to the same AC power outlet (mains socket).
- Do not use a poor fitting AC power outlet (mains socket).

Prohibited Usage

Do not install/use the TV set in locations, environments or situations such as those listed below, or the TV set may malfunction and cause a fire, electrical shock, damage and/or injuries.

Location:

- Outdoors (in direct sunlight), at the seashore, on a ship or other vessel, inside a vehicle, in medical institutions, unstable locations, near water, rain, moisture or smoke.
- If the TV is placed in the changing room of a public bath or hot spring, the TV may be damaged by airborne sulfur, etc.



- For best picture quality, do not expose the screen to direct illumination or sunlight.
- Avoid moving the TV from a cold area to a warm area. Sudden room temperature changes may cause moisture condensation. This may cause the TV to show poor picture and/or poor colour. Should this occur, allow moisture to evaporate completely before powering the TV on.

Environment:

- Places that are hot, humid, or excessively dusty; where insects may enter; where it might be exposed to mechanical vibration, near flammable objects (candles, etc). The TV set shall not be exposed to dripping or splashing and no objects filled with liquids, such as vases, shall be placed on the TV.
- Do not place the TV in a humid or dusty space, or in a room with oily smoke or steam (near cooking tables or humidifiers). Fire, electric shock, or warping may result.
- Do not install the TV in places subject to extreme temperature, such as in direct sunlight, near a radiator or a heating vent. The TV may overheat in such conditions which can cause deformation of the enclosure and/or TV malfunction.

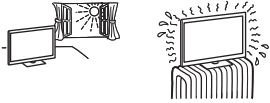

Situation:

- Do not use when your hands are wet, with the cabinet removed, or with attachments not recommended by the manufacturer. Disconnect the TV set from AC power outlet (mains socket) and antenna (aerial) during lightning storms.
- Do not install the TV so that it sticks out into an open space. Injury or damage from a person or object bumping into the TV may result.

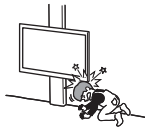

Broken pieces:

- Do not throw anything at the TV set. The screen glass may break by the impact and cause serious injury.
- If the surface of the TV set cracks, do not touch it until you have unplugged the AC power cord (mains lead). Otherwise electric shock may result.

When not in use

- If you will not be using the TV set for several days, the TV set should be disconnected from the AC power (mains) for environmental and safety reasons.
- As the TV set is not disconnected from the AC power (mains) when the TV set is just turned off, pull the plug from the AC power outlet (mains socket) to disconnect the TV set completely.
- However, some TV sets may have features that require the TV set to be left in standby to work correctly.

For children

- Do not allow children to climb on the TV set.
- Keep small accessories out of the reach of children, so that they are not mistakenly swallowed.

If the following problems occur...

Turn off the TV set and unplug the AC power cord (mains lead) immediately if any of the following problems occur. Ask your dealer or Sony service centre to have it checked by qualified service personnel.

When:

- AC power cord (mains lead) is damaged.
- Poor fitting of AC power outlet (mains socket).
- TV set is damaged by being dropped, hit or having something thrown at it.
- Any liquid or solid object falls through openings in the cabinet.

About LCD Monitor Temperature

When the LCD Monitor is used for an extended period, the panel surrounds become warm. You may feel hot when touching there by the hand.

Precautions

Viewing the TV

- View the TV in moderate light, as viewing the TV in poor light or during long period of time, strains your eyes.
- When using headphones, adjust the volume so as to avoid excessive levels, as hearing damage may result.

LCD Screen

- Although the LCD screen is made with high-precision technology and 99.99% or more of the pixels are effective, black dots may appear or bright points of light (red, blue, or green) may appear constantly on the LCD screen. This is a structural property of the LCD screen and is not a malfunction.
- Do not push or scratch the front filter, or place objects on top of this TV set. The image may be uneven or the LCD screen may be damaged.
- If this TV set is used in a cold place, a smear may occur in the picture or the picture may become dark. This does not indicate a failure. These phenomena disappear as the temperature rises.
- Ghosting may occur when still pictures are displayed continuously. It may disappear after a few moments.
- The screen and cabinet get warm when this TV set is in use. This is not a malfunction.
- The LCD screen contains a small amount of liquid crystal. Follow your local ordinances and regulations for disposal.

Handling and cleaning the screen surface/ cabinet of the TV set

Be sure to unplug the AC power cord (mains lead) connected to the TV set from AC power outlet (mains socket) before cleaning. To avoid material degradation or screen coating degradation, observe the following precautions.

- To remove dust from the screen surface/cabinet, wipe gently with a soft cloth. If dust is persistent, wipe with a soft cloth slightly moistened with a diluted mild detergent solution.
- Never spray water or detergent directly on the TV set. It may drip to the bottom of the screen or exterior parts and enter the TV set, and may cause damage to the TV set.



- Never use any type of abrasive pad, alkaline/acid cleaner, scouring powder, or volatile solvent, such as alcohol, benzene, thinner or insecticide. Using such materials or maintaining prolonged contact with rubber or vinyl materials may result in damage to the screen surface and cabinet material.
- Periodic vacuuming of the ventilation openings is recommended to ensure to proper ventilation.
- When adjusting the angle of the TV set, move it slowly so as to prevent the TV set from moving or slipping off from its table stand.

Optional Equipment

Keep optional components or any equipment emitting electromagnetic radiation away from the TV set. Otherwise picture distortion and/or noisy sound may occur.

Wireless Function of the unit

- Do not operate this unit near medical equipment (pacemaker, etc.), as malfunction of the medical equipment may result.
- Although this unit transmits/receives scrambled signals, be careful of unauthorised interception. We cannot be responsible for any trouble as a result.

Caution about handling the remote control

- Observe the correct polarity when inserting batteries.
- Do not use different types of batteries together or mix old and new batteries.
- Dispose of batteries in an environmentally friendly way. Certain regions may regulate the disposal of batteries. Please consult your local authority.
- Handle the remote control with care. Do not drop or step on it, or spill liquid of any kind onto it.
- Do not place the remote control in a location near a heat source, a place subject to direct sunlight, or a damp room.

Disposal of the TV set



Disposal of Old Electrical & Electronic Equipment (Applicable in the European Union and other European countries with separate collection systems)

This symbol is on the remote control.

GB

Connecting Other Devices

To connect with an HDMI cable

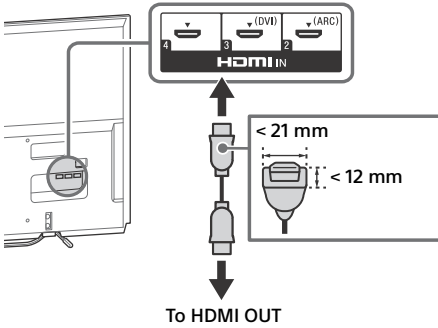

To connect with AV composite cables

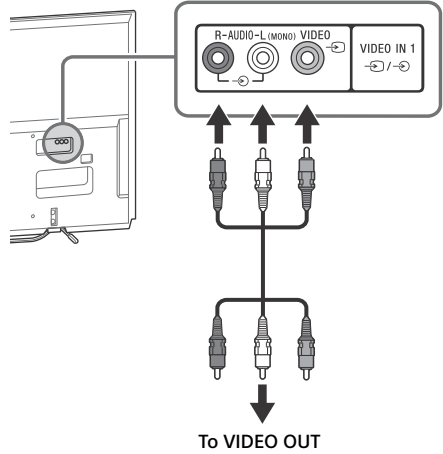

To connect with component cables

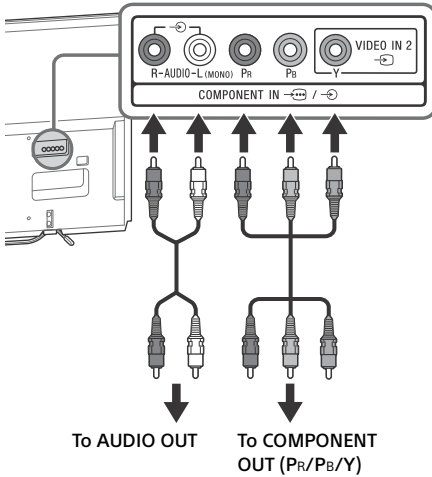

Picture Quality

- AV composite cable
- Antenna (aerial) cable
- Component cable
- HDMI cable



Standard definition (SD) videos have picture signals with a vertical resolution of 480 (NTSC) or 576 (PAL/SECAM) lines.



High definition (HD) videos have picture signals with a vertical resolution of 720 or 1,080 lines.

Installing the TV to the Wall

This TV's instruction manual only shows the steps on preparing the installation of the TV before installing to the wall.

To Customers:

For product protection and safety reasons, Sony strongly recommends that installation of your TV be performed by Sony dealers or licensed contractors. Do not attempt to install it yourself.

To Sony Dealers and Contractors:

Provide full attention to safety during the installation, periodic maintenance and examination of this product.

Sufficient expertise is required for installing this product, especially to determine the strength of the wall for withstanding the TV's weight. Be sure to entrust the attachment of this product to the wall to Sony dealers or licensed contractors and pay adequate attention to safety during the installation. Sony is not liable for any damage or injury caused by mishandling or improper installation.

Use the Wall-Mount Bracket SU-WL450 (not supplied) to install the TV to the wall. When installing the Wall-Mount Bracket, also refer to the Operating Instructions and Installation Guide supplied with the Wall-Mount Bracket.

Note

- Be sure to store the removed screws in a safe place, keeping them away from children.

- 1 Make sure that the wall has enough space for the TV and is capable of supporting a weight of at least four times that of the TV. Refer to the following table on installing the TV to the wall. See page 11-13 (Specifications) for the TV's weight.

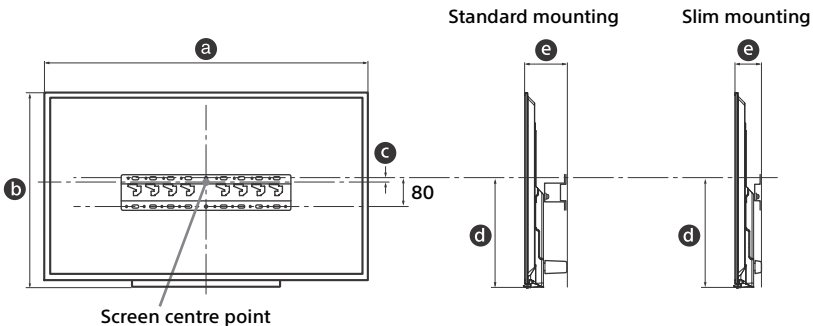

Unit: mm

Model Name	Display dimensions		Screen centre dimension	Length for mounting	
	a	b	c	d	e
KDL-					
60W600B	1,370	811	6	423	Standard mounting: 146 Slim mounting: 104

Note

- Figures in the table may differ slightly depending on the installation.
- When your TV is installed on the wall, the upper side of the TV slightly leans forward.

2 Attach the Attachment parts for Wall-Mount Bracket. Check the Attachment parts by referring to "1" of the Wall-Mount Bracket Installation Guide.

Note

- If using an electric screwdriver, set the torque at approximately 1.5 N·m (15 kgf·cm).
- Be sure to store the unused parts in a safe place for future use. Retain this manual for future reference.

Standard mounting

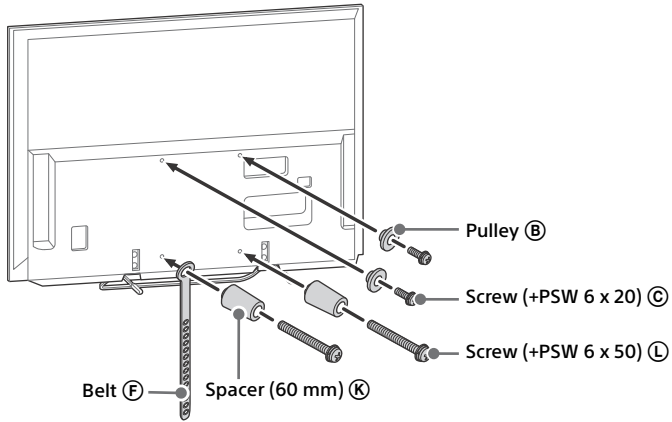

Slim mounting

Note

- You cannot use some of the terminals on the rear of the TV when using this mounting style.

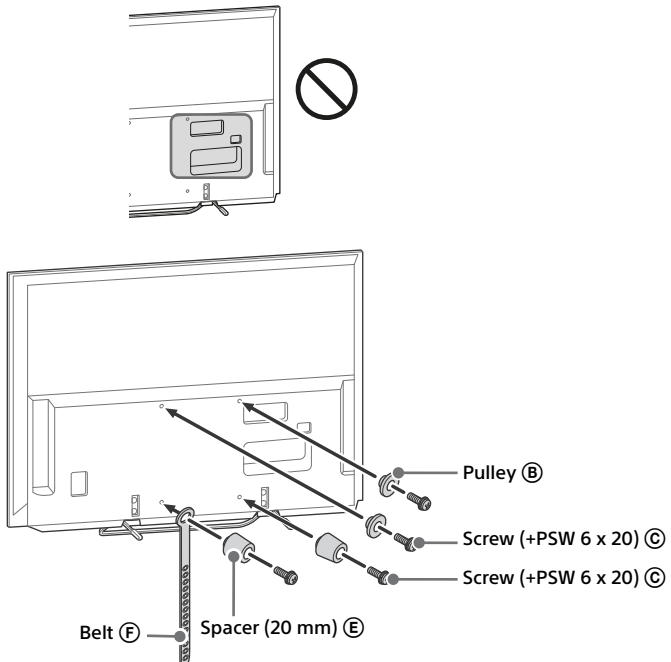

3 Connect necessary cables to the TV.

Note

- You cannot access to any terminal after installing the TV to the wall.

4 Detach the Table-Top Stand from the TV.

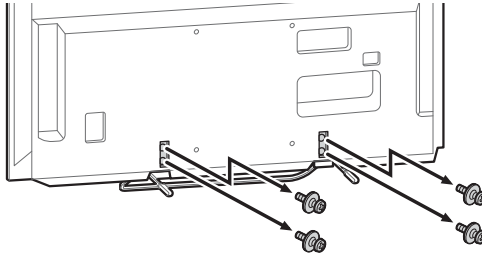

5 Install the TV to the Base. Refer to "5" of Installation Guide and "Installing the TV to the Wall" of Operating Instructions supplied with the Wall-Mount Bracket.

Model Name KDL-	Hook location
60W600B	b

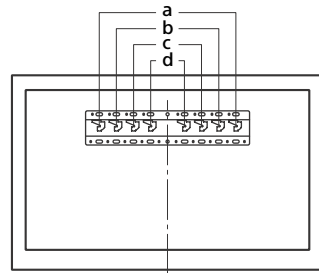

Refer to the instructions supplied with the Wall-Mount Bracket for your model to install the TV on the wall.

Troubleshooting

When the illumination LED is flashing red, count how many times it flashes (interval time is three seconds).

If the illumination LED flashes red, reset the TV by disconnecting the AC power cord (mains lead) from the TV for two minutes, then turn on the TV.

If the problem persists, contact your dealer or Sony service centre with the number of times the illumination LED flashes red (interval time is three seconds). Press **I/⏻** on the TV to turn it off, disconnect the AC power cord (mains lead), and inform your dealer or Sony service centre.

When the illumination LED is not flashing, check the items as follows.

You can also refer to [Troubleshooting] in the i-Manual or perform self-diagnosis by selecting **? [Help]** → **🔧 [Customer Support]** → **[Self Diagnostics]**. If the problem persists, have your TV serviced by qualified service personnel.

Troubles and Solutions

There is no picture (screen is dark) and no sound.

- Check the antenna (aerial)/cable connection.
- Connect the TV to the AC power (mains), and press **I/⏻** on the TV or remote control.

Some programmes cannot be tuned.

- Check the antenna (aerial).

The remote control does not function.

- Replace the batteries.
- Your TV may be in SYNC mode.
Press **SYNC MENU**, select [TV Control] and then select [Home (Menu)] or [Options] to control the TV.

The [Parental Lock] password has been forgotten.

- Enter 9999 for the PIN code. (PIN code 9999 is always accepted.)

The TV surrounds become warm.

- When the TV is used for an extended period, the TV surrounds become warm.
You may feel hot when touching there by the hand.

Frozen audio or video, a blank screen, or the TV does not respond to TV or remote control buttons.

- Perform a simple reset of the TV by unplugging the AC power cord (mains lead) for two minutes, then plug it in again.

The **I/⏻**, **CH+/-**, **⏪ +/-**, **⏩ +/-**, **⏮**, **⏭** and **HOME** buttons cannot be located on the TV.

- See below illustration for location of the buttons on the TV.

Rear of TV

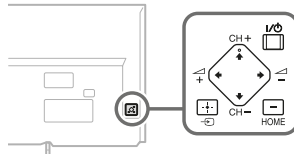

The illumination LED is turned on.

- If you do not wish to light up the illumination LED, you can turn it off.
Press **HOME**, then select **⚙️ [Settings]** → **⌘ [System Settings]** → **[General Set-up]** → **[Illumination LED]** → **[Off]**. You can also press **OPTIONS**, then select **[Illumination LED]** → **[Off]**.

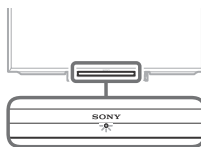

Cannot connect to a wireless router by WPS.

- If you use WEP security, select **[Easy]** → **[Wi-Fi]** → **[Connect by scan list]**. Then, select the network name (SSID) you want to connect.

Cannot find the required network name in network setup.

- Select **[Manual Entry]** and press **⊕** to enter network name.

Specifications

System

Panel system

LCD (Liquid Crystal Display) Panel, LED Backlight

TV system

Analogue: B/G, I, D/K, M, L

Digital: DVB-T/DVB-T2

Colour/video system

Analogue: PAL, SECAM, NTSC3.58, NTSC4.43

Digital: Refer to the i-Manual

Channel coverage

Analogue: UHF/VHF/Cable, Depending on your country/area selection.

Digital: UHF/VHF, Depending on your country/area selection.

Sound output

10 W + 10 W

Wireless technology

Protocol IEEE802.11a/b/g/n

Input/Output jacks

Antenna (aerial)/cable

75 ohm external terminal for VHF/UHF

/ VIDEO IN 1

Video/Audio input (phono jacks)

/ COMPONENT IN

YPbPr (Component Video): 1080p (50, 60 Hz), 1080i (50, 60 Hz), 720p (50, 60 Hz), 576p, 576i, 480p, 480i

Audio input (phono jacks)

VIDEO IN 2

Video input (common phono pin with Y input)

HDMI IN 1, 2, 3, 4

Video (2D): 1080p (30, 50, 60 Hz), 1080/24p, 1080i (50, 60 Hz), 720p (30, 50, 60 Hz), 720/24p, 576p, 576i, 480p, 480i, PC Formats

Video (3D):

Frame Packing: 1080p (30 Hz), 1080/24p, 1080i (50, 60 Hz), 720p (30, 50, 60 Hz), 720/24p
Side-by-Side: 1080p (50, 60 Hz), 1080/24p, 1080i (50, 60 Hz), 720p (50, 60 Hz)
Over-Under: 1080p (30, 50, 60 Hz), 1080/24p, 1080i (50, 60 Hz), 720p (50, 60 Hz)

Audio: 5.1 channel linear PCM: 32, 44.1 and 48 kHz, 16, 20 and 24 bits, Dolby Digital

ARC (Audio Return Channel) (HDMI IN 2 only)

MHL (common with HDMI IN 1)

Video (2D): 1080p (30 Hz), 1080/24p, 1080i (50, 60 Hz), 720p (30, 50, 60 Hz), 720/24p, 576p, 576i, 480p, 480i

Video (3D):

Side-by-Side: 1080/24p, 1080i (50, 60 Hz), 720p (50, 60 Hz)

Over-Under: 1080p (30 Hz), 1080/24p, 1080i (50, 60 Hz), 720p (50, 60 Hz)

Audio: 5.1 channel linear PCM: 32, 44.1 and 48 kHz, 16, 20 and 24 bits, Dolby Digital

DIGITAL AUDIO OUT (OPTICAL)

Digital optical jack (Two channel linear PCM, Dolby Digital)

HDMI 3 AUDIO IN

Analogue audio input (stereo mini jack)

AUDIO OUT /

Audio output (stereo mini jack)

Headphone jack

(supports Subwoofer out)

Ψ 1, Ψ 2 (Except Australia and New Zealand model)

USB port

Ψ 1 (HDD REC), Ψ 2 (Australia and New Zealand model only)

USB HDD device port (Ψ 1 only), USB port

LAN

10BASE-T/100BASE-TX connector (Depending on the operating environment of the network, connection speed may differ. 10BASE-T/100BASE-TX communication rate and communication quality are not guaranteed for this TV.)

Others

Optional accessories

Wall-Mount Bracket: SU-WL450

Camera and Microphone: CMU-BR200/
CMU-BR100

Wireless Subwoofer: SWF-BR100

MHL Cable: DLC-MB10/DLC-MB20/DLC-MC10/
DLC-MC20/DLC-MC30

Operating temperature

0 °C – 40 °C

Operating humidity

10 % – 80 % RH (non-condensing)

Power and others

Power requirements

110 V - 240 V AC, 50/60 Hz

Screen size (measured diagonally) (Approx.)

60 inches / 152.5 cm

Display resolution

1,920 pixels (horizontal) × 1,080 lines (vertical)

Power consumption

Indicated on the rear of the TV

Dimensions (Approx.) (w × h × d)

with Table-Top Stand

1,370 × 846 × 230 mm

without Table-Top Stand

1,370 × 811 × 84 mm

Mass (Approx.)

with Table-Top Stand

20.5 kg

without Table-Top Stand

19.9 kg

Note

- Optional accessories availability depends on countries/region/TV model/stock.
- Design and specifications are subject to change without notice.
- This TV set incorporates MHL 2.

Notes on Digital TV function

- Any functions related to Digital TV (**DVB**) will only work in countries or areas where DVB-T/DVB-T2 (MPEG-2 and H.264/MPEG-4 AVC) digital terrestrial signals are broadcast. Please confirm with your local dealer if you can receive a DVB-T/DVB-T2 signal where you live.
- This TV set complies with DVB/DVB-T2 specifications, but compatibility with future DVB/DVB-T2 digital terrestrial broadcasts are not guaranteed.
- Some Digital TV functions may not be available in some countries/areas.

Trademark information

- The terms HDMI and HDMI High-Definition Multimedia Interface, and the HDMI Logo are trademarks or registered trademarks of HDMI Licensing LLC in the United States and other countries.
- DLNA®, the DLNA Logo and DLNA CERTIFIED® are trademarks, service marks, or certification marks of the Digital Living Network Alliance.

- Manufactured under license from Dolby Laboratories. Dolby and the double-D symbol are trademarks of Dolby Laboratories.
- “BRAVIA” and BRAVIA are trademarks of Sony Corporation.
- TrackID is a trademark or registered trademark of Sony Mobile Communications AB.
- Gracenote, Gracenote eyeQ, Gracenote VideoID, Gracenote Video Explore, Gracenote MusicID, the Gracenote logo and logotype, and the “Powered by Gracenote” logo are either registered trademarks or trademarks of Gracenote in the United States and/or other countries.
- Opera® Devices SDK from Opera Software ASA. Copyright 1995-2014 Opera Software ASA. All rights reserved.
- Wi-Fi, Wi-Fi Direct and Miracast are trademarks or registered trademarks of Wi-Fi Alliance.
- “Sony Entertainment Network logo” and “Sony Entertainment Network” are trademarks of Sony Corporation.
- MHL, Mobile High-Definition Link and the MHL Logo are trademarks or registered trademarks of MHL Licensing, LLC.
- For DTS patents, see <http://patents.dts.com>. Manufactured under license from DTS Licensing Limited. DTS, the Symbol, & DTS and the Symbol together are registered trademarks, and DTS Digital Surround is a trademark of DTS, Inc. © DTS, Inc. All Rights Reserved.
- Designed with UEI Technology™ Under License from Universal Electronics Inc. Portions © UEI 2000 – 2013





GB





Customer Support and Contact:

<http://www.sony-asia.com/support>

<http://www.sony.net/>

©2014 Sony Corporation Printed in Malaysia



* 4 5 3 7 3 9 4 1 1 * (1)

4-537-394-11(1)