

24" Dual Drawer Outdoor Wine and Beverage Fridge

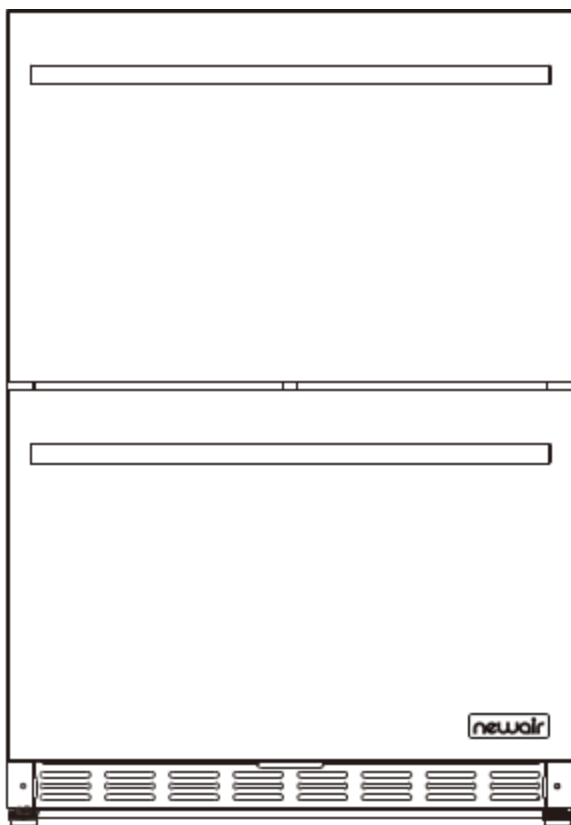

OWNER'S MANUAL

Read and save these instructions.



Intertek
Manual v1.0

READ AND SAVE THESE INSTRUCTIONS.

TABLE OF CONTENTS

Register Your Product Online.....	3
Safety Information & Warnings	4
Assembly & Installation	6
Operating Your Fridge.....	11
Cleaning & Maintenance.....	12
Limited Manufacturer's Warranty	13

SPECIFICATIONS

MODEL NO.	NOF100SS00
VOLTAGE:	110-120V
CURRENT:	1.3A
FREQUENCY:	60Hz
POWER CONSUMPTION:	110W
STORAGE CAPACITY:	4.1 cubic feet
TEMPERATURE RANGE:	Upper Zone: 46-64F Lower Zone: 32-42F
REFRIGERANT:	R600a

REGISTER YOUR PRODUCT ONLINE

Register Your NewAir Product Online Today!

Take advantage of all the benefits product registration has to offer:



Service and Support

Diagnose troubleshooting and service issues faster and more accurately



Recall Notifications

Stay up to date for safety, system updates, and recall notifications



Special Promotions

Opt-in for NewAir promotions and offers

Registering your product information online is safe & secure and takes less than 2 minutes to complete:

newair.com/register

Alternatively, we recommend you attach a copy of your sales receipt below and record the following information, which is located on the manufacturer's nameplate on the rear of the unit. You will need this information if it becomes necessary to contact the manufacturer for service inquiries.

Date of Purchase: _____

Serial Number: _____

Model Number: _____

SAFETY INFORMATION & WARNINGS

Your safety and the safety of others is very important.



We have provided many important safety messages in this manual and on your appliance. Always read and obey all safety messages. This is the Safety Alert Symbol. The symbol alerts you to potential hazards that can kill or injure you and others. All safety messages will follow the Safety Alert Symbol and

either the word **DANGER** or **WARNING**.

DANGER means that failure to heed this safety statement may result in severe personal injury or death.

WARNING means that failure to heed this safety statement may result in extensive product damage, serious personal injury, or death.

All safety messages will alert you about the potential hazard, tell you how to reduce the chance of injury, and let you know what can happen if the instructions are not followed.

IMPORTANT SAFEGUARDS

Before the appliance is used, it must be properly positioned and installed as described in this manual, so please read the manual carefully. To reduce the risk of fire, electrical shock or injury when using the appliance, follow basic precautions, including the following:

DANGER

- Plug into a grounded 3 prong outlet, do not remove grounding prong, do not use an adapter, and do not use an extension cord.
- It is recommended that a separate circuit serving only your appliance be used. Do not use outlets that can be turned off by a switch or pull chain.
- Never clean appliance parts with flammable fluids. These fumes can create a fire hazard or explosion.
- Do not store or use gasoline or other flammable vapors and liquids in the vicinity of this or any other appliance. The fumes can create a fire hazard or explosion.
- Do not connect or disconnect the plug when your hands are wet.
- Unplug the appliance or disconnect power before cleaning or servicing. Failure to do so can result in electrical shock or death.

- Do not attempt to repair or replace any part of your appliance unless it is specifically recommended in this manual. For any further issues, please contact customer service at support@newair.com.

WARNING 

- Keep ventilation openings, in the appliance enclosure or in the built-in structure, clear of obstruction.
- Do not damage the refrigerant circuit.
- Do not use electrical appliances inside the food storage compartments of the appliance, unless they are of the type recommended by the manufacturer.
- When positioning the appliance, ensure the supply cord is not trapped under the unit or damaged in any way.
- Do not use power strips or portable power supplies behind the appliance.

Attention: Child Entrapment Risk!

There is a child entrapment risk for refrigerators and other appliances which are to be discarded or are in storage. The surest method to prevent child entrapment is to take off the door completely. In most cases, this is a simple process using a screwdriver. It is unlawful in many local jurisdictions to discard old refrigerators without first removing the door.

Keep children away from refrigerators, freezers, dryers or coolers still in use. Lock doors to prevent access to these appliances (especially when children are unsupervised) and warn children not to play on, with or inside these appliances.

- SAVE THESE INSTRUCTIONS -

ASSEMBLY & INSTALLATION

Initial Setup



Before connecting the fridge to the power source, let it stand upright for approximately 24 hours.

This will reduce the possibility of a malfunction in the cooling system from handling during transportation.

Once you have plugged the unit into an electrical outlet, let the unit run for at least 30 minutes to acclimate before making any adjustments.

BEFORE YOU START

Your fridge was designed to store a maximum number of bottles and cans securely. We recommend that you observe the tips below to optimize loading:

- Remove tape from shelves once unit is stable and ready for storage.
- Make sure that the weight of the bottles/cans between the top and bottom drawers is roughly the same, to prevent tipping.
- Never pull out both drawers at the same time—always close one drawer before opening the other.

The fridge should be placed in a location where the ambient temperature is between 61°-109°F (16°-43°C). If the ambient temperature is outside this range, the cooling performance of the fridge may be negatively affected. For example, placing your unit in extremely cold or hot conditions may cause interior temperatures to fluctuate more often.

OPTIONAL ANTI-TIP BRACKET INSTALLATION

This unit comes with optional anti-tip brackets that help prevent sliding or tipping. If you want to install them, follow these instructions:

1. You can use one (or both) of the anti-tip brackets. Brackets are meant to be screwed into the floor for the back adjustable feet of the fridge to slide and lock into.
2. If using both brackets, place the brackets on the floor and position them in their final location before securing them to the floor with screws. Brackets should be $22\frac{1}{4}$ inches (565mm) apart between each center of bracket (red dots in each bracket below). Make sure the brackets are lined up with each other so that both back feet can slide into them equally. You may find it helpful to measure the distance between the centers of the two back feet, just to be safe.

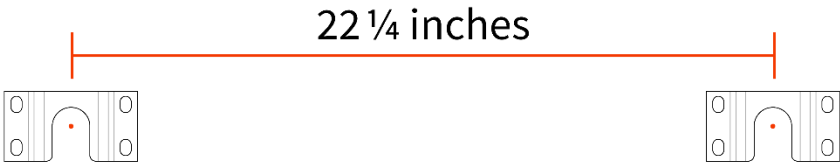

3. Please note: the brackets will stick out under the sides of the fridge once installed, but not the back. Use the graphic below as a reference, in case it affects your final placement.

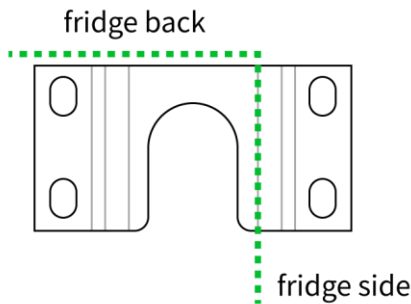

4. While the brackets are in position on the floor, mark the position of all 4 holes on each bracket. **Before drilling any holes, double check all measurements and place the fridge near the brackets to check your accuracy. Bracket openings should line up with the adjustable feet on the back of the unit.** Use a $5/16$ drill bit to make holes for the plastic anchors. Insert the plastic anchors.

5. Once plastic anchors are in place, use the screws to secure the brackets in place. Alternate turning all four screws on each bracket to prevent the bracket from moving too much from the original location.
6. Lift the unit to access the adjustable feet at the back. Use a screwdriver to remove the two screws between the feet and the back of the unit. If these are not removed, they will prevent the feet from sliding into the brackets.

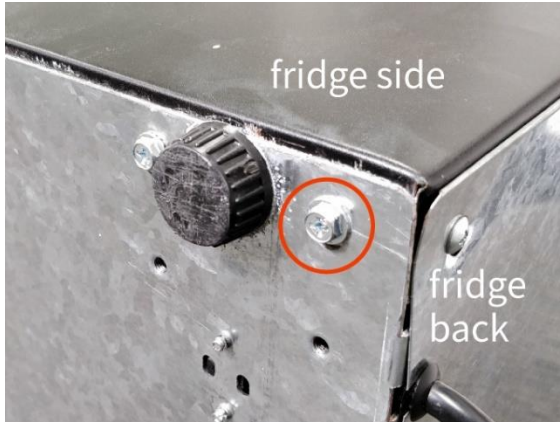

7. Loosen the adjustable feet so that they can slide under the brackets. If the feet won't slide into the brackets, adjust them either direction until the bracket can pass between the top of the adjustable foot and the bottom of the fridge.

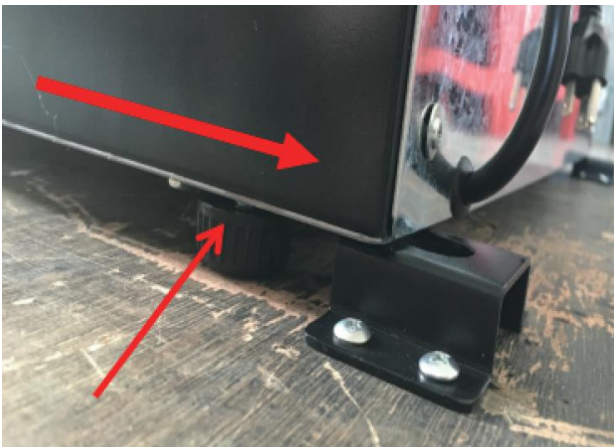

INSTALLING THE HANDLE

Press the included screws through the openings on the inside of each drawer so that they show through the front of the drawer. Line up the handle with the screws, and screw them in. Alternate turning each screw so the handle doesn't end up crooked. **DO NOT OVERTIGHTEN**, as you could damage the drawer. Seriously, don't do it.

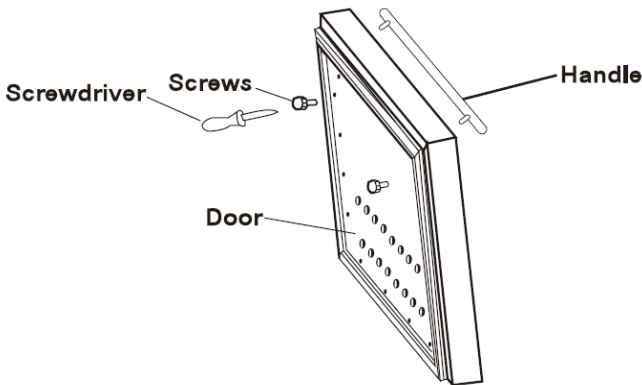

ELECTRICAL REQUIREMENTS

- Make sure to use a compatible power outlet (115 volts/15 amps) with proper grounding to power the fridge.
- Do not cut off the third grounding prong or use three-prong adapters in order to power the fridge. This is very dangerous since it provides no effective grounding for the fridge and may result in a shock hazard.
- Avoid installing the unit on circuits which may also have other high amperage appliances in use. This unit is best used on a dedicated circuit.
- Avoid the use of an extension cord because of potential safety hazards under certain conditions. If it is necessary to use an extension cord, use only a 3-wire extension cord that has a 3-blade grounding plug and a 3-slot outlet compatible with the plug. The marked rating of the extension cord must be equal to or greater than the electrical rating of the fridge.
- If there is ever a power outage, unplug the unit until power is restored. Once restored, wait 3-5 minutes, then plug in your fridge again.

INSTALLATION OPTIONS

- This unit can be installed under a counter or between cabinets, but it must be positioned so that the vent at the bottom of the front of the unit is free from obstruction. Allow for $\frac{1}{4}$ inch of clearance on all sides (and the top) and 1 inch of clearance at the back to prevent issues with proper airflow.
- Select a suitable location for the fridge on a hard, even surface, away from direct sunlight or heat sources such as radiators, baseboard heaters, cooking appliances, etc. Accommodate any uneven floors by adjusting the feet at the bottom of the unit.
- While this fridge can be installed under a counter or between cabinets, it is perfectly usable as a freestanding unit as well.

OPERATING YOUR FRIDGE

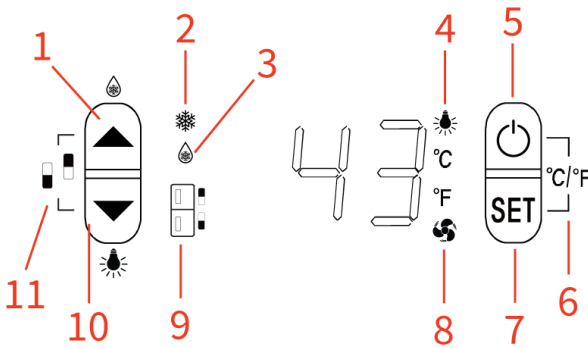

1. Temperature increase and defrost on/off button (this button will only adjust the temperature if the temperature adjustment button is selected first. Otherwise, it will change the defrost setting.) Press and hold this button for 6 seconds to manually enable/disable defrosting mode.
2. "Cooling Active" indicator light (indicates that the compressor is running)
3. "Defrost Active" indicator light
4. "Lights On" indicator light
5. Power button (press and hold to turn the unit on or off without having to unplug the power cord)
6. °F and °C switch icon (press and hold both buttons to change from F to C)
7. Temperature adjustment button (press once to adjust temperature for selected drawer). Once your temperature is selected, the display will flash the selected temperature for 5 seconds, then revert back to displaying the ambient temperature.
 - a. Upper Zone Temperature Range: 46-64F
 - b. Lower Zone Temperature Range: 32-42F
 - c. If you unplug the fridge while it's running, or if there is a power outage, your control panel will remember your settings and revert to them once power is restored.
8. "Evaporator Active" indicator light
9. "Selected Drawer" indicator light (indicates which drawer is selected for temperature adjustment)
10. Temperature decrease and lighting on/off button (this button will only adjust the temperature if the temperature adjustment button is selected first. Otherwise, it will change the light setting.) Press this button once to enable/disable the interior lights.
11. Selected Drawer switch icon (press and hold both buttons to switch the selected drawer for temperature adjustment).

CLEANING & MAINTENANCE

WARNING: To avoid electrical shock, always unplug your fridge before cleaning. Ignoring this warning may result in injury or death.

CAUTION: Before using cleaning products, always read and follow manufacturer's instructions and warnings to avoid personal injury or product damage.

- Use a sponge or soft cloth, dampened with warm water and a mild detergent, to wipe down the inside and outside of your fridge.
- Dry off your fridge thoroughly with a soft cloth. Allow to dry completely before restoring power to the unit.
- If you ever notice any mold inside your fridge, use the above instructions to clean it off.
- Do not use harsh chemicals, abrasives, ammonia, chlorine bleach, concentrated detergents, solvents or metal scouring pads. Some of these chemicals/materials may dissolve, damage and/or discolor your fridge.
- Clean the gaskets on the doors every three months according to the above instructions, to help maintain a proper seal.

LONG-TERM STORAGE

- For long vacations or absences, unplug the fridge, defrost and clean it thoroughly. Leave both drawers open to ensure no moisture builds up inside.
- When moving the fridge, always leave it upright. Moving the unit on its back or sides may damage interior parts. After moving, leave unit standing upright 24 hours before plugging it in.

LIMITED MANUFACTURER'S WARRANTY

This appliance is covered by a limited manufacturer's warranty. For one year from the original date of purchase, the manufacturer will repair or replace any parts of this appliance that prove to be defective in materials and workmanship, provided the appliance has been used under normal operating conditions as intended by the manufacturer.

Warranty Terms:

During the first year, any components of this appliance found to be defective due to materials or workmanship will be repaired or replaced, at the manufacturer's discretion, at no charge to the original purchaser. The purchaser will be responsible for any removal or transportation costs.

Warranty Exclusions:

The warranty will not apply if the damage is caused by any of the following:

- Power failure
- Damage in transit or when moving the appliance
- Improper power supply such as low voltage, defective household wiring or inadequate fuses
- Accident, alteration, misuse or abuse of the appliance such as using non-approved accessories, inadequate air circulation in the room or abnormal operating conditions (extreme temperatures)
- Use in commercial or industrial applications
- Fire, water damage, theft, war, riot, hostility or acts of God such as hurricanes, floods, etc.
- Use of force or damage caused by external influences
- Partially or completely dismantled appliances
- Excess wear and tear by the user

Obtaining Service:

When making a warranty claim, please have the original bill of purchase with purchase date available. Once confirmed that your appliance is eligible for warranty service, all repairs will be performed by a NewAir™ authorized repair facility. The purchaser will be responsible for any removal or transportation costs. Replacement parts and/or units will be new, remanufactured or refurbished and is subject to the manufacturer's discretion. For technical support and warranty service, please email support@newair.com