

SURVEIL

PYLE

PyleUSA.com



PLDVRCAMAND75

Wireless Android Dashcam GPS Navigation Kit

Wireless Bluetooth Android Dashcam
GPS Navigation Device Data Recorder

Before using this product , be sure to read and fully understand the following safety information:

- Do not operate the product while driving, if doing so will divert your attention in any way from the safe operation of your vehicle. Always observe safe driving rules and follow all existing traffic regulations. If you experience difficulty in operating this product or reading the display, park your vehicle in a safe location and apply the parking brake before making the necessary adjustments.
- The company is not accountable for any issues or problems due to the illegal use of this product.
- The driver is prohibited to use the product including: radio, Bluetooth at gas station.
- The seller is not legally authorized to carry out the installation or removal of the product. The company shall not take any responsibility for any consequences resulting from the self - opening of the product.
- The company shall not take any responsibility for any consequences resulting from unboxing the product.



Real-time navigation



wireless online



play music



Speeding alarm



CONTENTS

Note that matters	3
Product Overview	4
Basic Function	4
Quick Guide	7
System Main Interface	8
Navigation	8
Frequency Modulation (FM) Launch	8
Bluetooth Phone	8
Traffic Video (DVR)	9
Setting	9
Voice Command	12
Multimedia Entertainment	14
Installation Map	18
Troubleshooting	19

MATTERS NEEDING ATTENTION

1. When you turn on your navigation device, the GPS receiver must collect satellite data and establish the current location. The time required to acquire satellite signals varies based on several factors, including how far you are from the location where you last used your navigation device, whether you have a clear view of the sky, and how long it has been since you last used your navigation device. The first time you turn on your navigation device, it may take several minutes to acquire satellite signals.
 - Turn on the device.
 - Wait while the device locates satellites.
 - If necessary, go to an open area away from tall buildings and trees.
2. When the product is located in the building, tunnel or around a tall barrier, the system will be temporarily unable to provide you with the positioning and navigation services. Generally, it takes at least 4 satellite signals bars to complete the GPS positioning. If the weather is not good or have dense obstacles, in a building this may affect the reception of satellite signals.
3. Due to traffic or construction, navigation of electronic map data and actual traffic directions may appear. In all cases, you must follow the road status, site signs and other traffic rules. The company does not assume any responsibility of traffic accidents and other various losses due to the misuse of the product.
4. Do not the use this product outside of the power line standard. Do not bend or squeeze power line by heavy force, to avoid short circuit, fire or other accidents.
5. Software upgrades or update may cause may result to some interface, functions and specifications change without notice.
6. This manual has been carefully checked, but does not rule out the possibility of undiscovered errors. Please contact department of the company for any notice.
7. The picture in this manual is for reference only.

PRODUCT OVERVIEW

This product adopts high performance master control program of quad core processor, 16GEMMC+1GDDR, master Control chip built-in GPS, Wi-Fi and Bluetooth, before and after the dual camera, Android5.0 operating system.

Basic Function Introduction

1. Driving Video / Reverse Video:

Front 1080P HD camera, rear view 480P camera; double video display; lock collision shadow; automatic circulation cleaning; Micro SD Memory Card supported.

2. GPS Navigation:

System preset IGO navigation map (offline support map) Real-time road traffic support voice commands); users can also download and install other personal favorite navigation softwares.

3. Bluetooth:

After the initial pairing, the two devices can connect automatically each time you turn them ON. When your phone is connected to your device, you are ready to receive calls.

4. 3G Internet:

This product supports 3G traffic data online, you can achieve online navigation, online music player, Parking remote monitoring and other functions.

5. FM Transmitter Function:

Built-in FM emission function, after pairing with your car speaker, the voice will output with car speaker, give you a more wonderful driving experience. when the car dvr sets up the same FM frequency as car radio (eg.87.9), dvr will output the radio via FM transmitter function to your car speaker.

6. Multimedia Entertainment:

You can watch or play multimedia files using Micro SD Memory Card

7. Voice Control Operation:

Voice commands facilitate the experience and can help you to concentrate on your driving and focus your attention on the road and traffic situation. Voice control allows you to voice-activate certain functions in the multimedia system.

8. Mobile APP Control:

Users can download the phone APP and use through the mirror settings / application interface two-dimensional code Vehicle assistant.

9. System Upgrade:

Upgrade through Micro SD Memory Card.



side



back



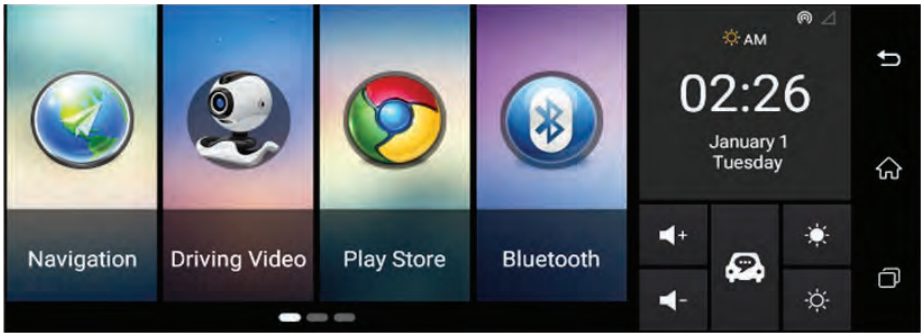

QUICK GUIDE

Power On and Shutdown

The device will power ON automatically; when the system is in a state of dormancy or short press "**Back Light / Power**" button.

Key Wake System

Power ON/OFF the ACC, the system will automatically pops up the "dormant countdown" prompt box. When the countdown is done the system will automatically shuts down; long press "**Back Light / Power**" button to display "**Restart / Hibernation**" then select "**Sleep**" option to allow the system to enter a state of dormancy and shuts down.

The Power Button Function

Boot: Dormant state car ignition 2 seconds to boot.

Shutdown (sleep) or restart:

Long press the power button for 2 seconds the boot state will pop up.

The operation of the dialog box options.

Turn off the screen or light screen: While on boot state; short press to switch the device to three modes (bright, dark, off screen)

Driving Video Recorder (DVR needs to insert Micro SD Memory Card)

In order to allow the system to automatically start capturing driving video, before starting ensure that it has been inserted in the standard Micro SD Memory Card Slot; boot and then insert Micro SD Memory Card card, the system will automatically start capturing driving video.

In order to ensure the normal driving operation system of the video and the Micro SD Memory Card must meet the following specifications:

- The high speed Micro SD Memory Card should be SDHC compatible and reaches C10 level
- Micro SD Memory Card capacity: 8~32GB

No Micro SD Memory Card, video traffic will not work; but can be used as normal camera preview screen.

- Can also use the automatic reverse image (reverse signal access to normal)

SYSTEM MAIN INTERFACE

- Equipment boot, will automatically enter the main interface (desktop), from here you can enter the other functional interface.
- Also displays the related functional status, such as: system time information, DVR video, Bluetooth, Wi-Fi, FM
- Other states (depending on whether the system is using these features)

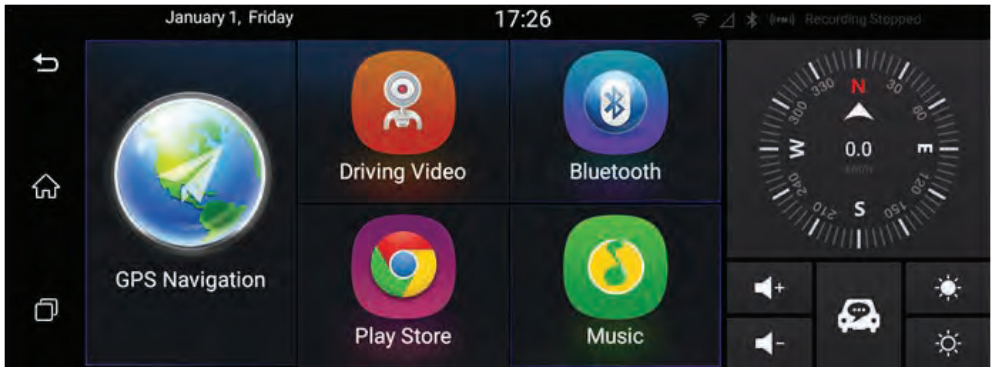

Main interface of the function icon

NAVIGATION

Click on the main interface of the "**Navigation**" button, the system has set up a High German navigation; high navigation support offline map, High German online map host must be connected to the network to use, only the High German online navigation in order to support the system



BLUETOOTH PHONE

Click on the main interface of the "Bluetooth" button; enter the Bluetooth phone interface, for initial use. It is recommended to change the master Bluetooth device name, to easily distinguish between Bluetooth devices; and then the phone to open the Bluetooth, search specified name of the host Bluetooth device that can be used after the connection; once the Bluetooth connection is successful, it will prompt to request phone to download the address book, please click on the phone to sync.

PLAY MUSIC

Click on the main interface of the "**music**" button, you can enter the music application interface to display more music information. You can also play music using control button on the console directly to play music, select up and down other basic functions.

VIDEO PLAYBACK

Click on the main interface  Button to enter the video preview interface, and then click on the top right  button to enter the video file to view and playback; or from the "application" to find "video playback" for viewing and playback.

SETTINGS

Click on the "**Settings**" button on the main interface, you can set the relevant settings for the machine, such as driving recorder.

The Micro SD Memory Card files management: can be managed from the "**advanced**" option in the Android standard.

SET INTERFACE

The default setting is able to meet most of the system.

The video is set in the "**parking automatic sleep**" and "**allow collision awoken**" option, with suggestions. The user can enable the user according to the actual needs.

Other functions, such as the connection File Browser, Wi-Fi view files, use the gallery to view video and pictures, browse the web pages, and so on, are in line with the default Android operating habits.

TWO, TRAFFIC RECORDING (DVR)

Is important to prevent accidental damage or video data loss that are automatically cleaned or covered. Please backup your files.



VIDEO IMAGE FILE

Before or after boot insert Micro SD Memory Card, the system will automatically starts double video camera before and after

- Any time can be suspended from the main interface or a driving video button (if enabled), enter the video traffic

VIEW VIDEO PREVIEW SCREEN

Driving video preview screen supports double preview on front, rear camera single screen preview.

SUPPORT OVERLAY TIME WATERMARK.

- In order to save power, the preview screen will exit timing (the length can be set in the DVR settings).

SUPPORT THE LOCK

- Collision process (traffic video image can be preset, collision strength) (collision) when the body was shaking, Automatically lock the image files of the 20S before and after the collision, the file will not be saved because of short video cycle and because of the relative lack of Micro SD Memory Card space, the system will overwrite the locked images earlier.

Remove files to free up space to continue recording (the system functions Micro SD Memory Card inserted)

- **PARKING MONITORING:** if the user settings in the DVR enabled collision wake-up function, then stop the dormant period
- If a collision (collision sensitivity can be set), the system will automatically wake up, recording 30S Frequency, again automatically enter the sleep to save the vehicles battery (do not shutdown or insert Micro SD Memory Card).

This feature will not be available.

- Any reversing signal received under the host computer, display will start automatically after the camera (cf. Examination of Figure 4); reversing, reversing a security cordon, according to the actual distance of the vehicle manual

Adjust the visual distance of the safety warning line; after the reverse signal disappears, the rear camera automatically exits.

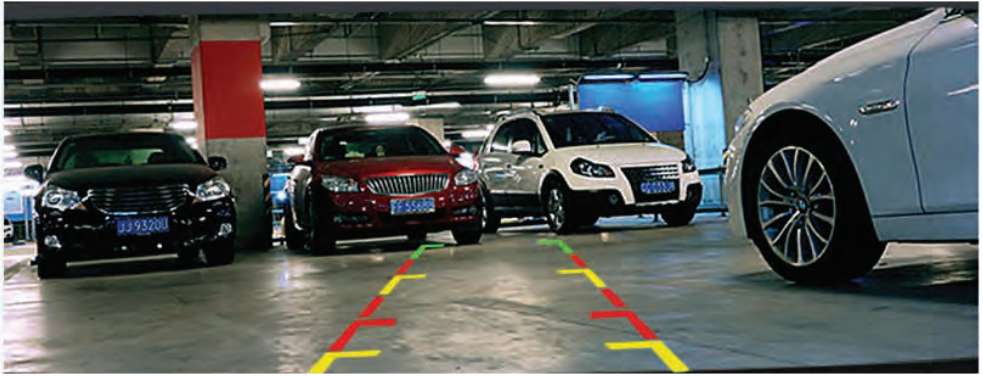



Schematic diagram of the rear view

Front camera video quality can be selected high (1080P) or ordinary (720P); You can choose a sound recording video or mute microphone host.

VIDEO FILE PLAYBACK:

There are two ways to view the current video file playback:

1. You can click on the main interface of the "DVR preview" button, travel video preview interface, click on the right angle button.
: enters a list of video files. Here, the user can choose the video Time, before / after / double video files; you can delete the selected files. Click on a file, call the video player will jump to the specified time to start playing position on the main interface.
2. Click button, enter the system application list interface, and then click play. Here you can directly select the pre / post DVR file playback; in the playback interface can support the playback gesture.
3.  lock the video file is divided into "**can be recycled video files**" and "**lock files**" (recorded order)

The front camera video files "**F**" to start and begin time; to name after the camera. Header of the video file to "**B**" to start and add the recording start time to name.

According to the available capacity of the Micro SD Memory Card, the earlier video files may have been circulating recording function.

First click on the main interface of the navigation button, the system will enter the current system default navigation applications; According to the navigation system will show the current host installed all navigation applications for user selection.

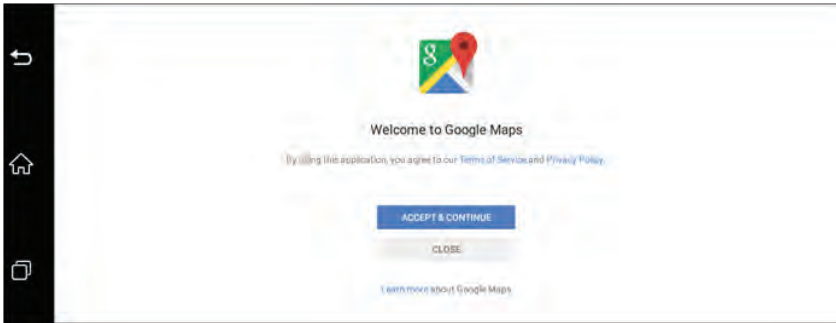

Navigation software interface

BLUETOOTH PHONE

First click on the main interface button; will automatically enter the "**Bluetooth settings**" interface

- recommend users to modify the equipment of the machine to facilitate the search and check the name of Bluetooth
- on your Bluetooth mobile phone, go to "**Bluetooth interface settings**"
- If you need to connect other Bluetooth devices, please click "**Re pairing**"

If the pairing is completed, it is recommended to select the address book and allows the simultaneous use of the machine to facilitate the "language in the mobile phone terminal

VOICE COMMAND FUNCTION (such as: answer, hang up, etc.)

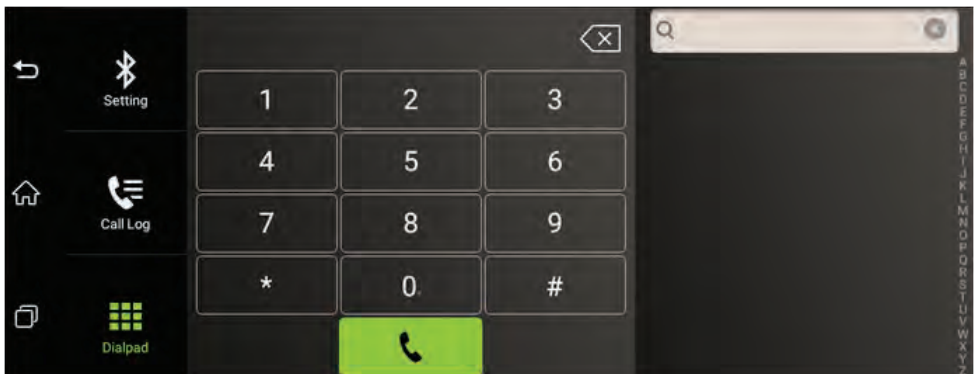

Bluetooth phone configuration

- this machine does not support Bluetooth Headset mode.
- **Warning:** in the running process of manual operation and you really need to use the phone, use the Voice commands to call.

BT Switch

- Name of connected Bluetooth device
- Bluetooth status
- Modify the native Bluetooth name
- Bluetooth name of the machine
- Ignore the current connection
- Bluetooth device, re open
- Initial pairing

FM (FM) LAUNCH

- click on the main interface of the "FM icon" button; enter the system "FM launch" interface (below)
- Click on the FM icon to open the FM launch function, the host side of the horn will mute the user. The radio frequency FM can be adjusted to the machine "FM launch". At the same frequency, your car radio can listen to the sound output of the host at this time; The main interface FM launch status icon will be lit.
- If the FM emission is turned on, click Close FM to turn off the FM transmitter function, the sound will be re emitted from the host's speakers.
- When the host FM is enabled you can adjust the emission frequency of FM

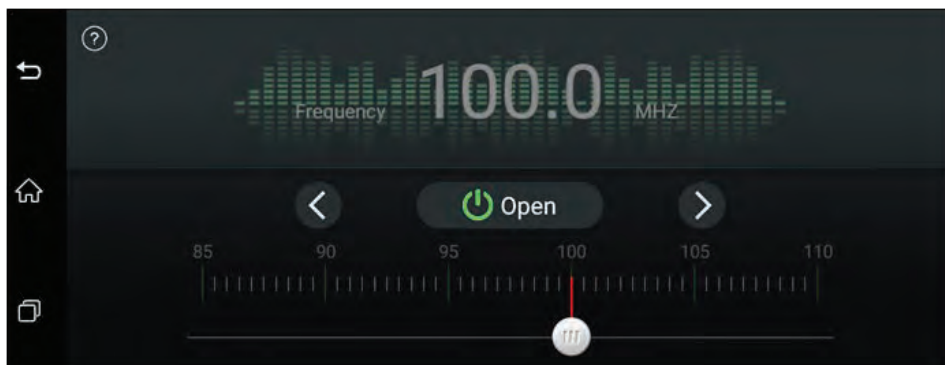

MULTIMEDIA ENTERTAINMENT

- Click on the main interface of system in music button, and enter the music player interface.
- If you need to play video or pictures, click on the video from the main interface picture button, enter the application interface, start Gallery; or through the "document management"
- Find the corresponding multimedia files, click to start.

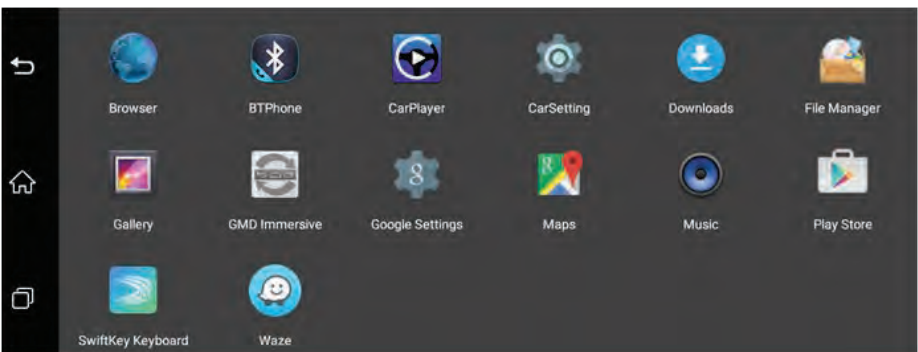
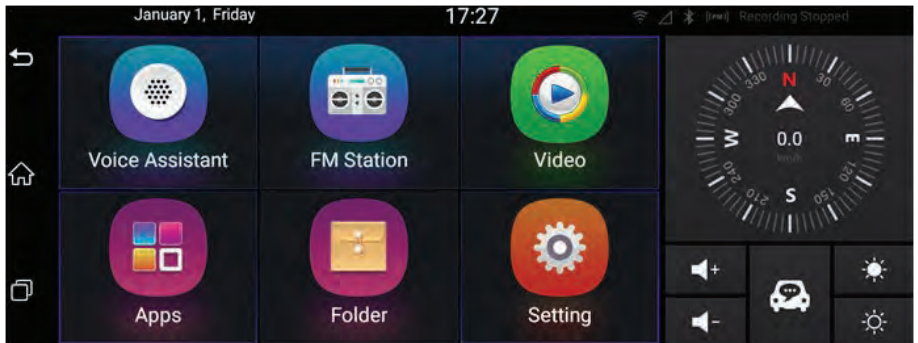
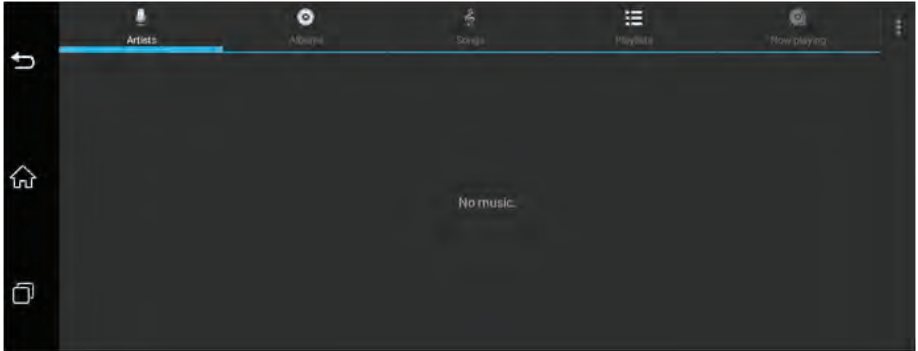

- Click on the main interface of the "**Settings**" button. Here you can adjust the volume, screen brightness, time etc. To enter the Wi-Fi interface, scan or connect to an APP or mobile phone through tachograph settings into video interface settings related to traffic.
- Advanced options to access more settings such as: language, backup and reset.

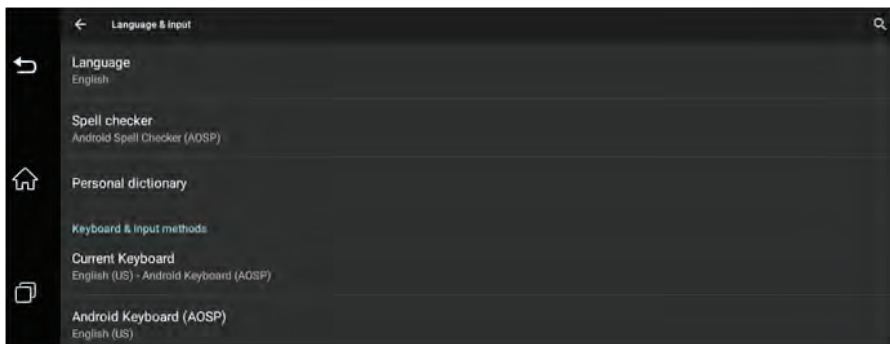
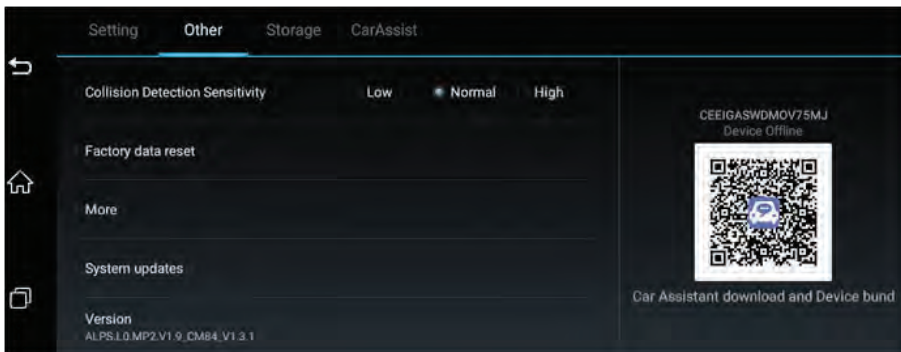

Set (DVR Micro SD Memory Card Management)

In order to prevent the non lock files it is necessary to shut the door on vibration caused by the proposed check automatically delete the earlier movie file lock option, otherwise it easily lead to video file storage cycle length. When the system is slow or the video effect is not good, you can try to format the SD card.

In the video settings interface, you can set the video and related options, such as: front camera video quality (1080p or 720p), video and other conventional options are silent.

There are some special options, as follows:

The Automatic Sleep: It is recommended to choose "**parking 15 minutes**", to ensure that when the device is not in normal sleep, the host will be the two time dormancy to protect your car.

The Collision: Allow wake checked, so that when your car is parked after encountering large collision, it can automatically start 30 seconds of video at any time, to guard your car.

The Automatic Exit Preview: recommended for 30 seconds, so as not to disperse driving attention, also can save power consumption.

MOBILE CLIENT - CAR ASSISTANT

Particularly the development of Internet and mobile phone client mobile phone equipment. You can monitor and manage using your mobile phone remote in real-time. Refer to the specific functions of the client,

"The operating instructions of the vehicle assistant"

SAFE TRAVEL RECORDS CAPTURE ARTIFACT

Function Introduction: Vehicle management and monitoring by mobile phone. Use the internet to capture the video cut rider's interactive sharing car life in real-time.

Conditions and Product Association

1. System version of the Android system in more than 4 of the smart terminal or apple system terminal.
2. Purchase the use of the company's terminal equipment.
3. Download and install



Installation Instructions

1. Ensure that the vehicle is in a power off state
2. Remove the original car host and host support and then the navigation recorder host and host frame fixed in the original car windshield.
3. BMW will be transferred to the line and the external transfers line to the good and then extend the line along the car windshield edge into the car to the car.
4. The host side of the original car line is divided into 4

B+ (Yellow line)



Open the box when the car is not turned on, using a DC block test with a million 12V voltage that is connected to the (B+)

ACC+ (Red line)



Open the box, in the start of the state of the car (do not start when the voltage is 0V) with a DC block test with a 12V voltage at the (ACC+).

GND (Black line)



Open the safe box around the iron to find a reliable ground source to connect (GND)

Reverse Control Line (Red line)



Open rear end case, find the position of the back lamp joint. Start the car, hang reverse gear (R) gear, 12V voltage; neutral (N) to the end of the 0V line connected (reverse control line)

INSTALLATION SKETCH MAP:

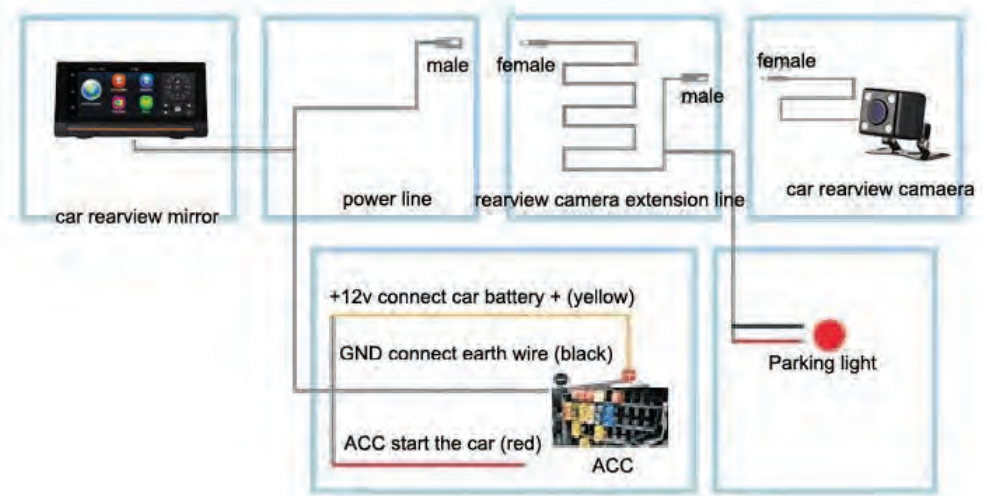

A: Main device **B: ACC fuse box** **C: Rear lamp** **D: Reversing camera**

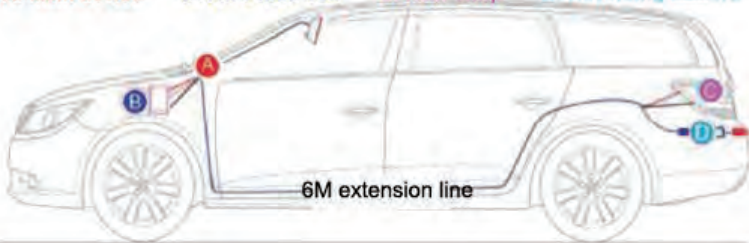

Note: The above 4 lines should be correctly connected to the host to avoid problems.

Note: Only A7 special type of car is above the power supply wiring, A6 is a generic type of rearview mirror, power supply mode is inserted in the cigarette lighter car charger to the power supply, do not need to pick up 1.2.3 points mentioned above mentioned connection mode.

5. Start the engine and check if the machine has been installed correctly.
6. Adjust the camera position, ensure that the lens picture recording center, and check the basic functions of the navigation star search, FM launch, rear view etc..

COMMON TROUBLESHOOTING

If your product does not work properly, please do the following method. If you still cannot rule out the problem, please contact our customer service center.

Question: The Navigation is not working

Cause:

1. No map, no signal, no GPS;
2. When in the process of upgrading the navigation, if the Micro SD Memory Card is removed, the map will be lost.

Solution:

1. Change the map in the Micro SD Memory Card or reinstall the same map data APK and software
2. Upgrade the navigation software
3. Reconnect the network

Question: Record function not working

Cause:

1. Micro SD Memory Card is broken or didn't inserted properly to the card slot
2. The Micro SD Memory Card's "lock file" is already saturated

Solution:

1. Please use Class 10 Micro SD Memory card or change the memory card
2. Reformat the Micro SD Memory Card.

Question: Recording file get stucked

Cause:

1. The Micro SD Memory Card speed is low
2. Micro SD Memory Card Non-Genuine or corrupted

Solution:

1. Do not use lower than Class 8 Micro SD Memory Card, please use Class 10 memory card.
2. Reformat the Micro SD Memory Card or replace a new memory card.

Question: Noisy Radar speed measurement

Cause:

When driving through many traffic lights in the city or driving along with high-profile vehicle that have anti-collision radar;

Solution:

Turn off the Radar speed measurement, turn down the volume or keep away from high-profile vehicle that have anti-collision radar

Question: Can't use Voice Assistant

Cause:

1. The device is not connected with the internet
2. BT call status

Solution:

1. Connect the device to the internet
2. Finish the BT call (Bluetooth call)

Question: Low Voice nonrecognition or recognition rate

Cause:

1. A lot of noise in the car or you're far away from the device
2. Tire pressure noise interference when driving fast.
3. Voice deviate from system recognition voice instruction

Solution:

1. Please follow the voice instruction and don't do any command
2. Turn down the car volume
3. Please speak clearly

Question: No FM sound

Cause:

Mute button is ON or the FM-transmitter is open

Solution:

Increase the volume or turn off the FM-transmitter

Question: There's sound even though the screen is closed

Cause:

Close the screen or go to sleep mode;

Solution:

Short press power switch switch back to day mode

Question: System stops working

Cause:

Not normal operation

Solution:

1. Please press the "Reset" switch.
2. Long press power switch for 3 seconds and choose reboot
3. Go to " setting" —"other"—"restore factory setting"

Question: Dim and hazy recorded video

Cause:

1. The camera lens or car Glass is dirty
2. The camera angle is not suitable

Solution:

1. Keep the camera lens and car glass clean
2. Adjust the camera angle, not too much lower or higher
3. Please double check, if the camera lens protective film is out

Question: The device is working slowly

Cause:

Too many software or APP working in the background or too much downloaded or installed third-party software

Solution:

1. Close the software and APP that you are not using
2. Uninstall some third-party software to clear more system space
3. Reboot

FEATURES:

- Dual Camera Video Recording System
- Video Recording DVR: Save Video from Both Cameras
- Front Dash Cam: 1080p Dashboard Mount Cam
- Rear Backup Cam: 720P Compact Exterior Mount Rearview Bumper Cam
- PiP (Picture-in-Picture) On-Screen Dual Cam Viewing
- Ability to Snap Pictures & Record Video
- GPS Navigation System with Data Recorder
- Includes All Necessary Cables/Wires for Installation
- Android Quad Core Computer
- Wi-Fi Connectivity Support
- Bluetooth Hands-Free Call Answering
- 7" inch Touch Screen Display
- Built-in Rechargeable Battery
- Micro SD Memory Card Reader
- Digital Media File Playback
- 16GB Internal Storage Memory
- FM Radio Receiver
- Angle Adjustable Tilting Screen
- Parking Surveillance Mode: Automatic Power-On & Record Function

ANDROID OS COMPUTER:

- Touchscreen 'Tablet-Style' Functionality
- Wi-Fi Wireless Streaming Connectivity
- Search & Surf the Web, Download Apps
- Browse the Google Play Store
- Multi-Touch Capacitive Display Screen
- 3G WiFi Mobile HotSpot Capability
- Processor: Quad Core 1.3 Ghz
- OS Version: Android 5.0 (Lollipop)

WIRELESS BLUETOOTH CONNECTIVITY:

- Hassle-Free Pairing, Simple Music Streaming
- Built-in Microphone for Hands-Free Calling
- Compatible with All of Today's Latest Bluetooth Devices (Smartphones, Tablets, Laptops, Computers, etc.)
- Bluetooth Version: 4.0
- Bluetooth Network Name: 'SURVEIL'
- Wireless Range: Up to 32' ft.

WHAT'S IN THE BOX:

- Dash-Cam Monitor
- Rearview Backup Camera
- GPS Antenna
- Car Charger
- Power Wiring Harness

TECHNICAL SPECS:

- Screen Resolution: 1280 x 480 Pixels
- Video System: PAL/NTSC Auto Switching
- Angle Adjustable Tilting Screen: 45° Degree
- Backup Camera Resolution: 420 TV Lines
- Image Sensor: 1/4" Color CMD
- Supports HD Multimedia Video MP3, MP4, FLASH Play, RMVB
- Rechargeable Battery: 3.7V Lithium, 800mah (2.96wh)
- Camera Power Cord Length: 19.6' ft.
- Power: DC 12V (USB 5V, 2A)
- Camera Dimensions (L x W x H): 0.91" x 0.91" x 0.91" -inches
- Monitor Dimensions (L x W x H): 7.60" x 3.15" x 3.94" -inches
- Sold as: Unit

PYLE

PyleUSA.com



VISIT US ONLINE:

Have a question?

Need service or repair?

Want to leave a comment?

PyleUSA.com/ContactUs

PYLE