

vapour^{M4S}

HYBRID FLOOR STEAMER



All in One Steam Cleaner

INSTRUCTION MANUAL

Before using this product, please read the instructions and keep it for future references.

IMPORTANT: SAVE THESE INSTRUCTIONS

SAFETY WARNING

- This appliance is not intended for use by persons (including children) with reduced physical, sensory, mental capabilities or lack of experience and knowledge unless they have been instructed to do so by a person responsible for their safety.
- Children should be cautioned that the steamer is not a toy and should not be played with.
- Keep the appliance out of reach of children when it is plugged in or cooling down.
- If the electrical cord is damaged, it must be replaced by the manufacturer, its service agent or similarly qualified person in order to avoid a hazard.
- The steam released from the appliance is extremely hot. Both appliance and accessory tools may scald. Avoid direct contact. The steam symbol  warns operators that there is the risk of scalding!
- Never open the safety cap while using the device.
- Unscrew the safety cap only when the device is switched off, pressure-free and cooled.

ETY INSTRUCTION

- This appliance is not to be used if it has been dropped, if there are visible signs of damage or if it is leaking.
- Disconnect the appliance from the electrical outlet prior to any maintenance or cleaning operations. Always allow the appliance to completely cool down.
- Do not leave the appliance unattended while it is connected to the electrical outlet. Unplug the plug if you need to get away even just for a few minutes.

IMPORTANT NOTICES

- Do not direct the steam jet towards people, animals, or plants.
- Do not point the jet of steam in the direction of electrical or household appliances.
- Do not use the appliance with wet hands or bare feet.

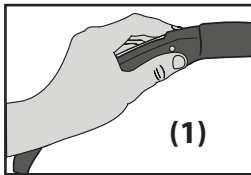

To unlock the steam cleaner, press the safety button on the right side (1).

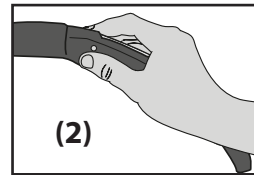

At the end of use it is recommended to lock the appliance pressing the button on the left side (2).

- Do not use the appliance when close to flammable or explosive substances.
- Do not insert any object in the various openings and do not use the appliance if any opening is obstructed.
- Do not store the appliance outdoors.
- Do not expose the appliance to atmospheric agents, humidity, or heat sources.
- Use a dry or slightly damp cloth to clean this appliance.
- Only use accessories and spare parts recommended by the manufacturer.
- The manufacturer, importer or distributor assume no responsibility for damage to property or injury to persons, in the event that this appliance is damaged as result of improper use or assembly.

IMPORTANT SAF

ATTENTION! This appliance is equipped with a 3-prong grounded power cord. Insert only into a 3-prong grounded electrical outlet. Do not try to remove the contacts of the grounded connection.

- Repairs must be carried out exclusively by personnel authorized by the manufacturer. Equipment repaired by unauthorized personnel poses a danger to the user and cancels the warranty.
- Do not pull on the electrical cord. Do not use the cord to move the appliance. Do not crush the cord by closing the door. Avoid any contact with sharp edges and corners. Keep the cord away from hot surfaces.
- The manufacturer reserves the right to make changes to the design and features of the appliance without notice.
- This appliance is intended for **domestic use only**.
- Connect the appliance only after making sure that the voltage of the electrical outlet corresponds to that indicated on the plate of the appliance.
- Do not immerse the Steam Cleaner in water or other liquids. Always turn off and unplug appliance when filling with water.
- Do not allow to be used as a toy. Close attention is necessary when used by or near children, pets or plants.
- Do not use with any opening blocked.
- Follow all labels and marking instructions on Steam Cleaner.
- Before filling with water or emptying, always unplug steamer and allow it to cool completely. Always turn the boiler cap slowly to open the boiler. This will allow any residual steam to escape gradually.
- Use caution while emptying the appliance. Contact with hot metal parts, hot water or steam may cause burns.
- Be sure Boiler Cap is (and remains) closed during use.
- Never use cleaning solutions, perfumes, oils or other chemical substances other than tap or distilled/demineralized water in the Steam Cleaner. Use of chemicals may damage appliance and will void your warranty.
- When in use, never turn the appliance on its side.
- This appliance is not to be used for space heating purposes.

CAUTIONS

Do not use Floor Steamer without a Pad attached to the system.

● Save your back

No need to press hard

The steamer does the work for you



ETY INSTRUCTION

CAUTIONS

- *Always drain condensed water from hose before use or if unit has been left idle for a period of time. To drain hose, direct Nozzle into a sink or other appropriate container and press the button on FRONT. Once hose is emptied, normal use may be resumed.*
- *Extreme care should be taken when opening the Boiler Cap as it may become hot during use and escaping steam can cause scalding.*

CORRECT DISPOSAL OF THIS PRODUCT

This marking indicates that this product should not be disposed with other household wastes throughout the US. To prevent possible harm to the environment or human health from uncontrolled waste disposal, we recommend recycling it responsibly to promote the sustainable reuse of material resources. To dispose of your used device, please contact your local city for proper disposal locations.

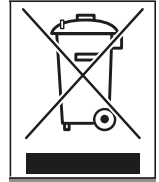

INDICATIONS OF USE

This manual cannot take into account every possible use. For further information or for any problems that are not covered in detail in this manual, please contact the Service Center or retailer. **Keep this manual in a safe place for future reference. Destroy all plastic bags and packaging material, they can be a risk for children!**

NOTE: Keep the packaging for possible future transport i.e., relocations, repairs, etc.

Attention: the photographs and/or drawings in this document are for illustrative purposes only. Actual appliance and the accessories may vary due to product enhancement.

One (1) Floor Steamer

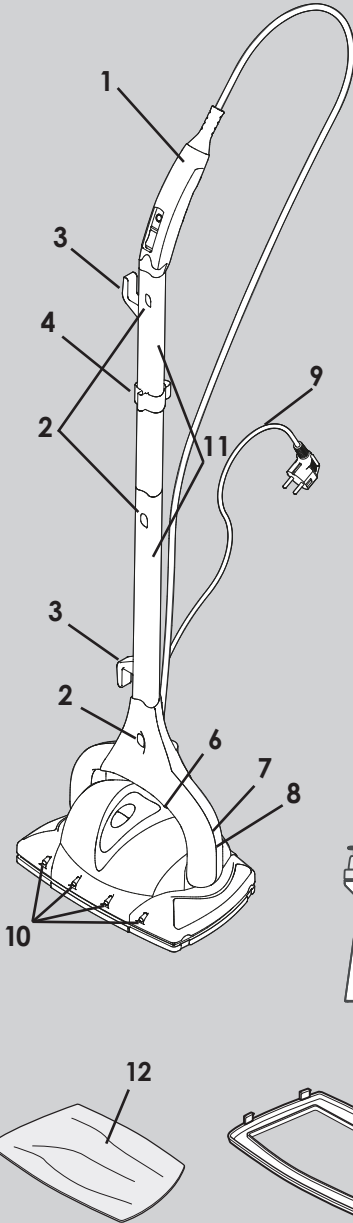

- 1 - Steam Handle with Switch
- 2 - Locking Buttons
- 3 - Cord Wrap
- 4 - Cleaning Hose Clamp
- 5 - Filling Bottle
- 6 - Boiler Cap
- 7 - Steam Ready Indicator Light (green)
- 8 - Power Indicator Light (orange)
- 9 - Power Cord
- 10 - Steam Jets
- 11 - Extension Tube
- 12 - Carpet Microfiber Pad
- 13 - Carpet Glider
- 14 - Microfiber Floor Pads (2)
- 15 - Parking Pad

Technical Data

Adapter Input: 120VAC~60Hz
Cord Length: 7 meters/23 feet
Power: 1200 watts
Boiler: Stainless Steel
Boiler Capacity: 0.6 liter/20 ounces



ACCESSORIES

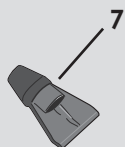
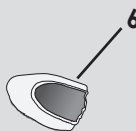
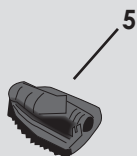
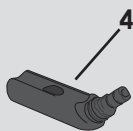
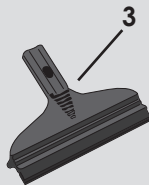
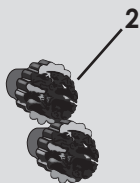
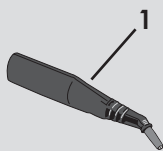

- 1 - Detail Nozzle
- 2 - Nylon Brushes (2)
- 3 - Window Cleaner
- 4 - Brush Adapter
- 5 - Small Brush

- 6 - Microfiber Pad for Small Brush
- 7 - Scraper
- 8 - Grout Brush
- 9 - Accessory Bag

1 FLOOR STEAMER MODE

Assembly of Parts & Preparation of Steamer

Make sure all parts are in the box (see pg 6-7).

IMPORTANT! FOLLOW THESE INSTRUCTIONS CAREFULLY.

WARNING! Always ensure steam switch is off and not steaming when attaching an accessory to the unit.

A. ATTACH HANDLE TO STEAMER

- Insert the lower Extension Tube into the Floor Steamer Base and press firmly in place (as shown in Fig. A).
- Insert the upper Extension Tube into the lower extension tube and press firmly in place (as shown in Fig. B).
- Insert the Handle Extension Tube into the upper extension tube and press firmly in place (as shown in Fig. C).
- Secure the steam hose (coming from the appliance to the handle) in the Cleaning Hose Clamp (4).

Attention! The lower Extension Tube has the cord support pointing down. The upper Extension Tube has the cord support pointing upwards.

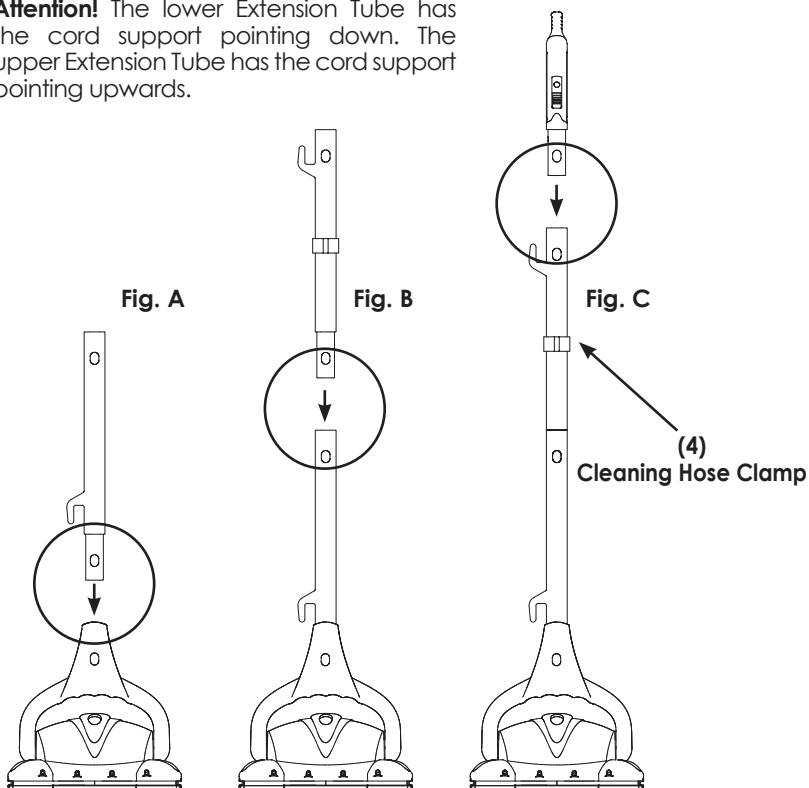

B. ATTACH CLEANING PADS TO STEAMER

WARNING! To prevent floor damage, ALWAYS attach either the Microfiber Floor Pad or the Carpet Glider Accessory with Carpet Pad when using your Floor Steamer. NEVER USE WITHOUT EITHER OF THESE ATTACHMENTS AFFIXED TO THE MACHINE.

ATTACHING FLOOR PAD

MICROFIBER FLOOR PAD – Place Microfiber Floor Pad face down on the floor, wide side forward. Hold Floor Steamer about 2" above Pad and gently place Floor Steamer on the Pad. Firmly press down to ensure Pad is adhered to the Floor Steamer.

The metal heat plate on bottom (A) provides extra heat to the floor pad to soften and remove dirt.

A - Heat Plate on bottom of Base boosts the cleaning performance.

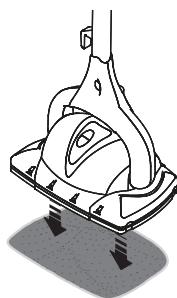
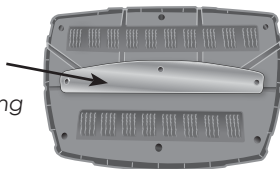

USE ON HARDWOOD FLOORS – For hardwood floors, use only on “sealed” hardwood surfaces.

Move Steamer forward and backward while cleaning, carefully observing the amount of steam used, as too much water could cause damage.

ATTACHING CARPET GLIDER WITH CARPET PAD

Place Carpet Glider face up on floor. Center and place Carpet Pad on top of Carpet Glider. Hold Floor Steamer over Carpet Glider and gently lower the Steamer onto the Glider. Make sure the 4 clips on Glider are around the outside of the Steamer Base and using hands, attach the 4 clips of the Carpet Glider to the Steamer Base.

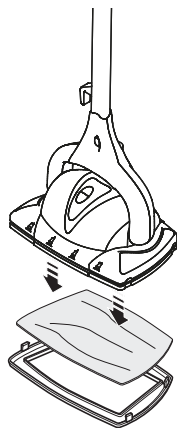

•IMPORTANT NOTE ABOUT LINOLEUM FLOORING•

Steam can cause wax to be stripped from floor, and consequently damage some varieties of linoleum flooring. ALWAYS test a small, inconspicuous portion of the floor BEFORE using steam to ensure that your linoleum floor does not have this issue. For some varieties of linoleum or vinyl floors the floor steamer is harder to push forward and back.

NOTE: See “Maintenance & Cleaning” for care and cleaning instructions for Microfiber Pads (see pg. 22).

C. FILLING BOILER WITH WATER

WARNINGS:

- Carefully read all instructions before removing Boiler Cap.
- Always unplug appliance before filling the Boiler.

IMPORTANT: Use ordinary tap water. Distilled water or demineralized water is suggested if tap water is too hard. DO NOT add detergents, perfumes, oils, or other chemical substances to the Boiler. The product warranty will be null and void if anything other than water is added to the Boiler.

Follow these instructions to fill the Boiler:

- Be sure appliance is unplugged from the electrical outlet and has **cooled for at least 5 minutes before filling with water.**
- **Make sure Handle Assembly is in the upright "off" position.** Remove Boiler Cap by turning it counterclockwise.
- Keeping the handle assembly pushed forward **(A)**, place the filling bottle upside down and insert the nozzle inside the boiler opening **(B)**. Press firmly on the bottle to deactivate the locking mechanism to release water. The filling bottle allows you to fill the boiler to correct level, avoiding overfilling.
- Keep the handle assembly pushed forward **(A)** while removing the bottle.
- Replace Boiler Cap by turning it clockwise. Do not tighten Boiler Cap too much, finger tightening is sufficient to lock the steam in the Boiler. If using cold water, heating time is about 3-5 minutes. If using warm water, heating time is reduced.

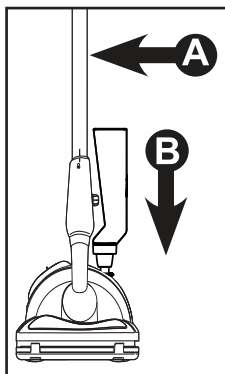
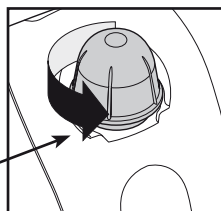

IMPORTANT

- Use the filling bottle when refilling your Boiler. The filling bottle has a built-in mechanism that prevents overfilling your Boiler. If you use a measuring cup to refill, add a maximum of 600ml (2 1/2 cups) of water when the Boiler is empty.
- If re-filling the Boiler while Steamer has been in use, be sure to allow Steamer to cool for at least 5 minutes and loosen Boiler Cap slowly to allow any excess steam to escape before completely removing Cap. (See page 13, "Refilling Boiler During Use" for detailed instructions.)

2

USING YOUR FLOOR STEAMER

A. USING THE PARKING PAD

You must use the Parking Pad if the Steamer is warm or hot.

WARNINGS

The Parking Pad is provided to prevent floor damage that can result from leaving a hot steamer resting on the same spot for too long. ALWAYS place Floor Steamer on the Parking Pad when not in use, or while it is cooling before storage.

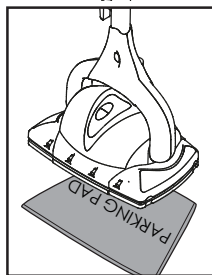

B. STARTING THE APPLIANCE

- Be sure Boiler is filled with water and Boiler Cap is securely in place.
- Insert the plug into a 3-prong grounded electrical outlet, orange Power Indicator Light will illuminate.
- **Keeping the handle in the upright “Off” position**, wait until the green Steam Ready Indicator Light illuminates.

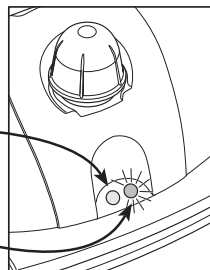

When the green Steam Ready Indicator Light illuminates, Steamer is ready for cleaning

PLEASE NOTE: *The green Steam Ready Indicator Light may turn on and off during use. This is normal and not a fault.*

C. USING STEAM

- Press the button on the right side of the handle to unlock the appliance.
- To emit steam from the underside of the Steamer, press the **FRONT** button on the handle.

You will find that your Floor Steamer can easily clean most hard surfaces and floors using the steam from the underside alone.

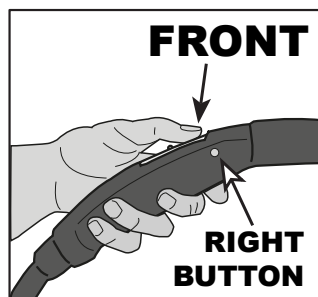

NOTE: *Some condensation may be emitted when the handle is first pulled down after filling. This is normal.*

D. USING STEAM (continued)

- To emit steam from the front jets, press the **REAR** button on the handle.
- **IMPORTANT:** at the end of the cleaning task, press the button on the left side to lock the appliance in safety mode.

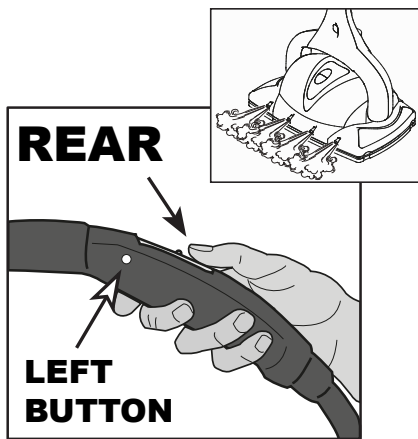
**·IMPORTANT·**

The Steam Jets are meant to be used in steam “bursts” and should never be used on a sustained basis. The Steam jets will loosen especially difficult debris and will assist in cleaning hard to reach areas such as floor edges.

NOTE: Your Steam Cleaner will not need refilling for about 20-25 minutes of usage.

The Steamer will stop producing steam when the Boiler is empty. When this happens unplug and store unit or refill with water per instructions below.

NOTE: If the Floor or Carpet Pad becomes too wet or too dirty, replace with a clean, dry Pad and continue cleaning.

E. REFILLING BOILER DURING USE

When the Steamer has run out of water, there will be no more steam coming out of the unit. At this stage it is time to refill the Boiler.

Follow the refilling instructions below.

·IMPORTANT·

Use the filling bottle when refilling your Boiler. The filling bottle has a built-in mechanism that prevents overfilling your Boiler. If you use a measuring cup to refill, add a maximum of 600ml (2 1/2 cups) of water when the Boiler is empty.

If cleaning is completed and water remains in the Boiler, the Steamer can be stored with the remaining water in the Boiler. There will be no harm done to the unit. At the next cleaning session simply fill the Boiler using the filling bottle.

WARNING: Let Steamer cool 5 minutes before opening Boiler Cap. Use care when opening Boiler Cap as it may still be hot and steam may escape, causing burns. If Boiler is still hot, water may spurt out during refilling which can also cause burns.

- **Unplug the appliance from the electrical outlet. This will stop the Steamer from continuing to heat up.**
- Slowly turn the Boiler Cap counterclockwise. This will allow remaining steam to slowly escape.
- **Be sure Steamer has cooled 5 minutes before refilling with water.**

The product warranty will be null and void if anything other than water is added to the Boiler.

- Keeping the handle assembly pushed forward **(A)**, place the filling bottle upside down and insert the nozzle inside the boiler opening **(B)**. Press firmly on the bottle to deactivate the locking mechanism to release water. The filling bottle allows you to fill the boiler to correct level, avoiding overfilling.
- Keep the handle assembly pushed forward **(A)** while removing the bottle.
- Replace Boiler Cap by turning it clockwise. Do not tighten Boiler Cap too much, finger tightening is sufficient to lock the steam in the Boiler. If you use cold water, the heating time is about 3-5 minutes. If you use hot water, the heating time is reduced.
- Insert plug into 3-prong electrical outlet. Wait for green Steam Ready Indicator Light to turn on. Steamer is ready to use once again.

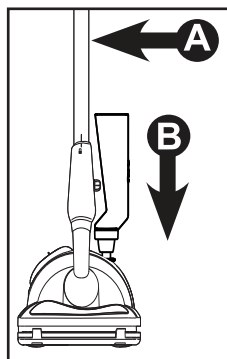

REMINDERS

- You can use ordinary tap water.
- If tap water is too hard, use distilled or demineralized water to avoid the risk of mineral deposits and sediment from forming.
- Do not add detergents, perfumes, oils or other chemical substances to the Boiler. This will damage the Steamer and void the warranty.
- The green Steam Ready Indicator Light may turn on and off during use. This is normal and not a fault.

IMPORTANT

Do not overfill the Boiler as excess water will be flushed out of the Boiler before dry steam will emit.

3 PORTABLE STEAM CLEANER MODE

MULTIPURPOSE PORTABLE STEAM CLEANER

The Hybrid Floor Steamer is a 2 in 1 model that converts into a multipurpose portable steam cleaner with just one click. The portable steam cleaner features include:

1. Lightweight and portable unit.
2. Ergonomic steam handle for ease of use.
3. Versatile and quick-change accessories.
4. Steam on/off control.

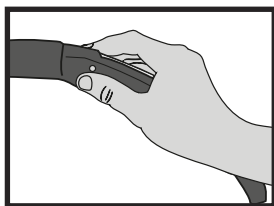

5. Security locking button.
6. Cleans many areas such as bathrooms, kitchens, pet areas and more.

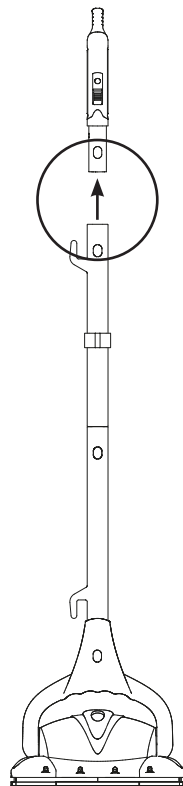

ACCESSORIES - ATTACHMENT & DESCRIPTIONS

A. ALWAYS USE THE PARKING PAD

B. ATTACH HANDLE TO STEAMER

To use: Hold down the locking button on the Steam handle while sliding it in an Extension Tube. Be sure the locking button lines up with the hole on the Extension Tube and button locks in place.

To attach Extension Tubes together: Press down the locking button while sliding Tubes together. Be sure button and hole line up and button locks in place.

To disconnect Extension Tubes: Press the locking button and pull the two sections apart.

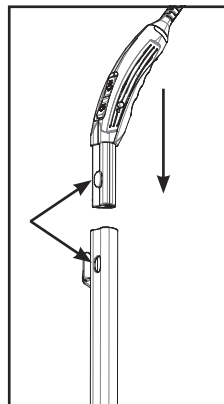

C. ATTACH EXTENSION TUBE TO BRUSH ADAPTER (4)

Once the desired Brush is attached to the Brush Adapter, press the locking button on the Extension Tube while sliding the Tube in the Brush Adapter. Ensure the locking button and the hole on the Brush Adapter line up.

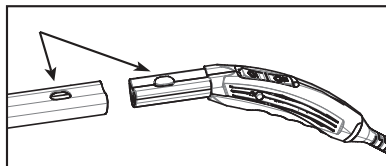

D. ATTACH EXTENSION TUBE OR STEAM HANDLE TO DETAIL NOZZLE (1)

The Detail Nozzle provides a powerful steam jet very useful for cleaning hard to reach areas. It is ideal for blasting dirt out of tight areas, cleaning door and window tracks, shutters, and sanitary fixtures.

To use: Slide and lock Detail Nozzle on the Steam Handle or Extension Tube.

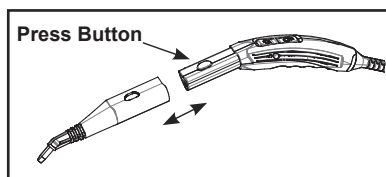

E. ATTACH GROUT BRUSH (8) TO DETAIL NOZZLE (1)

The Grout Brush is designed to clean the grout in between tiles. Use on grouted floors, backsplashes and in showers.

To use: Push the Grout Brush on the end of the Detail Nozzle.

(Detail Nozzle should be connected to the Steam Handle or Extension Tubes.)

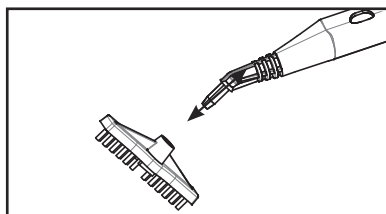

F. ATTACH EXTENSION TUBE OR STEAM HANDLE TO WINDOW CLEANER (3)

The Window Cleaner is very useful for cleaning large windows and glass.

To use: Connect Window Cleaner to Steam Handle or Extension Tube(s) for hard to reach surfaces. Apply steam liberally, rub with soft spongy edge, then remove excess water and dirt with Window Cleaner Blade. Wipe dirt from Window Cleaner blade.

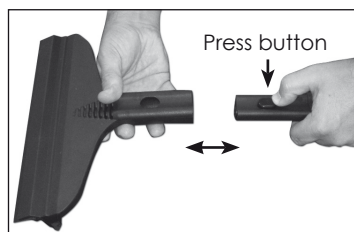

CAUTION: When cleaning windows, always avoid any sudden changes in temperature to prevent glass breakage or cracks.

G. ATTACH NYLON BRUSH (2) TO DETAIL NOZZLE (1)

The Nylon Brush is used to help scrub particularly tough dirt.

To use: Push the Nylon Brush on the end of the Detail Nozzle. (Detail Nozzle should be connected to the Steam Handle or Extension Tubes.)

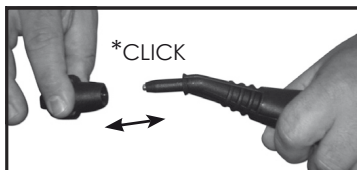

H. ATTACH SCRAPER (7) TO DETAIL NOZZLE (1)

The Scraper is best for removing small amounts of wallpaper and also anything that can be scraped from a flat surface, e.g., grease deposits in an oven. It is also useful when defrosting freezers.

To use: Push the Scraper on the end of the Detail Nozzle. (Detail Nozzle should be connected to the Steam Handle or Extension Tubes.)

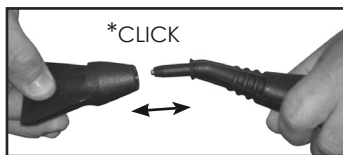

I. CONNECTING BRUSH ADAPTER (4) TO SMALL BRUSH (5)

The Small Brush attaches either to the extension tube(s) or the steam handle and is used to clean smaller areas that the Floor Steamer cannot easily reach, such as corners of floors, stairs and around furniture legs.

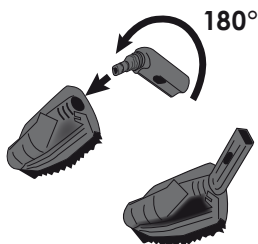

To use: Attach Small Brush to Brush Adapter. Attach Extension Tube or steam handle to Brush Adapter by pressing the locking button while sliding Tube or handle into Brush Adapter. Be sure button and hole line up (see images above) and button locks in place.

J. ATTACHING MICROFIBER PAD (6) TO SMALL BRUSH (5)

A Microfiber Pad should be placed over the bristles of the Small Brush to clean smooth surfaces such as kitchen cupboards, backsplashes, countertops, etc. Fit the Small Microfiber Pad over the Small Brush as shown below.

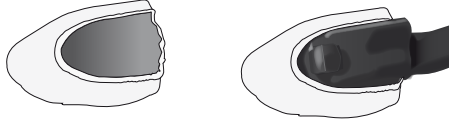

4 STEAM RELEASE

To release steam from the Steam Handle, press the button on **FRONT**. Steam will continue to be released while the button is pressed. To stop the steam, stop pressing the button.

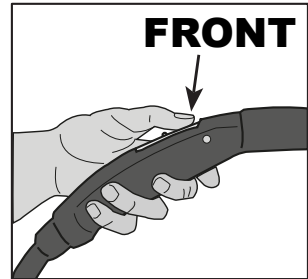

IMPORTANT: When the Steam Cleaner has run out of water, steam output will cease. Follow refill instructions (page 13) to use your Steam Cleaner again.

To move the steam cleaner around simply grab the base at the top of the arch as shown in the image.

WARNING

While using the appliance as a portable steam cleaner, keep the arch perpendicular (upright) to the body of the appliance to avoid the ejection of steam from the front jets.

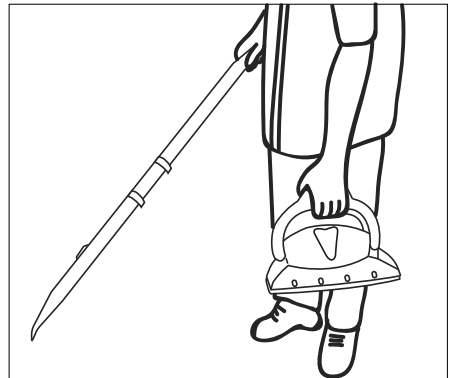

5 TURNING STEAM CLEANER OFF

- To turn Steam Cleaner off, unplug the power cord from the electrical outlet.
- Any remaining water can be left in the unit.

REMINDERS

- We suggest distilled water or demineralized water as the best way to care for and utilize your Steam Cleaner.
- If tap water is too hard, use distilled or demineralized water to avoid the risk of staining pale colored fabrics.
- Do not add detergents, perfumes, oils, or other chemical substances.

6 MAINTENANCE INSTRUCTIONS

We recommend you periodically clean the Steam Cleaner to prevent the accumulation of calcium, mineral deposits, and other sediment caused by the use of tap water. After every 10-15 refills, fill the Boiler three-quarters full of hot tap water, shake several times and empty out the water into a sink. Repeat several times to ensure that the Boiler is flushed of any calcium or mineral deposits. Wipe the Steam Cleaner with a damp cloth and dry.

***NEVER HOLD THE STEAM CLEANER UNDER THE TAP TO FILL.
Use the filling bottle provided to fill the Boiler.***

If distilled or demineralized water is regularly used in the Steam Cleaner, cleaning of the Boiler can be done less frequently. In some areas tap water is very hard, it is recommended that the Boiler is cleaned more frequently if hard water is used.

The cleaning of the Boiler and Steamer is the sole responsibility of the appliance owner. Calcium, mineral deposits, and other sediments left to build up in the Steam Cleaner causing it to fail and/or the steam pathways in the Steam Cleaner to block, is not covered by the product warranty. Users must follow the cleaning instructions above.

If the Steam Cleaner and Boiler is not cleaned according to the instructions above and the product fails and/or the steam pathways are blocked, the appliance owner should send the product for servicing by contacting the Customer Support Line.

The Steam Cleaner is intended for domestic household use only. It is not intended for commercial use. Any use other than for domestic household purposes will void the product warranty.

7 REPLACEMENT OF BRUSHES, MICROFIBER PADS AND ACCESSORIES

The Nylon Brushes and the fitted Microfiber Pad for the Small Brush provided with the Steam Cleaner are to get you started using your Steam Cleaner. As these brushes and microfiber pads become dirty or wear out, replacement brushes and microfiber pads can be purchased from the retailer from which you purchased your Steam Cleaner or from our website www.euroflexproducts.com.

It is recommended to have replacements of the brushes and microfiber pads close at hand when doing cleaning as the brushes wear out or the microfiber pads become dirty.

Any of the other accessory tools are replaceable by contacting the Customer Support Line at hello@euroflexproducts.com.

8 STEAM CLEANER TIPS & REMINDERS

Steam cleaning allows the user to clean chemical-free by using the power of steam, in place of harsh chemical-based cleaners. The heat from the steam softens and loosens dirt on surfaces, while the steam pressure lifts the dirt away. All that is left to do is to wipe the surface to remove the dirt and moisture using a cloth (preferably with a microfiber cloth).

TIP: To get the best cleaning results use a microfiber cloth to wipe the dirt and moisture from the surface being cleaned. Microfiber is designed to pick up and hold dirt, a great aid in lifting and removing the dirt that the steam cleaner has softened and loosened. Also, Microfiber requires moisture to glide over surfaces, the steam cleaner provides moisture that the Microfiber needs to glide. Microfiber and Steam, a great cleaning combination!

MAKING CONTACT WITH SURFACES

The steam is at its hottest just as it leaves the nozzle/accessory. This is the area of the steam output that should be used to clean to achieve maximum performance. All accessories should make direct contact with the surfaces being cleaned to transfer the heat from the Steam Cleaner to the surface in order to soften and loosen dirt. If the accessory being used does not make contact with the surface, the desired results may not be achieved. If assistance is required contact our Customer Support Line.

TIP: Steam will clean hard, sealed, non-porous surfaces in place of harsh chemical-based cleaners and detergents. For soft furnishings such as carpets, rugs, lounges, children's toys, etc, steam will refresh, sanitize, and deodorize the fibers. Steam is not used to clean carpets, other than to spot clean. To clean carpets properly, carpet cleaning equipment should be used.

WATER

Use ordinary tap water for all cleaning. In hard water areas, we recommend distilled or demineralized water to reduce the formation of calcium and other mineral deposits in the Steam Cleaner. Use distilled or demineralized water when steaming light colored fabrics to eliminate the possibility of hard water stains.

IMPORTANT: Do not add cleaning solutions, perfumes, oils or any other chemicals to the water used in the Boiler.

TEMPERATURE

The temperature in the stainless-steel Boiler reaches about 130°C (275°F). The steam temperature just outside the tip of the nozzle/ accessory is between 105°C and 115°C. The temperature of the steam falls to 38°C at a distance of 25cm from nozzle. This Steam Cleaner produces a drier steam which cools very rapidly to avoid burns and injuries. Steam must make direct contact with surfaces for it to clean effectively.

TIP: Hot steam can be used to kill dust mites in soft furnishings and mattresses. The Steam Cleaner is ideal for asthma sufferers, persons with skin sensitivities and anyone with chemical sensitivities.

9

MICROFIBER PAD CARE & CLEANING

Your Microfiber Pads are designed for hundreds of uses. Clean Pads regularly, either by hand washing (using mild soap and warm water) or in your washing machine on a delicate cycle, cool water. Never use fabric softener or bleach. We recommend letting Pads air dry to maintain maximum long term effectiveness.

Replacement pads are available at most retail outlets or on our website at www.euroflexproducts.com.

Microfiber washing instructions – ULTRA MICROFIBER

| MICROFIBER FLOOR PAD | CARPET PAD |
|--|--|
| <p>90% Polyester / 10% Polyamide</p> <p>Hand wash only Tumble dry low or air dry No bleach / No fabric softener</p> | <p>90% Polyester / 10% Polyamide</p> <p>Hand wash only Tumble dry low or air dry No bleach / No fabric softener</p> |

10 TROUBLESHOOTING

| ISSUES | POSSIBLE CAUSES | SOLUTIONS |
|---|--|---|
| Steam is not coming out of the Steam Jets | Improper Handle Assembly | Call Customer Service to receive instructions to correct the problem |
| The Hard Surface Floor Pad is not adhering to Steamer | Not enough pressure was applied when attaching Pad | Position Steamer about 2" above Pad and FIRMLY press it down onto the Pad |
| | Floor Pad requires replacing due to age of the Floor Pad | Replacement Floor Pads can be purchased at most electrical appliance retail outlets |
| The Cleaning Pads are getting soaked (too wet). Why? | Boiler is overfilled | Let Steamer run until excess water ceases. Remove some water from Boiler once the Boiler has cooled down completely |
| | Green "Steam Ready Indicator Light" is not illuminated | Wait for green "Steam Ready Indicator Light" to illuminate |
| The steam seems to be making my floor too wet | Front Steam Jets are being used too frequently | Only use Front Steam Jets in short bursts for cleaning tougher dirt or to clean hard to reach areas |
| | The Cleaning Pad is too wet (saturated with moisture) | Replace the wet Pad with a dry, clean Pad and resume cleaning |

IMPORTANT QUESTION:

Q: Do I always need to use a Microfiber Pad when cleaning with my Floor Steamer?

A. YES! It is critically important to ALWAYS use your Microfiber Pads. The Floor Steamer should NEVER be used without either a Hard Surface Floor Pad or Carpet Glider with Carpet Pad.

Q: Why is my Vapour M4S Steam Cleaner sometimes harder to glide across my floors?

A. If the microfiber floor pad does not have enough moisture, it can be more difficult to push across your floor. Press the Front steam button on your handle to emit steam from the underside of the steamer. This will replenish the moisture in the pad allowing your steam cleaner to glide easier across the floor while keeping your pad hot to help loosen and remove dirt & debris while cleaning. The microfiber pad needs both moisture and heat to achieve the best cleaning results.





Euroflex USA
5940 S Rainbow Blvd., #400
PMB 91217
Las Vegas, Nevada 89118-2507

Email: hello@euroflexproducts.com
Website: euroflexproducts.com