

REFRIGERATOR MANUFACTURER  
**Turbo air**

*Turbo Air Speed up the Pace of Innovation*

**CAUTION!**  
PLEASE KEEP POWER  
SWITCH ON BEFORE  
OPERATING THIS EQUIPMENT

# Ice Cream Dipping Cabinets Installation and Operation Manual

Please read this manual completely before attempting to install or operate this equipment!

TIDC-26G(W)  
TIDC-47G(W)  
TIDC-70G(W)  
TIDC-91G(W)



[www.turboairinc.com](http://www.turboairinc.com)

## CONTENTS

<b>Names of Components</b>	3
<b>Specification</b>	4
<b>About the TIDC Models</b>	5
<b>Installation</b>	6
<b>Adjusting the Temperature</b>	7
<b>Defrosting</b>	8
<b>Safety Precautions</b>	9
<b>Tips</b>	10
<b>Managing and Storing</b>	10
<b>Before Requesting for Service</b>	11
<b>Precautions</b>	12-13
<b>Warning / Caution</b>	14-15
<b>Warranty</b>	16-18

## NAMES OF COMPONENTS

**TIDC - 26 G / W**

① ② ③ ④

① : TIDC - Turbo Ice Dipping Cabinet

② : Model Dimension Width (Inch)

③ : Color - Green

④ : Color - White

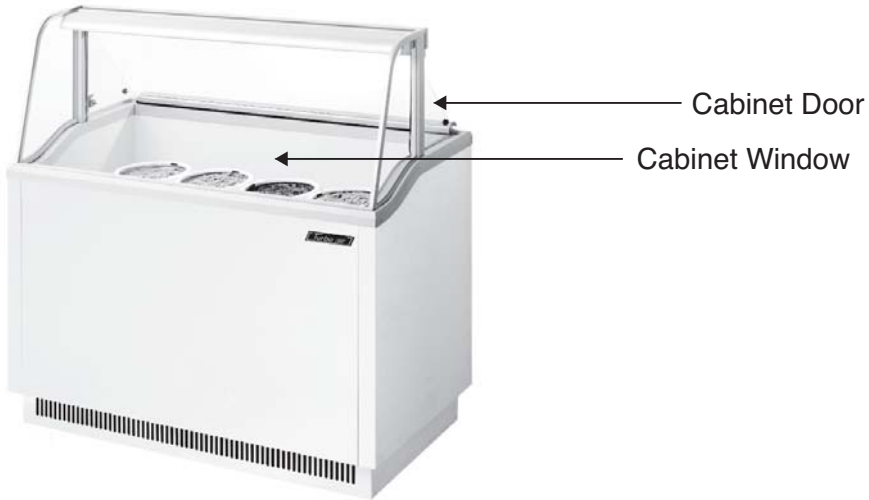

Cooling Cover



Shelves



Shelves Cover

# SPECIFICATION

\*. TIDC-47 View

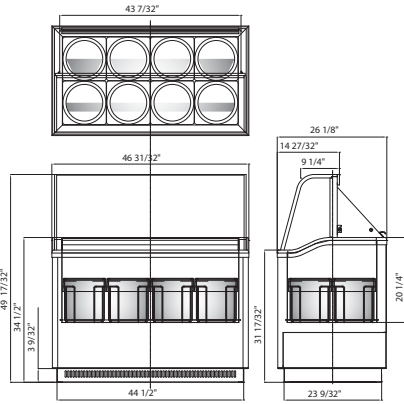

\*. TIDC-70 View

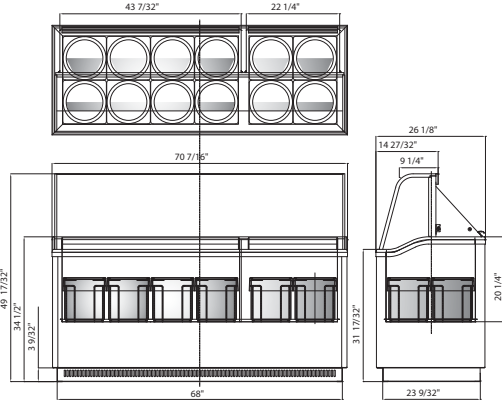

\*. TIDC-26 View

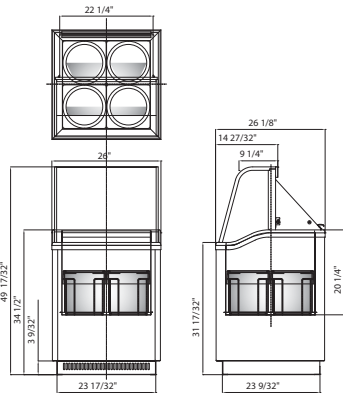

\*. TIDC-91 View

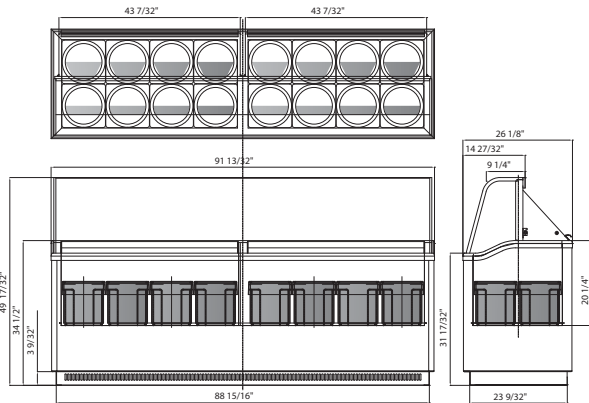

Model	Capacity (cu.ft./3gal.cans)	Dimension (WxDxH) in.	Racks	Cooling Type	Cooling Control	Defrost Type	Temperature	Refrigerant	Power Consumption	Weight (lbs.)
TIDC-26G(W)	5.19 / 4	26 x 26 1/8 x 49 1/2	4	Direct Cooling	Digital	Defrost during Cooling	0 ± 5 °F	R-134A	280W	227
TIDC-47G(W)	10.31 / 8	47 x 26 1/8 x 49 1/2	8	Direct Cooling	Digital	Defrost during Cooling	0 ± 5 °F	R-404A	400W	375
TIDC-70G(W)	16.07 / 12	70 3/8 x 26 1/8 x 49 1/2	12	Direct Cooling	Digital	Defrost during Cooling	0 ± 5 °F	R-134A	550W	518
TIDC-91G(W)	21.19 / 16	91 3/8 x 26 1/8 x 49 1/2	16	Direct Cooling	Digital	Defrost during Cooling	0 ± 5 °F	R-134A/ R404A	670W	672

## ABOUT THE TIDC MODELS

- It is designed to provide maximum convenience to users and store ice cream products.
- You can adjust the temperature of the freezer system from 9°F to -5°F.
- The cooling system is equipped with customized cooling coil characterized by low noise to improve temperature deviation and energy efficiency.
- It is equipped with a PVC shelf with a handle to enable placing ice cream containers easily and arranging each of them stably. To preserve the ice cream's flavor, the container cover is simply designed.
- It can accommodate ice cream containers with capacity of up to 3 gal. (12 ℓ ) and diameter of 9.5 inch (242mm).
- The freezer system uses environment-friendly refrigerant such as R-134A or R-404A; the door is designed as a top open type to prevent the leak of cool air. The cooling system uses the direct cooling system, and the heater is attached on the cooling surface to remove frost easily .
- Each lighting of the safely protected LED LAMP , which delivers a glossier image of ice cream, has an ON/OFF switch.
- To operate, just plug the cord into the 115V outlet.
- This product is designed to be operated under room temperature of 75°F and humidity of 55%. Avoid direct sunlight and severe temperature change.

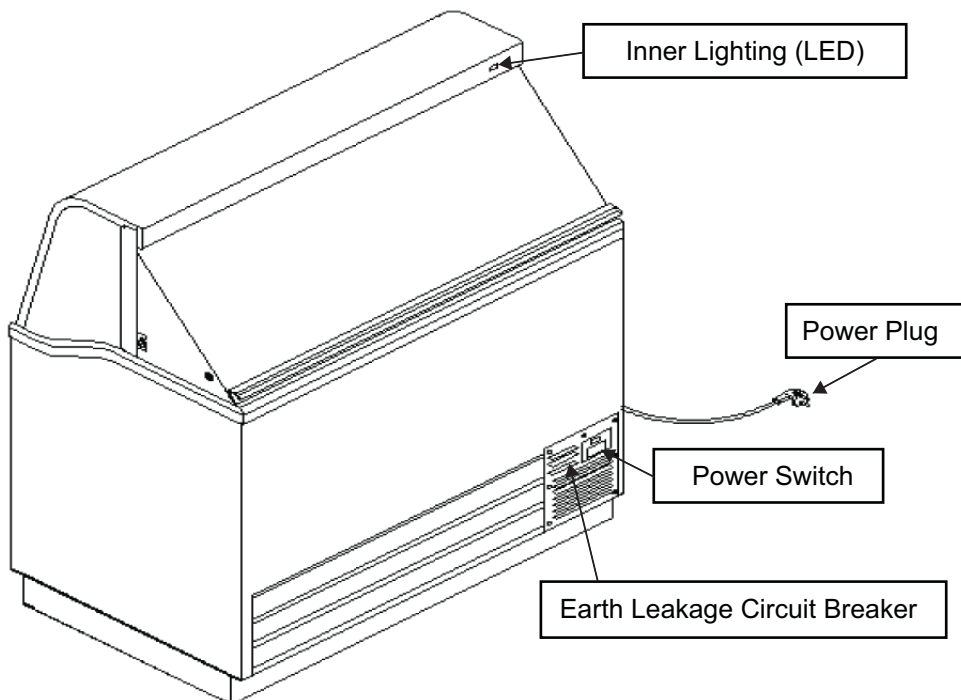

**\*The earth leakage circuit breaker is behind the air outlet.**

# INSTALLATION

## ***Installing***

Install on a flat ground.  
Otherwise, it may result in movement of the product,  
interference in drainage, or noise and vibration.



Do not install near places with rain, snow, direct  
sunlight, heating equipment, or humid space  
It may decrease the cooling capacity and shorten the  
life cycle of the product.



## ***Never ground in the following places:***

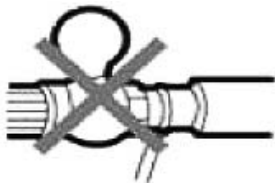

Gas Pipe



Telephone Wire



Lighting Rod

## ADJUSTING THE TEMPERATURE

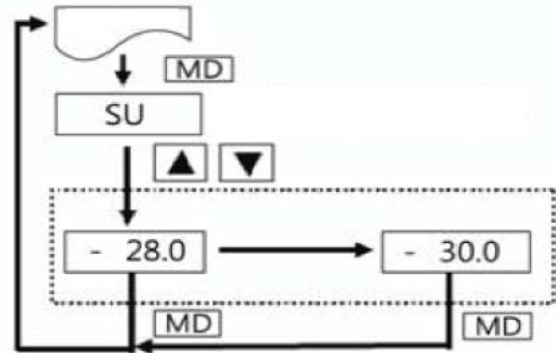

- The set value will flash every 0.5 seconds. Use the [▲] or [▼] key to set (change) the value.
- After changing the set value, press the [MD] key to save the value and return to the operation mode.
- If you do not press any key for 60 seconds during setting, the operation mode will be restored automatically.

## DEFROSTING



Before defrosting, transfer the items in the freezer to another freezer to prevent them from melting.

### How to defrost

Too thick frost on the refrigerator will decrease the cooling capacity and increase power consumption. In case of frost thicker than 4 inch, please defrost with the following instruction:

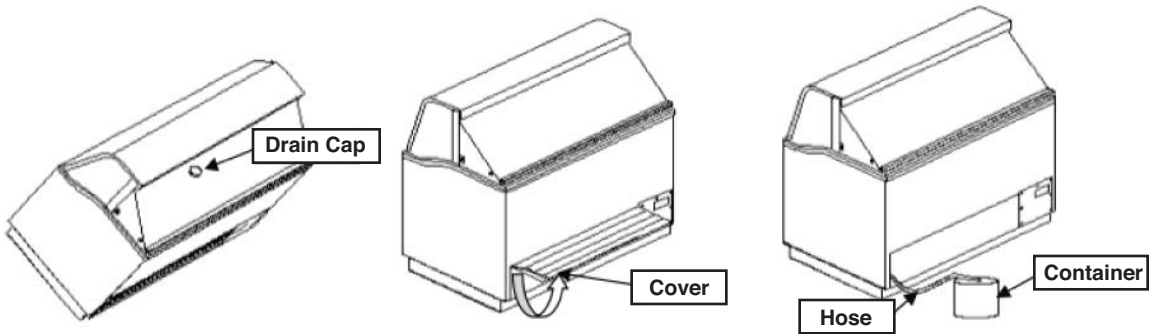

1. Pull out the drain cap.

2. Open the cover of the machine room.

3. Prepare the container for collecting the water with the drain hose.

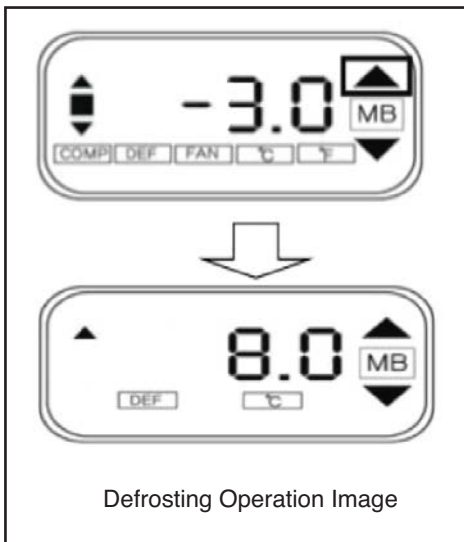

4. Press the [▲] key for 3 seconds to activate the defrosting operation mode. The inner heater [DEF] will operate to melt the frost on the wall.

5. After a certain period (30~40 minutes), the freezer [COMP] storage mode will be restored automatically. Please remove the existing water and pieces of ice completely.

6. If the frost is not removed sufficiently, press the [▲] key for 3 seconds again.



#### Note

Never use metal such as ice pick or knife to defrost. It may damage the surface of freezer, decrease the cooling capacity, or cause failure.

After unplugging, wait for more than 5 minutes before plugging again. Suspension of operation for a short time is not an indication of failure; it is an automatic adjustment process by the [Temperature Controller]

# SAFETY PRECAUTIONS

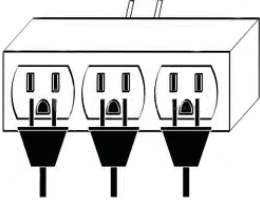
## Cautions in use

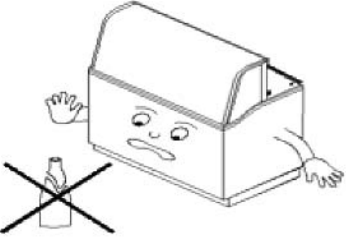
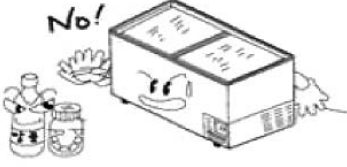
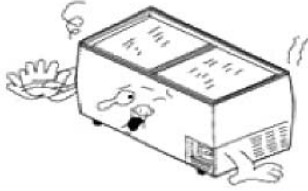
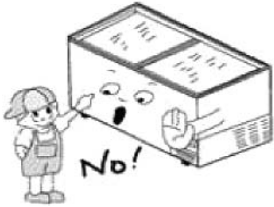
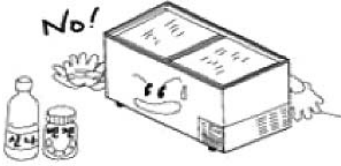
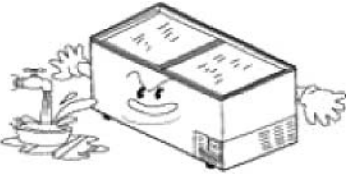
<p><b>Outlet</b> Do not connect multiple electric devices to one outlet. It may cause fire.</p> 	<p><b>Plug</b> When unplugging, be sure to hold the plug and not the cord. (Check the plug and cord regularly and replace them immediately if damaged.)</p> 	<p><b>Bottle and can</b> Do not store bottles or cans. They may break when frozen.</p> 
<p><b>Objects to be avoided</b> Never store benzene, alcohol, medicines, and inflammables. They may explode.</p> 	<p><b>Storage capacity</b> Food must not exceed the "storage limit." The proper temperature should be maintained.</p> 	<p><b>Children's Safety</b> When the showcase is operated, never touch the machine room on the back. The air blower is spinning fast. Keep out of reach of children.</p> 
<p><b>Cleaning</b> When cleaning, do not use benzene or thinner. It may cause discoloration.</p> 	<p><b>Do not splash water.</b> When cleaning the showcase, do not splash water directly. It may cause electric leakage or electric shock.</p> 	

## TIPS

### ***In case of power failure***

- When power failure is announced in advance:
  - Do not put in newly cooked food (it will increase the internal temperature).
  - Do not remove frost in the freezer.
- When power is cut off suddenly:
  - Minimize the opening of the door as much as possible.
  - Even in summer, cooling will be maintained for 1~2 hours.

## MANAGING AND STORING

### ***How to manage***

For longer product life, please check and manage the product regularly.

1. First, pull the plug from the outlet.
2. Remove all food in the freezer.
3. Wipe the product using a soft cloth moistened with a dishwashing detergent.  
Wash with clean water and wipe with a dry cloth.

Note

---

- When managing the showcase, never spray water directly.

### ***When the showcase will not be used for a long time***

1. Unplug.
2. Wipe off the water generated from frost.
3. Open the door to dry the freezer completely and store the product in a well-ventilated space.

## BEFORE REQUESTING FOR SERVICE

- If there is a problem in the product, check the following first.
- When checking the product, be sure to unplug it first.

Symptom	Cause
The cooling function has stopped completely.	<ul style="list-style-type: none"> <li>• Is it due to the power failure?</li> <li>• Is the product unplugged?</li> <li>• Is the switch of the earth leakage circuit breaker turned "OFF"?</li> <li>• Is the ON, OFF switch of the temperature controller turned "ON"? (- mark)</li> </ul>
The freezing function is insufficient.	<ul style="list-style-type: none"> <li>• Is the product in a place with direct sunlight?</li> <li>• Is the product near a heating device?</li> <li>• Is the ventilation disrupted due to too much dust in the condenser?</li> <li>• Is there thick frost on the freezer?</li> <li>• Is the door closed completely?</li> </ul>
The product is making so much noise.	<ul style="list-style-type: none"> <li>• Is the floor or installation site unstable?</li> <li>• Does the air blower on the back come into contact with a plastic bag or other plastic products?</li> </ul>
Beads of water have formed on the outside or door of the showcase.	<ul style="list-style-type: none"> <li>• It is a temporary condition generated under high temperature and humidity, e.g., during the rainy season. It is not an indication of failure. Please wipe off with a dry cloth.</li> </ul>

\* Note: For the ON, OFF switch, the pressed state (- mark) means that the product is in operation.

## PRECAUTIONS

Please read the Safety Precautions and take the necessary actions before use.



### Installation Precautions

To prevent fire, electric shock, or electric leakage.

- When installing, avoid having the power plug and power cable pinned down by the showcase or other objects.



- Do not use the extension wire.
- Do not install the product where water may flow or accumulate on the ground.





### Usage Precautions

To prevent injury, fire, electric shock, or electric leakage

- Read the user's manual.
- After reading the user's manual and 「Safety Precautions」, store them in a visible place.

# PRECAUTIONS

*To use the product properly, please read these "Safety Precautions" before use.*

 <p>Warning</p> <p>May cause serious damage such as death or fatal injuries</p>	 <p>Caution</p> <p>May cause serious / slight injuries or damage to property</p>
--	---

## Indication examples



This means that you must not disassemble the product.



This mark means 「Prohibition」 (do not).









This means that you must disconnect the power plug from the outlet.



















This mark means 「Precaution」 (should be observed).







## **Warning**

	<p>The power source must be 115V.</p> <ul style="list-style-type: none"> <li>• Otherwise, it may result in fire, electric shock, or failure.</li> </ul>		<p>Do not use a multi-outlet.</p> <ul style="list-style-type: none"> <li>• Complex wiring may cause abnormal heating and fire.</li> <li>• Connect only one product to an outlet more than 15A.</li> </ul>
	<p>Take care not to have the power plug and power cable pinned down by the showcase or other objects.</p> <ul style="list-style-type: none"> <li>• It may cause fire</li> </ul>		<p>Do not use damaged cord or power plug or loose outlet.</p> <ul style="list-style-type: none"> <li>• It may cause short circuit, electric leakage, or overheating, which in turn may cause electric shock or fire</li> </ul>
	<p>Prevent the sheath from being peeled off by a heavy object; do not pull or bend forcibly.</p> <ul style="list-style-type: none"> <li>• Damaged sheath may cause fire or electric shock.</li> </ul>		<p>When unplugging, do not pull the cord.</p> <ul style="list-style-type: none"> <li>• It may cause the disconnection of cord or short circuit, which in turn may cause electric shock or fire.</li> <li>• Always hold the power plug.</li> </ul>









## **Warning**

	<p>Do not hold the power plug with wet hands.</p> <ul style="list-style-type: none"> <li>• It may cause electric shock</li> </ul>		<p>Ground thoroughly.</p> <ul style="list-style-type: none"> <li>• Inadequate grounding may cause electric leakage due to failure and electric shock.</li> <li>• Damaged electric insulation may cause electric shock or fire.</li> </ul>
	<p>Do not ground on water pipe, gas pipe, telephone line, and lightning rod.</p> <ul style="list-style-type: none"> <li>• It may cause fire or electric shock</li> <li>• For grounding, contact the retailer where you made your purchase.</li> </ul>		<p>Do not install the product in a humid place.</p> <ul style="list-style-type: none"> <li>• Damaged electric insulation may cause electric shock or fire.</li> </ul>
	<p>Insert the power plug with the cord face down.</p> <ul style="list-style-type: none"> <li>• If you insert with the cord facing upward, the cord may overheat or cause short circuit, which in turn may cause electric shock or fire.</li> </ul>		<p>When inserting the power plug, hold it firmly.</p> <ul style="list-style-type: none"> <li>• Damaged electric insulation may cause electric shock or fire.</li> </ul>
	<p>The power cord must not come into contact with an electric heater.</p> <ul style="list-style-type: none"> <li>• Damaged cord may cause fire or electric shock.</li> <li>• If the cord is damaged, stop using the product and contact our service center for the replacement of parts.</li> </ul>		<p>Do not place a container with water on the showcase.</p> <ul style="list-style-type: none"> <li>• If the water spills, and the insulation of electric parts is damaged, electric leakage, electric shock, or fire may occur.</li> </ul>
	<p>Do not splash water on or inside the main body.</p> <ul style="list-style-type: none"> <li>• Damaged electric insulation may cause electric shock or fire.</li> </ul>		<p>Do not move the shelf when there is an item on it.</p> <ul style="list-style-type: none"> <li>• If the shelf falls, it may injure people.</li> </ul>
	<p>Do not hold the showcase's door to pull it down.</p> <ul style="list-style-type: none"> <li>• It may cause injury if the hand is caught</li> </ul>		<p>Do not move the shelf when there is an item on it.</p> <ul style="list-style-type: none"> <li>• If the shelf falls, it may injure people.</li> </ul>
	<p>Never try to disassemble, repair, or remodel the product.</p> <ul style="list-style-type: none"> <li>• It may cause fire or malfunction, which in turn may cause fatal injury.</li> </ul>		<p>If you suspect that an inflammable gas leaked, ventilate to prevent contact between the gas and showcase.</p> <ul style="list-style-type: none"> <li>• In case of electric contact, explosion, fire, or burn may occur.</li> </ul>
	<p>Do not use flammable spray near the product.</p> <ul style="list-style-type: none"> <li>• Ignition following electric contact may cause fire.</li> </ul>		<p>Do not insert inflammables.</p> <ul style="list-style-type: none"> <li>• Thinner, benzene, LP gas, and glue may cause ignition or explosion.</li> </ul>

## **Warning**

	<p>Do not store medicine or laboratory specimens.</p> <ul style="list-style-type: none"> <li>• Do not store an item that requires strict temperature control in the showcase.</li> </ul>		<p>When inserting your hand into the machine room at the lower back, be sure to unplug the product first.</p> <ul style="list-style-type: none"> <li>• Otherwise, it may result in electric shock or burn.</li> <li>• The spinning fan may cause injury.</li> </ul>
	<p>To replace the fuse, use a fuse with the same capacity.</p> <ul style="list-style-type: none"> <li>• The use of improper fuse may cause fire.</li> </ul>		<p>To replace the inner lighting or fluorescent light, disconnect the power first.</p> <ul style="list-style-type: none"> <li>• Otherwise, it may result in electric shock.</li> </ul>
	<p>If the power cord is damaged, please contact our service center.</p> <ul style="list-style-type: none"> <li>• Damaged power cord may cause fire, electric shock, or electric leakage.</li> </ul>		<p>To dispose of the showcase, remove the glass door.</p> <ul style="list-style-type: none"> <li>• If a child is locked in, he/she may be suffocated.</li> <li>• If the glass breaks, it may cause serious injury to other persons.</li> </ul>

## **Caution**

	<p>Unplug the product if it will not be used for a long time.</p> <ul style="list-style-type: none"> <li>• Otherwise, it may result in the risk of fire.</li> </ul>		<p>Do not insert a bottle into the freezer.</p> <ul style="list-style-type: none"> <li>• If the bottle freezes and breaks, it may cause serious injuries.</li> </ul>
	<p>Do not place your hand beneath the showcase.</p> <ul style="list-style-type: none"> <li>• If you place your hand beneath the showcase when cleaning, the sharp steel plate may cause serious injuries.</li> </ul>		<p>Do not touch the food and container in the freezer and cooler with wet hands.</p> <ul style="list-style-type: none"> <li>• Doing so can result in frostbite.</li> </ul>
	<p>To replace the inner lighting or fluorescent light, wear gloves since it may break or cause burns.</p> <ul style="list-style-type: none"> <li>• Place the inner lighting or fluorescent light into the socket firmly.</li> </ul>		<p>Moving the product may scratch the floor.</p> <ul style="list-style-type: none"> <li>• If you move it forcibly, it will damage the floor.</li> <li>• For vulnerable floor, support with a protective board.</li> </ul>
	<p>Do not eat food with bad smell or discoloration.</p> <ul style="list-style-type: none"> <li>• Even if stored in the freezer or cooler, food may spoil after a long time.</li> </ul>		<p>If the glass is heated, it may break.</p> <ul style="list-style-type: none"> <li>• The pieces of broken glass may cause serious injury.</li> </ul>
	<p>Do not touch the condenser or piping at the lower back.</p> <ul style="list-style-type: none"> <li>• The condenser or piping is very hot when the product is operating or it just stopped (may cause burns).</li> </ul>		

## ONE YEAR WARRANTY

Turbo air warrants to the original purchaser of every new Turbo air refrigerated unit, the cabinet and all parts thereof, to be free from defects in material or workmanship, under normal use and service, for a period of one(1) year from the date of original installation or 15 months after shipment date from Turbo air , whichever occurs first.

Any parts covered by this warranty that are examined and determined by Turbo air to have been defective within one (1) year of original installation or fifteen (15) months after shipment date from manufacturer, whichever occurs first, shall be repaired or replaced as stated below. Turbo air shall be deemed to have fully complied with its obligation under the foregoing warranties by electing either one of the following procedures, at the sole discretion of Turbo air.

1. Furnishing a replacement part, freight collect, in even exchange for the returned part, freight collect.
2. Receiving the defective part, freight collect; repairing it; and returning it, freight collect.

## ADDITIONAL FOUR YEAR COMPRESSOR WARRANTY

In addition to the (1) one year warranty stated above, Turbo air warrants its hermetically and semi-hermetically sealed compressor to be free from defects in both material and workmanship under normal use and service for a period of four (4) additional years from the date of original installation but not to exceed five (5) years and three (3) months after shipment from manufacturer.

Compressors determined by Turbo air have been defective within this extended time period will, at Turbo air's option, be either repaired or replaced with a compressor or compressor parts of similar design and capacity.

The for (4) year extended compressor warranty applies only to hermetically and semi-hermetically sealed parts of the compressor and does not apply to any other parts or components, including, but not limited to, cabinet, paint finish, temperature control, refrigerant, metering device, driers, motor starting equipment, fan assembly any other electrical component, etcetera.

## 134A(404A) COMPRESSOR WARRANTY

The four year compressor warranty detailed above will be voided if the following procedure is not carefully adhered to:

1. This system contains R134A refrigerant and polyol ester lubricant. The Polyol ester lubricant has rapid moisture absorbing qualities. If long exposure to the ambient conditions occur, the lubricant must be removed and replaced with new. Listed below are the approved lubricants for the Tecumseh compressors.

- 1 ICI-Emkarate RL 184
- 2 Emery-2927-A
- 3 Mobile Artic 22A

Failure to comply with recommended lubricant specification will void the compressor warranty.

2. Dryer replacement is very important and must be changed when a system is opened for servicing. dryer must be used with XH-9 desiccant.
3. Micron level vacuums must be achieved to insure low moisture levels in the system. 500 microns or lower must be obtained.

## What is NOT covered by this warranty

Turbo air's sole obligation under this warranty is limited to either repair or replacement of parts, subject to the additional limitations below. This warranty neither assumes nor authorizes any person to assume obligations other than expressly covered by this warranty.

1. **WARRANTY IS NOT TRANSFERABLE.** This warranty is not assignable and applies only in favor of the original purchaser/user to whom delivered. ANY SUCH ASSIGNMENT OR TRANSFER SHALL VOID THE WARRANTIES HEREIN MADE AND SHALL VOID ALL WARRANTIES, EXPRESS OR IMPLIED, INCLUDING ANY WARRANTY OF MERCHANTABILITY OR FITNESS FOR A PARTICULAR PURPOSE.
2. **NO CONSEQUENTIAL DAMAGES.** TURBO AIR IS NOT RESPONSIBLE FOR ECONOMIC LOSS; PROFIT LOSS OR SPECIAL, INDIRECT, OR CONSEQUENTIAL DAMAGES, INCLUDING WITHOUT LIMITATION, LOSSES OR DAMAGES ARISING FROM FOOD OR PRODUCT SPOILAGE CLAIMS WHETHER OR NOT ON ACCOUNT OF REFRIGERATION FAILURE.
3. **ALTERATION, NEGLIGENCE, ABUSE, MISUSE, ACCIDENT, DAMAGE DURING TRANSIT OR INSTALLATION, FIRE, FLOOD, ACTS OF GOD.** TURBO AIR is not responsible for the repair or replacement of any parts that Turbo Air determines have been subjected after the date of manufacture to alteration, neglect, abuse, misuse, accident, damage during transit or installation, fire, flood, or an Act of God.
4. **NO IMPLIED WARRANTY OF MERCHANTABILITY OR FITNESS FOR A PARTICULAR PURPOSE.** THERE ARE NO OTHER WARRANTIES, EXPRESS, IMPLIED OR STATUTORY, EXCEPT THE ONE(1) YEAR WARRANTY AND THE ADDITIONAL FOUR (4) YEAR COMPRESSOR WARRANTY AS DESCRIBED ABOVE. THESE WARRANTIES ARE EXCLUSIVE AND IN LIEU OF ALL OTHER WARRANTIES, INCLUDING IMPLIED WARRANTY AND MERCHANTABILITY OR FITNESS FOR A PARTICULAR PURPOSE. THERE ARE NO WARRANTIES WHICH EXTEND BEYOND THE DESCRIPTION ON THE FACE HEREOF.
5. **TRANSPORTATION COSTS.** Turbo Air will accept parts covered under this warranty freight collect, provided that shipment has received prior approval. Turbo Air is not responsible for any other transportation costs, but will ship freight collect parts either repaired or replaced under these warranties.
6. **WARRANTY CLAIMS.** All claims should include: model number of the cooler, the serial number of the cabinet, proof of purchase, date of installation, and all pertinent information supporting the existence of the alleged defect. Any action or breach of these warranty provisions must be commenced within one (1) year after that cause of action has accrued.

---

**Turbo air** REFRIGERATOR MANUFACTURER

1250 VICTORIA STREET  
CARSON, CA 90746  
TEL: 310-900-1000  
FAX: 310-900-1077  
TOLL FREE: 1-800-627-0032  
(U.S.A. & Canada)  
<http://www.turboairinc.com>

### **Warranty Claims...**

All claims for parts or labor must be made directly through Turbo Air.

All claims should include: model number of the unit, the serial number of the cabinet, proof of purchase, date of installation, and all pertinent information supporting the alleged defect.

In case of compressor replacement under warranty, either compressor or compressor tag must be returned to Turbo Air along with above listed information.

Failure to comply with warranty policies will result in voiding claims.

### **One Year Parts & Labor Warranty...**

Turbo Air warrants all new refrigerated components, the cabinet and all parts, to be free from defects in materials or workmanship, under normal and proper use and maintenance service as specified by Turbo Air and upon proper installation and start-up in accordance with the instruction packet supplied with each Turbo air unit. Turbo Air's obligation under this warranty is limited to a period of one (1) year from the date of original installation or 15 months after shipment date from Turbo Air, whichever occurs first.

Any part, covered under this warranty, that are by Turbo Air to have been defective within one (1) year of original installation or fifteen (15) months after shipment date from manufacturer, whichever occurs first, is limited to the repair or replacement, including labor charges, of defective parts or assemblies. The labor warranty shall include standard straight time labor charges only and reasonable travel time, as determined by Turbo Air.

### **Additional Four Year Compressor Warranty...**

In addition to the one (1) year warranty stated above, Turbo Air warrants its hermetically sealed compressor to be free from defects in both material and workmanship under normal and proper use and maintenance service for a period of four (4) additional years from the date of original installation, but not to exceed five (5) years and three(3) months after shipment from the manufacturer.

Compressor determined by Turbo Air to have been defective within this extended period will, at Turbo Air's discretion, be either repaired or replaced with a compressor or compressor parts of similar design and capacity.

The four(4) year extended compressor warranty applies only to hermetically sealed parts of the compressor and does not apply to any other parts or components, including, but not limited to, cabinet, paint finish, temperature control, refrigerant, metering device, driers, motor starting equipment, fan assembly or and other electrical components, etcetera.

### **404A / 134a Compressor Warranty...**

The four-year compressor warranty detailed above will be void if the following procedure is not carefully adhered to:

1. This system contains R404A or R134a refrigerant and polyol ester lubricant. The polyol ester lubricant has rapid moisture absorbing qualities.
2. Drier replacement is very important and must be changed when a system is opened for servicing. A620 copper drier or better is highly recommended.
3. Micron level vacuums must be achieved to insure low moisture levels in the system. 500 microns or lower must be obtained.
4. When compressor is grounded, suction drier and 620 drier or better must be replaced.
5. Compressor must be obtained through Turbo Air, unless otherwise specified in writing, through Turbo Air's warranty department.

### **404A / 134a Compressor Warranty...**

Turbo Air's sole obligation under this warranty is limited to either repair or replacement of parts, subject to the additional limitations below. This warranty neither assumes nor authorizes any person to assume obligations other than those expressly covered by this warranty.

NO CONSEQUENTIAL DAMAGES. TURBO AIR IS NOT RESPONSIBLE FOR ECONOMIC LOSS; PROFIT LOSS; OR SPECIAL, INDIRECT, OR CONSEQUENTIAL DAMAGES, INCLUDING WITHOUT LIMITATION, LOSSES, OR DAMAGES ARISING FROM FOOD OR PRODUCT SPOILAGE REGARDLESS OF WHETHER OR NOT THEY RESULT FROM REFRIGERATION FAILURE.

WARRANTY IS NOT TRANSFERABLE, This warranty is not assignable and applies only in favor of the original purchaser/user to whom delivered. ANY SUCH ASSIGNMENT OR TRANSFER SHALL VOID THE WARRANTIES HEREIN AND SHALL VOID ALL WARRANTIES, EXPRESS OR IMPLIED, INCLUDING ANY WARRANTY OF MERCHANTABILITY OR LABOR COVERAGE FOR COMPONENT FAILURE OR OTHER THE WARRANTY PACKET PROVIDED WITH THE UNIT.

ALTERATION, NEGLIGENCE, ABUSE, MISUSE, ACCIDENT, DAMAGE DURING TRANSIT OR INSTALLATION, FIRE, FLOOD, ACTS OF GOD. Turbo Air is not responsible for the repair or replacement of any parts that Turbo Air determines have been subjected after the date of manufacture to alteration, neglect, abuse, misuse, accident, damage during transit or installation, fire, flood, or act of GOD.

IMPROPER ELECTRICAL CONNECTIONS. TURBO AIR IS NOT RESPONSIBLE FOR THE REPAIR OR REPLACEMENT OF FAILED OR DAMAGED COMPONENTS RESULTING FROM ELECTRICAL POWER FAILURE, THE USE OF EXTENSION CORDS, LOW VOLTAGE, OR VOLTAGE DROPS TO THE UNIT. NO IMPLIED WARRANTY OF MERCHANTABILITY OR FITNESS FOR A PARTICULAR PURPOSE; THERE ARE NO OTHER WARRANTIES, EXPRESSED, IMPLIED OR STATUTORY, EXCEPT THE ONE (1) YEAR PARTS & LABOR WARRANTY AND THE ADDITIONAL FOUR (4) YEAR COMPRESSOR WARRANTY AS DESCRIBED ABOVE. THESE WARRANTIES ARE EXCLUSIVE AND IN LIEU OF ALL OTHER WARRANTIES, INCLUDING IMPLIED WARRANTY AND MERCHANTABILITY OR FITNESS FOR A PARTICULAR PURPOSE. THERE ARE NO WARRANTIES, WHICH EXTEND BEYOND THE DESCRIPTION ON THE FACE HEREOF.

Outside U.S.and Canada; This warranty does not apply to, and Turbo Air is not responsible for, any warranty claims made on products sold or used outside the continent of the United States and Canada.

CHANGES MADE TO WARRANTY COMMENCED ON 11/01/2007