

The Samsung logo is located in the top right corner of the page. It consists of the word "SAMSUNG" in a bold, white, sans-serif font, centered within a dark, horizontally-oriented oval shape.

**SAMSUNG**

# E-MANUAL

Thank you for purchasing this Samsung product.  
To receive more complete service, please register  
your product at

[www.samsung.com/register](http://www.samsung.com/register)

Model \_\_\_\_\_ Serial No. \_\_\_\_\_

# Contents

## Quick Guides

### Using Smart Hub

- 1 Connecting to the Internet
- 1 Setting up Smart Hub
- 1 Using Smart Hub

### Controlling the TV with Your Voice

- 2 Setting up Voice Recognition
- 2 Controlling the TV with your voice

### Controlling the TV with Motion

- 3 Setting up Motion Control
- 3 Controlling the TV using motions

### Using the Samsung Smart Control

- 4 Operating the TV with the POINTER button
- 5 Setting up the Samsung Smart Control
- 5 Pairing the TV to the Samsung Smart Control

### Improving Your Viewing Experience of Sports Events

- 6 Activating sports mode

### Displaying Multiple Screens

## Connections

### Connecting an Antenna

### Connecting to the Internet

- 9 Establishing a wired Internet connection
- 10 Establishing a wireless Internet connection

### Troubleshooting Internet Connectivity Issues

- 12 Troubleshooting wired Internet connectivity issues
- 13 Troubleshooting wireless Internet connectivity issues

### Connecting Video Devices

- 14 Connecting with an HDMI cable
- 15 Connecting with a component cable
- 16 Connecting with a composite (A/V) cable

### Audio Input and Output Connections

- 17 Connecting with an HDMI (ARC) cable
- 18 Connecting with a digital audio (optical) cable
- 18 Connecting with a stereo audio cable

### Connecting a Computer

- 19 Connecting through the HDMI port
- 20 Connecting with an HDMI-to-DVI cable
- 20 Connecting through your home network

### Connecting a Mobile Device

- 21 Connecting with an MHL-to-HDMI Cable
- 22 Using Screen Mirroring
- 23 Connecting mobile devices without a wireless router (Wi-Fi Direct)
- 24 Connecting a mobile device via Samsung Smart View 2.0

### Pairing a laptop to the TV (wireless PC mirroring)

### Switching between external devices connected to the TV

### Connection Notes

- 26 Connection notes for HDMI
- 27 Connection notes for audio devices
- 27 Connection notes for computers
- 27 Connection notes for mobile devices
- 28 Connection notes for wireless PC mirroring

# Remote Control and Peripherals

## About the Samsung Smart Control

### Using the Samsung Smart Control

- 31 Operating the TV with the POINTER button
- 31 Operating the TV with the directional buttons and the Enter button
- 32 Displaying and using the On-Screen Remote
- 33 Pairing the TV to the Samsung Smart Control

### Controlling External Devices with the TV Remote - Using the Universal Remote

- 34 Setting up the universal remote control

### Controlling the TV with a Keyboard

- 35 Connecting a keyboard
- 36 Using the keyboard

### Controlling the TV with a Mouse

- 37 Connecting a mouse
- 37 Using a mouse

### Connecting a Bluetooth Gamepad

### Entering Text using the On-Screen QWERTY Keyboard

- 38 Using additional functions

# Smart Features

## Viewing Multiple Screens or Features with Multi-Link Screen

- 39 Using Multi-Link Screen

## Smart Hub

- 41 Removing or pinning an item in the Recent group
- 41 Launching Smart Hub automatically
- 41 Testing Smart Hub connections
- 42 Using the Smart Hub tutorial
- 42 Resetting Smart Hub

## Using Smart Hub with a Samsung Account

- 43 Creating a Samsung account
- 44 Signing in to a Samsung account
- 44 Linking your Samsung account to external service accounts
- 45 Changing and adding information to a Samsung account
- 45 Deleting a Samsung account from the TV

## Using the GAMES Service

- 46 Managing games with the pop-up Options menu
- 46 Viewing the Detailed Information screen
- 47 Installing and running a game
- 47 Managing downloaded or purchased games

## Using the APPS Service

- 49 Managing Apps with the pop-up Options menu
- 49 Viewing the Detailed Information screen
- 50 Installing an app
- 50 Enabling automatic apps updates
- 51 Removing an app from the TV
- 51 Locking and unlocking apps
- 51 Updating apps
- 51 Rearranging apps
- 51 Rating purchased apps
- 51 Using other app features and functions

## Using the e-Manual

- 52 Launching the e-Manual
- 52 Using the buttons in the e-Manual

## Using the Web Browser

- 53 Browsing preferences

## Using the MY CONTENT Service

- 54 Read before playing media content
- 55 Playing multimedia content in a computer or mobile device
- 55 Playing media content saved on a USB device
- 56 Buttons and functions available while viewing photos
- 57 Buttons and functions available while viewing videos
- 59 Buttons and functions available while playing music
- 60 Functions on the media content list screen

## Using the NewsON Service

- 61 Using the NewsON content

## Using the Soccer Service

- 62 Configuring the Soccer service screen to display your favorite soccer teams
- 62 Using additional functions
- 63 Viewing soccer videos

## Controlling the TV with Your Voice

- 65 Read before using voice recognition
- 65 Learning voice recognition basics
- 66 Using interactive voice recognition at a short distance
- 66 Using the voice recognition tutorial

## Controlling the TV using Motions (Motion Control)

- 67 Testing ambient illumination using the TV camera
- 68 Activating motion control
- 70 Changing the motion control screens

## Using Face Recognition

- 72 Registering your face to your Samsung account
- 73 Changing your login method to face recognition
- 73 Signing in to a Samsung account using face recognition

# TV Viewing

## Viewing Digital Broadcast Information at a Glance

- 74 Using the guide
- 75 Checking current program info
- 75 Changing the broadcast signal
- 75 Checking digital channel signal info and strength

## Recording Programs

- 76 Recording programs
- 77 Using the functions available while recording a program
- 77 Using the buttons on the remote control while recording a program
- 77 Managing the schedule recording list
- 78 Viewing recorded programs
- 80 Managing recorded files

## Setting Up a Schedule Viewing

- 81 Setting up a schedule viewing for a channel
- 81 Editing a schedule viewing
- 81 Canceling a schedule viewing

## Using Timeshift

- 82 Using the buttons on the remote control while using Timeshift

## Using the Channel List

### Registering, Removing, and Editing Channels

- 84 Registering and removing channels
- 85 Editing registered channels
- 86 Using Program Rating Lock

### Creating a Personal Favorites List

- 89 Registering channels as favorites
- 89 Viewing and selecting channels on Favorites lists only

### Editing a Favorites List

- 90 Using the Edit Favorites screen menu items

### Making Sports Programs More Realistic with Sports Mode

- 92 Enabling sports mode
- 92 Extracting highlights automatically
- 93 Using the functions available while watching sports in sports mode
- 93 Using the functions available while recording sports in sports mode
- 94 Viewing a game recorded in sports mode

### Making Sports Programs More Realistic with Hockey Mode

### TV-Viewing Support Functions

- 95 Showing captions
- 97 Enabling the audio guide for the video description
- 97 Scanning for available channels
- 97 Selecting the broadcast audio language
- 98 Fine-tuning analog broadcasts
- 98 Removing pay channels

## Picture and Sound

### Adjusting the Picture Quality

- 99 Choosing a picture mode
- 100 Adjusting the picture quality
- 101 Adjusting advanced settings
- 102 Adjusting picture options

### Viewing in 3D

- 104 Starting 3D
- 105 Adjusting 3D effects

### Picture Support Functions

- 106 Viewing a picture-in-picture (PIP)
- 107 Changing the picture size and position
- 108 Listening to audio only (Picture Off)
- 108 Resetting the picture mode settings

### Adjusting the Sound Quality

- 109 Choosing a sound mode
- 110 Applying sound effects

### Using the Sound Support Functions

- 111 Selecting speakers
- 111 Specifying the TV's installation type
- 111 Listening to TV sound through a Samsung Bluetooth audio device
- 112 Listening to TV sound through a Samsung Multiroom Link compatible speaker
- 113 Listening to the TV through Bluetooth headphones
- 113 Enabling digital audio output
- 114 Listening to 3D audio in 3D mode
- 114 Resetting all sound settings

## System and Support

### Setting the Time and Using the Timer

- 115 Setting the current time
- 116 Using the timers

### Using the Screen Burn Protection and Energy Saving Functions

- 118 Preventing screen burn
- 118 Reducing the energy consumption of the TV

### Using Anynet+ (HDMI-CEC)

- 119 Setting up Anynet+ (HDMI-CEC)
- 119 Using Anynet+ (HDMI-CEC)

### Updating the TV's Software

- 121 Updating the TV's software to the latest version
- 121 Updating the TV automatically

### Protecting the TV from Hacking and Malicious Code

- 122 Checking the TV and connected storage for malicious code
- 123 Configuring additional functions

### Using Other Functions

- 124 Running the accessibility functions quickly
- 124 Enabling voice guides for the visually impaired
- 125 White text on black background (high contrast)
- 125 Adjusting the menu transparency
- 125 Enlarging the font (for the visually impaired)
- 125 Learning about the remote control (for the visually impaired)
- 125 Listening to the TV through Bluetooth headphones (for the hearing impaired)
- 126 Changing the menu language
- 126 Setting up a password
- 126 Checking Notifications
- 126 Enabling game mode
- 127 Richer colors and superior picture quality (BD Wise)
- 127 Enabling/Disabling sound feedback
- 127 Locking/Unlocking the Control Stick
- 127 Showing/Hiding the Samsung logo while booting
- 127 Enabling the TV to boot faster
- 128 Registering the TV as a DivX-certified device (watching for pay DivX movies)
- 128 Restoring the TV to the factory settings
- 128 Using the TV as a display model (for retail stores)

# Troubleshooting

## Getting Support

- 129 Getting support through Remote Management
- 130 Finding the contact information for service
- 130 Requesting service

## There Is a Problem with the Picture

- 131 Testing the picture

## I Can't Hear the Sound Clearly

- 133 Testing the sound

## I Can't See 3D Images Clearly

- 134 Testing 3D picture quality

## There Is a Problem with the Broadcast

## My Computer Won't Connect

## The TV Won't Connect to the Internet

## The Schedule Recording/Timeshift Function Isn't Working

## Anynet+ (HDMI-CEC) Isn't Working

## I Have Trouble Launching/Using Apps

## My File Won't Play

## I Want to Reset the TV

## Other Issues

# Precautions and Notes

## Before Using the Recording and Timeshift Functions

- 140 Before using the recording and schedule recording functions
- 141 Before using the timeshift function

## Read Before Using 3D Mode

- 142 3D precautions

## Supported Resolutions for 3D Modes

## Supported Resolutions for each of UHD Input Signals

- 146 If HDMI UHD Color is set to Off
- 146 If HDMI UHD Color is set to On

## S Recommendation disclaimer

- 147 S Recommendation with voice interaction
- 147 S Recommendation

## Read Before Using Voice, Motion, or Face Recognition

- 148 Precautions for voice, motion, and face recognition
- 149 Requirements for using voice, motion, or face recognition

## Read Before Using Apps

## Read Before Using the Web Browser

## Read Before Playing Photo, Video, or Music Files

- 153 Limitations on use of photo, video, and music files
- 154 Supported external subtitles
- 154 Supported internal subtitles
- 155 Supported image formats and resolutions
- 155 Supported music formats and codecs
- 156 Supported video codecs

## Read After Installing the TV

- 158 Picture sizes and input signals
- 158 Installing an anti-theft lock
- 159 Read before setting up a wireless Internet connection

## Read Before Connecting a Computer (Supported Resolutions)

- 160 IBM
- 160 MAC
- 161 VESA DMT

## Supported Resolutions for Video Signals

- 162 CEA-861

## Read Before Using Bluetooth Devices

- 163 Restrictions on using Bluetooth

## License

## Glossary

# Using Smart Hub

## Connecting to the Internet

(MENU/123) > MENU > Network > Network Settings

Connect the TV to the Internet. You can use a wired or wireless connection.

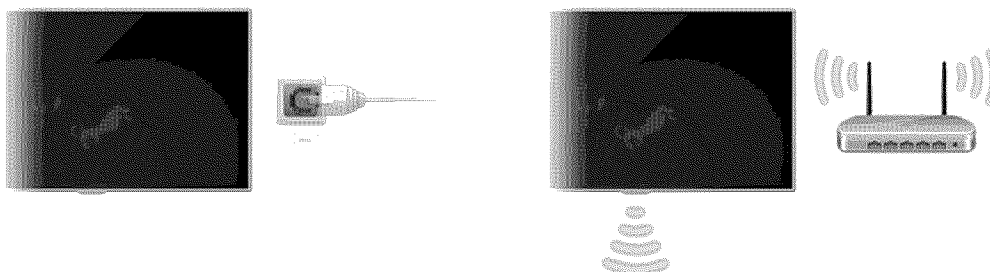

## Setting up Smart Hub

Press the  button on your remote control. When you start Smart Hub for the first time, the Set Up Smart Hub screen appears. Follow the instructions on the screen to configure the required settings and complete the setup.



## Using Smart Hub

Enjoy the multiple functions provided by Smart Hub simultaneously on a single screen.

 For more information, refer to "Smart Hub."

# Controlling the TV with Your Voice

 This function is only supported for the 6700 to 8500 and 670D to 850D series models.

## Setting up Voice Recognition

(MENU/123) > MENU > System > Voice Recognition

Configure the settings required for voice recognition, such as selecting the language to use and whether to use TV Voice.

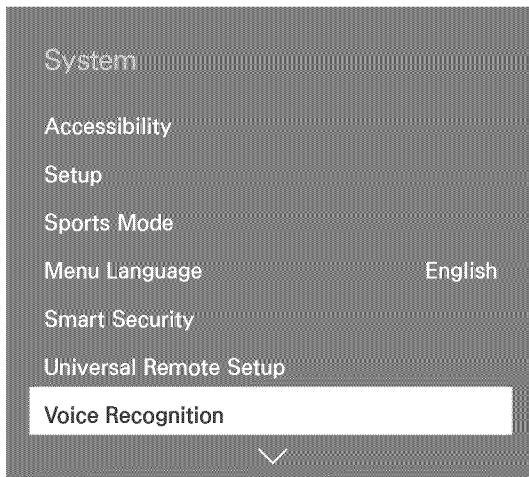

 Your TV's menu may differ from the image above, depending on the model.

## Controlling the TV with your voice

Press and hold the MENU/123 button on the Samsung Smart Control. The Voice Recognition screen appears. When the Voice Recognition icon appears on the screen, say commands slowly into the microphone on the Samsung Smart Control in a moderately loud voice.

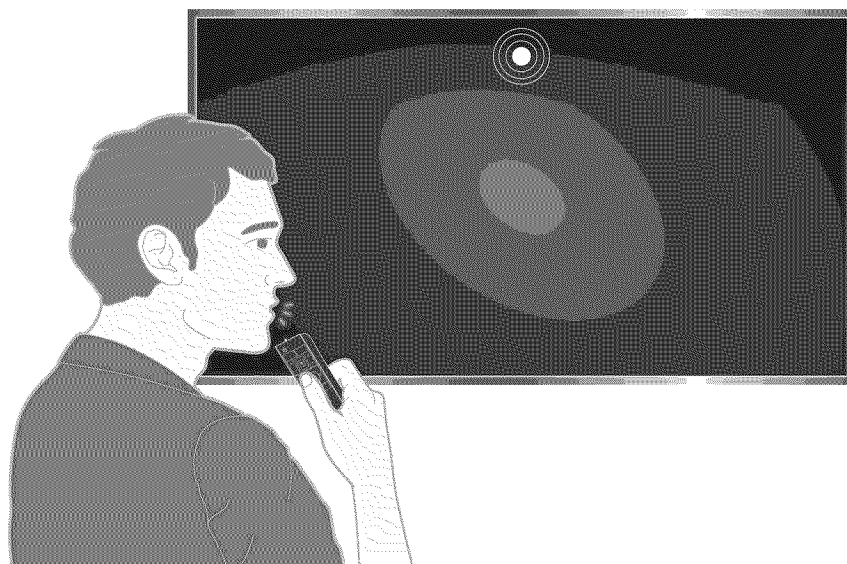

 This function is not available on certain models in specific geographical areas.

 The Samsung Smart Control may not be provided with specific model and country.

 For more information, refer to "Controlling the TV with Your Voice."

# Controlling the TV with Motion

## Setting up Motion Control

(MENU/123) > MENU > System > Motion Control

Perform the Motion Control Environment Test, and then configure the settings required to run Motion Control, such as adjusting the Pointer Speed and deciding whether to display the Animated Motion Guide.

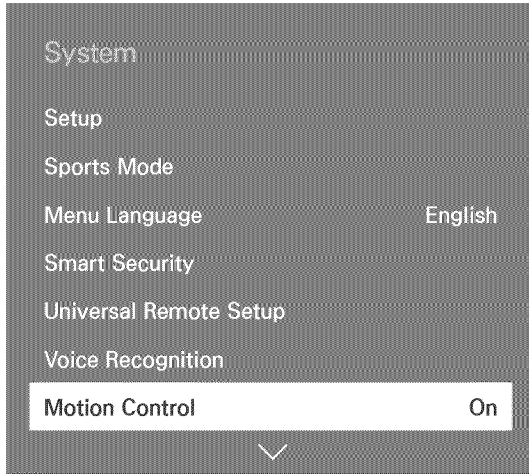





 Your TV's menu may differ from the image above, depending on the model.

## Controlling the TV using motions

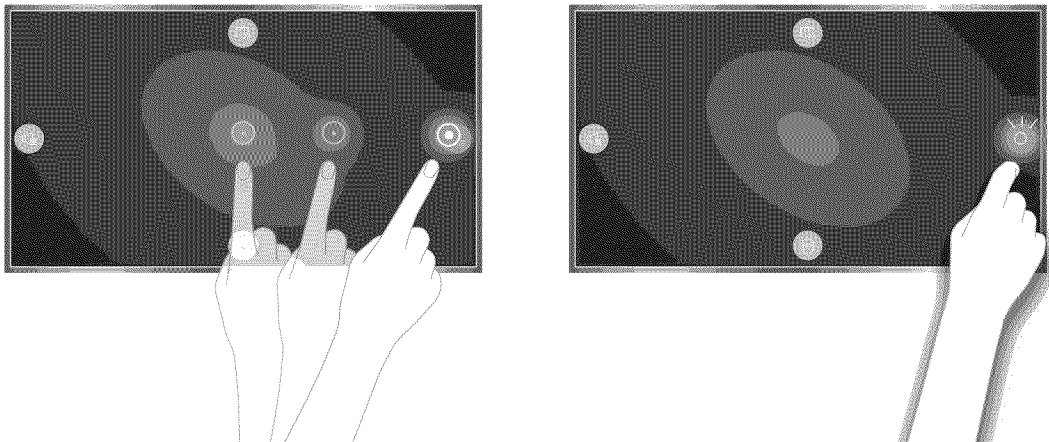
(MENU/123) > MENU > System > Motion Control > Motion Control

1. Set Motion Control to On.
2. Face the TV camera, raise your hand to a comfortable position, fully extended your index finger upwards, and then move your index finger slowly to the left or right.
3. Curl your index finger down to select a function, and then raise it again to run the selected function.



-  Motion Control is available in either direction control or motion pointing mode.
-  To use **Motion Control**, you must connect a TV camera (sold separately) to the TV.
-  For more information, refer to "Controlling the TV using Motions (Motion Control)."



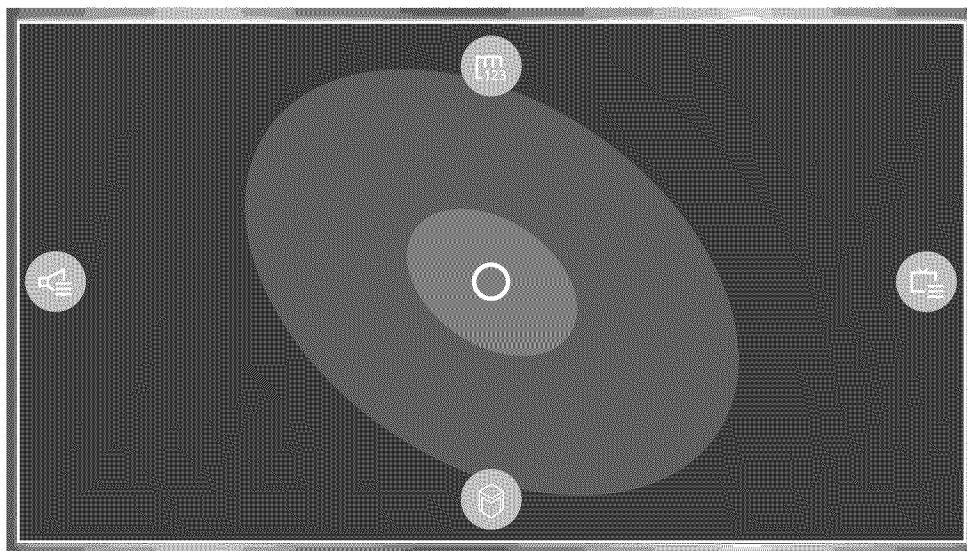

# Using the Samsung Smart Control

 The Samsung Smart Control is provided with the 6700 to 8500 and 670D to 850D series models. And it may not be provided with the 6700 series model in specific countries.

## Operating the TV with the POINTER button



Place a finger on the **POINTER** button and move the Samsung Smart Control. The pointer on the screen moves in the direction you moved the Samsung Smart Control. Move the pointer to one of the following icons on the screen, and then press the **POINTER** button.

-  : Displays the On-Screen Remote.
-  : Allows you to adjust the volume or select speakers.
-  : Displays the channel list.
-  : Launches Smart Hub.

# Setting up the Samsung Smart Control

(MENU/123) > MENU > System > Smart Control Settings

Configure the basic settings for using the Samsung Smart Control.

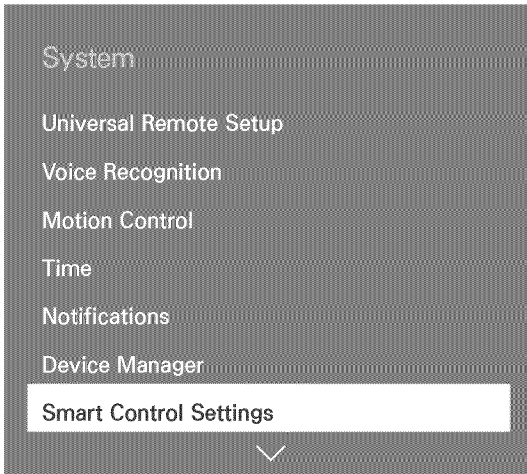

## Pairing the TV to the Samsung Smart Control

When you turn on the TV for the first time, the Samsung Smart Control pairs to the TV automatically. If the Samsung Smart Control does not pair to the TV automatically, point it at the remote control sensor of the TV, and then press and hold the buttons labeled ① and ② in the diagram on the left simultaneously for 3 seconds or more.

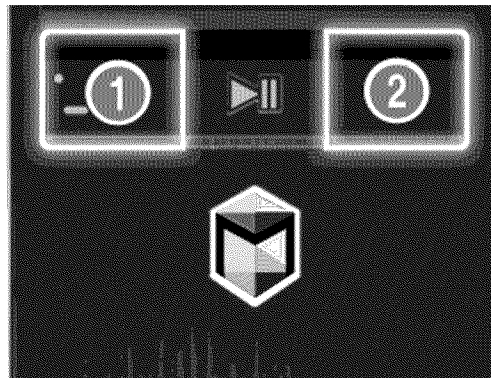





# Improving Your Viewing Experience of Sports Events

## Activating sports mode

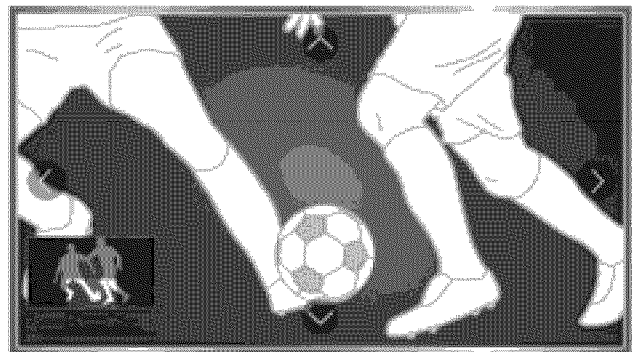
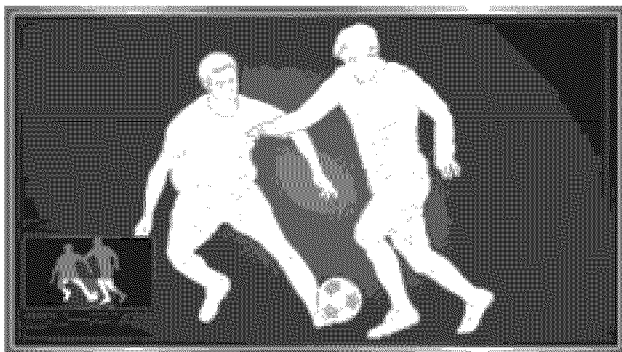
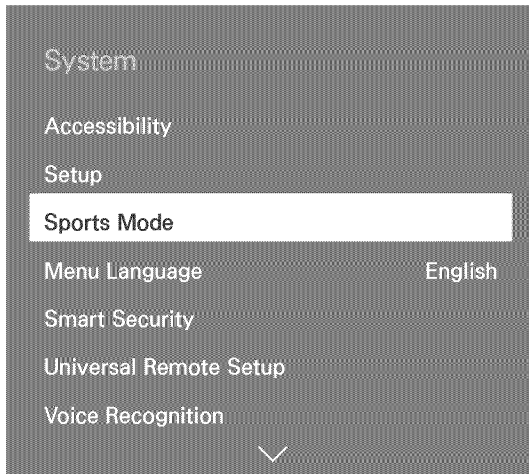
(MENU/123) > MENU > System > Sports Mode or Soccer Mode

Set Sports Mode to On. The TV automatically configures the picture and sound settings so that they are suitable for soccer matches.





-  You can zoom in the screen while you are using the sports mode. Move the focus to the part of screen to magnify.
-  Your TV's menu may differ from the image above, depending on the model.
-  The actual name may differ with specific geographical area.
-  For more information, refer to "[Making Sports Programs More Realistic with Sports Mode.](#)"

# Displaying Multiple Screens

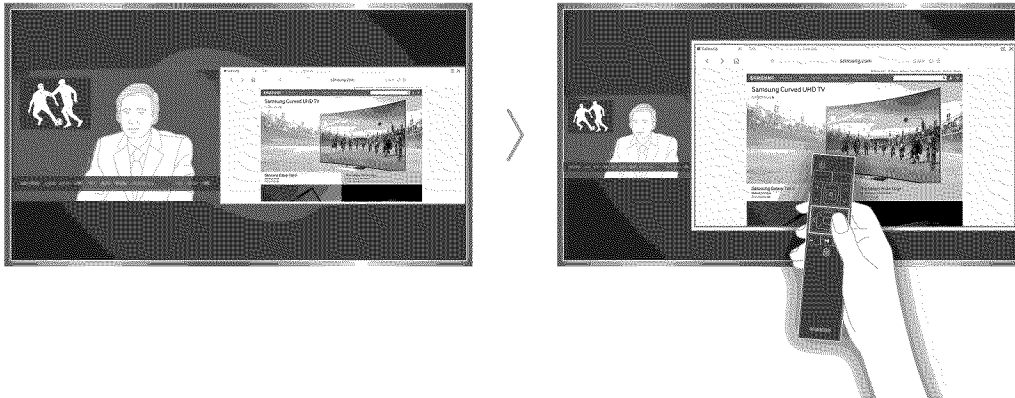
You can surf the web or run an app while viewing the TV. You can change the size of each screen by dragging the circle in the middle of the screen to the left or right.



-  The image of the remote control may differ with the TV model.
-  For more information, refer to "Viewing Multiple Screens or Features with Multi-Link Screen."

# Connecting an Antenna

Connect a cable from an antenna or cable wall outlet to the ANT IN connector, as shown in the image below to receive broadcast signals.

 An antenna connection is not necessary if you connect a cable box or satellite receiver.

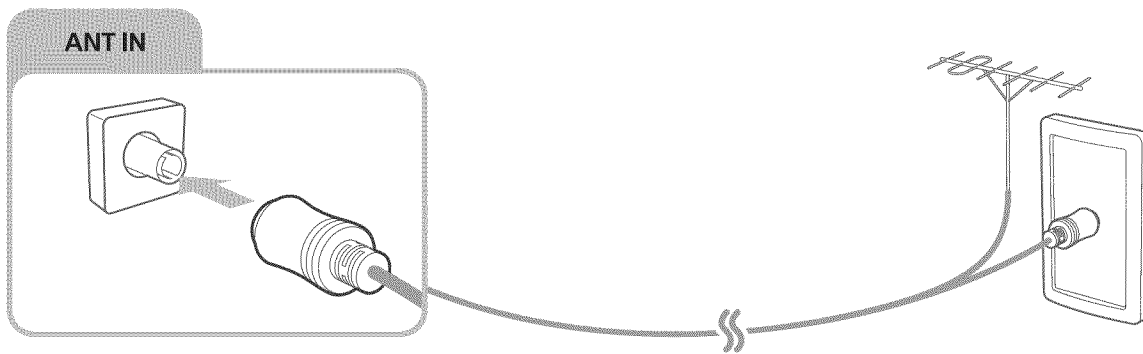

# Connecting to the Internet

## Establishing a wired Internet connection

### Using LAN cables

There are three ways to connect the TV to your Internet access points, as shown in the following illustrations:

- Wall-mounted LAN Outlet

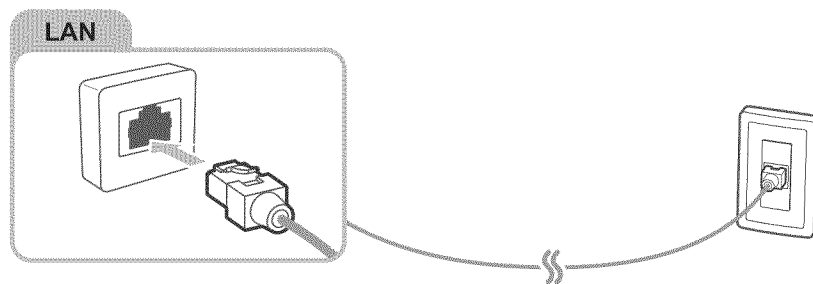

- External Modem

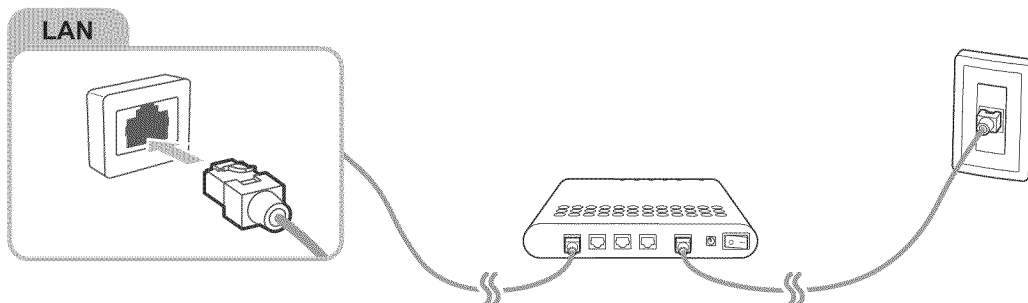

- ① IP Router + ② External Modem

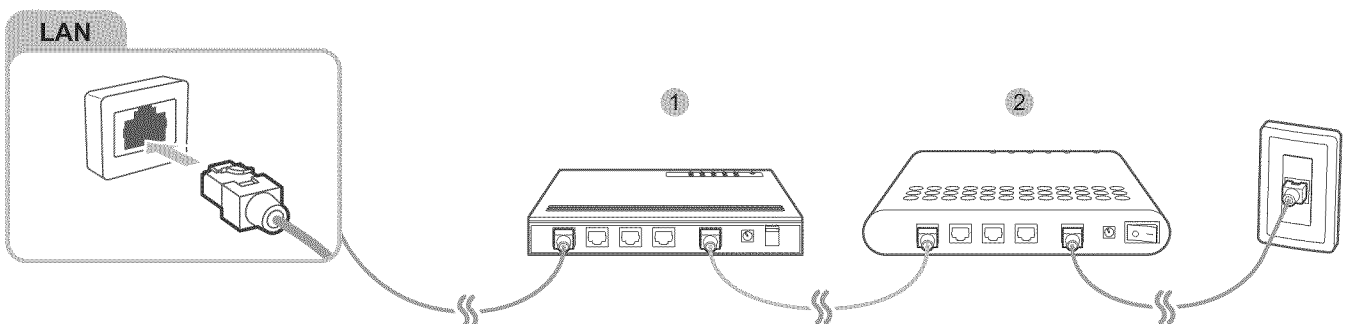

 We recommend using Cat 7 LAN Cables to link your TV to the Internet Access Points.

 The TV will not be able to connect to the Internet if the network speed is below 10Mbps.

## Connecting to a wired Internet network automatically

(MENU/123) > MENU > Network > Network Settings **Try Now**

Automatically connect to an available network.

1. Select **Wired**.
2. Once the network connection has been made, you will see a confirmation message. If the connection fails, try again or connect manually.

## Establishing a wireless Internet connection

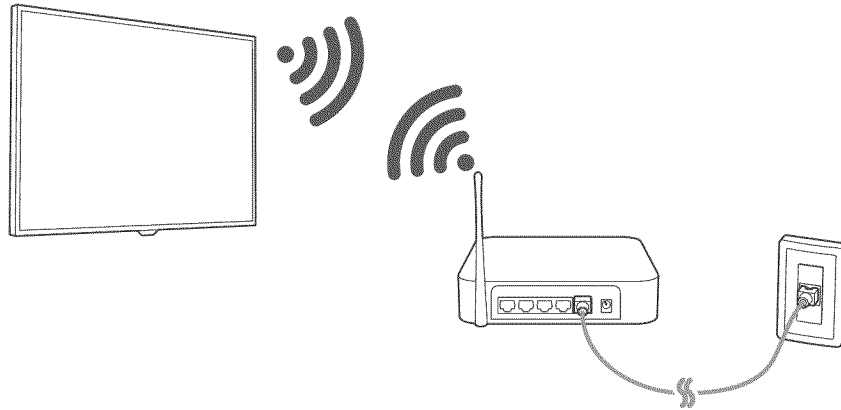

## Connecting to a wireless Internet network automatically

(MENU/123) > MENU > Network > Network Settings

Make sure that you have the wireless router's SSID (name) and password settings before attempting to connect.

1. Select **Wireless**. The TV automatically displays a list of available wireless networks.
2. Select a network. If the network you want doesn't appear in the list, the screen returns to the Network Settings screen.
3. If your network is security enabled, enter the password using the displayed on-screen keyboard. If your network is not security-enabled, the TV will bypass the on-screen keyboard and attempt to connect right away.

## Connecting to a wireless Internet network with WPS

(MENU/123) > MENU > Network > Network Settings

If your router has a WPS (Wi-Fi protected setup) push button, you can use it to connect the TV to the router automatically.

1. Select **Wireless**. The TV automatically displays a list of available wireless networks.
2. Select **Stop** and then select **WPS (PBC)**.
3. Press the WPS or PBC button on your wireless router within the next two minutes.
4. The TV connects to the network automatically.

## Checking the Internet connection status

(MENU/123) > MENU > Network > Network Status [Try Now](#)



 Your TV's menu may differ from the image above, depending on the model.

View the current network and Internet status.

## Changing the name of the TV on a network

(MENU/123) > MENU > Network > Device Name [Try Now](#)

You can change the device name of the TV. This is the name that will appear on mobile devices and computers connected to your network.

1. Select **Device Name** from the **Network** menu.
2. Select a name from the list that appears. Alternatively, select **User Input** to enter a name manually.

# Troubleshooting Internet Connectivity Issues

## Troubleshooting wired Internet connectivity issues [Try Now](#)

### No network cable found

Make sure that the network cable is plugged in. If it is connected, make sure that the router is turned on. If it is on, try turning it off and on again.

### IP auto setting failed

Do the following or configure the **IP Settings** manually.

1. Make sure that the DHCP server is enabled on the router, and then reset the router.
2. If the problem persists, contact your Internet Service Provider.

### Unable to connect to the network

1. Check all **IP Settings**.
2. Make sure that the DHCP server is enabled on the router. Then, unplug the router and plug it back in.
3. If this does not work, contact your Internet Service Provider.

### Connected to a local network, but not to the Internet

1. Make sure that the Internet LAN cable is connected to the router's external LAN port.
2. Check the DNS values in **IP Settings**.
3. If the problem persists, contact your Internet Service Provider.

### Network setup is complete, but unable to connect to the Internet

If the problem persists, contact your Internet Service Provider.

# Troubleshooting wireless Internet connectivity issues

## Wireless network connection failed

If a selected wireless router is not found, go to **Network Settings** and select the correct router.

## Unable to connect to a wireless router

1. Check if the router is turned on. If it is, turn it off and on again.
2. Enter the correct password if required.

## IP auto setting failed

Do the following or configure the **IP Settings** manually.

1. Make sure that the DHCP server is enabled on the router. Then, unplug the router and plug it back in.
2. Enter the correct password if required.
3. If the problem persists, contact your Internet Service Provider.

## Unable to connect to the network

1. Check all **IP Settings**.
2. Enter the correct password if required.
3. If the problem persists, contact your Internet Service Provider.

## Connected to a local network, but not to the Internet

1. Make sure that the Internet LAN cable is connected to the router's external LAN port.
2. Check the DNS values in **IP Settings**.
3. If the problem persists, contact your Internet Service Provider.

## Network setup is complete, but unable to connect to the Internet

If the problem persists, contact your Internet Service Provider.

# Connecting Video Devices

Your TV has a variety of connections for video input from external devices. Below is a list of featured connections shown in descending order of picture quality.

- HDMI
- Component
- Composite (A/V)

Connect a video device to the TV with an HDMI connection for the best picture quality. If the device does not have an HDMI connection, try a component connection.

## Connecting with an HDMI cable

The following types of HDMI cables are recommended:

- High-Speed HDMI Cable
- High-Speed HDMI Cable with Ethernet

Connect the HDMI cable to the HDMI output connection of the video device and the HDMI input connection of the TV as shown in the image below.

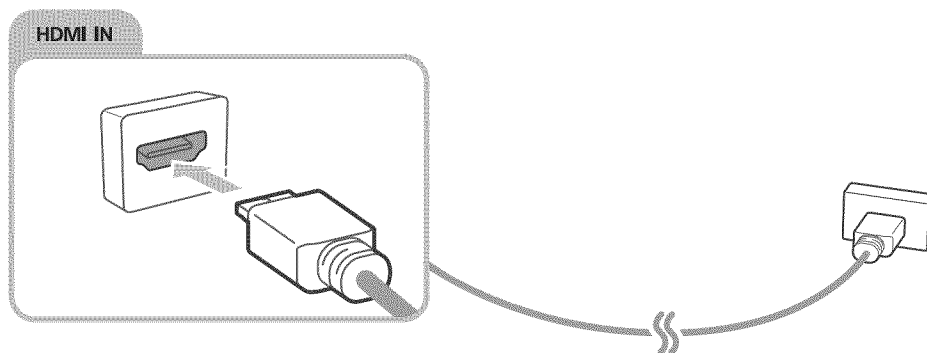

## Connecting with a component cable

Connect the component cable to the component input connections of the TV and the component output connections of the device using the AV adapter as shown in the image below. Make sure to connect the same color connectors together (red to red, blue to blue, etc.)

For the 6400 to 6700 series models

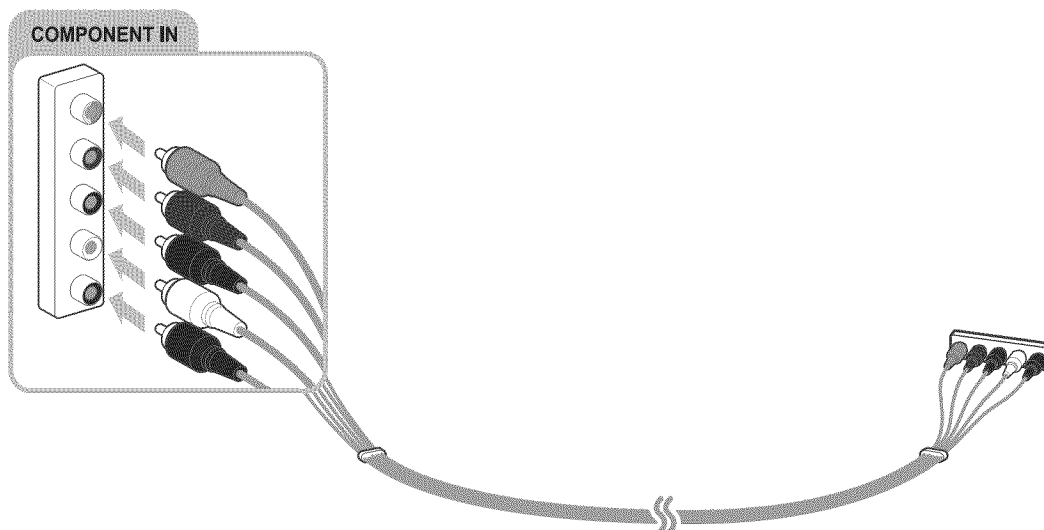

For the 7100 to 8500 series models

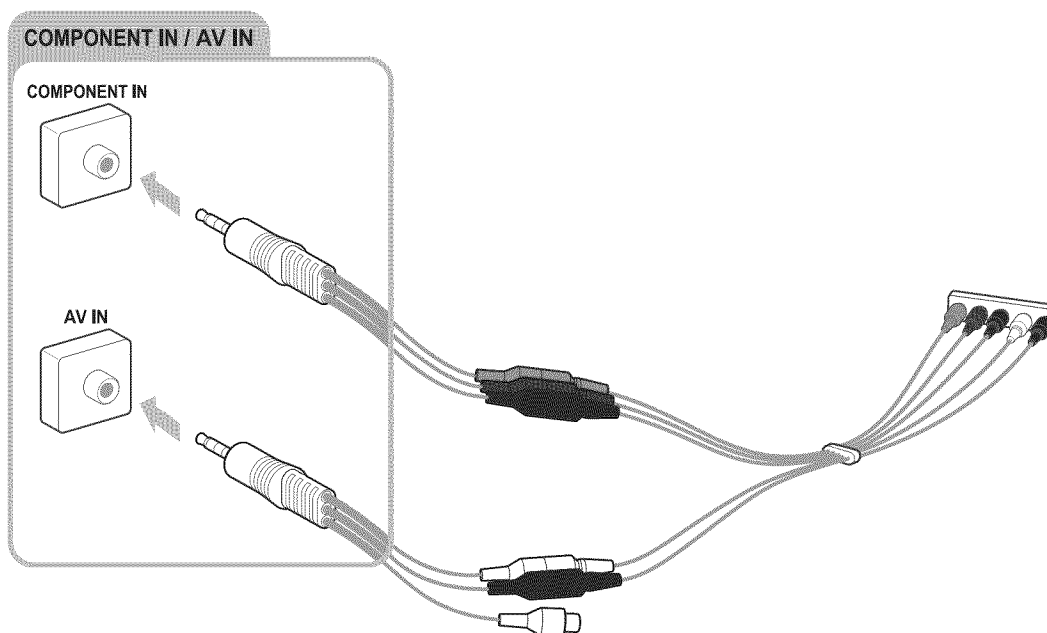

## Connecting with a composite (A/V) cable

Connect the AV cable to the input connections of the TV and the AV output connections of the device as shown in the image below. If you are using the AV IN connection on the TV, connect the AV cable to the AV IN connection on the TV and the AV output connections of the device. Make sure to connect the same color connectors together (red to red, white to white, and yellow to yellow)

For the 6400 to 6700 series models

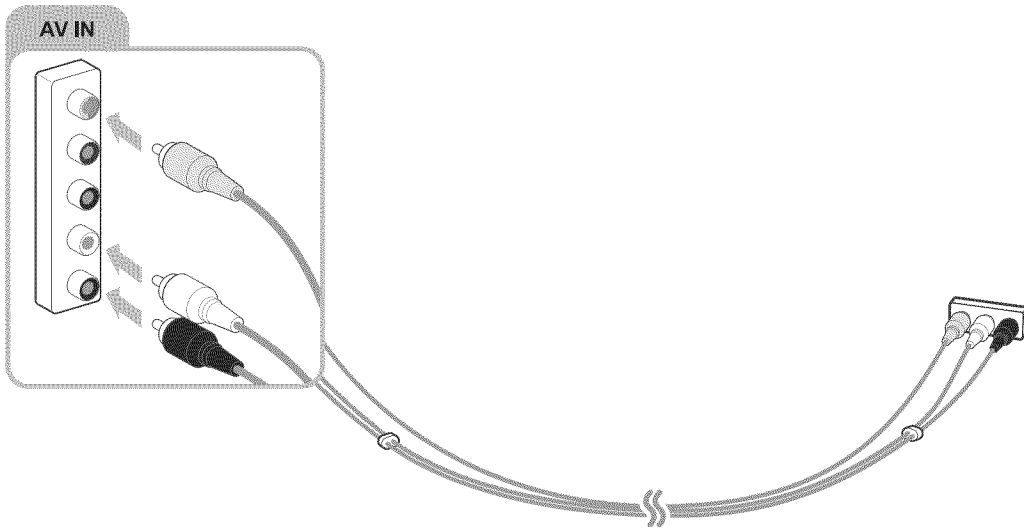

For the 7100 to 8500 series models

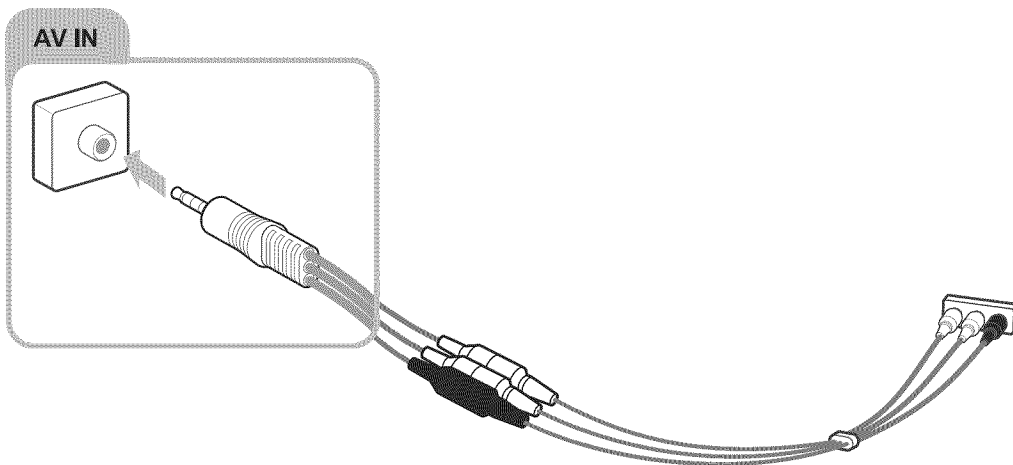

# Audio Input and Output Connections

Your TV has a variety of connections for audio input from external devices. The connections are listed below.

- HDMI/ARC (Audio Return Channel)
- Digital Audio (Optical)
- Audio (Analog)

## Connecting with an HDMI (ARC) cable

ARC (Audio Return Channel) lets the TV output digital sound to an audio device and input digital sound from the same audio device through one HDMI cable. ARC is only available through the HDMI (ARC) port and only when the TV is connected to an ARC-enabled AV receiver.

Connect an HDMI cable to the HDMI (ARC) input connection of the TV and the ARC-enabled HDMI output connection of the device as shown in the image below.

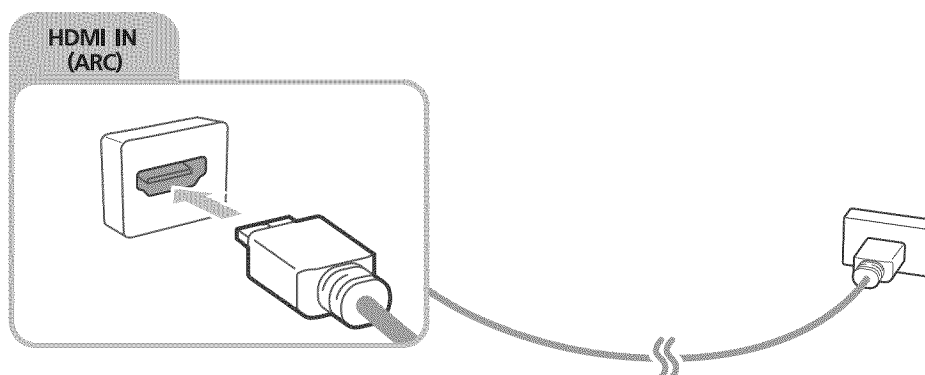

## Connecting with a digital audio (optical) cable

You can listen to digital audio by connecting an AV receiver to the TV via a digital audio (optical) cable.

Connect the optical cable to the digital audio output connection of the TV and the digital audio input connection of the receiver as shown in the image below.

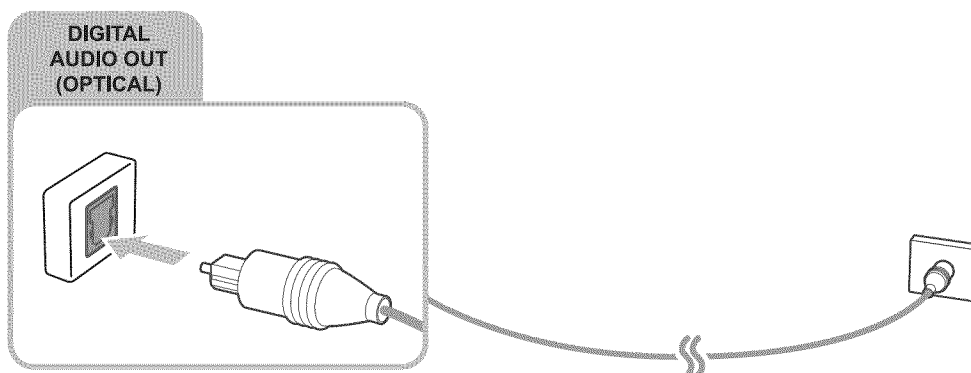

## Connecting with a stereo audio cable

Connect a stereo audio cable to the audio output connection of the TV and the audio input connection of the device as shown in the image below.

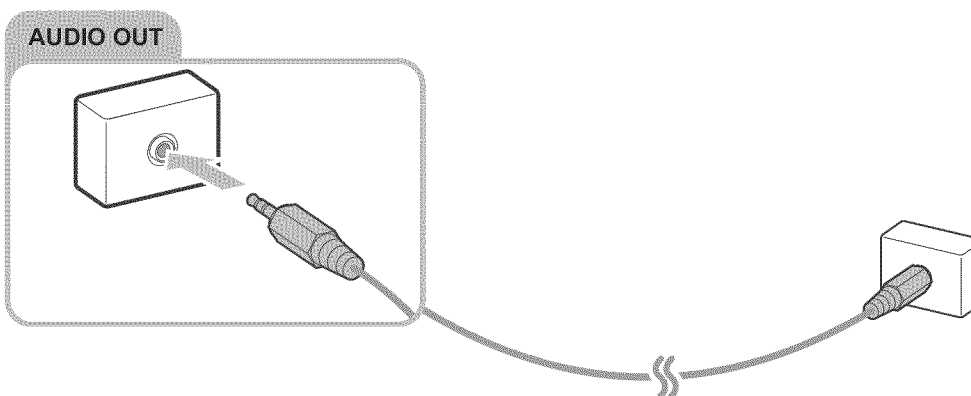

# Connecting a Computer

The kinds of connections you can make are listed below.

## To use the TV as a computer monitor

- Connect through the HDMI port with an HDMI cable.
- Connect through the HDMI (DVI) port with an HDMI-to-DVI cable.

## To view or play the content saved in a computer on the TV

- Connect through your home network.

## Connecting through the HDMI port

For an HDMI connection, we recommend one of the following HDMI cable types:

- High-Speed HDMI Cable
- High-Speed HDMI Cable with Ethernet

Connect an HDMI cable to the HDMI input connection of the TV and the HDMI output connection of the computer as shown in the image below.

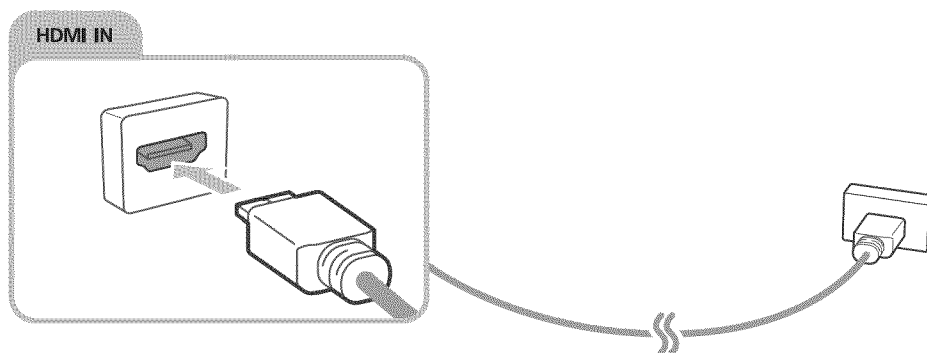

- ✎ Set **Edit Device Type** to **DVI PC** for a computer connected with a HDMI-to-DVI cable, and **PC** for a computer connected with HDMI cable. Also, set **Edit Device Type** to **DVI Devices** for an A/V device with a HDMI-to-DVI cable.

## Connecting with an HDMI-to-DVI cable

If the graphics adapter of your TV does not support the HDMI interface, connect the computer to the TV with a DVI (Digital Visual Interactive)-to-HDMI cable. Note that the HDMI-to-DVI connection is only supported by the HDMI (DVI) port and does not transmit audio. To listen to the computer sound, connect external speakers to the audio output connection of the computer.

Connect the HDMI-to-DVI cable to the HDMI (DVI) port of the TV and the DVI output port of the computer as shown in the image below.

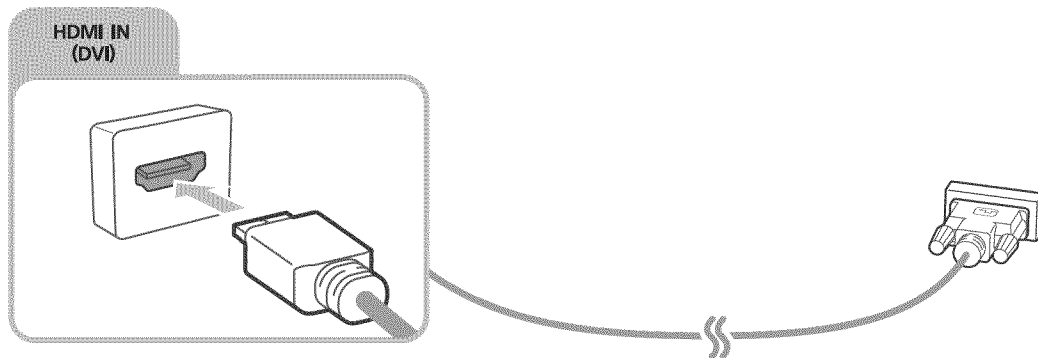

## Connecting through your home network

You can quickly access and play photo, video, and music files stored on a computer on the TV.

1. Connect the TV and the computer to the same router or AP. If you connected your TV to your network when you set up your TV, this is already done.
2. On the computer, select [Control Panel] [Network and Internet] [Network and Sharing Center] [Change advanced sharing settings], and select [Choose media streaming options...] to activate media streaming.
3. On the list of available devices displayed by the computer, set the TV to [Allowed].

 For more information about playing content, refer to "Playing multimedia content in a computer or mobile device."

# Connecting a Mobile Device

You can connect a mobile device such as a smartphone or tablet directly to the TV, or connect it to your network and display the mobile device's screen or play its content on the TV. The kinds of connections you can make are listed below.

- Connect by using an MHL-to-HDMI cable and view the mobile device's screen on the TV.
- Connect by mirroring the mobile device's screen on the TV (Screen Mirroring).
- Connect mobile devices without a wireless router (Wi-Fi Direct).
- Connect a mobile device via Samsung Smart View 2.0.

## Connecting with an MHL-to-HDMI Cable

You can use the Mobile High-definition Link (MHL) function to display a mobile device's screen on the TV. However, MHL is only available through the TV's HDMI (MHL) port and only when used in conjunction with an MHL-enabled mobile device. For information on configuring MHL on your mobile device, refer to the device's User Manual.

-  If you connect a mobile device to the TV with an MHL-to-HDMI cable, the TV automatically switches the picture size of each content saved on the mobile device to the original picture size of that content.

Connect the MHL-to-HDMI cable to the HDMI (MHL) input connection of the TV and the mobile device's USB port as shown in the image below.

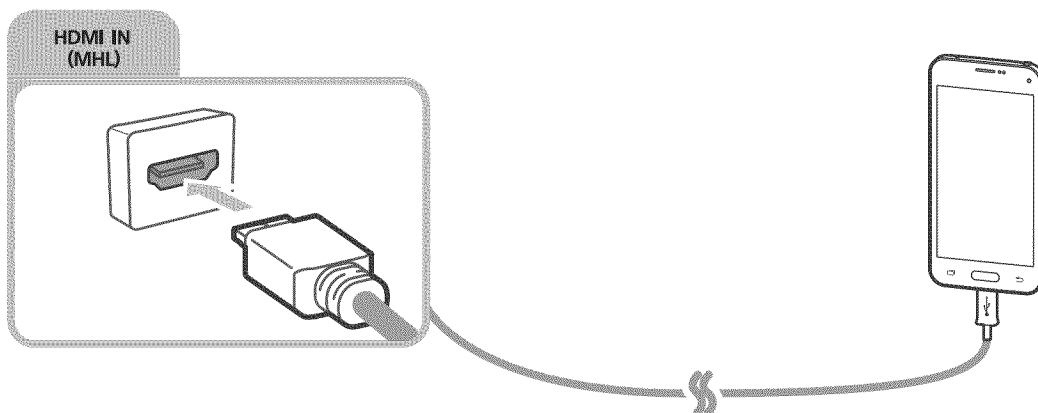

# Using Screen Mirroring

(MENU/123) > MENU > Network > Screen Mirroring **On/Now**

You can wirelessly connect a mirroring-enabled mobile device to the TV and play the video and audio files stored on the device on the TV. Mirroring refers to the function that plays the video and audio files located on a mobile device on a TV and on the mobile device simultaneously.

## Connecting via a mobile device

1. Launch the **Screen Mirroring** function on your mobile device. The mobile device searches for available devices to connect to.
2. Select the TV from the list, and then enter the password. The TV automatically allows the connection and the device connects.
3. Select **Allow** to connect the mobile device.

 All previously allowed mobile devices will automatically connect without needing approval.

 If you select **Deny**, the device cannot connect. To change the connection status of a denied device, Select **MENU > Network > Multimedia Device Manager**, select the device, and select **Allow**.

## Connecting by automatically allowing the connection

1. Select **Network > Screen Mirroring**. You can also start screen mirroring by pressing the **SOURCE** button on your remote and selecting **Screen Mirroring** from the list at the top of the screen.
2. Launch the **Screen Mirroring** function on your mobile device. The mobile device searches for available devices to connect to.
3. Select the TV from the list. The TV automatically allows the connection and the device connects.

 If the mobile device cannot connect, turn the TV and mobile device off and then on.

# Connecting mobile devices without a wireless router (Wi-Fi Direct)

(MENU/123) > MENU > Network > Wi-Fi Direct **Try Now**

You can connect a mobile device with the Wi-Fi Direct feature directly to the TV without using a wireless router or AP. By connecting a mobile device to the TV through **Wi-Fi Direct**, you can play photo, video, and music files saved on the mobile device on the TV.

1. Enable Wi-Fi Direct on the mobile device, and then run **Wi-Fi Direct** on the TV. The TV automatically scans for and displays a list of available devices. The TV's name also appears on the mobile device.
2. Select the device from the list to initiate a connection. If a connection request is made by the TV, a permission message appears on the mobile device and vice versa.
3. Allow the connection. The TV and mobile device connect.

 For more information, refer to "Playing multimedia content in a computer or mobile device."

 To confirm whether a mobile device allows or denies a connection, select **MENU > Network > Wi-Fi Direct > Device Manager**.

 To connect more easily, activate Wi-Fi Direct on your TV and mobile device, and then place the mobile device close to the TV. The connection permission confirmation window appears on the bottom left of the TV screen so that you can easily connect the device.

## Managing the connection status of previously connected mobile devices

1. Select **MENU > Network > Wi-Fi Direct > Device Manager**. The TV displays a list of devices that have previously connected to the TV or have tried to connect to the TV and been denied. The status of the connection (Allow/Deny) is also displayed.
2. Select a device.

## Select connection type or delete the device from the list.

 This function is only available if the devices have previously connected to the TV or have previously attempted to connect and been denied.



## Connecting a mobile device via Samsung Smart View 2.0

When you install and then launch Samsung Smart View 2.0 on a mobile device connected to the TV, you can play the mobile device's multimedia content, such as videos, photos, and music, on the TV. You can also send text messages or control the TV using the mobile device.

## Pairing a laptop to the TV (wireless PC mirroring)

You can view the enhanced or dual mode screen of a laptop on your TV by pairing the laptop to the TV wirelessly.

Connect a Wireless PC Mirroring Adapter (VG-SWD1000) to the laptop's HDMI port, and then connect the USB cable that came with the package between a USB port of the Wireless PC Mirroring Adapter (VG-SWD1000) and a USB port of the laptop. A pairing message appears on the TV's screen. If you allow the pairing, the laptop's screen is displayed on the TV's screen.

-  This function is not available on certain models in specific geographical areas.
-  This function is not available on third-party TVs or non-laptop devices.
-  If two Samsung TVs are located closely, turn off the TV to which you don't want to pair the laptop, and then try to pair.

# Switching between external devices connected to the TV

Press the **SOURCE** button to switch between external devices connected to the TV.

- **Options**

To view the options menu, press the down directional button. The functions that appear in the options menu can include any of the following:

 The connector names may vary depending on the product.

- **Edit Device Type:** Changes the type of external devices connected to the TV. Select an external device to change. For example, you can select **PC** for a PC connected to an HDMI connection and **Blu-ray** for a Blu-ray player connected to another HDMI connection. When you display the source list, the TV displays the name of each connection and the type of the device connected to each connection.
- **Edit Name:** You can rename devices connected to the TV to facilitate identifying external sources.
- **Information:** Displays information about the connected devices.
- **Anynet+ (HDMI-CEC):** Displays a list of Anynet+ (HDMI-CEC)-compliant devices that are connected to the TV.

 This option is only available when **Anynet+ (HDMI-CEC)** is set to **On**.



- **Remove USB Device:** Removes a USB device connected to the TV.
- **Remove Source Thumbnail:** Removes the captured images of the video that you viewed most recently that is saved on an external device connected to the TV.
- **Delete Universal Remote:** Deletes the external device connected to the TV via the Universal Remote function.

- **Universal Remote Setup**

You can use your TV remote control to control external devices.

 For more information on using the Universal Remote function, refer to "[Controlling External Devices with the TV Remote - Using the Universal Remote.](#)"

# Connection Notes

-  The number of connectors and their names and locations may vary depending on the model.
-  Refer to the external device's operating manual when connecting it to the TV. The number of external device connectors and their names and locations may vary depending on the manufacturer.

## Connection notes for HDMI

- Use an HDMI cable with a thickness of 0.55 inches (14 mm) or less.
  - Using a non-certified HDMI cable may result in a blank screen or a connection error.
  - Some HDMI cables and devices may not be compatible with the TV due to different HDMI specifications.
  - This TV does not support HDMI Ethernet Channel. Ethernet is a Local Area Network (LAN) built with coaxial cables standardized by the IEEE.
  - Use a cable shorter than 10 feet (3m) to get the best UHD viewing quality.
  - Many computer graphics adaptors do not have HDMI ports, but have DVI ports instead. If your computer graphics adaptor has a DVI port, use an HDMI-to-DVI cable to connect the computer to the TV.
-  For more information, refer to "[Connecting with an HDMI-to-DVI cable.](#)"
- If you are using an HDMI adapter to connect an MHL device, the TV recognizes the signal as an HDMI signal and may respond differently than it would to an MHL-to-HDMI cable connection.
  - Certain functions such as Smart Hub may not be available if the **Source** is set to HDMI and **3D Auto View** is set to **Auto1** or **Auto2**. If this is the case, set **3D Auto View** or **3D Mode** to **Off**.

## Connection notes for audio devices

- For better audio quality, it is a good idea to use an AV receiver.
- Connecting a device using an optical cable does not automatically turn off the TV speakers. To turn off the TV's speakers, set **Speaker Select** (MENU > Sound > Speaker Settings > Speaker Select) to something other than TV Speaker.
- An unusual noise coming from the audio device while you are using it may indicate a problem with the audio device itself. If this occurs, ask for assistance from the audio device's manufacturer.
- Digital audio is only available with 5.1-channel broadcasts.

## Connection notes for computers

- For the resolutions supported by the TV, refer to "Read Before Connecting a Computer (Supported Resolutions)."
- As long as file sharing is activated, unauthorized access may occur. When you do not need to access data, disable file sharing.
- Your PC and Smart TV must be connected to each other on the same network.

## Connection notes for mobile devices

- To use the Screen Mirroring function, the mobile device must support a mirroring function such as AllShare Cast or Screen Mirroring. To check whether your mobile device supports the mirroring function, please visit the mobile device manufacturer's website.
- To use Wi-Fi Direct, the mobile device must support the Wi-Fi Direct function. Please check if your mobile device supports Wi-Fi Direct.
- The mobile device and your Smart TV must be connected to each other in the same network.
- The video or audio may stop intermittently, depending on network conditions.





## Connection notes for wireless PC mirroring



- The working distance may differ due to obstacles (e.g., human bodies, metal objects, or walls) or electromagnetic environment. To ensure stable functioning, it is recommended to use the Wireless PC Mirroring Adapter (VG-SWD1000) in the same location where the TV is placed.
- When a Wireless PC Mirroring Adapter (VG-SWD1000) is connected, the TV may not play videos properly depending on whether there is another device that emits radio signals nearby.
- Do not place the Wireless PC Mirroring Adapter (VG-SWD1000) near any heat source, in a humid location, or under direct sunlight. This action may cause product malfunction or a fire.
- Do not apply any of the following to the Wireless PC Mirroring Adapter (VG-SWD1000): chemicals (e.g., wax, benzene, thinner, mosquito repellent, air freshener, lubricant) and cleaning agent that contains alcohol or solvent or that is surface active. This action may cause the dongle's exterior to discolor or its label to peel off.
- Do not disassemble, repair or modify the Wireless Mirroring Adapter (VG-SWD1000) by yourself. Stop using the dongle if it is damaged or broken.
- Make sure to use a genuine Wireless PC Mirroring Adapter (VG-SWD1000) supplied by Samsung Electronics.

# About the Samsung Smart Control

- ✎ The Samsung Smart Control is provided with the 6700 to 8500 and 670D to 850D series models. And it may not be provided with the 6700 series model in specific countries.



Button	Description
	Press this button to mute the sound temporarily. Press and hold this button to bring up the Accessibility Shortcuts menu that enables or disables the Accessibility menu functions (MENU > System > Accessibility).
MENU/123	Displays numeric buttons, the content control button, and other function buttons on the screen so that you can run a function conveniently. Press and hold this button to run the Voice Recognition function.  For more information, refer to "Displaying and using the On-Screen Remote."
POINTER	Place a finger on the POINTER button and move the Samsung Smart Control. The pointer on the screen moves in the direction you moved the Samsung Smart Control. Press the POINTER button to select or run a focused item.  For more information, refer to "Operating the TV with the POINTER button."
4 directional buttons	Moves the focus and changes the values seen on the TV's menu.
Enter button	Selects or runs a focused item. Press and hold this button to launch the Guide while you are watching the TV.
RETURN / EXIT	Returns to the previous menu or channel. Press and hold to exit the currently running function on the TV's screen.
	Launches Smart Hub applications.
	Controls the content when playing movies or music or viewing pictures.
EXTRA	Displays related information about the current program.
SOURCE	Displays and selects the available video sources.

-  Your Samsung Smart Control may differ from the images of the Samsung Smart Control in this e-Manual, depending on the model.
-  Use the Samsung Smart Control at a distance of less than 20 feet. The usable distance may differ with the wireless environmental condition.
-  The buttons and functions of the Samsung Smart Control may differ by model.

# Using the Samsung Smart Control



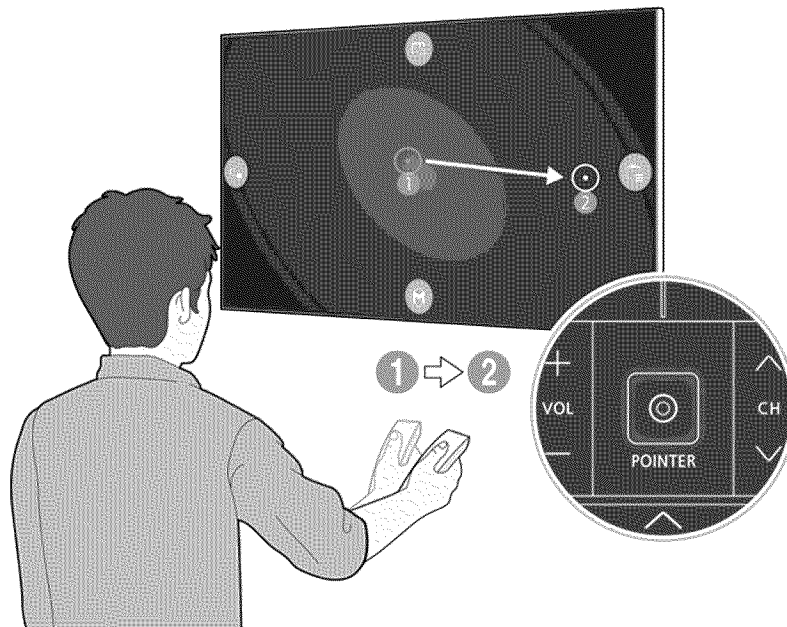

## Operating the TV with the POINTER button

Place a finger on the **POINTER** button and move the Samsung Smart Control. The pointer on the screen moves in the direction you moved the Samsung Smart Control. Move the pointer to select an item on the screen.



## Operating the TV with the directional buttons and the Enter button

Press the directional buttons (up, down, left, and right) to move the pointer, focus, or cursor in the direction you want or to change a setting shown on the focused item. Press the Enter button to select an item or run a focused item. Press and hold the Enter button to view the Guide while watching the TV.

-  To adjust the pointer speed, select **MENU > System > Smart Control Settings > Motion Sensitivity**.  **Now**
-  To use the **POINTER** button and the movement of the Samsung Smart Control to operate your TV, **Voice Guide** must be set to **Off**.
-  To view a tutorial that shows how to use the **POINTER** button, select **MENU > Support > Smart Control Tutorial**. **Try Now**

# Displaying and using the On-Screen Remote

You can display and use the On-Screen Remote on the TV's screen by pressing MENU/123 button on the Samsung Smart Control.

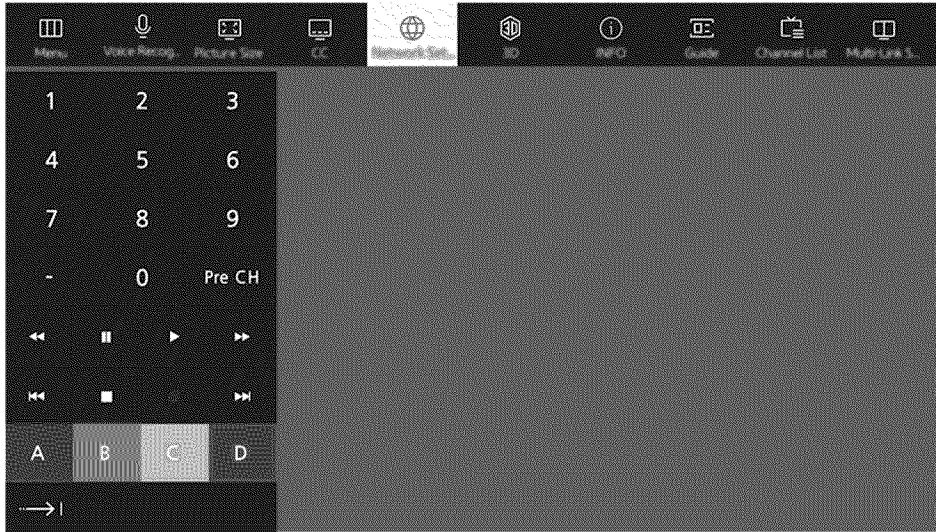

Button	Description
Menu	Displays the menu on the screen.
Voice Recognition	Runs the Voice Recognition function. ✎ For more information, refer to "Read Before Using Voice, Motion, or Face Recognition."
Picture Size	Changes the picture size.
Caption	Turns captions on or off.
Network Settings	Displays screens that allow you to change your network settings.
3D	Turns the 3D function on or off.
Info	Displays information about the current program or content.
Guide	Displays the Guide screen.
Channel List	Launches the Channel List.
Multi-Link Screen	Splits the TV screen and allows you to use multiple functions - such as watching TV, surfing the web, and playing a video - at the same time. ✎ For more information, refer to "Viewing Multiple Screens or Features with Multi-Link Screen".
Sports Mode or Soccer Mode	Enables/Disables Sports Mode. ✎ The actual name may differ with specific geographical area. ✎ For more information, refer to the "Making Sports Programs More Realistic with Sports Mode" section.
e-Manual	Opens the e-Manual.
Picture Mode	Changes the picture mode.
Speaker List	Allows you to select the speakers that will play the TV's audio.

Button	Description
MTS	Allows you to change the broadcast audio to stereo, mono, or SAP (Second Audio Program) for analog channels.
Sleep Timer	Shuts off the TV automatically after a preset period of time.
Tools	Displays the Tools menu on the screen.
Source	Displays the Source screen.
Power	Turns off the TV.
	Use these colored buttons to access additional options specific to the feature in use. ✎ These buttons are only available in the U.S.A. and Canada.
Move Number Pad to the Right / Move Number Pad to the Left	Moves the number pad to the left or right.

- ✎ This function is not available on certain models in specific geographical areas.
- ✎ The On-Screen Remote buttons may vary, depending on the TV model and the TV functions you are using.
- ✎ To change the order of the menu options on the first row, select a menu option to move, press and hold the Enter button, and then select the directional buttons displayed to specify a new position.

## Pairing the TV to the Samsung Smart Control

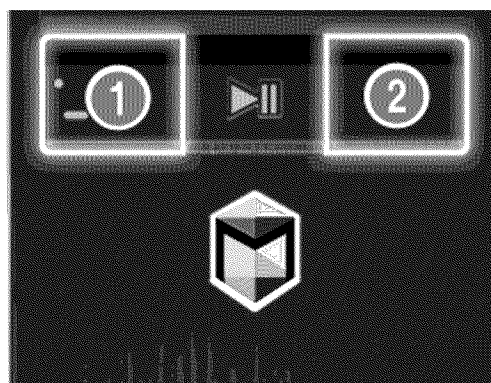

When you turn on the TV for the first time, the Samsung Smart Control pairs to the TV automatically. If the Samsung Smart Control does not pair to the TV automatically, point it at the remote control sensor of the TV, and then press and hold the buttons labeled ① and ② in the diagram on the left simultaneously for 3 seconds or more.





# Controlling External Devices with the TV Remote - Using the Universal Remote

(MENU/123) > MENU > System > Universal Remote Setup 

You can control external devices connected to the TV using the TV's remote control.

-  This function is not available on certain models in specific geographical areas.
-  You can also use the Anynet+ (HDMI-CEC) function to operate external Samsung devices with your TV's remote control without any additional setup. Refer to "[Using Anynet+ \(HDMI-CEC\)](#)" for more information.
-  Certain external devices connected to the TV may not support the universal remote feature.

## Setting up the universal remote control

1. Connect the external device to control with the universal remote control to an HDMI port on the TV, and then turn on the external device.
  2. Press the SOURCE button on your remote control to bring up the Source screen.
  3. Select **Universal Remote Setup** on the Source screen, and then follow the directions on the screen to complete the set up and register the device. The directions will be different, depending on the device you want to control.
-  If the external device does not respond after being registered, register it again using its model number.
  -  The TV memorizes both the external device and the connection (HDMI 1, HDMI 2, etc.) the device is connected to.

# Controlling the TV with a Keyboard

(MENU/123) > MENU > System > Device Manager > Keyboard Settings [Try Now](#)

 Certain models are not compatible with USB HID class keyboards.

## Connecting a keyboard

### Connecting a USB keyboard

Plug the keyboard cable into the TV's USB port.

### Connecting a Bluetooth keyboard





1. Place the Bluetooth keyboard into standby status.
2. Select MENU > System > Device Manager > Keyboard Settings > Add Bluetooth Keyboard. The TV automatically scans for available keyboards. [Try Now](#)

 If your keyboard was not detected, position the keyboard close to the TV, and then select **Refresh**. The TV scans for available keyboards again.

3. Select the Bluetooth keyboard from the scan list, and then select **Pair and connect**. A number appears on the screen.
4. Enter the number using the Bluetooth keyboard. This pairs the Bluetooth keyboard to the TV.

## Using the keyboard

You can use the following keys on a USB or Bluetooth keyboard connected to the TV to control the following remote features.

Keyboard	Remote control functions
Directional keys	Moves the focus
Windows key	Displays the menu
Menu list key	Displays the On-Screen Remote
Enter key	Selects or runs a focused item
ESC key	Returns to the previous screen
F1 / F2 / F3 / F4 key	 /  /  / 
F5 key	Launches the  button
F6 key	Displays the Source screen
F7 key	Launches the Channel List
F8 key	Mutes the sound
F9 / F10 key	Adjusts the volume
F11 / F12 key	Changes the channel

## Changing keyboard settings

(MENU/123) > MENU > System > Device Manager > Keyboard Settings > Keyboard Options 



- **Keyboard Language**

Displays the languages you can use on your keyboard and lets you select a language.

- **Keyboard Type**

Displays a list of keyboard types and lets you select a type that matches the Keyboard language you selected.



The list of keyboard types differs depending on the language you selected under **Keyboard Language**.

- **Switch Input Language**

Displays a list of keys you can use to toggle between languages and lets you select a key.

# Controlling the TV with a Mouse

(MENU/123) > MENU > System > Device Manager > Mouse Settings [Try Now](#)

 Certain models are not compatible with USB HID class mice.

## Connecting a mouse

### Connecting a USB mouse

Plug the mouse cable into the TV's USB port.

### Connecting a Bluetooth mouse

1. Place the Bluetooth mouse in standby status.
2. MENU > System > Device Manager > Mouse Settings > Add Bluetooth Mouse [Try Now](#)
3. Select the Bluetooth mouse from the scanned list, and then select **Pair and connect**. This pairs the Bluetooth mouse to the TV.

## Using a mouse

You can use a pointer to control the TV in the same way you use a pointer on a computer.

- **Selecting and running an item**

Left-click the mouse.

- **Scrolling the TV menu or screen**

Scroll the mouse wheel up or down.

- **Exiting the TV menu or feature**

Place the pointer in any blank point on the screen, and then left-click the mouse.

## Changing mouse buttons and pointer speed

(MENU/123) > MENU > System > Device Manager > Mouse Settings > Mouse Options [Try Now](#)

- **Primary Button**  
Select which button (left or right) to use when selecting and running items.
- **Pointer Speed**  
Adjust the movement speed of the pointer.

## Connecting a Bluetooth Gamepad

(MENU/123) > MENU > System > Device Manager > Bluetooth Gamepad Settings

You can play the games downloaded and installed using the Smart Hub service with a Bluetooth gamepad. Select **Bluetooth Gamepad Settings**, and then place your Bluetooth gamepad close to your TV. The TV scans for available Bluetooth gamepads automatically. (DualShock®4, a gamepad optimized for PlayStation, is recommended.) After scanning, you can use the Bluetooth gamepad to play games.

 If the TV fails to find your Bluetooth gamepad, place it closer to the TV, and then select **Refresh**. For more information on pairing, refer to the Bluetooth gamepad's operating manual.

## Entering Text using the On-Screen QWERTY Keyboard

### Using additional functions

Select  on the QWERTY keyboard screen. The following options are available:

- **Recommended text**  
Enables or disables the recommended text feature. The keyboard displays recommended words so that you can enter the text more easily.
- **Reset recommended text data**  
Deletes both the recommended words and the memorized words to clear the list.
- **Predict Next Character (when using direction buttons)**  
Enables or disables the Text Prediction feature.
- **Language**  
Select a language from the list.

# Viewing Multiple Screens or Features with Multi-Link Screen

(MENU/123) > MENU > Picture > Open Multi-Link Screen

You can search the Web, use apps, and much more simultaneously while watching TV.

## Using Multi-Link Screen

### Learning the basic functions

- **Changing the channels on and volume of a Multi-Link Screen**

To change the channels on a Multi-Link Screen, press the channel buttons while you are watching the TV. To adjust the volume of a Multi-Link Screen, move to the screen you want to adjust the volume on, and then press the volume buttons.

- **Changing the input signal**

Press the **SOURCE** button while using Multi-Link Screen to display the source list. Select a signal source from the list. You view the screen of the external device while you are watching the TV.

- **Changing the web browser and apps**

While you are using **Multi-Link Screen**, recently viewed web browser pages or apps are displayed on the right side of the screen. You can change these pages or apps to other pages and apps as you use the web browser or apps in **Smart Hub**.

- **Changing the size of a Multi-Link Screen**

To change the size of a Multi-Link Screen, move the focus to the screen you want to resize, and then use the up or down directional button. Alternatively, drag the line in the middle of the screen to the left or right. To display the focused Multi-Link Screen in full screen mode, select



- **Selecting a speaker device for a Multi-Link Screen**

Press the volume button, and then press the left directional button. The speaker list is displayed on the screen. Select **Custom** to turn on or off the sound from the selected screen. If you connect a Bluetooth headphone, you can only select **Bluetooth Headphones**.



On the Samsung Smart Control, press the **MENU/123** button, and then select **Speaker List** to set the speaker of each screen.

## Read before using Multi-Link Screen

- Before using Multi-Link Screen, make sure the TV is connected to the Internet.
- Before using Smart Hub with Multi-Link Screen, make sure to finish configuring Smart Hub.
- UHD content and channels cannot be viewed simultaneously.
- Certain TV features and apps may not be supported by Multi-Link Screen. If this is the case, exit from Multi-Link Screen, and then use the feature.
- You can hear the selected audio while you are using the Multi-Link Screen through the TV's speakers and you can hear the other screen's audio through Bluetooth headphones.

## Smart Hub

or (MENU/123) > MENU > Smart Hub > Open Smart Hub [Try Now](#)

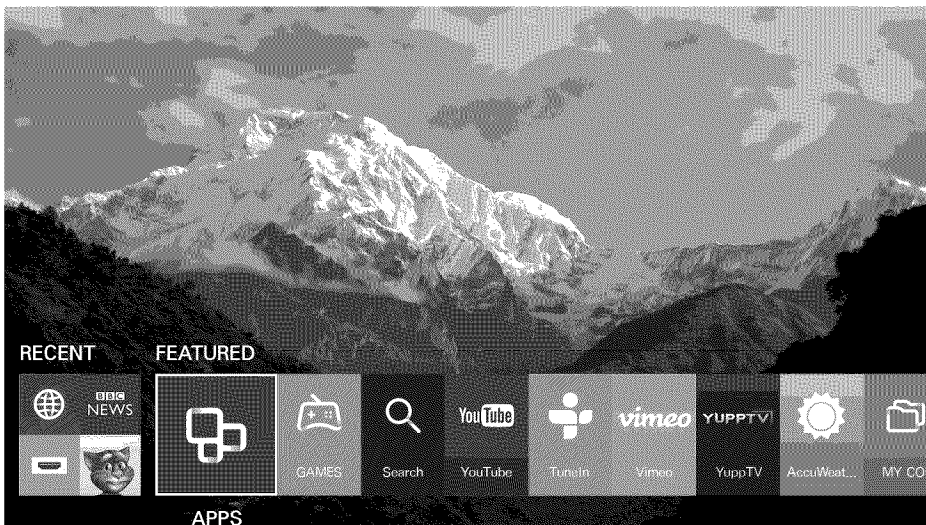

- The image may differ with the specific model and area.

You can surf the web and download apps with Smart Hub. In addition, you can enjoy photo, video, and music files stored on external storage devices.





Place a finger on the **POINTER** button to display the pointer on the screen. Select  at the bottom of the screen to launch Smart Hub.

- To run **Smart Hub** while you are using a service provided by Smart Hub, use the same path described above.

## Removing or pinning an item in the Recent group

To remove or pin an item in the Recent group, select  that appears above the item. The following icons are available.

 On the standard remote control, press the  button.

- : Deletes the item. Although you remove an item from the Recent group, it is not removed from your TV.
- : Pin the item to the first position. To unpin the item, select  again.
- : Runs the item in a multiple screen with the Multi-Link Screen function. ((MENU/123) > MENU > Picture > Open Multi-Link Screen)

 This icon may not be displayed depending on the item.

## Launching Smart Hub automatically

(MENU/123) > MENU > Smart Hub > Auto-Start Settings > Smart Hub

You can start Smart Hub automatically when you turn on the TV.

## Testing Smart Hub connections

(MENU/123) > MENU > Support > Self Diagnosis > Smart Hub Connection Test

If Smart Hub is not working, select Smart Hub Connection Test. The Connection Test diagnoses the problem by checking the Internet connection, your ISP, the Samsung server, and the Apps service.

## Using the Smart Hub tutorial







(MENU/123) > MENU > Support > Smart Hub Tutorial

You can learn the basics of using Smart Hub and the Smart Hub service in detail.

## Resetting Smart Hub

(MENU/123) > MENU > Smart Hub > Reset Smart Hub [Try Now](#)

You can remove the Samsung accounts saved in the TV and everything linked to them, including apps.

-  Some of the Smart Hub services are for paid services. To use a for paid service, you must have an account with the service provider or a Samsung account. For more information, refer to "Using Smart Hub with a Samsung Account."
-  To use Smart Hub, the TV must be connected to the Internet.
-  Some Smart Hub features may not be available depending on the service provider, language, or region.
-  Smart Hub service outages can be caused by disruptions in your Internet service.
-  To use Smart Hub, you must agree to the end user agreement and privacy policy. Otherwise, you will not be able to access the features and services associated with them. You can view the entire text of the **Terms & Policy** document by navigating to **Smart Hub > Terms & Policy**. If you want to stop using Smart Hub, you can cancel the agreement. [Try Now](#)
-  To view the **Smart Hub Tutorial**, select the  button on the **Recent** screen.



# Using Smart Hub with a Samsung Account

## Creating a Samsung account

(MENU/123) > MENU > Smart Hub > Samsung Account

Some of the Smart Hub services are for paid services. To use a for paid service, you must have an account with the service provider or a Samsung account.



You can create a Samsung account using your email address as your ID.

-  To create a Samsung account, you must agree to the Samsung account end user agreement and privacy policy. To view the entire content of the agreement, select **MENU > Smart Hub > Samsung Account > Terms and Conditions, Privacy Policy**.
-  You can also create a Samsung account at <http://content.samsung.com>. Once you have an account, you can use the same ID on both the TV and the Samsung website.

## Creating a Samsung account

(MENU/123) > MENU > Smart Hub > Samsung Account > Create Account > Create Samsung Account

You can create a Samsung account by following the on-screen instructions. Once a Samsung account is created, you are automatically signed in to your Samsung account.

-  If you want to review the Terms and Conditions, select **View Details**.
-  If you want your account to be protected, select **Profile image selection and password entry (High security)** in the field below the password field.
-  If you want the TV to log you in to your account automatically when you turn the TV on, click **Sign me in automatically**.

## Creating a Samsung account using a Facebook account

(MENU/123) > MENU > Smart Hub > Samsung Account > Create Samsung Account with Facebook

Enter your Facebook ID and password, and then follow the on-screen instructions to complete account setup. Once a Samsung account is created, you are automatically signed in to your Samsung account.

-  Your Samsung account and Facebook account are automatically linked when you create a Samsung account with your Facebook account.

## Signing in to a Samsung account

(MENU/123) > MENU > Smart Hub > Samsung Account > Sign In

You can automatically sign in to your Samsung account and use the Smart Hub feature.

### Registering an existing Samsung account to the TV

If you already have a Samsung account, you can register that account to the TV. Select + > Sign In on the Samsung account screen, and then follow the on-screen instructions.

### Signing in to a registered Samsung account saved on the TV

If you register a Samsung account, it is saved on the TV. To sign in to a registered Samsung account, just select it on the TV.

 To change the sign in method, refer to "[Changing and adding information to a Samsung account.](#)"

## Linking your Samsung account to external service accounts

You can automatically log in to external service accounts when you log into your Samsung account by linking your Samsung account to the external service accounts.

 To use **Link Service Accounts**, you must first log into your Samsung account.

### Linking or disconnecting a service account

(MENU/123) > MENU > Smart Hub > Samsung Account > Link Service Accounts

- **Linking a service account**

Select an account from the list and log in to the account by following the on-screen instructions. The service account is linked to the Samsung account.

- **Disconnecting a linked account**

Select an account from the list and unlink the account by following the on-screen instructions.

## Changing and adding information to a Samsung account

(MENU/123) > MENU > Smart Hub > Samsung Account > Edit Profile

You can manage your Samsung account. Enter your password with the keyboard displayed on the TV's screen, and then select **Done**. You can perform the following functions on the screen.

 To change the account information, you must be logged in to your Samsung account.

- **Change Your Profile Image**
- **Register Your Face to your Samsung Account**  
Registered faces are used with the Login Options.
- **Select a Samsung Account sign-in method**
- **Turn auto login on or off**
- **Enter Basic User Information**
- **Subscribe to the Samsung e-Newsletter**

## Deleting a Samsung account from the TV

(MENU/123) > MENU > Smart Hub > Samsung Account > Remove Accounts from TV

You can remove a Samsung account and password information from your TV. The account information for any external accounts linked to the account is also removed from the TV.



 To remove the account information, you must be logged in to your Samsung account.

# Using the GAMES Service

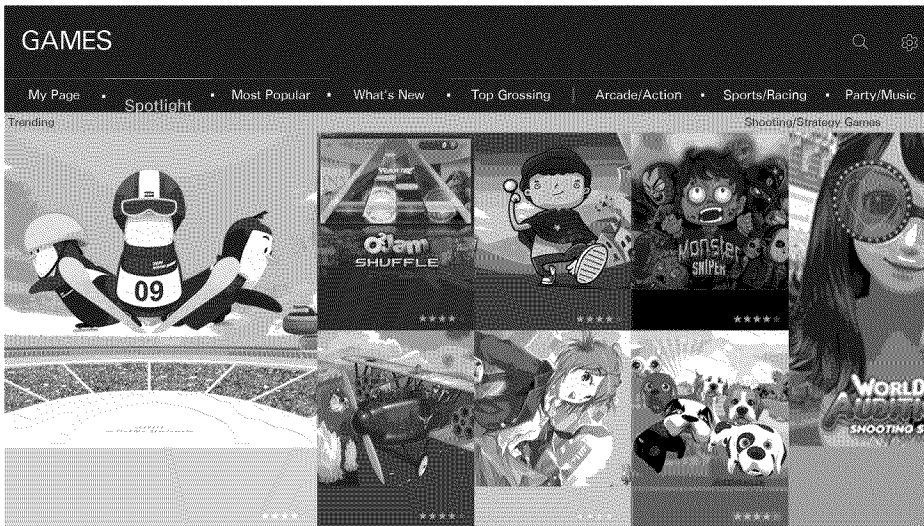
 > **Featured** > **GAMES**



You can download, play, and manage games or games purchased with your Samsung account. Select a game displayed on the screen or select a genre category such as **Spotlight**, **Most Popular**, **What's New**, or **Top Grossing** from the top of the screen, and then select a game in the genre you selected. You can also manage downloaded games in **My Page**.

-  This function is only available in the U.S.A. and Canada.
-  To use this feature, the TV must be connected to the Internet.
-  The genre categories at the top of the screen may differ with the model and geographical area.

## Managing games with the pop-up Options menu

Move the focus to a game, and then press and hold the Enter button. An option menu appears displaying some or all of the following options.

- **Download / Remove**
- **View Details**
- **Update**

-  The pop-up menu may differ with the app you selected.





## Viewing the Detailed Information screen

Move the focus to a game, and then press the Enter button. You can also select the View Details function. See above.

# Installing and running a game

## Installing games

Select a game to install, and then press and hold the Enter button. Select **Download** in the context-sensitive window or install the game from the detailed game information screen.

-  To get the information about the game controllers that are compatible with the downloaded game, select **GAMES > Options > Game Controller Guide**. Alternatively, select  on the game's detailed information screen.
-  When the TV's internal memory is insufficient, you can install a game on a USB device.
-  You can play a game installed on a USB device only when the USB device is connected to the TV. If the USB device is disconnected during game playing, the game is terminated.
-  You cannot play a game installed on a USB device on a PC or another TV.

## Launching an installed game

To run a game, you need to sign in to your Samsung account first. After signing in, select a game on **GAMES > My Page** on the **GAMES** screen. The detailed information screen about the selected game appears. Select **Play**. The game starts.

## Managing downloaded or purchased games

Select **My Page** on the **GAMES** service screen.

## Updating a game

Select **My Page > Options > Update My Games**. You can update games installed on the TV.

## Enabling automatic game updates

(MENU/123) > MENU > Smart Hub > App & Game Auto Update or App Auto Update

To update games automatically, set **App Auto Update** to **On**. Games will be updated automatically when an update becomes available.

 The actual name may differ with specific geographical area.

## Removing a game

1. Select  on the **My Page** screen, and then select **Delete My Games**.
2. Select a game to remove, and then press the **Enter** button. Repeat the process to select additional games to remove. To select all games, select **Select All**.

 You can remove a game by selecting the game, and then pressing and holding the **Enter** button.

3. When you are done selecting games, select **Delete**.

## Rating a game

You can rate a game on the detailed information screen.

 This feature is only available when the game is installed on your TV.

## Registering a coupon



Enter the coupon number on the **My Page** screen to register it.

# Using the APPS Service

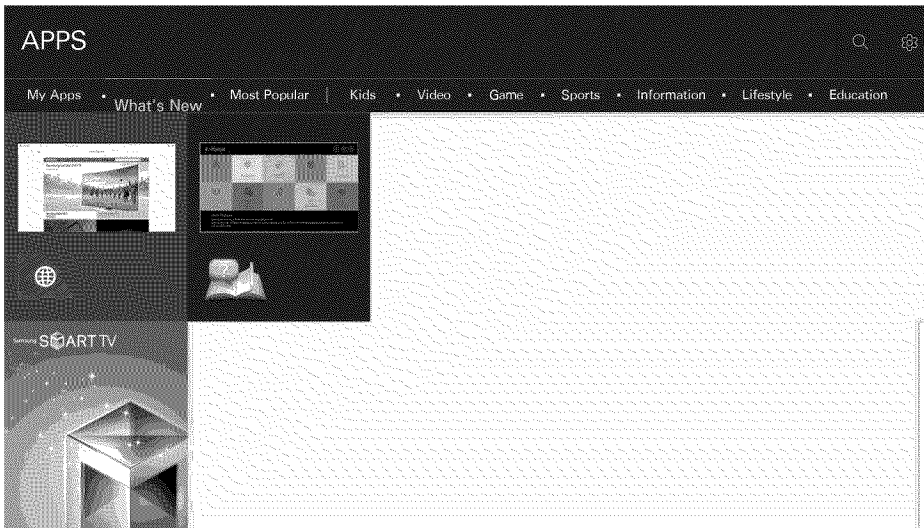
 > **Featured** > APPS



You can enjoy a wide range of content including news, sports, weather and games by installing the corresponding apps on your TV. You can download the apps from Smart Hub. Select an app displayed on the screen or select a genre category such as **Most Popular**, **What's New** from the top of the screen, and then select an app in the genre you selected. You can also manage downloaded apps in **My Apps**.

-  To use this feature, the TV must be connected to the Internet.
-  When Smart Hub is launched for the first time, the default apps are automatically installed. The default apps may differ by region.

## Managing Apps with the pop-up Options menu

Move the focus to an app and then press and hold the Enter button. The option menu appears displaying some or all of the following functions.

- **Delete**
- **View Details**
- **Reinstall**

-  The pop-up menu may differ with the app you selected.





## Viewing the Detailed Information screen

Move the focus to an App, and then press the Enter button. You can also select the View Details function. See above.

# Installing an app



## Quickly installing apps

1. Select a category on the **APPS** screen.
2. Move the focus to an app, and then press and hold the Enter button. The context-sensitive menu appears.
3. Select **Download**. The selected app is installed on the TV.

-  You can view installed apps on the **My Apps** screen.
-  You can also install an app from its detailed information screen.
-  When the TV's internal memory is insufficient, you can install an app on a USB device.
-  You can run an app installed on a USB device only when the USB device is connected to the TV. If the USB device is disconnected while an app is running, the app is terminated.
-  You cannot run an app installed on the USB device on a PC or another TV.

## Launching an app

You can launch an app by selecting the app on the **APPS** screen. The icons below appear within the selected app's icon and indicate the following:

-  : The app is installed on a USB device.
-  : The app has a password.
-  : The app is installed.

## Enabling automatic apps updates

(MENU/123) > MENU > Smart Hub > App & Game Auto Update or App Auto Update

To update apps automatically, set **App Auto Update** to **On**. Apps will be updated automatically when an update becomes available.

-  The actual name may differ with specific geographical area.

## Removing an app from the TV

Select an app to remove on the **APPS** screen and press and hold the **Enter** button to confirm. If you want to remove multiple apps, select all the apps to delete, select **Options** on the top of the screen, and then select **Delete My Apps**.

 Ensure that the related app data is also removed when you remove an app.

## Locking and unlocking apps

Select **Options > Lock/Unlock My Apps** on the **APPS** screen. The password input screen appears. Enter your password, and then select apps to lock or unlock. When done selecting, select **Save**. All selected apps are locked or unlocked.

## Updating apps

Select **Options > Update Apps** on the top of the **APPS** screen. The TV searches for app updates, and then displays a list. You can update some apps or all apps.

## Rearranging apps

Select **Options > Sort by** on the **APPS** screen, and then sort the apps by date, time or others by selecting requirements.

## Rating purchased apps

You can set the star score by using the left or right directional buttons on the detailed information screen.

## Using other app features and functions

(MENU/123) > MENU > Smart Hub > Auto-Start Settings > Channel-bound Apps & Ticker

You can configure additional app features and functions.

### Using channel bound apps

A channel bound app provides information about offerings and services available on one channel. You can receive information about TV programs and other relevant services while watching TV by using a channel bound app that is installed on the TV and linked to a specific channel.

 This function is only available when an app supporting **Channel-bound Apps & Ticker** is installed on the TV.

# Using the e-Manual

## Launching the e-Manual

(MENU/123) > MENU > Support > e-Manual

You can view the embedded e-manual that contains information about your TV's key features. Press the MENU/123 button, and then select e-Manual.

1. Select a category from the e-Manual screen. The content of the selected category appears on the screen.
2. Select an item from the list. The corresponding e-Manual topic appears.

 On the standard remote control, press the E-MANUAL button.

 Alternatively, you can download a copy of the e-Manual from Samsung's website.

 Words in blue (e.g., **Picture Mode**) indicate a menu item.

The arrows in the menu navigator indicate the menu path. For example, MENU/123 > MENU > Picture > Picture Mode means that you press the MENU/123 button on the Samsung Smart Control, and then select the on-screen display items, Menu, Picture, and Picture Mode sequentially.

## Using the buttons in the e-Manual

 (Search): Brings up the search screen. Enter a search term, and then select Done. Select an item from the search result to load the corresponding page.

 (Index): Brings up the index screen. Select a topic from the list to navigate to the relevant page.

 (Recently Viewed Topics): Displays a list of previously read pages. Select a page. The e-Manual jumps to the selected page.

## Accessing the associated menu screen from an e-Manual topic page

 (Try Now): Allows you to access the corresponding menu item and try out the feature right away.

 (Link): Allows you to access the corresponding reference page.

 The e-Manual cannot be accessed from some menu screens.

## Accessing the associated menu screen from an e-Manual topic page

Press the MENU/123 button on the Samsung Smart Control, then select e-Manual on the On-Screen Remote to read the e-Manual topic about a current screen menu function.

 On the standard remote control, press the E-MANUAL button.



 The e-Manual cannot be accessed from some menu screens.

## Updating the e-Manual to the latest version

You can update the e-Manual in the same way you update apps.

# Using the Web Browser

You can surf the Internet on the TV as you would on a PC – even while watching a TV program using PIP. Select **Help** to view the information about the Internet web browser.

-  For a more convenient web browsing experience, connect a keyboard and mouse to the TV.
-  You can scroll the Web browser page with the 4 directional buttons.
-  The Web browser page may differ from that on a PC.

## Browsing preferences

Configure the browsing settings for your convenience or to meet your needs. Select **≡ > Settings**.

- **General**

Hides browser tabs or menu bars automatically after a period of inactivity. Also allows you to reset all user settings.

 Your bookmarks and browsing histories will not be reset.

- **Home Page**

Sets the home page. When you launch the browser, it will display this page.

- **Search Engine**

Searches for information that you requested, and then displays a list of web pages that contain the information.

- **Privacy & Security**

Prevents access to inappropriate web pages. Also allows you to select not to save your browsing history.

- **Blocked pages**

Blocks or unblocks pages. You can manage the list of pages you blocked.

- **Approved pages**

Limits the browser to only the pages you have approved. To use this option, you must set a password. You can add or remove approved pages.

- **Encoding**

Gives you the option to set the encoding to **Auto** or select an encoding method from a list.

- **About**

Displays the current version of Web Browser.

# Using the MY CONTENT Service

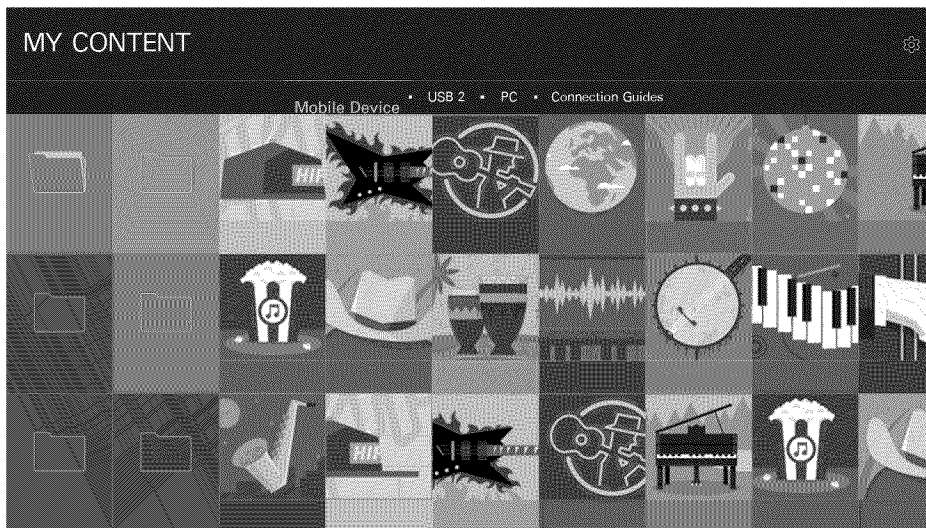

> Featured > MY CONTENT [Try Now](#)



You can play media content saved on storage devices, such as USB devices, mobile devices, and cameras, on the TV. When you connect a storage device to the TV, the TV displays a tab with the name of the connected device. Select the tab to confirm the content saved on the storage device.

-  You cannot play media content if the content or the storage device is not supported by the TV. For more information, refer to "Read Before Playing Photo, Video, or Music Files."
-  Backup important files before connecting a USB device. Samsung is not responsible for damaged or lost files.

## Read before playing media content

-  To connect the TV to a computer, refer to "Connecting a Computer."
-  To connect a USB or external storage device to the TV, use the TV's USB port.
-  To connect the TV to a mobile device, refer to "Connecting a Mobile Device."

## Playing multimedia content in a computer or mobile device

 Before connecting to a computer or mobile device, configure the network settings.

### Playing multimedia content saved on a computer or mobile device

 > **Featured** > **MY CONTENT**

To play multimedia content located on a computer or mobile device on the TV, you must allow the connection with the computer or mobile device on the TV.

1. Connect a computer or mobile device. The TV displays the device's name and lists the media files in the device.
2. Select a media file to play from the list. The selected media plays.
3. Select the  button to stop playing or press the RETURN button.

 Alternatively, move to the media content you want to play, and then press the  button to play the content.

 To connect a computer through your home network, refer to "Connecting a Computer."

 The TV may not play content located on a computer or mobile device depending on the encoding type and file format of the content.

 To connect a mobile device through Smart View 2.0, refer to "Connecting a Mobile Device."

 Content may not play smoothly depending on the network status. If this occurs, transfer the content to a USB storage device, and then play the content from the device.

## Playing media content saved on a USB device

1. Select a USB device name on the MY CONTENT screen. The TV displays a thumbnail list of the media content saved on the USB device.
2. Select the media content to play from the list. The media content plays.
3. Select the  button to stop playing or press the RETURN button.

 While video with UHD-level resolution is being played, **Motion Control** is not available.

 Alternatively, if you select a USB device on the **Source** screen, the TV jumps to the **MY CONTENT** screen automatically.

### Safely Removing a USB Device

1. Press the SOURCE button. The Source screen appears.
2. Move the focus to the USB device you want to remove, and then press the down directional button.
3. Select **Remove USB Device** in the list.

## Buttons and functions available while viewing photos

You can press the Enter button while viewing photos to display available options. You can also view the thumbnails of photos saved on the TV while viewing photos. The options disappear when you press the RETURN button.



- **Pause / Play**

Start or stop a slideshow. Using slideshow, you can display all the photos in a folder one after another, automatically.

- **Previous / Next**

View the previous or the next photo.

- **Options**

Function	Description
Slideshow Speed	Sets the slideshow speed.
Slideshow Effect	Applies transition effects to the slide show.
Zoom & Rotate	Zooms in by up to a factor of 4. Rotates the photo.
Background Music	Plays background music while the TV displays photos.  The music files must be saved in the same USB device as the photo files.  When background music plays, the music icon appears on the screen. Using the music icon, you can pause the current music file or play another music file.
Sound Mode	Displays a list of sound modes and lets you change the mode.  This function is available only when background music is playing.
Speaker List	Gives you a choice of which speakers to play the background music through. TV Speaker: Plays the background music through the TV speakers. Audio Out: Plays the background music through the external speakers. Speaker Settings: Plays the background music through a speaker that you want. Sound Mode: Changes the sound mode during playback when you play the music through the TV speakers.
Picture Mode	Displays a list of Picture Modes and allows you to change the mode.
Information	Displays detailed information about the current photo.

## Buttons and functions available while viewing videos

You can press the Enter button while viewing videos to display available options. Preview images of video frames with their time intervals displayed simultaneously so that you can move to a specific frame easily. The options disappear when you press the RETURN button.

- **Pause / Play**

Pauses or plays the video. You can use the following functions when the video is paused.

 With the video paused, the TV does not play audio.

- **Step:** Allows you to step through the paused video one frame at a time by pressing the **III** button.
- **Slow Motion:** Allows you to play the video in slow playback speed (1/8, 1/4, 1/2) by pressing the **▶▶** button.

- **Rewind / Fast Forward**

Rewinds or fast forwards the video. To increase the rewind or fast forward speed up to 3 times faster than normal, select the button repeatedly. To restore normal playback speed, press the **▶** button.

- **Previous / Next**

Plays the previous or next video. Press the **I◀◀** button twice to play the previous video. Press the **I◀◀** button once to start the current video from the beginning.

Press the **▶▶I** button to play the next video.

- **Repeat**

Plays the current video file repeatedly or all video files in the same folder repeatedly.

- Options

Function	Description
Picture Size	Changes the size of the screen. The supported picture sizes differ with the video.
Subtitles	<p>Controls video subtitles.</p> <p>Subtitles: Turns the subtitles on or off.</p> <p>Language: Sets the caption language.</p> <p>Sync: Adjusts the synchronization when the video and the subtitles are not synchronized.</p> <p>Reset Sync: Resets the subtitle synchronization adjustment to 0.</p> <p>Size: Changes the font size of the subtitles.</p> <p>Encoding: Displays a list of encoding languages. Allows you to change the encoding language when subtitles are displayed incorrectly.</p>
Rotate	Rotates the video.
Picture Mode	Displays a list of Picture Modes and allows you to change the mode.
Sound Mode	Displays a list of Sound Modes and allows you to change the mode.
Speaker List	<p>TV Speaker: Plays the video sound through the TV speakers.</p> <p>Audio Out: Plays the video sound through the external speakers.</p> <p>Speaker Settings: Plays the TV sound through a speaker that you want.</p> <p>Sound Mode: Changes the video sound mode during playback when you play the video sound through the TV speakers.</p>
Audio Language	Displays a list of languages and allows you to select the audio language that will be used when you play videos. This function is only available if the video supports multi-track sound.
Information	Displays detailed information about the video.

## Buttons and functions available while playing music

You can use the following functions when you select a music file.

- **Pause / Play**

Pauses or resumes the music.

- **Previous / Next**

Plays the previous or next music file. Press the ⏮ button twice to play the previous music file. Press the ⏮ button once to start the current music file from the beginning.

Press the ⏭ button to play the next music file.

- **Repeat**

Plays the current music file repeatedly or all music files in the same folder repeatedly.

- **Shuffle**

Plays the music files in random order.

- **Speaker List**







- **TV Speaker:** Plays the music through the TV speakers.
- **Audio Out:** Plays the music through the external speakers.
- **Speaker Settings:** Plays the music through a speaker that you want.
- **Sound Mode:** Changes the sound mode during playback when you play the music through the TV speakers. (MENU > Sound > Sound Mode)

- **Screen Off**

Plays the music files only with the screen off.

## Listening to music in HD quality

You can enjoy HD music in HD native quality. Set **HD Audio** (MENU > Sound > Additional Settings > HD Audio) to **On**. Then, move to the **MY CONTENT** service screen, and select an HD music file to play in HD quality.

-  Standard audio signals are sampled at 48 kHz while HD audio signals are sampled at 96 kHz.
-  Some S/PDIF receivers may not be compatible. For incompatible receivers, deactivate **HD Audio** and use normal audio mode instead.
-  Some external audio players connected via HDMI, Bluetooth, or Wi-Fi networks are not able to play HD audio signals.
-  If a music file supports the HD audio format, the HD icon appears in the list.
-  Select a music file, and then select ► to play it.
-  When you set **HD Audio** to **Off** during playback, the next music file is played in the standard audio format.
-  When you play an HD music file while **Multi-Link Screen** is running, **Multi-Link Screen** is automatically terminated.

## Functions on the media content list screen

You can use the following functions on the media content list screen of a storage device.

- **Filter By**

Filters the media content to display the type of media you want.

- **Sort By**

Sorts the content list. The sorting methods change depending on the type of content you have selected.

 This function is not available when **Filter By** is set to **All**.

- **Delete**

Deletes the recorded media content from the media content list.

 This function is not available in the U.S.A. and Canada.

 This function is only available when the storage device has the recorded media content.

- **Play Selected**

Plays the selected media content from the media content list.

 This function is not available when **Filter By** is set to **All**.

# Using the NewsON Service

📺 > Featured > NewsON

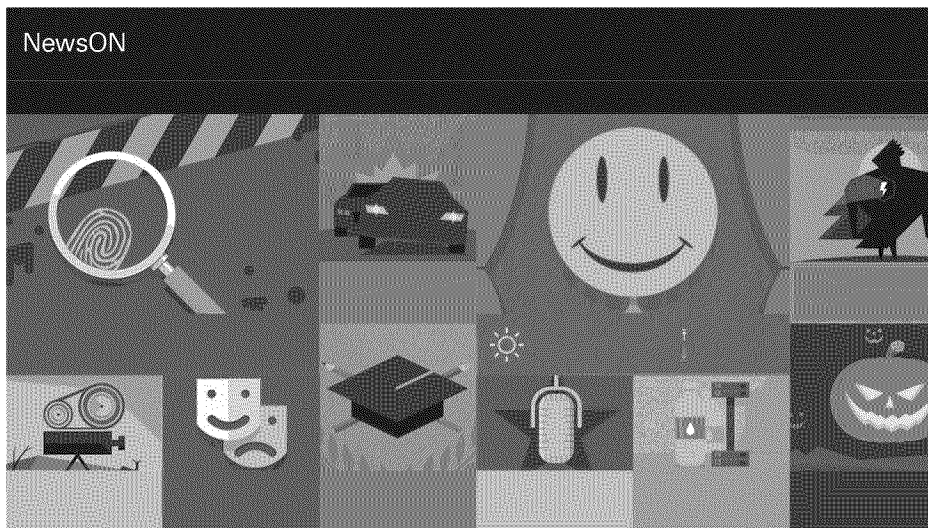

You can find daily information on a wide variety of topics in a smart and convenient way, updated in real time. NewsON brings you the latest headlines, top stories, popular issues, and weather forecasts.

- ✎ This function is not available in the U.S.A. and Canada.
- ✎ Before you use the NewsON service, check if the TV is connected to the Internet.

## Using the NewsON content

- **Watching news videos**

You can watch the latest news videos and related news videos.

- **Reading articles**

You can read news articles on the screen.

- **Viewing the weather information**

You can view the current weather forecast and forecasts for the next 7 days for cities you select.

- ✎ You can select up to 5 cities.

# Using the Soccer Service

## > Featured > Soccer

You can get a wide range of information about world soccer matches, including videos, news, matchups, and ratings. You can also easily access information about your favorite team by adding it to the Favorite list.

 This function is not available in the U.S.A. and Canada.

 Before you use the Soccer service, check if the TV is connected to the Internet.

## Configuring the Soccer service screen to display your favorite soccer teams

You can configure the Soccer service screen to display only your favorite soccer teams. To add a team to the favorite soccer team list located at the top of the screen, select + next to the list, and then select a team. After adding teams, if you select a team in the favorite soccer team list, its ranking in the league, game results, game videos, and schedules are displayed in the content area of the Soccer service screen.

 You can add up to 6 teams to the favorite soccer team list.

## Using additional functions

Select  at the top of the Soccer service screen. The following functions are available:

- **Add Teams**

Displays the league selection screen to allow you to add teams to the favorite soccer team list.

- **Move Teams**

Allows you to rearrange the order of the selected teams.

- **Remove Teams**

Removes teams you select from the favorite soccer team list.

- **Replace Teams**

Allows you to change your favorite team to another. Select an existing team, and then select a new team on the league selection screen. The existing team is replaced with the new team. The new team's name is displayed at the top of the screen.

## Viewing soccer videos

You can view the soccer videos and highlights of your favorite soccer teams. On the **Soccer** service screen, select a team, and then select a video you want to watch.

### Buttons and functions available while watching a soccer video

- **Play / Pause**  
Pauses or plays the video.
- **Previous / Next**  
Plays the previous or next video.
- **Rewind / Fast Forward**  
Rewinds or fast forwards the video.
- **Repeat**  
Plays the video repeatedly.
- **Options**



Function	Description
Picture Size	Changes the size of the screen.
Picture Mode	Allows you to change the picture mode of the current video.
Speaker List	TV Speaker: Plays the video sound through the TV speakers. Audio Out: Plays the video sound through the external speakers. Speaker Settings: Plays the sound from the TV through a speaker that you select.
Sound Mode	Changes the sound mode of the current video when you play the video through the TV speaker.

# Controlling the TV with Your Voice

 This function is only supported for the 6700 to 8500 and 670D to 850D series models.

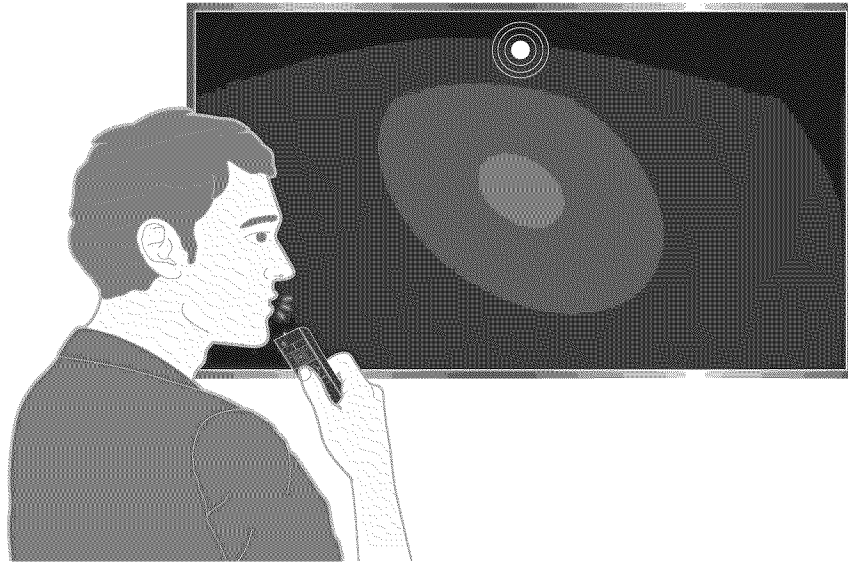
MENU/123 > Voice Recognition



-  The Voice Recognition screen may differ from the image above, depending on the model.
-  The Samsung Smart Control may not be provided with specific model and country.
-  When you run Voice Recognition, the Voice Recognition User Guide appears at the top of the screen. This Guide is different for each language supported by Voice Recognition.

You can run Voice Recognition in two modes:

- The short distance recognition mode that uses the microphone built into the Samsung Smart control:
  - Press the MENU/123 button, and then select **Voice Recognition**.
  - Or, press and hold the MENU/123 button.

## Read before using voice recognition

(MENU/123) > MENU > System > Voice Recognition

You can access and select certain menu options and functions using voice commands. For more effective voice recognition, speak slowly and clearly in the language specified in the MENU > System > Voice Recognition Language option.

 For more information about voice recognition, refer to "Read Before Using Voice, Motion, or Face Recognition."

## Learning voice recognition basics

- **View all voice commands:**

Press the down directional button on Samsung Smart Control to display a complete list of voice commands by category. Alternatively, say "Help."

- **Deactivating voice recognition:**

Say "Close", or press the RETURN button to terminate voice recognition.

 The TV recognizes predefined voice commands only. These voice commands may differ from the manual depending on the version of the TV.

## Enabling or disabling TV voice

(MENU/123) > MENU > System > Voice Recognition > TV Voice

Enable or disable the voice the TV uses to respond to your voice commands.

## Selecting a gender for the TV voice

(MENU/123) > MENU > System > Voice Recognition > Voice Gender

You can select the gender of the voice the TV will use when you use the Voice Recognition function.

## Changing the voice recognition language

(MENU/123) > MENU > System > Voice Recognition > Language [Try Now](#)

You can select a language to use with the Voice Recognition function.

 Interactive voice recognition is not available in some languages. If the selected language is not available, select a different language.

## Using interactive voice recognition at a short distance

You can search for content that is available in the TV program or execute various other functions without having to remember specific commands or keywords.

Activate **Voice Recognition** and say a command. See the examples below:

- **When you want to find a specific content:**

"\*\*(Title)" / "Find \*\*(title)"

- **When you want to know specific information:**

"What's the weather in \*\*(place name)?" / "What is the \*\*(company) stock price?" / "Show me the \*\*(team) score."

- **When you use the TV's function:**

"Set Sleep Timer (function name) in 30 minutes"

 Some sentences above may not be supported depending on the country.

## Using the voice recognition tutorial

(MENU/123) > MENU > Support > Voice Recognition Tutorial [Try Now](#)

The tutorial lets you familiarize yourself with the basics of using **Voice Recognition**. Run **Voice Recognition Tutorial** from the **Support** menu, or run **Voice Recognition** and say "Tutorial".

# Controlling the TV using Motions (Motion Control)

(MENU/123) > MENU > System > Motion Control [Try Now](#)

To use the Motion Control feature, you must install a separately-sold camera on the TV.

Motion Control is not available:

- When you are playing UHD-level video saved on a USB device
- When you are viewing a digital channel with UHD-level resolution
- When you are using the Samsung Smart Control or a mouse

 This function is not supported by some apps.

 For more information, refer to "Read Before Using Voice, Motion, or Face Recognition."

 **The optional TV camera must be connected to the dedicated USB port at the back of the TV. The other USB ports do not support the camera or Motion Control.**

## Testing ambient illumination using the TV camera

(MENU/123) > MENU > System > Motion Control > Motion Control Environment Test [Try Now](#)

Run this test before using Motion Control to ensure proper functionality.

1. Stand 5 to 11.5 feet (1.5 to 3.5 m) from the TV screen. Launch the Motion Control Environment Test, and then select Start. If the TV screen is reflecting light or there are objects moving in the background, the TV may not recognize the motion of your hand.
2. Face the TV camera, and follow the onscreen instructions.

## Checking ambient illumination (Motion control environment Check)

(MENU/123) > MENU > Support > Self Diagnosis > Motion Control Environment Check



You can test the ambient brightness levels around the TV camera and microphone to ensure that they are suitable for motion control use.

 The actual name may differ from specific geographical areas or models.

## Activating motion control

(MENU/123) > MENU > System > Motion Control > Motion Control [Try Now](#)

Face the TV camera. Lower your hand to a comfortable position. Raise your hand with your index finger fully extended upwards, and then move your hand slowly to the left or right. When your hand is successfully recognized by the TV camera, motion control is activated and a pointer and motion control icons appear on the screen.

-  To deactivate motion control, move your hand out of the range of the TV camera. To reactivate it, simply move your hand toward the TV camera within 3 seconds.
-  Motion Control may be terminated if your index finger is not fully extended or you move it too fast.

## Using the motion control tutorial

(MENU/123) > MENU > Support > Motion Control Tutorial [Try Now](#)

You can learn the basics of using motion control.

## Learning motion control basics

The following actions are available:

- **Moving the pointer**



Move your hand to move the pointer accordingly.

- **Selecting an item**



Fold down and raise your index finger to select items. You can select a TV menu or run a function. Keeping your index finger lowered is like holding down a remote control button.

- **Returning to the previous menu**

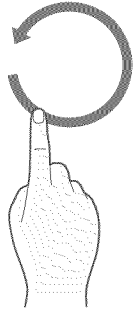

Make a circle with your hand in the counterclockwise direction to return to the previous menu screen.

- **Displaying the context-sensitive menu / Viewing broadcast information**

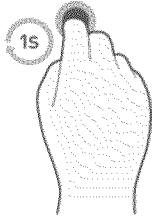

Fold your index finger down for 1 second and then raise it. This action displays the context-sensitive menu./ While viewing broadcasts, fold down your index finger for 1 second, and then raise it at any blank point on the screen. You can view the broadcast information saved automatically for all channels.

## Showing and hiding the animated motion guide

(MENU/123) > MENU > System > Motion Control > Animated Motion Guide **Try Now**

You can display an animated guide when motion control is activated.

 When you run an app using motion control for the first time, the animated guide appears.

## Selecting a pointer and adjusting pointer speed

(MENU/123) > MENU > System > Motion Control > Pointer Speed **Try Now**

Select a pointer and adjust its speed.

# Changing the motion control screens

## Changing the motion control screens while viewing a broadcast

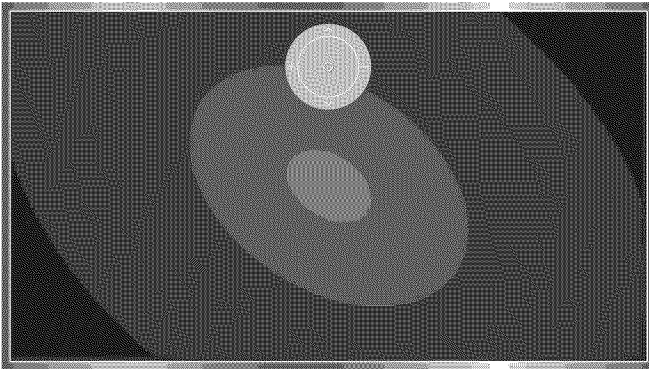

Direction Control Mode

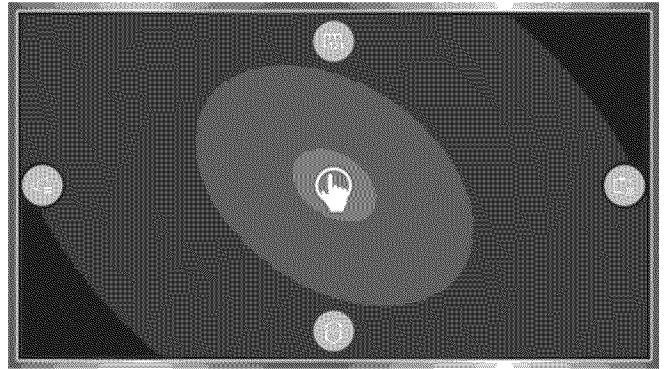





Motion Pointing Mode

- **Direction Control Mode**

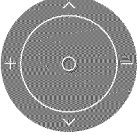

If you run Motion Control for the first time by raising your hand while viewing a broadcast, the Direction Control Mode screen appears. The screen contains the Direction Control icon.

- **Motion Pointing Mode**

Move to the center of the Direction Control icon with your index finger, and then fold down your index finger. The four icons allowing you to run the main functions of your TV appear. To switch to the Direction Control Mode screen, move your hand out of the screen and then raise your index finger at the screen.

Icon	Description
	Select + and - to adjust the volume. Select ^ and v to change the current channel. Select the point at the center of this icon to change to the Motion Pointing Mode screen.
	Displays the On-Screen Remote.
	Displays the channel list or information about the current program.
	Launches Smart Hub.
	Allows you to adjust the volume or select the speakers to use.

## Displaying the Direction Control icon while not viewing a broadcast

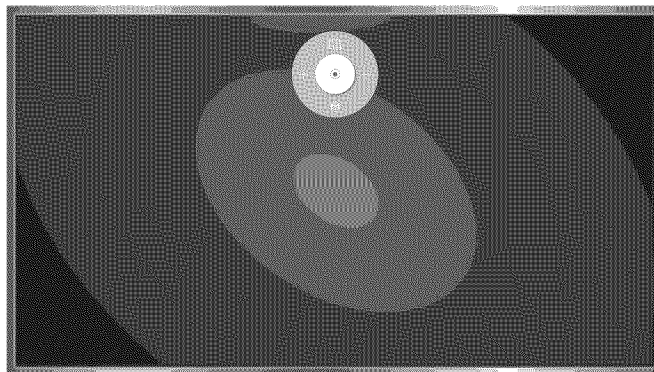

To display the Direction Control icon while not viewing a broadcast, move to the center of the top side of the screen, and then fold down your index finger. After the Direction Control icon appears, move the focus to the  or , and then fold down your index finger to display the On-Screen Remote or launch Smart Hub. The Direction Control icon disappears when there is no user action for 5 or more seconds.



Displaying the hidden direction control icon while using various services when not viewing broadcasts

# Using Face Recognition





You can register your face using the TV camera, and sign in to your Samsung accounts using the face recognition function. Only one face can be registered per account. Depending on the ambient illumination level and/or shadows over a face, the TV may have difficulty recognizing it.

-  To use the Face Recognition feature, you need to install a camera (sold separately) on the TV.
-  For more information, refer to "[Read Before Using Voice, Motion, or Face Recognition.](#)"
-  **The optional TV camera must be connected to the dedicated USB port at the back of the TV. The other USB ports do not support the TV camera or Face Recognition.**

## Registering your face to your Samsung account

(MENU/123) > MENU > Smart Hub > Samsung Account > Edit Profile

Select  after entering your account password. Select **Take Picture**, and then align your face within the red circle. When the circle turns green, the TV has registered your face.

-  To use this function, you must sign in to your Samsung account.
-  Your entire face must be visible to the camera. Avoid shadows over your face. Shadows prevent the camera from recognizing your face accurately.
-  Keep your expression as neutral as possible. Also, keep your mouth closed and as neutral as possible.
-  For more information, refer to "[Creating a Samsung account.](#)"

## Changing your login method to face recognition



(MENU/123) > MENU > Smart Hub > Samsung Account > Edit Profile

You can change your log in method to face recognition. To change the log in method, follow these steps:

1. Enter your password, and then select OK.
2. On the Edit Profile screen, select **Sign-in Method**. In the drop down list that appears, select **Profile image selection and facial recognition (Medium security)**.
3. Select Done.

## Signing in to a Samsung account using face recognition

(MENU/123) > MENU > Smart Hub > Samsung Account > Edit Profile

1. Select your Samsung account.
2. If you have set the Samsung account sign in option to Face Recognition, the TV automatically recognizes your face. If recognition fails, try again.
  -  Your entire face must be visible to the camera. Avoid shadows over your face. Shadows prevent the camera from recognizing your face accurately.
  -  Keep your expression as neutral as possible. Also, keep your mouth closed and as neutral as possible.
  -  Once recognition succeeds, the TV logs in to Smart Hub automatically. If the TV recognizes two or more registered faces, a list of corresponding accounts appears. Select the appropriate account. If the TV detects an unregistered face, it displays "Unregistered" on the screen.

# Viewing Digital Broadcast Information at a Glance

## Using the guide

(MENU/123) > MENU > Broadcasting > Guide **Try Now**

You can check the program schedules and set up a **Schedule Viewing** from the **Guide**.

You can move through the **Guide** in 2 hour jumps in either direction by pressing the ◀◀ or ▶▶ button. You can only view programs scheduled after the current time.

You can select the buttons that appear at the bottom of the screen by using the **POINTER** button of the Samsung Smart Control.

 The information in the **Guide** is for digital channels only. Analog channels are not supported.

 To view the **Guide**, you must first set the TV's clock (MENU > System > Time > Clock).

To access the **Guide** functions after launching the **Guide**, press and hold the Enter button on the remote control. A pop-up window listing the following functions appears.

- **Channel Filter**

Filters the channels displayed in the **Guide** by the following categories: **All**, and **Favorites 1 - Favorites 5**.

- **Schedule Manager**

Displays the **Schedule Manager**.

 For information about the **Schedule Manager**, refer to "**Setting Up a Schedule Viewing**."

- **Edit Favorite Channels**

Allows you to set a channel that you select in the **Guide** as a favorite.

- **View details**

Displays detailed information about a selected program. The program information may differ with the broadcast signal and may not be available at all for certain programs.

- Select a current program on another channel, and then select **View Details to Watch** or **Record** the program.
- Select an upcoming program, and then select **View Details** to set up a **Schedule Viewing** or **Schedule Recording**.

 Recording is not supported in the U.S.A and Canada.

 On the standard remote control, press the **INFO** button.

 For more information about watching or **Schedule Viewing**, refer to "**Setting Up a Schedule Viewing**."

 You can only view programs scheduled after the current time.







 For more information on **Schedule Recording**, refer to "**Recording Programs**."

- **Record**

Starts instant recording of the selected program.

## Checking current program info

You can view information about, start instant recording of, or apply the Timeshift function to a show that you are watching by pressing the Enter button on the Program Info window. In addition, you can view information about upcoming programs by using the left or right directional buttons, or you can set up a **Schedule Viewing** or **Schedule Recording** for a program by pressing the Enter button on the Program Info window displayed for that program.

-  Recording is not supported in the U.S.A and Canada.
-  On the standard remote control, press the INFO button.
-  To view program info, you must first set the TV's clock (MENU > System > Time > Clock).
-  For more information on **Schedule Recording**, refer to "Recording Programs."
-  Program information may differ with the type of incoming signal and may not be available at all for certain programs.
-  For more information on **Schedule Viewing**, refer to "Setting Up a Schedule Viewing."

## Changing the broadcast signal

(MENU/123) > MENU > Broadcasting > Antenna 



You can choose the appropriate DTV mode for your viewing environment. Select **Air** or **Cable**. **Air** is suitable for homes equipped with a separate, over-the-air antenna. **Cable** is suitable for homes that have subscribed to a local cable-service or satellite-service provider.

-  You do not need to use this function if your TV is connected to a cable or satellite box.

## Checking digital channel signal info and strength



(MENU/123) > MENU > Support > Self Diagnosis > Signal Information 

You can check the digital channel's signal information and strength.

-  If your TV is attached to a separate, over-the-air antenna, you can use the signal strength information to adjust the antenna for increased signal strength and improved HD channel reception.
-  This function is only available for digital channels.

# Recording Programs

The  appears next to programs and channels for which a Schedule Recording has been set.

-  This function is not available in the U.S.A. and Canada.
-  Read all precautions before using the recording feature. Refer to "Before Using the Recording and Timeshift Functions" for more information.

## Recording programs

You can record current and upcoming programs.

### Instant recording

To begin recording the current program right away, press the MENU/123 button, and then select the  button.

-  On the standard remote control, press the  button.

### Using the instant and schedule recording options from the guide

To start instant recording of a current program, select that program from the Guide, and then select Record. To start a schedule recording of a program that will air in the future, select that program from the Guide, press and hold the Enter button, select View Details, and then select Schedule Recording.

### Using the instant and schedule recording options from program info window

To start instant recording or a schedule recording of a program, press the Enter button. The Program Info window appears.

To start instant recording of a current program, select .

To start a schedule recording of a program that will air in the future, press the left or right directional button to move to that program, press the Enter button, and then select .

-  On the standard remote control, press the Enter button or INFO button.

### Using schedule recording to record on a specified date and time

(MENU/123) > Broadcasting > Schedule Manager > Schedule.

1. Select Schedule Recording.
2. Specify the Source, Channel, Repeat, Start Time, and End Time options for the program you want to record, and then select OK to finish.

## Using the functions available while recording a program

Press the Enter button while recording a program. The following buttons and the recording progress bar appear on the screen.

- **More Info**

Displays detailed information about the program being recorded.

 The program information may differ with the broadcasting signal and may not be available at all for certain programs.

- **REC Time**

Sets the recording time.

- **Stop Recording / Go to Live TV**



Stops recording. / Shifts viewing to live TV.

## Using the buttons on the remote control while recording a program

- **Pause / Play**

Press the ► or || button on the remote control to pause the recording screen or resume the paused recording screen.

When the recording is paused, you can use the following functions. However, no audio is heard while the recording is paused.

- **Step:** Press the MENU/123 button on the Samsung Smart Control, and then select the  button to scan through a video one frame at a time.
- **Slow Motion:** Press the MENU/123 button on the Samsung Smart Control, and then select the  button to play the video back at 1/2 the normal speed.

- **Rewind / Fast forward**

Press the MENU/123 button on the Samsung Smart Control, and then select  or  button to speed up rewind or fast forward.

 On the standard remote control, press the  or  button.

 This function is not available while you are watching a program that is currently being broadcast.

## Managing the schedule recording list

(MENU/123) > MENU > Broadcasting > Schedule Manager

You can change the settings of scheduled recording sessions or cancel scheduled sessions altogether.

## Viewing recorded programs

 > Featured > MY CONTENT

1. Select a USB recording device. The CONTENTS folder appears.
2. Select a recorded program file from the CONTENTS folder to play the selected file.

## Using the functions available while playing a recording



Press the Enter button. The following buttons appear. To hide the buttons, press the RETURN button.

 Buttons that appear are different depending on the file being played.

- **Pause / Play**

Pauses the recorded program file or resumes playing the file if paused.

When the video is paused, you can use the following functions. However, while the video is paused, there is no audio output.

- **Step:** Select the  button to scan through a video one frame at a time.
- **Slow Motion:** Select the  button to play the video back at 1/2 the normal speed.

- **Rewind / Fast forward**

Speeds up rewind/fast forward. To restore normal playback speed, press the  button.

- **Previous / Next**

To restart the current video from the beginning, select the  button once.

To play the next recorded program file, select the  button.

- **Repeat**

Plays the current file repeatedly or all files in the same folder repeatedly.

- **Highlight Player**

Displays highlights of the current recording.

 This function is only available if you have saved highlights of a program which was recorded in **Sports Mode**.

- **Options**

Function	Description
Picture Size	Changes the size of the screen. The supported picture sizes differ by video.
Caption	Turns the subtitles on or off.
Picture Mode	Displays a list of Picture modes and lets you change the mode.
Sound Mode	Displays a list of Sound modes and lets you change the mode.
Speaker List	Gives you a choice of speakers to play the audio through.
Multi-Track Sound	Displays a list of languages and lets you select the audio language that will be used when you play videos. This function is only available with files that support multi-track sound.
Information	Displays detailed information about the current file.

# Managing recorded files

 > **Featured** > **MY CONTENT**

Select a USB device containing recordings. A list of recordings appears.

## Using the functions on the recorded files screen

- **Filter**

Displays only files that match the selected filter.

- **Sort By**

Sorts files according to the selected viewing mode.

 This function is unavailable if **Filter** is set to **All**.

- **Delete**

Deletes selected files, except for locked files.

 This function is unavailable if **Filter** is set to **All**.

- **Play Selected**

Plays selected files. Select files from the file list and then select **Play**.

If the viewing mode is set to **Folder view**, you can only select files in the same folder. To add files contained in other folders to the playlist, change the viewing mode.

 This function is unavailable if **Filter** is set to **All**.

# Setting Up a Schedule Viewing

The  appears next to programs that have been configured for a schedule viewing.

 To set up a schedule viewing, you must first set the TV's clock (MENU > System > Time > Clock).

## Setting up a schedule viewing for a channel

### Setting up a schedule viewing for a digital channel

You can set up a schedule viewing for a digital channel on the Guide or Information screen.

- **The Guide screen**

On the Guide screen, press the left or right directional button to move to a program you would like to view, and then press the Enter button. You can select **Schedule Viewing** on the pop-up menu that appears. The program is scheduled for viewing.

- **The Program Info window**

Press the Enter button while you are watching the TV. The Program Info window appears. Press the left or right directional button to move to a program you would like to view, and then Press the Enter button. Select  that appears on the Program Info window. The program is scheduled for viewing.

 On the standard remote, press the Enter or INFO button.

### Setting up a schedule viewing an analog channel

(MENU/123) > MENU > Broadcasting > Schedule Manager 

You can set up a schedule viewing for an analog channel. Select **Schedule > Schedule Viewing**. Specify the **Source**, **Channel**, **Repeat**, and **Start Time** options for the program you want to watch, and then select OK to finish.

## Editing a schedule viewing

(MENU/123) > MENU > Broadcasting > Schedule Manager

On the Scheduled screen, select a schedule viewing. A pop-up menu appears. Select **Edit**. Change the time, days, or channel. Select OK when done.

## Canceling a schedule viewing

(MENU/123) > MENU > Broadcasting > Schedule Manager



On the Scheduled screen, select a schedule viewing. A pop-up menu appears. Select **Delete**. Select OK in the pop-up menu. The schedule viewing is removed.

 You can set up a maximum total of 30 **Schedule Viewing** and **Schedule Recording** entries.

# Using Timeshift

You can pause and rewind live TV as you would a DVD by using Timeshift.



Activating this function disables the **Broadcasting** function.

-  This function is not available in the U.S.A. and Canada.
-  Read all precautions before using the Timeshift function. For more information, refer to "Before Using the Recording and Timeshift Functions."

To activate the Timeshift function while watching TV, press the Enter button, and then select  on the Program Info window. The TV displays a progress bar and the following buttons at the top of the screen:

- **Information**

Displays detailed information about the current program.

-  The program information may differ with the type of incoming signal and may not be available at all for certain programs.
-  This button is only available when you are watching a live program.

- **Record**



Starts instant recording of the current program.



- **Go to Live TV / Stop Timeshift**

Shifts to live TV or exits Timeshift.

## Using the buttons on the remote control while using Timeshift

- **Pause / Play**

Press the  or  button on the remote control to pause or resume watching the current program while using the Timeshift function. The following functions are available while the current program is paused. However, while the current program is paused, there is no audio output.

- **Step:** Press the **MENU/123** button on the Samsung Smart Control, and then select the  button to scan through a video one frame at a time.
- **Slow Playback:** Press the **MENU/123** button on the Samsung Smart Control, and then select the  or  button to play the current program back at 1/2 the normal speed.

-  On the standard remote control, press the  or  button.

- **Rewind / Fast forward**

Press the **MENU/123** button on the Samsung Smart Control, and then select the  or  button to speed up rewind or fast forward.

-  On the standard remote control, press the  or  button.

-  The Fast Forward function is not available while you are watching a program that is currently being broadcast.



# Using the Channel List

(MENU/123) > MENU > Broadcasting > Channel List [Try Now](#)

By using the Channel List, you can change the channel or check programs on other digital channels while watching TV. To display the Channel List, place a finger on the POINTER button on the Samsung Smart Control, and then select the  icon that appears at the right side of the screen.

 On the standard remote control, press the CH LIST button.

The Channel List screen contains the following icons:

-  : An analog channel
-  : A favorite channel
-  : A locked channel

Press the left directional button. The following functions are available:



- **History**  
Displays a list of channels that you viewed recently.
- **Add a New List**  
Allows you to create a new channel list by adding channels from a favorites list.  
 This option is available only if you have registered one or more channels to at least one favorites list.
- **Added Ch.**  
Displays the selected channel list.
- **Options**

Option	Description
Antenna	Allows you to select Air or Cable as the DTV mode. Air is suitable for homes equipped with separate, over-the-air antennas. Cable is suitable for homes that subscribe to a local cable-service or satellite-service provider. You do not need to use this function if your TV is connected to a cable or satellite box.
Edit Channel Lists	Allows you to rearrange the order of channels in the channel list or remove channels from the channel list.
Edit Channel	Allows you to remove channels from the channel index, restore removed channels, and rename analog channels.
Edit Favorites	Sets favorite channels.  For more information, refer to "Creating a Personal Favorites List."

# Registering, Removing, and Editing Channels

(MENU/123) > MENU > Broadcasting > Edit Channel 

The Edit Channel screen icons indicate the following:

- **A** : An analog channel
-  : A favorite channel
-  : A locked channel

## Registering and removing channels

### Removing registered channels

You can remove a registered channel or all channels from the channel index. To remove a channel, select it, and then select **Delete**. To remove all channels, select **Options > Select All > Delete**.

### Adding back removed channels

You can add back removed channels from the **All** list only. Removed channels are displayed in gray in the **All** list. To display the **All** list, select **Options > Category > All**. Then, to add back a removed channel, select it, and then select **Add**. To add back all removed channels, select **Options > Select All > Add**.

## Editing registered channels

You can access the following options by selecting **Options** at the bottom left of the screen. The available options may differ with the broadcast signal.

- **Select All / Deselect All**

Selects or deselects all channels displayed on the **Edit Channel** screen.

- **Antenna**

Allows you to select **Air** or **Cable** as the DTV mode.

- **Category**

- Displays the channels of a selected category in the list. The channels stored in the TV are grouped into the following categories: **All** and **Added Ch.**

- **Edit Favorites**

Sets favorite channels.



For more information, refer to "Creating a Personal Favorites List."

- **Rename Channel**

Renames analog channels. The new name can be up to 5 characters long.

- **Information**

Displays detailed information about the current program.

## Using Program Rating Lock

(MENU/123) > MENU > Broadcasting > Program Rating Lock 

You can block programs based on their ratings by using **Program Rating Lock**. This function is useful for controlling what children watch on TV. **Program Rating Lock** does not block programs originating from external sources, such as Blu-ray players, DVD players, or USB files.

Every time you access **Program Rating Lock**, you must enter the security PIN. You must also enter this PIN to watch a blocked program. The default PIN is 0000. To change the PIN, go to **System > Change PIN**.

 The **Program Rating Lock** may not supported depending on the input signal you are using.

### Blocking programs based on their TV Rating

You can block TV programs based on their rating. To block content, select a rating category to lock. All programs at that level and higher are blocked and require the PIN to watch. To unblock a category, select the lock icon. To unblock all the categories in a row, select the lock under **ALL**.

#### Categories on the left:

- **TV-Y:** Young children
- **TV-Y7:** Children 7 and over
- **TV-G:** General audience
- **TV-PG:** Parental guidance
- **TV-14:** Viewers 14 and over
- **TV-MA:** Mature audience

#### Categories on the top:

- **ALL:** Lock all TV ratings.
- **FV:** Fantasy violence
- **V:** Violence
- **S:** Sexual situations
- **L:** Adult Language
- **D:** Sexually Suggestive Dialog

## Blocking movies base on their Movie Rating (MPAA)

You can block movies based on their MPAA rating. This rating system applies to all material with supplied ratings in the U.S.A.

### From the MPAA:

“The Motion Picture Association of America (MPAA) has implemented a rating system that provides parents or guardians with advanced information on which films are appropriate for children.”

Select a lock beside one of the rating categories to block that category and all higher categories. To unblock a category, select the lock icon.

- **G:** General audience (no restrictions).
- **PG:** Parental guidance suggested.
- **PG-13:** Parents strongly cautioned.
- **R:** Restricted. Children under 17 should be accompanied by an adult.
- **NC-17:** No children under age 17.
- **X:** Adults only.
- **NR:** Not rated.

## Blocking programs based on their Canadian English Rating

You can block programs based on their **Canadian English Rating**. This rating system applies to all rated material viewed on English-Canadian TV channels.

Select a lock beside one of the rating categories to block that category and all higher categories. To unblock a category, select the lock icon.

- **C:** Programming intended for children under age 8
- **C8+:** Programming generally considered acceptable for children 8 years and over to watch on their own
- **G:** General programming, suitable for all audiences.
- **PG:** Parental Guidance
- **14+:** Programming containing themes or content which may not be suitable for viewers under the age of 14
- **18+:** Adult programming

## Blocking programs based on their Canadian French Rating

You can block programs based on their **Canadian French Rating**. This rating system applies to all rated material viewed on French-Canadian TV channels.

Select a lock beside one of the rating categories to block that category and all higher categories. To unblock a category, select the lock icon.

**G: General**

**8 ans+:** Programming acceptable for children 8 years and over to watch on their own

**13 ans+:** Programming that may not be suitable for children under the age of 13

**16 ans+:** Programming not suitable for children under the age of 16

**18 ans+:** Programming restricted to adults

## Blocking Programs Based on their Downloadable U.S. Rating

You can block programs based on their **Downloadable U.S. Rating**. This rating system only applies to material originating from US DTV channels.

Parental restriction information is automatically downloaded while you watch DTV channels. This download may take several seconds. If the information is unavailable from the broadcasting station, the **Downloadable U.S. Rating** menu is deactivated.

Parental restriction levels differ with the broadcasting station. The default menu name and the **Downloadable U.S. Rating** name changes depending on the downloaded information.

Even when the on-screen display is set to another language, the **Downloadable U.S. Rating** menu appears only in English.

Select a lock beside one of the rating categories to block that category and all higher categories. To unblock a category, select the lock icon.

## Watching blocked / restricted programs

To watch a blocked program, enter the PIN when requested.

When initially showing a restricted program or movie, the screen is blank because the **Program Rating Lock** blocks it. Enter the PIN to unblock the program when a message appears requesting the code.

# Creating a Personal Favorites List

Favorite channels are highlighted in the **Edit Channel** and **Channel List** screens with the  symbol. You can create up to 5 favorite channel lists.

## Registering channels as favorites

(MENU/123) > MENU > Broadcasting > Edit Favorites

You can register multiple channels as favorites at the same time.

1. Select the channels that you want to add to your favorites list(s) from the list on the screen.
2. Select **Change Fav.** on the screen to select a favorites list.
3. Select **Add** on the screen. The TV adds the channels you selected to the favorites list you chose.

## Viewing and selecting channels on Favorites lists only

(MENU/123) > MENU > Broadcasting > Channel List

You can display a favorites list and select a channel using the channel up/down buttons.

1. Press the left directional button. A favorites list appears. Select **Change Fav.** to select a different favorite list if necessary.
2. Highlight a channel from the selected favorites list using the channel up/down buttons, and then select it. The channel changes.

 A favorites list can be selected only if it contains at least one favorite channel.

# Editing a Favorites List

(MENU/123) > MENU > Broadcasting > Edit Favorites

## Using the Edit Favorites screen menu items

You can access the following options by selecting Options on the Edit Favorites screen.

- **Select All / Deselect All**

Selects or deselects all channels saved on the TV.

- **Copy to Favorites**

Copies channels from one favorite channels list to another.

 For more information, refer to "Copying channels from one favorites list to another."

 This option is available only if you have registered one or more channels to at least one favorites list.

- **Rename Favorites**

Rename an existing favorite channels list.

 For more information, refer to "Renaming a favorites list."

 This option is available only if you have registered one or more channels to at least one favorites list.

- **Antenna**

Allows you to select **Air** or **Cable**.

- **Edit Channel**

Allows you to manage the channels saved on the TV.

 For more information, refer to "Registering, Removing, and Editing Channels."

## Removing channels from a favorites list

Select **Edit Favorites**. Select **Change Fav.** to move to the favorites list that has the channels you want to remove. Select the channels, and then select **Delete**.

## Rearranging a favorites list

Select **Edit Favorites**. Select **Change Fav.** to move to the favorites list that has the channels you want to rearrange. Select the channels, and then select **Change Order**. The **Change Order** highlight appears. Press the up/down arrow buttons to indicate the new location for the channels. Press the **Enter** button to set the channels into their new location.

## Renaming a favorites list

Select **Options > Rename Favorites**. Select the favorites list you want to rename. Enter a new name using the on-screen keyboard that appears, and then select **Done**. Select **OK**.

## Copying channels from one favorites list to another

Select **Edit Favorites**. Select **Change Fav.** to move to the source favorites list, and then select the channels to copy. Select **Options > Copy to Favorites**. Select the destination favorites list, and then select **OK**. Select **OK** again.

 **Copy to Favorites** is only available if there are channels in at least one favorites list.

# Making Sports Programs More Realistic with Sports Mode

(MENU/123) > MENU > System > Sports Mode or Soccer Mode [Try Now](#)

You can use **Sports Mode** to get optimal picture and sound settings for soccer events, making them appear and sound as if you are there. In addition, if a recording device is connected to the TV when you are using **Sports Mode**, you can view highlights extracted from the recorded sporting event automatically or manually.

 The actual name may differ with specific geographical area.

## Enabling sports mode

(MENU/123) > MENU > System > Sports Mode or Soccer Mode > Sports Mode or Soccer Mode

You can set **Sports Mode** to **On** to optimize the picture and sound modes of the TV automatically for soccer events.

 Enabling **Sports Mode** changes **Picture Mode** to **Stadium** and **Sound Mode** to **Stadium**, and disables some **Picture** and **Sound** menus.

## Extracting highlights automatically

(MENU/123) > MENU > System > Soccer Mode > Auto Highlights [Try Now](#)

You can set **Auto Highlights** to **On** to configure the TV to extract highlights of a sporting event automatically.

However, **Auto Highlights** is not available:

- When you are switching the input signal using the **SOURCE** button.
- When **3D** mode is active
- When **Audio Description** is on
- When you are viewing the content in **MY CONTENT**
- When the **Screen Mirroring** function is running
- When you are viewing highlights of the current soccer game in the **UHD** resolution by using the **Highlight Player** function

 This function is not available in the U.S.A. and Canada.

 The performance of **Auto Highlights** depends on the characteristics of the transmitted signal.

 It is advisable to use **Auto Highlights** only while watching a soccer game. If you use this function for other sporting events, it may display irrelevant picture frames.

## Using the functions available while watching sports in sports mode

You can use the following functions when you press the Enter button in sports mode.

 This function is not available in the U.S.A, and Canada.

- **Zoom**

Pauses the current screen and zooms in any part of the screen by using 4 directional buttons.

 On the standard remote control, press the **A** button.

 This function is not available when you are watching 3D channels or when **PIP** or **MY CONTENT** is active.

- **Recording**

Instantly records the game that you are currently watching on the TV.

 This function is only available if the TV supports the recording function.

- **More Info**

Displays detailed information about the current program.

 This function is only available while you are watching a live program.

## Using the functions available while recording sports in sports mode

You can use the following functions when you press the Enter button in sports mode.

- **Manual Highlight**

Saves a video from 10 seconds before you press the button to 10 seconds after.

 On the standard remote control, press the **B** button.

 You can set the TV to automatically save highlights without user intervention. Select **MENU > System > Sports Mode**, and then set **Auto Highlights** to **On**.

- **Recording Time**



Sets the recording time.

- **Stop Recording / Go to Live TV**

– Stops a recording when you are watching a live program.

– Switches to a live program when you are watching a recorded program.

- **Rewind / Fast Forward**

Press the **MENU/123** button on the Samsung Smart Control, and then select  or  button to speed up rewind or fast forward.

 On the standard remote control, press the  or  button.

- **Pause / Play**

Pauses or resumes the video.

- **Highlights Player**

Displays the **Highlights Player** screen and plays the highlights saved in the recorded file automatically or manually. **Highlights Player** is not available when:

- You are switching the input signal with the **SOURCE** button.
- 3D mode is active
- When **Video Description** is on

- **Watch Live TV at the same time**

Allows you to watch a current program in a PIP window while watching a recorded program. To exit PIP mode, press the button again. **Watch Live TV at the same time** is not available when:

- You are switching the input signal using the **SOURCE** button.
- 3D mode is active
- When **Video Description** is on
- When you are viewing a soccer game in the UHD resolution

 This function is only available while you are watching a recorded program.

## Viewing a game recorded in sports mode

You can view a recorded game on the **MY CONTENT** screen.



 This function is not available on certain models in specific geographical areas.

 For more information, refer to "[Viewing recorded programs.](#)"

# Making Sports Programs More Realistic with Hockey Mode

(MENU/123) > MENU > System > Hockey Mode > Hockey Mode

You can use **Hockey Mode** to get optimal picture and sound settings for hockey events, making them appear and sound as if you are there.



-  This function is available on certain models in specific geographical areas.
-  Enabling **Hockey Mode** changes the **Picture Mode** to **Stadium** and the **Sound Mode** to **Stadium**, and disables some **Picture** and **Sound** menus.
-  Press the **HOCKEY** button to turn **Hockey Mode** on or off.

## TV-Viewing Support Functions

### Showing captions

(MENU/123) > MENU > System > Accessibility > Caption 

You can watch TV broadcasts with captions. Press and hold the  button to turn the **Caption** function on or off.

-  This function is not available on certain models in specific geographical areas.
-  Captions are not displayed by programs that do not support captions.
-  On the standard remote control, press and hold the **CC** button to turn the **Caption** function on or off.

### Enabling captions

Select **System > Accessibility > Caption > Caption**

-  The TV cannot control or modify DVD or Blu-ray subtitles. To control DVD or Blu-ray subtitles, use the subtitle feature of the DVD or Blu-ray player and the player's remote control.

### Selecting the caption language

(MENU/123) > MENU > System > Accessibility > Caption > Caption Mode

- **Default / CC1 ~ CC4 / Text1 ~ Text4**

(Analog channels only) Operates in either analog TV channel mode or when a signal is supplied from an external device to the TV. (Depending on the broadcast signal, the analog caption function may or may not work with digital channels.)

- **Default / Service1 ~ Service6 / CC1 ~ CC4 / Text1 ~ Text4**

(Digital channels only) Works with digital channels. Service1 - Service6 may not be available in digital caption mode depending on the broadcast.

## Changing the font color, caption size, and font opacity

You can change the font color, background color, and size settings.

(MENU/123) > MENU > System > Accessibility > Caption > Digital Caption Options

- **Size**  
Changes the font size. Size is not supported by analog channels.
- **Font Style**  
Changes the font style for the subtitles.
- **Font Color**  
Changes the font color.
- **Background Color**  
Changes the caption's background color.
- **Window Color**  
Selects the color of the digital caption window.
- **Font Opacity**  
Changes the caption's opacity.
- **Background Opacity**  
Changes the background's opacity.
- **Window Opacity**  
Adjusts the transparency level of the digital caption window.
- **Edge Type**  
Selects the outline type for the digital captions.
- **Edge Color**  
Selects the color outline for the digital captions.
- **Return to Default**  
Restores all caption display options to the **Default** setting. The **Default** setting applies the TV station's transmitted settings to the captions.

 The foreground and background color and opacity settings cannot be the same.

## Enabling the audio guide for the video description

(MENU/123) > MENU > System > Accessibility > Video Description [Try Now](#)



You can activate the audio guide for the visually impaired. This function is only available with broadcasts that provide this service. Press and hold the  button on the Samsung Smart Control to turn Video Description on or off.

-  On the standard remote control, press and hold the CC button to turn the Video Description function on or off.

## Scanning for available channels

(MENU/123) > MENU > Broadcasting > Auto Program [Try Now](#)

Automatically scans and indexes all channels received through the TV's antenna input connector.

-  Do not use this function if your TV is connected to a cable or satellite box.
-  If the TV has saved channels, Auto Program deletes the existing list, and then saves the newly scanned channels.

## Selecting the broadcast audio language

(MENU/123) > MENU > Broadcasting > Audio Options [Try Now](#)

You can select the TV's audio language. This is the language you will hear while watching TV, if the language is included in the broadcast signal. Audio Options functions differently for analog and digital channels.

-  To view the current broadcast's audio signal information, press the INFO button on the standard remote control. Or, press the MENU/123 button on the Samsung Smart Control, and then select INFO on the On-Screen Remote.

## Selecting the Broadcast Audio Language for Digital Broadcasts

- **Selecting a Language** [Try Now](#)

Select Audio Options > Preferred Language, and then select a language. Digital programs that include the language you selected in their broadcast signal are automatically played using that language. If the language you selected is not supported by the broadcast signal, the TV will use the default audio language broadcast by the TV station.

## Selecting the Broadcast Audio Language and Other Options for Analog Broadcasts

- **Listening to Multi-Track Sound** 

Select **Audio Options** > **Multi-Track Sound**. Configure the audio for the current broadcast. **Multi-Track Sound** can be set to mono or stereo, depending on the broadcast signal or program. This option is automatically set to mono if the broadcast signal or program does not support stereo.

Select **Program** to see if the program you are watching is being transmitted with a track containing a simultaneous translation into a language you want. If it is, select the track to listen to the translation.

## Fine-tuning analog broadcasts

(MENU/123) > MENU > Broadcasting > Channel Settings > Fine Tune 

When analog pictures become shaky and full of noise, fine-tune the signal to clear up the picture.

 This function is only available for analog broadcasts.

## Removing pay channels

(MENU/123) > MENU > Broadcasting > Channel Settings > Clear Scrambled Channel

**Auto Program** scans and indexes all channels, both free and pay respectively. You can remove all scrambled pay channels from the channel list with **Clear Scrambled Channel**.

# Adjusting the Picture Quality

## Choosing a picture mode

(MENU/123) > MENU > Picture > Picture Mode 

You can select the picture mode that provides the best viewing experience.

- **Dynamic**  
Makes the picture clearer when the ambient lighting is so bright that it makes the picture difficult to see.
- **Standard**  
Is the default mode suitable for most environments.
- **Natural**  
Reduces eye strain.
- **Movie**  
Darkens the screen, reduces glare, and relieves eye fatigue. Use this mode while viewing the TV in a darkened room or watching a movie.
- **Entertain**  
Sharpens images for a more dynamic viewing experience.

 When the Input source is set to PC, **Standard** and **Entertain** modes are only available.

 When a PC is connected to the TV, but the **Entertain** mode is not available, set **Edit Device Type** to **DVI PC** or **PC**.

- **Stadium**  
When you set **Sports Mode** (MENU > System > Sports Mode or Soccer Mode > Sports Mode or Soccer Mode) to On, both **Picture Mode** and **Sound Mode** are automatically set to **Stadium**. The TV changes the picture and sound settings so that they are suitable for soccer events.

# Adjusting the picture quality

(MENU/123) > MENU > Picture

You can adjust the following picture quality settings manually for each combination of input source and picture mode.

- **Backlight** 

Adjusts the brightness of individual pixels. Decrease this brightness to reduce power consumption.

- **Contrast** 

Adjusts the screen contrast.

- **Brightness** 

Adjusts the overall brightness.

- **Sharpness** 

Sharpens or dulls the edges of objects.

- **Color** 

Adjusts the overall color saturation.

- **Tint (G/R)** 

Adjusts the ratio of green to red. Increase the green value to saturate the greens and the red value to saturate the reds.

 The TV saves the adjusted values for the current input source and picture mode. These values remain in effect each time you select the same input source and picture mode.

 The **Color** and **Tint (G/R)** settings cannot be adjusted when the TV is connected to a computer via an HDMI-to-DVI cable.

## Applying the current picture settings to other input sources

(MENU/123) > MENU > Picture > Apply Picture Mode 

You can apply the picture quality settings to the current source and other input sources.

- **All Sources**

Applies the settings to all external devices connected to the TV.





- **Current Source**

Applies the settings to the current source only.

# Adjusting advanced settings

(MENU/123) > MENU > Picture > Advanced Settings [Try Now](#)

You can fine-tune how images are displayed on the TV screen for the Standard and Movie picture modes.

-  **Advanced Settings** is only available when **Picture Mode** is set to **Standard** or **Movie**.
-  When the TV is connected to a computer via an HDMI-to-DVI cable, only **White Balance** and **Gamma** are available.
  - **Dynamic Contrast** [Try Now](#)  
Automatically adjusts the screen contrast for an optimal contrast setting.
  - **Black Tone** [Try Now](#)  
Adjusts the black color depth.
  - **Flesh Tone** [Try Now](#)  
Darkens or lightens skin tones.
  - **RGB Only Mode** [Try Now](#)  
Adjusts the red, green, and blue levels individually.
  - **Color Space** [Try Now](#)  
Adjusts the range of colors that can be displayed on the screen.
    - **Auto**: Automatically adjusts the color space to match the input signal.
    - **Native**: Applies a range of colors that is wider than the input signal.
    - **Custom**: Allows you to adjust the color space manually. Select **Color**, and then change its **Red**, **Green**, and **Blue** saturations. **Reset** allows you to restore the default values for **Color Space**.
      -  You can configure the **Color** function only when **Color Space** is set to **Custom**.
  - **White Balance** [Try Now](#)  
Adjusts the color temperature of the picture to make white objects look white and the overall picture appear natural.
    - **2 Point**: Allows you to adjust red, green, and blue luminosity with the offset menu and brightness with the gain menu. **Reset** allows you to restore the default values.
    - **10 Point**: Divides red, green, and blue into 10 sections each, and allows you to modify the white balance by adjusting the brightness of each section. **Level** allows you to select the section to adjust.
      -  You can use the **10 Point** function only when **Picture Mode** is set to **Movie**. This function may not be supported by some external devices.
  - **Gamma** [Try Now](#)  
Adjusts the primary color intensity.

# Adjusting picture options

(MENU/123) > MENU > Picture > Picture Options [Try Now](#)

You can adjust the picture options to optimize your viewing experience. Select a picture mode, and then adjust the picture options.

- **Color Tone** [Try Now](#)

Adjusts the color tone. The color tone you select is stored in the TV's memory. When you change the current picture mode, the stored color tone is applied to the new picture mode automatically.

 **Cool** and **Standard** are only available when **Picture Mode** is set to **Dynamic**.

 **Color Tone** is only available when the TV is connected to a computer via an HDMI-to-DVI cable.

- **Digital Clean View** [Try Now](#)

Reduces static and ghosting caused by a weak signal. When you select **Auto Visualization**, the TV displays the signal strength on the bottom of the screen. Green indicates the best possible signal.

 This function is available for analog channels only.

- **MPEG Noise Filter** [Try Now](#)

Reduces MPEG noise and improves video quality.

- **HDMI Black Level** [Try Now](#)

Compensates for effects caused by a low black level, such as low contrasts and dull colors.

 This function is only available when the input signal, connected to the TV via an HDMI connector, is set to RGB444.





- **Film Mode** [Try Now](#)

Optimizes the picture quality for movies.

 This function is only available when the input signal is TV, AV, Component (480i, 1080i), or HDMI (1080i).

- **HDMI UHD Color**

Allows you to set the **HDMI UHD Color** mode to **On** or **Off** for each HDMI connector on the TV. When set to **On**, the TV optimizes processing of UHD 50P/60P signals.

-  If you set the HDMI connection to **On**, the TV turns off and then on automatically.
-  The HDMI connection with **HDMI UHD Color** set to **Off** supports up to UHD 50P/60P 4:2:0 input signals, while the HDMI connection with **HDMI UHD Color** set to **On** supports up to UHD 50P/60P 4:4:4 and 4:2:2 input signals. For more information, refer to "[Supported Resolutions for each of UHD Input Signals](#)".
-  For the 7 series or higher models, each HDMI connection can be individually optimized for **HDMI UHD Color**. When you connect the TV to the external device that supports only UHD 24 or 30 Hz frequency or any FHD frequency, the HDMI UHD Color function may not be available. In this case, set **HDMI UHD Color** to **Off**.
-  For the 6 series models or lower, make sure to connect to the HDMI IN (STB/DVI) port of the TV.

- **Auto Motion Plus** [Try Now](#)

Removes blurring and judder from scenes with rapid movement. If you select **Custom**, you can configure **Blur Reduction** and **Judder Reduction** manually and set **LED Clear Motion** to **On** for a sharper LED image. To return to the default settings, select **Reset**.

-  When **LED Clear Motion** is set to **On**, the screen appears darker than when it is **Off**.

- **Smart LED**

Controls the brightness of individual areas on the screen to maximize contrast automatically.

-  This function is not available on certain models in specific geographical areas.

- **Cinema Black** [Try Now](#)

In **Movie** mode, this function dims the top and bottom areas of the video image to provide a more immersive viewing experience.

-  This function is not available on certain models in specific geographical areas.

# Viewing in 3D

 This function is only supported for the 7100 to 8500 and 710D to 850D series models.

(MENU/123) > MENU > Picture > 3D 

You can view 3D media content and broadcasts. To view 3D content, you need to wear current Samsung 3D Active Glasses. IR-type Samsung 3D Active Glasses and third-party 3D glasses are not supported.

 The Samsung 3D Active Glasses is not provided with the 7100 and 710D series models. And it may not be provided with the 7500 series model in specific countries. Make sure to purchase 3D glasses.





 Before viewing 3D content, carefully read the health and safety information concerning 3D viewing. For more information, refer to "3D precautions."

 Whether 3D video is displayed in true HD is usually determined by the quality and format of the video.

## Starting 3D

(MENU/123) > MENU > Picture > 3D

Put on and then turn on the Samsung 3D glasses, and then select a **3D Mode**. Note that the 3D modes that are available at any given time depend on the format of the 3D content you are watching.

-  (Off)  
Deactivates 3D viewing.
-  (Normal)  
Converts normal images to 3D images.
-  (L/R)  
Splits a single image into left and right overlapping images to create the 3D effect.
-  (T/B)  
Splits a single image into top and bottom overlapping images to create the 3D effect.

 The supported resolutions vary for each mode. For more information, refer to "Supported Resolutions for 3D Modes."

The ideal viewing distance is three times the height of the screen or more. 3D images may not appear if you do not adhere to the recommended viewing angle or distance.

The 3D function may not work properly if there is another 3D product or an electronic device running nearby. If there is a problem, keep other electronic devices as far away as possible from the 3D Active Glasses.

The left and right 3D images may initially overlap when the TV is turned on. It takes a moment for the display to optimize and the overlapping to stop.

When you use the 3D mode, note the following limitations:

- The 3D mode is automatically disabled when you launch Smart Hub.
- PIP cannot be used.
- Certain picture options are disabled.

# Adjusting 3D effects

(MENU/123) > MENU > Picture > 3D

Configures the viewpoint, depth, and other 3D settings for a custom viewing experience.

 All 3D effects with the exception of **3D Auto View** can only be used while watching 3D content.

- **3D Perspective**

Adjusts overall 3D perspective for images on the screen.

- **3D Depth**

Adjusts overall 3D depth for images on the screen.

 This function cannot be used if **3D Mode** is set to  (L/R) or  (T/B).

- **L/R Change** 

Switches the left image to the right image and vice versa.

- **3D → 2D** 

Converts 3D images to 2D images.

 This function is not available if **3D Mode** is set to  (Normal) or  (Off).

- **3D Auto View**

Activates **3D Mode** automatically whenever it detects 3D content or a 3D broadcast.

- **3D Optimize** 

Allows you to optimize 3D pictures with an adjustment bar.

 You might not be able to view the TV in 3D mode while some applications are running. To view the TV in 3D mode, exit those applications.





# Picture Support Functions

## Viewing a picture-in-picture (PIP)

(MENU/123) > MENU > Picture > PIP 

While viewing video from an external device such as a Blu-ray player on the main screen, you can watch TV broadcast in a picture-in-picture (PIP) window.

- **PIP**  
Activates/deactivates PIP.
- **Antenna**  
Selects **Air** or **Cable** as the digital channel mode.
- **Channel**  
Selects the PIP channel.
- **Size**  
Sets the PIP window size.
- **Position**  
Sets the PIP window position.
- **Select Sound**  
Selects the audio source. To adjust the connected audio device's volume, you must use the **Sound Share** function or connect the audio source to the TV's HDMI (ARC) port.

-  PIP cannot be used while **Smart Hub** or **3D** is active.
-  Playing a game or using the karaoke function on the main screen can result in lower PIP picture quality.
-  The PIP function is only available under the following conditions: 1) The main screen's source is a **Component** or **HDMI** connection, 2) The input resolution is less than **FHD** (Full HD).
-  The PIP window supports digital channels only and does not support UHD channels.

# Changing the picture size and position

## Changing the picture size

(MENU/123) > MENU > Picture > Picture Size > Picture Size [Try Now](#)

You can change the size of the picture displayed on the TV screen.

- **16:9**  
Sets the picture size to the 16:9 wide screen format.
- **Zoom**  
Magnifies 16:9 pictures vertically. A magnified picture can be moved up and down.
- **Custom**  
Magnifies or shrinks 16:9 pictures vertically and/or horizontally. A magnified or shrunk picture can be moved left, right, up, and down.
- **4:3**  
Sets the picture size to the basic 4:3 mode.

**⚠ Do not watch your TV in 4:3 mode for extended periods of time. This action can cause the black bars, which appear at the top, bottom, left, and right sides of the screen in 4:3 mode, to suffer "screen burn-in" and appear as temporary or permanent after images on the screen. This damage to the screen is not covered by your Warranty.**

**✎** Supported picture sizes differ with the input signal. For more information about supported picture sizes, refer to "Picture sizes and input signals."

## Fitting the picture to the screen

(MENU/123) > MENU > Picture > Picture Size > Fit to screen

You can configure the TV so that the full picture fits the screen without any cutoff in the size you have chosen.

 This function is not available when you set the **Picture Size** to the **4:3** mode.

## Adjusting the picture position

(MENU/123) > MENU > Picture > Picture Size > Zoom/Position

You can adjust the picture position.

 This function is only available when **Picture Size** is set to **Zoom** or **Custom**. However, you cannot change the picture position when the TV is tuned to a digital channel and **Picture Size** is set to **Custom**.

## Listening to audio only (Picture Off)

(MENU/123) > MENU > Picture > Picture Off 

You can turn off the screen and play only audio through the speakers. To turn the screen back on, press any button other than the Power and Volume buttons.

## Resetting the picture mode settings

(MENU/123) > MENU > Picture > Reset Picture 

You can reset the current picture mode to its factory defaults. This action does not affect the settings of other picture modes.

# Adjusting the Sound Quality

## Choosing a sound mode

(MENU/123) > MENU > Sound > Sound Mode [Try Now](#)

You can select a sound mode to optimize your listening experience.

- **Standard**  
Is the default mode suitable for most environments.
- **Music**  
Emphasizes music instead of voices.
- **Movie**  
Provides the best sound for movies.
- **Clear Voice**  
Emphasizes voices.
- **Amplify**  
Increases the overall intensity of high-frequency sound to help hearing-impaired listeners.
- **Stadium**  
When you set **Sports Mode** (MENU > System > Sports Mode or Soccer Mode) to On, Sound Mode is set to Stadium automatically so that the picture and sound settings are fixed at settings most suitable for soccer events.

# Applying sound effects

(MENU/123) > MENU > Sound > Sound Effect [Try Now](#)

You can apply sound effects to alter how the TV emits sound.

- **Virtual Surround** [Try Now](#)  
Produces sound that makes you feel like you are sitting in a movie theater or concert hall.
- **Dialog Clarity** [Try Now](#)  
Increases voice intensity to make dialog clearer.
- **Headphone Surround** [Try Now](#)  
Experience home theater-like surround sound through your headphones.
- **Balance** [Try Now](#)  
Allows you to adjust the sound settings of the left and right speakers for a better sound balance. To restore the defaults, select **Reset**.
- **Equalizer** [Try Now](#)  
Allows you to adjust the loudness of specific frequency ranges to control the richness of the sound. To restore the defaults, select **Reset**.

 This function is not available when you are listening to audio through external speakers.

 This function is only available when **Sound Mode** is set to **Standard**.

# Using the Sound Support Functions

## Selecting speakers

(MENU/123) > MENU > Sound > Speaker Settings > Speaker Select [Try Now](#)

You can select which speakers the TV uses for audio output.

-  When **Speaker Select** is set so that sound comes from external speakers only, the Volume and Mute buttons and some Sound functions are disabled.

## Specifying the TV's installation type

(MENU/123) > MENU > Sound > Speaker Settings > TV Installation Type

You can specify the TV's installation type, either **Wall Mount** or **Stand**, to optimize the TV's sound automatically.

## Listening to TV sound through a Samsung Bluetooth audio device

(MENU/123) > MENU > Sound > Speaker Settings > TV SoundConnect

You can connect Samsung Bluetooth audio devices to the TV. They must be paired using the TV's Bluetooth function. For more information on pairing, refer to the Samsung Bluetooth audio device's operating manual.

- **Add New Device**

Adds a new device to the list of paired devices. If **Add New Device** is set to **Off**, the connection signals from new devices are ignored.

- **Samsung Audio Device List**

Displays a list of paired Samsung audio devices. Select a device to display its menu options. You can activate/deactivate the audio device or remove it from the list.

-  This function is only available for Samsung audio devices that support **TV SoundConnect**.

-  **TV SoundConnect**, **Surround**, and Bluetooth headphones can't be used simultaneously.

-  Before using a Bluetooth device, refer to "[Read Before Using Bluetooth Devices](#)."

# Listening to TV sound through a Samsung Multiroom Link compatible speaker

(MENU/123) > MENU > Sound > Speaker Settings > Multiroom Link

You can connect a Samsung Multiroom Link compatible speaker to the TV to enjoy a richer sound.

 This function is not available on certain models in specific geographical areas.

- **Settings**

Sets the Samsung Multiroom Link compatible speaker(s) to one of the following options.

- **Surround**

Select this option when you want to enjoy a surround system using multiple Samsung Multiroom Link compatible speakers in a single space or room.

- **SoundBar+Surround**

Select this option when you want to enjoy a surround sound system by connecting a soundbar and two speakers to the TV in one space or room.

- **Volume Level**

Adjusts the volume of the speaker you have selected in the list of speakers.

- **Speaker Test**

Sends a test sound to each speaker to make sure that your Multiroom Link system works properly.

- **Edit Name**

Allows you to give a name to each speaker.

 The **Multiroom Link** function is only available when at least one Samsung Multiroom Link compatible speaker is connected to the TV.

 The sound quality may be affected by the condition of your wireless network.

 The **Multiroom Link** function is deactivated when you activate **Screen Mirroring**.

 The networked speakers may disconnect on their own, depending on your network environment.

 For more information, refer to the Multiroom Link manual on the Samsung web site. ([www.samsung.com](http://www.samsung.com) > OWNERS & SUPPORT > Manuals & Downloads)

 The audio from the secondary device(s) may lag behind the audio and video of the main device which is playing the source content.

## Listening to the TV through Bluetooth headphones

(MENU/123) > MENU > Sound > Speaker Settings > Bluetooth Headphones





You can connect Bluetooth headphones to the TV. They must be paired using the TV's Bluetooth function. For more information on pairing, refer to the Bluetooth headphone's operating manual.

- **Bluetooth Headphone List**

Displays a list of Bluetooth headphones that can be paired with the TV. Select a Bluetooth headphone to display its menu options. From this menu, you can activate/deactivate (i.e., pair/unpair) the Bluetooth headphone or remove it from the list.

- **Multi-Output Audio**

Allows you to listen to audio through the TV's speakers and the connected headphones simultaneously.

-  When **Multi-Link Screen** is terminated, the Bluetooth headphone is disconnected from the TV.
-  If the TV fails to find a headphone, place the headphone closer to the TV, and then select **Refresh**.
-  When you turn on a paired Bluetooth headphone, the TV detects it automatically, and then displays a pop-up window. Use this pop-up window to activate/deactivate the Bluetooth headphone.
-  Before using a Bluetooth device, refer to "Read Before Using Bluetooth Devices."

## Enabling digital audio output

(MENU/123) > MENU > Sound > Additional Settings [Try Now](#)

Since this Smart TV is Sony/Philips Digital Interface Format (S/PDIF)-enabled, you can set the TV to provide digital audio output to various digital audio devices, such as speakers, A/V receivers, and home theaters, by adjusting the following settings.

- **HDMI Audio Format**

Sets the format of the audio input signal so that it is suitable for the external device connected to one of the TV's HDMI ports.

- **Audio Format** [Try Now](#)

Selects the digital audio output (S/PDIF) format. The available formats depend on the input source.

- **Audio Delay** [Try Now](#)

Helps correct timing mismatches between the audio and video tracks when you are watching TV and listening to audio through a digital audio device. You can adjust the delay by up to 250 ms.

- **Dolby Digital Comp** [Try Now](#)

Sets the Dolby Digital compression mode.

- **HD Audio**

Provides the TV sound resampled at HD audio quality.



Standard audio signals are sampled at 48 kHz while HD audio signals are sampled at 96 kHz.



Some S/PDIF receivers may not be compatible. For incompatible receivers, deactivate this mode and use normal audio mode instead.



The HD audio signals available on the TV are not available on external audio players connected via HDMI, Bluetooth, or Wi-Fi networks.

- **Auto Volume** [Try Now](#)

Automatically adjusts the TV's volume level when you change channels, video sources, or content so that the volume level remains the same for all sources. **Auto Volume** can modify the volume up to 12 db to equalize the sound. **Normal** applies a normal level of volume adjustment, and **Night** applies a slightly lower volume level. This option is ideal for late-night TV viewing.



If you want to use the volume control of a connected source device to control the sound, deactivate **Auto Volume**. When you use **Auto Volume** with a source device, the device's volume control may not function properly.

## Listening to 3D audio in 3D mode

(MENU/123) > MENU > Sound > 3D Audio [Try Now](#)

You can adjust audio depth so that the TV provides immersive sound that matches the pop-up effect of the 3D video that you are viewing.



This function is only supported for the 7100 to 8500 and 710D to 850D series models.



This function is only available in 3D mode.

## Resetting all sound settings

(MENU/123) > MENU > Sound > Reset Sound [Try Now](#)



Resets all sound settings to the factory defaults.

# Setting the Time and Using the Timer

## Setting the current time

(MENU/123) > MENU > System > Time > Clock 



You can set the clock manually or automatically. Once the clock is set, you can view the current time on the TV anytime. Press the MENU/123 button, and then select INFO.

-  On the standard remote control, press the INFO button.
-  The clock must be reset every time the power is disconnected.

## Setting the clock using digital broadcast info

(MENU/123) > MENU > System > Time > Clock > Clock Mode 



You can have the TV automatically download time information from a digital channel and set the current time. To activate this function, set Clock Mode to Auto. If the TV is connected to a cable box through HDMI or Component connectors, you must set the current time manually.

-  This function works only when the TV's antenna jack is connected to either an antenna or a cable output and is receiving digital broadcasts.
-  The accuracy of the time information received may differ with the channel and signal.

## If the clock is wrong in auto mode...

(MENU/123) > MENU > System > Time > Clock > Time Offset 

You can offset the clock in 1-hour increments by as much as +/- 12 hours if the TV fails to display the correct automatically set time.

-  **Time Offset** adjusts the time through a network connection. This function is only available if Clock Mode is set to Auto and the TV is connected to the Internet through a local area network.
-  **Time Offset** adjusts the time if the TV fails to receive time information through normal digital broadcast signals.

## Setting the clock manually

(MENU/123) > MENU > System > Time > Clock > Clock Set 

You can set the clock manually. Set Clock Mode to Manual, and then input present date and time.

# Using the timers

## Using the sleep timer

(MENU/123) > MENU > System > Time > Sleep Timer [Try Now](#)

You can use this function to automatically shut off the TV after a pre-set period of time. You can set the timer in 30 minute increments, for up to 3 hours.

## Turning on the TV using the on timer

(MENU/123) > MENU > System > Time > On Timer [Try Now](#)

You can set On Timer to make the TV turn on automatically at a specific time. You can use up to three separate configurations: On Timer 1, 2, and 3. On Timer is only available when Clock has already been set.

- **Setup**

If you select **Manual**, you can highlight and select each day to select the specific days that you want On Timer to turn on the TV.

- **Time**

- **Volume**

- **Source**

From the list, select a signal source for the TV to use when it turns on. If you want to play content saved in a USB device or content from an HDMI or Component source, such as a DVD player, Blue-ray player, or set-top box, connect the device to the TV before you start On Timer setup. For On Timer to function, you must keep the device connected to the TV.

- **Antenna**







Allows you to select a broadcast signal source, **Air** or **Cable**, when source is set to **TV**.

- **Channel**

Allows you to select a channel when source is set to **TV**.

- **Music / Photo**

Allows you to specify a USB device folder containing music files in the music field and/or a folder containing photos in the photo field when source is set to **USB**. If you select both a folder that contains music files and a folder that contains photo files, the TV plays the music files and displays the photos at the same time.

-  If the folder that you choose has sub-folders, you can select a sub-folder in the same fashion.
-  This function does not work properly if the selected USB device does not contain media files or a folder has not been specified.
-  No slideshow starts if there is only one image file on the USB device.
-  Folders with long names cannot be selected.
-  Make sure to use different folder names for multiple USB devices.
-  Use a USB memory stick or multi-card reader. **On Timer** may not work with certain battery-powered USB devices, MP3 players, or PMPs because the TV may take too long to recognize the device.

## Turning off the TV using the off timer

(MENU/123) > MENU > System > Time > Off Timer 

You can set **Off Timer** to turn off the TV automatically at a specified time. You can set up three separate configurations: **Off Timer 1, 2 and 3**. **Off Timer** is only available when **Clock** has already been set.

- **Setup**

Sets days of the week that the TV is turned off automatically. If you select **Manual**, you can select each specific day.

- **Time**

Sets the time for the TV to turn off automatically.

# Using the Screen Burn Protection and Energy Saving Functions

## Preventing screen burn

(MENU/123) > MENU > System > Auto Protection Time [Try Now](#)

You can use the Screen Burn Protection function to protect the screen. Still images can leave burned-in after-images if left on the screen for a long period of time. Select a time setting from the list. If a still image is shown on the screen for longer than the time that you selected, the TV automatically activates the Screen Burn Protection function.

## Reducing the energy consumption of the TV

(MENU/123) > MENU > System > Eco Solution [Try Now](#)

You can adjust the brightness level of the TV and prevent overheating to reduce overall power consumption.

- **Energy Saving** [Try Now](#)

Allows you to select a brightness setting from the list to reduce the TV's power consumption.

- **Eco Sensor** [Try Now](#)

Automatically adjusts the brightness level of the TV, according to the ambient light level, to reduce power consumption. If the Eco Sensor has adjusted the screen's brightness level, you can select the **Min. Backlight** or **Min. Cell Light** (in applicable models) to manually adjust the minimum screen brightness.

- **No Signal Power Off** [Try Now](#)

Allows you to select a length of time from the list. If no signal has been received for the length of time you selected, the TV automatically cuts off the power to reduce power consumption.

- **Auto Power Off** [Try Now](#)

Automatically turns off the TV to prevent overheating when the TV remains on for the specified period of time without any user input.

- **Motion Lighting**

Adjusts the brightness in response to on-screen movements to reduce power consumption.

 This feature is only available when the **Picture Mode** is set to **Standard** and is not available in 3D mode.

 This function is deactivated when you adjust a picture quality setting, such as **Contrast** and **Brightness**.

# Using Anynet+ (HDMI-CEC)

You can use the TV's remote control to control external devices that are connected to the TV by an HDMI cable and that support Anynet+ (HDMI-CEC). Note that you can only set up and operate Anynet+ (HDMI-CEC) with the remote control.

## Setting up Anynet+ (HDMI-CEC)

(MENU/123) > MENU > System > Anynet+ (HDMI-CEC) [Try Now](#)

- **Anynet+ (HDMI-CEC)** [Try Now](#)

You can enable or disable Anynet+ (HDMI-CEC). Set to **Off** or **On** to disable or enable all Anynet+ related functions.

- **Auto Turn Off** [Try Now](#)

When set to **Yes**, turns off Anynet+ compatible external devices when the TV is turned off.

 This function is not supported by some Anynet+ compatible devices.

- **Device search** [Try Now](#)

Automatically searches for and identifies Anynet+ (HDMI-CEC) compatible external devices that are connected to the TV.

## Using Anynet+ (HDMI-CEC)

### Viewing Anynet+ (HDMI-CEC)-compliant devices

After connecting external devices to the TV, select (MENU/123) > MENU > System > Anynet+ (HDMI-CEC) > **Device Search**. The TV displays a list of Anynet+ (HDMI-CEC)-compliant devices that you can set up as Anynet+ (HDMI-CEC)-enabled devices (i.e., devices that can be controlled with the TV's remote control). To set up an Anynet+ (HDMI-CEC)-compliant device as an Anynet+ (HDMI-CEC)-enabled device, you must select it on the Source screen. Follow the instructions in the next section.

 If an external device is set up as both an Anynet+-enabled device (i.e., a device that can be controlled with the TV's remote control) and a Universal Remote-enabled device (i.e., a device that can be controlled with the Universal Remote), it can be only controlled with the Universal Remote.

## Setting up as an Anynet+ (HDMI-CEC)-enabled device







1. Press the SOURCE button. The Source screen appears. Select a connected device, and then press the down directional button.
2. Select Anynet+ (HDMI-CEC) from the menu. The selected device is set up as an Anynet+ (HDMI-CEC)-enabled device. The following menu options are available.

 The menu options displayed on the menu may differ by external device.

- **Anynet+ (HDMI-CEC)**

Sets up the selected device as an Anynet+ (HDMI-CEC)-enabled device, and then displays a list of all external devices connected to the TV. If you select an external device in the list, it is used as the input source so that you can watch TV through that device. If you select **View TV**, Anynet+ (HDMI-CEC) is exited so that you can watch TV without intervening of any external device.

## Read before connecting an Anynet+ (HDMI-CEC)

-  You can configure the TV's Universal Remote to control to control third-party cable boxes, Blu-ray players, and home theaters that do not support HDMI-CEC. For more information, refer to "Controlling External Devices with the TV Remote - Using the Universal Remote."
-  Anynet+ cannot be used to control external devices that do not support HDMI-CEC.
-  Anynet+ (HDMI-CEC)-enabled devices must be connected to the TV with an HDMI cable. Note that some HDMI cables may not support Anynet+ (HDMI-CEC).
-  The TV remote control may not work under certain circumstances. If this occurs, set up the device as the Anynet+ (HDMI-CEC)-enabled device again.
-  Anynet+ (HDMI-CEC) works only with external devices that support HDMI-CEC and only when those devices are either in standby mode or turned on.
-  Anynet+ (HDMI-CEC) can control up to 12 compliant external devices (up to 3 of the same type) except for home theaters. Anynet+ (HDMI-CEC) can control only one home theater system.
-  To listen to 5.1-channel audio from an external device, connect the device to the TV via an HDMI cable and connect the home theater system directly to the TV's digital audio output connector.

# Updating the TV's Software



(MENU/123) > MENU > Support > Software Update [Try Now](#)

You can view your TV's software version and update it if necessary.

## Updating the TV's software to the latest version

(MENU/123) > MENU > Support > Software Update > Update now [Try Now](#)



You can update your TV's software by downloading the update from the Internet directly to your TV or copying the update from a USB device that contains it to your TV.

-  This function requires an Internet connection.
-  Save the update package in the USB device's top-level folder. Otherwise, the TV will not be able to locate the update package.
-  **DO NOT turn off the TV's power until the update is complete. The TV will turn off and on automatically after completing the software update. All video and audio settings return to the default settings after a software update.**

## Updating the TV automatically

(MENU/123) > MENU > Support > Software Update > Auto Update [Try Now](#)

If the TV is connected to the Internet, you can have the TV's software update itself automatically while you are watching the TV. When the background update is completed, it is applied the next time the TV is turned on.

-  This function may take a longer time if a different networking function is running concurrently.
-  This function requires an Internet connection.
-  If you agree to the Smart Hub terms and conditions, **Auto Update** is set to **On** automatically. If you do not want the TV's software to update itself automatically, set **Auto Update** to **Off**.

# Protecting the TV from Hacking and Malicious Code

(MENU/123) > MENU > System > Smart Security

You can use **Smart Security** to protect the TV from hacking and malicious code when it is connected to the Internet.

## Checking the TV and connected storage for malicious code

(MENU/123) > MENU > System > Smart Security > Scan

You can scan the TV and connected media to detect the presence of malicious code. If there is no malicious code detected, a notification window appears on the screen.

### If malicious code is detected...

If malicious code is found, the results of the scan will appear on the screen. This result window displays all malicious code found. You can either quarantine (isolate) the code or block it from executing.

1. Select all the malicious code to either quarantine or block.
2. Select **Isolate** or **Block**. These options relocate the selected malicious code to the **Isolated List** or **Blocked List**.

 The **Isolated List** displays all quarantined malicious codes.

 The **Blocked List** displays all blocked malicious codes. You can also quarantine or allow codes from this list.

# Configuring additional functions



(MENU/123) > MENU > System > Smart Security > Settings

- **Antivirus**  
Monitors the TV in real-time to prevent viruses from infecting the TV.
- **Network Security**  
Protects the TV from hacking to minimize a leaks of private information.
- **Camera**  
Permits the cameras connected to the TV to be used.
- **Microphone**  
Permits the microphones connected to the TV to be used.
- **Auto Scan**  
Makes the TV automatically scan itself and any connected storage media when it is turned on.
- **Auto Isolate**  
Adds malicious codes found during the scanning process to the Isolated List automatically.

# Using Other Functions

## Running the accessibility functions quickly



You can use the **Accessibility Shortcuts** menu to quickly run the accessibility functions for the impaired. Press and hold the  button on the Samsung Smart Control. The **Accessibility Shortcuts** menu lists the **Voice Guide**, **Video Description**, **Caption**, **Menu Transparency**, **High Contrast**, **Enlarge**, **Learn Remote Control** and **Multi-Output Audio** menu options.

-  With **Accessibility shortcuts** menu, some functions are not available in specific countries.
-  On the standard remote control, press and hold the **CC** button.
-  Even if **Voice Guide** is set to **Off** or the **Mute** mode is activated, you can run the **Voice Guide** function from the **Accessibility Shortcuts** menu.

## Enabling voice guides for the visually impaired

(MENU/123) > MENU > System > Accessibility > Voice Guide

You can activate voice guides that describe the menu options aloud to aid the visually impaired. To activate this function, set **Voice Guide** to **On**. With **Voice Guide** on, the TV provides voice guides for channel change, volume change, information on current and upcoming programs, schedule viewing, other TV functions, and various content on **Web Browser**, in **Search**, or in **MY CONTENT**.

-  The **Voice Guide** is provided in the language that is specified on the **Menu Language** screen. However, some languages are not supported by **Voice Guide** even though they are listed in the **Menu Language** screen. **English** is always supported.
-  If **Voice Guide** is set to **On**, the Samsung Smart Control's motion sensor does not work. To use the motion sensitivity sensor, set **Voice Guide** to **Off**.
-  If **Voice Guide** is set to **On**, the **Motion Control** function is disabled. To enable this function again, set **Voice Guide** to **Off**.

## Changing the volume, speed, and pitch of the voice guide

You can configure the volume, speed, pitch, and level of the **Voice Guide**.

- **Volume**  
Changes the **Voice Guide**'s volume level.
- **Speed**  
Changes the **Voice Guide**'s tempo.
- **Pitch**  
Tunes the pitch of the **Voice Guide**.

## White text on black background (high contrast)

(MENU/123) > MENU > System > Accessibility > High Contrast

You can change major service screens to white text on a black background or change the transparent TV menus to opaque so that text can be more easily read. To activate this function, set **High Contrast** to **On**.

## Adjusting the menu transparency

(MENU/123) > MENU > System > Accessibility > Menu Transparency **Try Now**

You can adjust the menu's transparency.

-  Setting **High Contrast** (MENU > System > Accessibility > High Contrast) to **On** automatically switches the menu display mode to opaque. You cannot manually change the **Menu Transparency** settings.

## Enlarging the font (for the visually impaired)

(MENU/123) > MENU > System > Accessibility > Enlarge **Try Now**

You can enlarge the size of the font on the screen. To activate, set **Enlarge** to **On**.

## Learning about the remote control (for the visually impaired)

(MENU/123) > MENU > System > Accessibility > Learn Remote Control

This function helps individuals with a visual impairment to learn the positions of the buttons on the remote control. When this function is activated, you can press a button on the remote control and the TV will tell you its name. To return to the previous screen, press the **RETURN** button twice. To exit, press the **EXIT** button twice.

-  This function is only available in the U.S.A. and Canada.

## Listening to the TV through Bluetooth headphones (for the hearing impaired)

(MENU/123) > MENU > Sound > Speaker Settings > Bluetooth Headphones > Multi-Output Audio

You can turn on both the TV speaker and Bluetooth headphones at the same time. When this function is active, you can set the volume of the Bluetooth headphones to be louder than that of the TV speaker.

-  When you connect the Bluetooth headphones to the TV, **Multi-Output Audio** menu is activated. For more information about connecting Bluetooth headphones to the TV, refer to "**Listening to the TV through Bluetooth headphones.**"

## Changing the menu language

(MENU/123) > MENU > System > Menu Language 





You can use this function to change the menu language. Choose a language from the list.

## Setting up a password

(MENU/123) > MENU > System > Change PIN 

You can set a Personal Identification Number (PIN) to lock channels, reset the TV, and change TV settings.

The PIN input window appears. Enter a PIN. Enter it again to confirm it. The default PIN is 0000.

-  If you forget your PIN, you can reset it with your remote control. With the TV turned on, press the following buttons on the remote control in the order shown to reset the PIN to 0000:  →  (Volume Up) → RETURN →  (Volume Down) → RETURN →  → RETURN.

## Checking Notifications

(MENU/123) > MENU > System > Notifications





You can view the list of event messages generated by the TV. **Notifications** appear on the screen when events such as an update release for an app or Samsung Account login/logout occurs.

-  To delete all notifications, select **Delete All**.
-  To check the SMART TV's service notifications in a web browser, select **Service Notice**.

## Enabling game mode

(MENU/123) > MENU > System > General > Game Mode 

You can enable the game mode to optimize the TV's settings for playing video games with a gaming console, such as a PlayStation™ or Xbox™.

-  The game mode is not available for normal TV viewing.
-  The screen may shake somewhat.
-  When **Game Mode** is enabled, **Picture Mode** and **Sound Mode** are switched to **Game** automatically.
-  To use a different external device, first disconnect the game console and disable **Game Mode**.

## Richer colors and superior picture quality (BD Wise)

(MENU/123) > MENU > System > General > BD Wise [Try Now](#)

You can enhance colors and picture quality if you connect a Samsung DVD player, Blu-ray player, or home theater system that supports BD Wise. When BD Wise is enabled, it automatically optimizes the TV's resolution.

 This function is only available when the external device is connected via an HDMI cable.

## Enabling/Disabling sound feedback

(MENU/123) > MENU > System > General > Sound Feedback [Try Now](#)

You can use Sound Feedback to get audio cues as you navigate through menus and select menu options. You can set it to Low, Medium, High, or Off.

## Locking/Unlocking the Control Stick

(MENU/123) > MENU > System > General > Panel Lock [Try Now](#)

You can lock and unlock the front panel buttons (menu, channel, and volume) of the TV and the control stick on the back of the TV.

## Showing/Hiding the Samsung logo while booting

(MENU/123) > MENU > System > General > Boot Logo [Try Now](#)



You can enable or disable the Samsung logo display that appears when the TV starts up.

 This function is not available when Samsung Instant On is set to On.

## Enabling the TV to boot faster

(MENU/123) > MENU > System > General > Samsung Instant On



You can set Samsung Instant On to On so that the TV boots up faster.

-  When Samsung Instant On is set to On, the use history of the apps that you used on the TV may be stored in the TV.
-  The Samsung Instant On function works when you turn on the TV while its power cable is still connected after you set Samsung Instant On to On. If you disconnect, reconnect the power cable, and then turn on the TV, this function does not work.
-  Even if the Samsung Instant On function is on, the power consumption while the TV is turned off meets the standby power consumption specification presented on the product label.

## Registering the TV as a DivX-certified device (watching for pay DivX movies)

(MENU/123) > MENU > System > DivX® Video On Demand

You can watch DivX DRM protected movies on the TV only if it is registered as a DivX-certified device.

-  Digital Rights Management (DRM) functions as a technical security mechanism to protect the content provider's copyright.
-  You can watch recorded movies or free DivX movies without registration.
-  Visit the DivX website (<http://www.divx.com>) and log in to your user account before registering the TV as a DivX-certified device. If you do not have an account, create one.

## Restoring the TV to the factory settings

(MENU/123) > MENU > Support > Self Diagnosis > Reset **Try Now**

You can restore all TV settings (excluding the Internet and network settings) to the factory defaults.



1. Select **Reset**. The security PIN entry window appears.
2. Enter the security PIN, and then select **Yes**. All settings are then reset. The TV turns off and on again automatically and displays the **Setup** screen.

 For more information on **Setup**, refer to the user manual that came with the TV.

## Using the TV as a display model (for retail stores)

(MENU/123) > MENU > Support > Use Mode **Try Now**

You can turn the TV into a display model for retail environments by setting Use Mode to **Store Demo**.

-  For all other uses, select **Home Use**.
-  With **Store Demo**, some functions are disabled, and the TV automatically resets itself after a preset amount of time.

# Getting Support

## Getting support through Remote Management

(MENU/123) > MENU > Support > Remote Management [Try Now](#)

You can use this feature to let Samsung Electronics diagnose your TV remotely when you need assistance with your TV. You will need to read and agree to the service agreement before using this feature.

 This function requires an Internet connection.





### Getting remote support

You can get one-on-one support offered by a Samsung Remote Support service technician who can do the following remotely.

- **Diagnose** your TV
- **Adjust the TV settings** for you
- Reset your TV to its factory settings
- Install recommended **firmware updates**

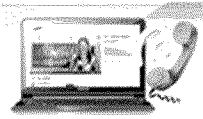
### How does remote support work?



You can get Samsung Remote Support easily by following these steps:

	Call the Samsung Contact Center and ask for remote support.
	Open the menu on your TV, and then go to the Support section.
	Select Remote Management, and then read and agree to the service agreements. When the PIN screen appears, provide the PIN number to the agent.
	The agent accesses your TV.

## Finding the contact information for service

(MENU/123) > MENU > Support > Contact Samsung

You can view the address of the Samsung website, the call center phone number, your TV's model number, your TV's software version, the Smart Hub info, and other information you may need to get service support from a Samsung call agent or the Samsung website.

 To view the Open Source License, press the  button.

## Requesting service

(MENU/123) > MENU > Support > Request Support

You can request a service when you encounter a problem with the TV. Select **Request Support**, and then agree to the terms and conditions for the service request. Select **Request Support** again, select the item matching the problem that you encountered, and then select **Send**.

 This function is not available in specific geographical areas.

# There Is a Problem with the Picture



## Testing the picture

(MENU/123) > MENU > Support > Self Diagnosis > Picture Test

Before you review the list of problems and solutions below, use Picture Test to determine if the problem is caused by the TV. The Picture Test displays a high definition picture you can examine for flaws or faults.

The problem	Try this!
Flickering and Dimming	If your Samsung Television is flickering or dimming sporadically, you may need to disable some of the energy efficiency features. Disable Energy Saving ((MENU/123) > MENU > System > Eco Solution > Energy Saving) or Eco Sensor ((MENU/123) > MENU > System > Eco Solution > Eco Sensor).
Component Connections/Screen Color	If the color on your Samsung television screen is not correct or the black and white colors are off, run Picture Test ((MENU/123) > MENU > Support > Self Diagnosis > Picture Test). If the test results indicate that the problem is not caused by the TV, do the following: <ul style="list-style-type: none"> <li>• Confirm that the TV's video input connectors are connected to the correct external device video output connectors.</li> <li>• Check the other connections as well. If the TV is connected to an external device via a component cable, confirm that the Pb, Pr, and Y jacks are plugged into their proper connectors.</li> </ul>
Screen Brightness	If the colors on your Samsung TV are correct but just a little too dark or bright, try adjusting the following settings first. <ul style="list-style-type: none"> <li>• Go to the Picture menu and adjust the Backlight, Contrast, Brightness, Sharpness, Color, and Tint (G/R) settings.</li> </ul>
Ghosting, Blurring, or Juddering	If you notice ghosting or blurring on the screen, use the Auto Motion Plus function ((MENU/123) > MENU > Picture > Picture Options > Auto Motion Plus) to resolve the issue.
Unwanted Powering Off	If your Samsung TV appears to turn off by itself, try disabling some of the TV's energy efficiency functions. See if Sleep Timer ((MENU/123) > MENU > System > Time > Sleep Timer) has been enabled. The Sleep Timer automatically turns the TV off after a specified period of time. If the Sleep Timer has not been enabled, see if No Signal Power Off ((MENU/123) > MENU > System > Eco Solution > No Signal Power Off) or Auto Power Off ((MENU/123) > MENU > System > Eco Solution > Auto Power Off) has been enabled and disable them.
Problems Powering On	When the TV is turned on, the remote control receiver flashes 5 times before the screen turns on. If you are having problems powering on your Samsung television, there are a number of things to check before calling the service department. Confirm that the TV's power cord is connected correctly at both ends and that the remote control is operating normally. Make sure that the antenna cable or cable TV cable is firmly connected. If you have a cable or satellite box, confirm that it is plugged in and turned on.

The problem	Try this!
Unable to find a Channel	If your TV is not connected to a cable or satellite box, run Setup ((MENU/123) > MENU > System > Setup) or Auto Program (Broadcasting > Auto Program).
The TV image does not look as good as it did in the store.	Store displays are all tuned to digital, HD (high definition) channels. If you have an analog cable/set top box, upgrade to a digital set top box. Use HDMI or Component cables to deliver HD (high definition) picture quality. Many HD channels are upscaled from SD (Standard Definition) content. Look for a channel that is broadcasting true HD content. <ul style="list-style-type: none"> <li>• Cable/Satellite Subscribers: Try HD channels from the channel lineup.</li> <li>• Air/Cable Antenna Connection: Try HD channels after running the Auto Program function.</li> </ul> Adjust the cable or satellite box's video output resolution to 1080i or 720p.
The picture is distorted.	The compression of video content may cause picture distortions, especially in fast moving pictures from sports programs and action movies. A weak or bad quality signal can cause picture distortions. This is not an issue with the TV. Mobile phones used close to the TV (within 3.2 ft) may cause noise in analog and digital channels.
The color is wrong or missing.	If you're using a Component connection, make sure that the Component cables are connected to the correct jacks. Incorrect or loose connections may cause color problems or a blank screen.
The color is poor or the picture is not bright enough.	Go to the Picture menu and then adjust the Picture Mode, Brightness, Sharpness, and Color settings. See if Energy Saving ((MENU/123) > MENU > System > Eco Solution > Energy Saving) has been enabled. Try resetting the picture. (Picture > Picture Reset)
There is a dotted line on the edge of the screen.	Change Picture Size to 16:9.
The picture is black and white.	If you are using AV composite input, connect the video cable (yellow) to the TV's green component jack.

-  If the test picture does not appear or there is noise or distortion, the TV may have a problem. Contact Samsung's Call Center for assistance.
-  If the test picture is displayed properly, there may be a problem with an external device. Please check the connections.
-  If the problem persists, check the signal strength or refer to the external device's user manual.

# I Can't Hear the Sound Clearly

## Testing the sound

(MENU/123) > MENU > Support > Self Diagnosis > Sound Test [Try Now](#)

If the TV plays the Sound Test melody without distortion, there may be a problem with an external device or the broadcast signal's strength.

The problem	Try this!
There is no sound or the sound is too low at maximum volume.	Check the volume control of the device (cable or satellite box, DVD, Blu-ray, etc.) connected to your TV.
The picture is good but there is no sound.	Set (MENU/123) > MENU > Sound > Speaker Settings > Speaker Select to TV Speaker. If you are using an external device, check the device's audio output option. (For example, you may need to change your cable box's audio option to HDMI if the box connected to your TV is using an HDMI cable.) To listen to computer sound, connect an external speaker to the computer's audio output connector. If your TV has a headphone jack, make sure there is nothing plugged into it. Reboot the connected device by disconnecting and then reconnecting the device's power cable.
The speakers are making an odd sound.	Make sure that the audio cable is connected to the correct audio output connector on the external device. For antenna or cable connections, check the signal information. A low signal level may cause sound distortions. Run Sound Test ((MENU/123) > MENU > Support > Self Diagnosis > Sound Test).

# I Can't See 3D Images Clearly

 This function is only supported for the 7100 to 8500 and 710D to 850D series models.

## Testing 3D picture quality

(MENU/123) > MENU > Support > Self Diagnosis > 3D Picture Test 

If the test picture does not appear or there is noise or distortion, the TV may have a problem. Contact Samsung's Call Center for assistance.

The problem	Try this!
The 3D glasses are not working correctly.	Make sure the glasses are powered on. The 3D feature may not work properly if there is another 3D product or an electronic device running nearby. If there is a problem, keep other electronic devices as far away as possible from the 3D Active Glasses.
I can't see 3D images clearly.	The ideal viewing distance is three times or more the height of the screen. We also recommend watching 3D content with your eyes level with the screen.
The batteries in the 3D glasses are discharged.	Turn off the 3D glasses when they are not in use. If you leave the 3D glasses on, the battery lifespan is shortened.

 To test 3D picture quality, you must be wearing 3D glasses and the glasses and the TV must be paired.

## There Is a Problem with the Broadcast

The problem	Try this!
The TV is not receiving all channels.	<ul style="list-style-type: none"><li>• Confirm that the coaxial cable is securely connected to the TV.</li><li>• Run Setup ((MENU/123) &gt; MENU &gt; System &gt; Setup) or Auto Program ((MENU/123) &gt; MENU &gt; Broadcasting &gt; Auto Program).</li><li>• If you are using an antenna, verify it is positioned correctly and all the connections are secure.</li></ul>
There are no captions with digital channels.	Go to Caption ((MENU/123) > MENU > System > Accessibility > Caption) and change the Caption Mode. Some channels may not have caption data.
The picture is distorted.	The compression of the video content may cause picture distortions. This is especially true with fast moving pictures from sports programs and action movies. A weak signal can cause picture distortions. This is not a problem with the TV.

## My Computer Won't Connect

The problem	Try this!
The "Mode Not Supported" message appears.	Set your PC's output resolution so it matches a resolution supported by the TV.
The video is OK but there is no audio.	If you are using an HDMI connection, check the audio output setting on your PC. If you are using an HDMI-to-DVI cable, a separate audio cable is required.

## The TV Won't Connect to the Internet

The problem	Try this!
The wireless network connection failed.	Confirm your wireless modem/router is on and connected to the Internet.
The software update over the Internet has failed.	Check the network connection status ((MENU/123) > MENU > Network > Network Status). If the TV is not connected to a network, connect to a network. The upgrade stops if you already have the latest software version.

## The Schedule Recording/Timeshift Function Isn't Working

 This function is not available in the U.S.A. and Canada.

The problem	Try this!
Schedule Recording cannot be used.	Check if there is a USB device connected to the TV. Recording will automatically stop if the signal becomes too weak. The Timeshift function will not work if there isn't enough storage space on the USB device.

# Anynet+ (HDMI-CEC) Isn't Working

The problem	Try this!
Anynet+ does not work.	<p>Confirm that the device is an Anynet+ device. The Anynet+ system supports Anynet+ devices only.</p> <p>Check if the power cord of the Anynet+ device is properly connected.</p> <p>Check the cable connections of the Anynet+ device.</p> <p>Go to Anynet+ (HDMI-CEC) ((MENU/123) &gt; MENU &gt; System &gt; Anynet+ (HDMI-CEC)) and see if Anynet+ (HDMI-CEC) has been set to On.</p> <p>Check whether the TV remote control is in TV mode.</p> <p>Check whether the remote control is Anynet+ compatible.</p> <p>Anynet+ may not function when some other functions are active, including Channel Search, Smart Hub, Initial Setup, etc.</p> <p>If you have disconnected and then reconnected the HDMI cable, scan for devices again or turn your TV off and on.</p>
I want to start Anynet+.	<p>Check if the Anynet+ device is properly connected to the TV, and then select the Anynet+ (HDMI-CEC) ((MENU/123) &gt; MENU &gt; System &gt; Anynet+ (HDMI-CEC)) menu to see if Anynet+ (HDMI-CEC) is set to On.</p>
I want to exit Anynet+.	<p>Select View TV from the Anynet+ menu.</p> <p>Select a non-Anynet+ device from the Source list.</p>
The message "Connecting to Anynet+ device..." or "Disconnecting from Anynet+ device" appears on the screen.	<p>You cannot use the remote control when you are configuring Anynet+ or switching to a viewing mode. Use the remote control after the TV has completed the Anynet+ configuration or has switched to a viewing mode.</p>
The Anynet+ device won't play.	<p>You cannot use the play function when Setup is in progress.</p>
The connected device is not displayed.	<p>Check whether the device supports Anynet+.</p> <p>Check whether the HDMI cable is properly connected.</p> <p>Go to Anynet+ (HDMI-CEC) ((MENU/123) &gt; MENU &gt; System &gt; Anynet+ (HDMI-CEC)) and see if Anynet+ (HDMI-CEC) has been set to On.</p> <p>Scan for Anynet+ devices again.</p> <p>Anynet+ devices must be connected to the TV using an HDMI cable. Make sure the device is connected to your TV with an HDMI cable. Some HDMI cables may not support Anynet+.</p> <p>If the connection is terminated because there has been a power failure or the HDMI cable has been disconnected, please scan for the device again.</p>
The TV audio is not being played through the receiver.	<p>Connect an optical cable to the TV and the receiver.</p> <p>ARC enables the TV to output digital sound via the HDMI (ARC) port.</p> <p>However, ARC is only available when the TV is connected to an audio receiver that supports ARC.</p>

# I Have Trouble Launching/Using Apps

The problem	Try this!
I launched an app, but it's in English. How can I change the language?	Languages supported by the app may be different from the user interface language. The ability to change the language depends on the service provider.
My application is not working.	Check with the service provider. Refer to the Help section on the application service provider's website.

# My File Won't Play

The problem	Try this!
Some files can't be played.	This problem may occur with high-bitrate files. Most files can be played back, but you might experience problems with high-bitrate files.

# I Want to Reset the TV

Reset	Path	Description
Reset Settings	(MENU/123) > MENU > Support > Self Diagnosis > Reset	Reset Picture, Sound, Channel, Smart Hub, and all other settings, except for the network settings, to the default settings.
Resetting Smart Hub	(MENU/123) > MENU > Smart Hub > Reset Smart Hub	Resets all Smart Hub settings to their factory defaults and deletes all information related to Samsung accounts, linked service accounts, Smart Hub service agreements, and Smart Hub applications.

# Other Issues

The problem	Try this!
The TV is hot.	Watching TV for an extended period of time causes the panel to generate heat. The heat from the panel is dissipated through internal vents running along the top of the TV. The bottom, however, may feel hot to the touch after extended use. Children watching TV need constant adult supervision to prevent them from touching the TV. This heat, however, is not a defect and does not affect the TV's functionality.
The picture won't display in full screen.	HD channels will have black bars on either side of the screen when displaying upscaled SD (4:3) content. Black bars will appear at the top and bottom of the screen when you watch movies that have aspect ratios different from your TV. Adjust the picture size options on your external device or set the TV to full screen.
The "Mode Not Supported" message appears.	The output resolution of the attached device is not supported by the TV. Check the TV's supported resolutions and adjust the external device's output resolution accordingly.
The Captions item in the TV menu is grayed out.	You cannot select the Caption menu if you have selected a source connected to the TV via HDMI or Component. To view captions, turn on the external device's caption function.
The TV smells of plastic.	This smell is normal and will dissipate over time.
The Signal Information option under Self Diagnosis isn't activated.	Verify that the current channel is a digital channel. The Signal Information is only available for digital channels.
The TV is tilted to the side.	Remove the base stand from the TV and reassemble it.

The problem	Try this!
The Broadcasting option has been deactivated.	Broadcasting is only available when the Source is set to TV. The Broadcasting menu cannot be accessed while you watch TV using a cable box or satellite receiver. The Broadcasting menu cannot be accessed while a recording is in progress or the Timeshift function is running.
The settings are lost after 5 minutes or every time the TV is turned off.	If the Use Mode is set to Store Demo, the TV's audio and video settings are automatically reset every 5 minutes. Change the Use Mode ((MENU/123) > MENU > Support > Use Mode) to Home Use.
There is an intermittent loss of audio or video.	Check the cable connections and reconnect them. Loss of audio or video can be caused by using overly rigid or thick cables. Make sure the cables are flexible enough for long term use. If you are mounting the TV to a wall, we recommend using cables with 90-degree connectors.
There are small particles on the TV's bezel.	This is part of the product's design and is not a defect.
The PIP menu is not available.	PIP functionality is only available when you are viewing video from an HDMI or Component source on the main screen.
A POP (TV's internal banner ad) appears on the screen.	Change the Use Mode ((MENU/123) > MENU > Support > Use Mode) to Home Use.
The TV is making a popping noise.	The expansion and contraction of the TV's outer casing may cause a popping noise. This does not indicate a product malfunction. The TV is safe to use.
The TV is making a humming noise.	Your TV utilizes high-speed switching circuits and high levels of electrical current. Depending on the TV's brightness level, the TV may seem slightly noisier than a conventional TV. Your TV has undergone strict quality control procedures that meet our demanding performance and reliability requirements. Some noise coming from the TV is considered normal and is not an acceptable cause for an exchange or refund.

# Before Using the Recording and Timeshift Functions

## Before using the recording and schedule recording functions

 Recording is not supported in the U.S.A and Canada.

- To set up a Schedule Recording, you must first set the TV's clock. Set the Clock ((MENU/123) > MENU > System > Time > Clock).
- You can set up a maximum total of 30 Schedule Viewing and Schedule Recording entries.
- Recordings are DRM-protected and therefore cannot be played back on a computer or on a different TV. In addition, these files cannot be played back on your TV if its video circuit has been replaced.
- A USB hard drive with a speed of 5,400rpm or above is recommended. However, RAID-type USB hard drives are not supported.
- USB memory sticks are not supported.
- The total recording capacity may differ with the amount of available hard drive space and the recording quality level.
- Schedule Recording requires at least 100MB of free space on the USB storage device. Recording will stop if the available storage space falls below 50MB while recording is in progress.
- If the available storage space falls below 500MB while both the Schedule Recording and Timeshift functions are in progress, only the recording will stop.
- The maximum recording time is 720 minutes.
- Videos are is played according to the TV settings.
- If the input signal is changed while recording is in progress, the screen will go blank until the change is made. In this case, recording will resume, but ● will not be available.
- When using the Record or Schedule Recording function, the actual recording may start a second or two later than the specified time.
- If the Schedule Recording function is operating while a recording is being made on an HDMI-CEC external device, the priority is given to the Schedule Recording.
- Connecting a recording device to the TV automatically deletes abnormally saved recording files.
- If the Off Timer or Auto Power Off has been set, the TV will override these settings, continue to record, and turn off after the recording has ended.

## Before using the timeshift function

 Timeshift is not supported in the U.S.A and Canada.





- A USB hard drive with a speed of 5,400 rpm or above is recommended. However, RAID-type USB hard drives are not supported.
- USB memory sticks or flash drives are not supported.
- The total recording capacity may differ with the amount of available hard drive space and the recording quality level.
- If the available storage space falls below 500MB while both the Schedule Recording and Timeshift functions are in progress, only the recording will stop.
- The maximum amount of time available for the Timeshift function is 90 minutes.
- The Timeshift function is not available for locked channels.
- Time-shifted videos are is played according to the TV settings.
- The Timeshift function may be terminated automatically once it reaches its maximum capacity.
- The Timeshift function requires at least 1.5GB of free space available on the USB storage device.

# Read Before Using 3D Mode

 This function is only supported for the 7100 to 8500 and 710D to 850D series models.

## 3D precautions

### Warning

- When viewing a 3D video under a fluorescent lamp (50 Hz - 60 Hz) or 3-wavelength lamp, you may notice a small amount of screen flickering.
  -  If this symptom occurs, dim or turn off the light.
- Switching the input mode while watching a 3D movie may disable the 3D function on the TV.
  -  If this symptom occurs, the 3D glasses may automatically turn off.
- If you lie on your side while watching TV with 3D active glasses, the picture may appear dark or may not be visible. The actual 3D effect may be experienced differently depending on the viewer. The 3D effect may not be visible if the visual ability of your left eye differs greatly from the visual ability of your right eye.
- If a part of the 3D glasses or lenses is defective or damaged, it cannot be repaired and the glasses should be replaced. If the glasses stop working within the warranty period, the glasses can be repaired or replaced for free. If the glasses have been damaged due to the fault of the customer or the warranty period has expired, a new pair of glasses will have to be purchased.
- If the eye sight in one of your eyes differs greatly from the eye sight in the other eye, you may perceive 3D effects to a lesser degree than other persons or may not perceive 3D effects at all.
- Ensure you are within the working distance of the glasses when you view a 3D video.
  -  The images may not be viewable in 3D if you move outside of the working distance for 3 seconds.
  -  If the 3D glasses are moved outside of their working distance, the signal from the TV will disconnect and the glasses' 3D function will turn off after several seconds. When this happens, the red LED will turn on for 3 seconds.
- The 3D glasses may not work properly due to interference from other 3D products or electronic devices that operate on the 2.4 GHz frequency such as a microwave oven or Internet AP. If the 3D function malfunctions due to interference, please move all other electronic or wireless communication devices as far away from the glasses and the TV as possible.
- The vividness of the image may appear degraded if you view 3D video in a place that is exposed to direct sunlight or illumination.
- The 3D glasses may malfunction if there is an electric field or metallic object such as a steel plate nearby. Keep the glasses as far away as possible from electric fields and metallic objects.
- With SSG-3570 model glasses, the glasses may power off if you remain stationary while viewing 3D video for an extended period of time.
- With SSG-3570 model glasses, if the 3D glasses do not function immediately after you put them on when the TV is in 3D mode, take them off and then put them back on.

**⚠ Caution**

**IMPORTANT HEALTH AND SAFETY INFORMATION FOR 3D VIEWING. READ THE FOLLOWING CAUTIONS BEFORE YOU OR YOUR CHILD USE THE 3D FUNCTION.**

- Adults should frequently check on children who are using the 3D function. If there are any complaints of tired eyes, headaches, dizziness, or nausea, stop the child from viewing the 3D TV and ensure that they rest.
- Do not use the 3D glasses for other purposes such as general wear, sunglasses, protective goggles, etc.
- Some viewers may experience discomfort such as dizziness, nausea, and headaches while viewing 3D TV. If you experience any of these symptoms, stop viewing the 3D TV, remove the 3D glasses, and rest for awhile.
- Watching 3D pictures for an extended period of time may cause eye strain. If you experience any eye strain, stop viewing the 3D TV, remove the 3D glasses, and rest for awhile.
- Do not use the 3D function or 3D glasses while walking or moving around. Using the 3D function or 3D Active Glasses while moving around may result in injury from running into objects, tripping, and/or falling.
- Do not sleep with the 3D glasses on. You can damage or break the temples.
- The temples on your 3D glasses are not foldable. Forcing the temples to fold will damage the 3D glasses.
- With SSG-3570 model glasses, do not shake your 3D glasses repeatedly. Shaking the glasses will power them on and can cause the battery to discharge faster than it would normally.
- With SSG-5100GB and SSG-5150GB models glasses, there is a danger of explosion if you replace the battery with the wrong type of battery.
- With SSG-5100GB and SSG-5150GB models glasses, make sure to replace the battery with the same type of battery.

## Safety precautions

The following safety instructions are provided to ensure your personal safety and prevent property damage. Please read the following to ensure the proper use of the product.

- Do not place the product in a location exposed to direct sunlight, heat, fire, or water. Exposure may result in a product malfunction or fire.
- Do not apply force to the lenses of the 3D glasses. Do not drop or bend the glasses. Applying force, dropping, or bending may result in a 3D glasses malfunction.
- Keep the components of the 3D glasses out of reach of children. Especially, ensure children do not swallow any of the components. If your child swallows a component, consult your doctor immediately.
- When cleaning the glasses, do not spray water or cleaner directly onto its surface. Spraying water or cleaner directly onto the glasses may result in fire or electric shock, damage to the glasses's surface, or cause the indicator labels on the glasses's surface to come loose.
- Do not apply chemicals containing alcohol, solvent, or surfactant such as wax, benzene, thinner, pesticide, air freshener, lubricant, or cleaner to the glasses. These chemicals may cause the glasses's exterior to discolor or crack, or the labels or instructions to be removed. Use only a soft cloth such as superfine fibers or cotton flannels to clean the glasses as the surface and the lenses easily crack. Because the glasses can be easily scratched by foreign substances, make sure to dust off the cloth before using.
- Do not disassemble, or attempt to repair or modify your 3D active glasses by yourself.
- Be careful not to let the temple ends of the 3D active glasses harm your eye.
- Do not sleep with the 3D glasses on. You can break the arms.
- Use your hands to put on or remove the 3D glasses.
- For SSG-5100 and SSG-5150 model glasses, use only the specified standard batteries. When replacing the battery, insert the battery so that its polarity (+, -) is correct. Failing to do so may damage the battery or result in fire, personal injury or environmental damage caused by liquid leaking from the battery.
- For SSG-5100 and SSG-5150 model glasses, keep used batteries out of the reach of children so that they do not accidentally swallow it. If your child swallows a battery, consult your doctor immediately.
- Swallowing the cylindrical (button type) battery can cause serious damage to your internal organs. If this happens, contact a doctor immediately.

# Supported Resolutions for 3D Modes

 These specifications apply to the 16:9 display ratio only.

## HDMI

- 3D Mode:  (L/R),  (T/B)

Resolution	Frequency (Hz)
1280 x 720p	50 / 60
1920 x 1080i	50 / 60
1920 x 1080p	24 / 25 / 30 / 50 / 60
3840 x 2160p	24 / 25 / 30 / 50 / 60

## Component

Resolution	Frequency (Hz)
1280 x 720p	59.94 / 60
1920 x 1080i	59.94 / 60
1920 x 1080p	23.98 / 24 / 29.97 / 30 / 59.94 / 60

## Digital channel

Resolution	Frequency (Hz)
1280 x 720p	59.94 / 60
1920 x 1080i	59.94 / 60

## Videos/Photos

Refer to "Read Before Playing Photo, Video, or Music Files."

## Computer via HDMI cable

The optimal resolution for computers connected to the TV via an HDMI cable is 1920 x 1080. If you select another resolution, the TV may not display 3D images correctly and may not be able to display the computer video in full screen.

# Supported Resolutions for each of UHD Input Signals

- Resolution: 3840 x 2160p, 4096 x 2160p

 The HDMI connection with **HDMI UHD Color** set to **Off** supports up to UHD 50P/60P 4:2:0 input signals, while the HDMI connection with **HDMI UHD Color** set to **On** supports up to UHD 50P/60P 4:4:4 and 4:2:2 input signals.

## If HDMI UHD Color is set to Off



Frame rate (fps)	Color Depth / Chroma Sampling	RGB 4:4:4	YCbCr 4:4:4	YCbCr 4:2:2	YCbCr 4:2:0
50 / 60	8 bit	-	-	-	0

## If HDMI UHD Color is set to On

Frame rate (fps)	Color Depth / Chroma Sampling	RGB 4:4:4	YCbCr 4:4:4	YCbCr 4:2:2	YCbCr 4:2:0
50 / 60	8 bit	0	0	0	0
	10 bit	-	-	0	0
	12 bit	-	-	0	0

 For the 6 series models or lower, make sure to connect to the HDMI IN (STB/DVI) port of the TV.

## S Recommendation disclaimer

-  Some of the features recommended by S Recommendation may not be available on all models.
-  S Recommendation is only available for the models made for the U.S.A.

## S Recommendation with voice interaction

For recommendations given in response to common speech commands:

Voice Interaction is limited to the official language of the country of purchase. Performance may vary based on content availability, the clarity and volume of your voice, and ambient noise levels. Strong regional accents may not be recognized.

Certain Samsung Smart TV features may not be available if you do not give your expressed consent to the collection and use of personal information.

Certain features within S Recommendation require Internet access and may not be available based on service provider, language, dialect, and region.

Your remote control may differ from the images shown in this manual.

## S Recommendation

For content recommendations given to fit your TV viewing preferences:

Certain Samsung Smart TV features may not be available if you do not give your expressed consent to the collection and use of personal information.

Certain features within S Recommendation require Internet access and may not be available based on service provider, language, dialect, and region.

Your remote control may differ from the images shown in this manual.

# Read Before Using Voice, Motion, or Face Recognition

## Precautions for voice, motion, and face recognition

### Face recognition

- This product saves thumbnail images of users' faces for use during the Face Recognition Login.
- Logging into the Smart Hub via Face Recognition may be less secure than logging in using an ID and password.

### Using the TV camera

- Under some circumstances and under certain legal conditions, the use/misuse of the TV camera may result in illegal actions. There may be obligations under local privacy laws regarding the protection of individuals concerning personal data and on the free movement of such data, and possibly other laws including criminal laws regulating camera surveillance both in the workplace and elsewhere.
- By using the TV camera, users agree that it will not be used (i) in locations where cameras are generally prohibited (such as bathrooms, locker rooms or changing rooms), (ii) in any manner that will result in an invasion of a person's privacy, or (iii) in violation of any applicable laws, regulations or statutes.
- When you are no longer using the camera, close the lens cover of the camera or retract it. This prevents any inadvertent or unintentional camera operation.

### Motion Control

- **Motion Control** functions through the camera connected to the TV. For **Motion Control** to work, you must be within the camera's recognition range. The camera's recognition range differs with the ambient light level and other factors.
- Run the **Motion Control Environment Test** before using **Motion Control** to determine the camera's recognition range.
- You may experience physical fatigue when using **Motion Control** for extended periods.

## Voice Recognition

- **Voice Recognition** is not available in all languages, dialects, or regions. Its performance differs with the language chosen, voice volume, and ambient noise levels in the surrounding area.
- Voice Text Input requires that you agree to any third-party app's voice privacy policy.
- Voice Text Input lets you enter text using voice commands instead of a mouse, keyboard, or remote control. This feature is particularly useful for searching, browsing the web, and using applications.
- You must agree to the following privacy notices before using Interactive Voice Recognition:
  - Voice Recognition Privacy Notice, Nuance Privacy Notice

## Requirements for using voice, motion, or face recognition

### Requirements for using voice recognition

- The voice recognition rate differs with the volume/tone, pronunciation, and ambient sound environment (TV sound and ambient noise).

## Requirements for Using Motion Recognition

- Be sure to use Motion Control within the recommended distance of between 4.9 ft (1.5 m) and 11.4 ft (3.5 m). The actual recognition range may differ with the camera angle and other factors.
- You must be located within a range of the camera lens, because Motion Control relies on the TV's built-in camera. Adjust the camera's angle by pressing the front of the camera down and forwards or up and back. Do not point the camera directly at the sun or any other light source or obstruct its view.
- For the camera to recognize movement, you must stand out from the background.
- The appropriate ambient brightness is 50 to 500 lux. (A bathroom typically has 100 Lux, a living room 400 Lux.)
- Avoid direct sunlight when using Motion Control.
- Run the **Motion Control Environment Test** to assess the camera's recognition range before using Motion Control.

## Requirements for using Face Recognition

- Be sure to use Face Recognition within the recommended distance of between 4.9 ft (1.5 m) and 13.1 ft (4 m). The actual recognition range may differ with the camera angle and other factors.
- The appropriate ambient brightness is 50 to 500 lux. (A bathroom typically has 100 Lux, a living room 400 Lux.)
- Face Recognition can recognize up to 5 different users at a time.
- The TV may have difficulty recognizing twins and people with similar faces as two different individuals.
- Note the following when using Face Recognition:
  - Do not cover your face with a hat, a pair of sunglasses, or your hair.
  - Your entire face must be visible to the camera. Avoid shadows over your face. Shadows prevent the camera from recognizing faces accurately.
  - Keep your expression as neutral as possible. In addition, keep your mouth closed and as neutral as possible.
  - When you log into your Samsung account, your facial expression must be the same as the facial expression you had when you registered.

## Read Before Using Apps

- Due to the product characteristics featured on Samsung Smart Hub, as well as limitations in available content, certain features, applications, and services may not be available on all devices or in all territories. Some Smart Hub features may also require additional peripheral devices or membership fees. Visit <http://www.samsung.com> for more information on specific device information and content availability. Services and content availability are subject to change without prior notice.
- Samsung Electronics takes no legal responsibility whatsoever for any interruption of app services caused by the service provider for any reason.
- Application services may be provided in English only and available content may differ with the geographical area.
- For more information about applications, visit the applicable service provider's website.
- An unstable Internet connection may cause delays or interruptions. In addition, applications may terminate automatically depending on the network environment. If this occurs, check your Internet connection and try again.
- Application services and updates may become unavailable.
- Application content is subject to change by the service provider without prior notice.
- Specific services may differ with the version of the application installed on the TV.
- An application's functionality may change in future versions of the application. If this occurs, run the application's tutorial or visit the service provider's website.
- Depending on the service provider's policies, certain applications may not support multitasking.

## Read Before Using the Web Browser

- Select **Web Browser**. The browsing screen may differ from the one on your computer.
- The web browser is not compatible with Java applications.
- You can download the supported types of files, such as videos, mp3 files, and images, but you cannot download files that are not supported by the TV. If you attempt to download an unsupported file, you will receive an error message instead.
- The web browser may not be able to access certain websites.
- The TV does not support playback of flash videos.

- E-commerce for online purchases is not supported.
- With websites that have scrollable windows, scrolling a window can result in corrupted characters.
- ActiveX is not supported.
- Certain options are not accessible in Link Browsing mode. (Switch to Pointer Browsing to activate those options.)
- Only a limited number of fonts are supported. Certain symbols and characters may not be displayed properly.
- The response to remote commands and the resulting on-screen display may be delayed while a webpage is loading.
- Loading a webpage may be delayed or suspended completely with certain operating systems.
- The copy and paste operations are not supported.
- When composing an email or a simple message, certain functions such as the font size and color selection may not be available.
- There is a limit to the number of bookmarks and the size of the log file that can be saved.
- The number of windows that can be opened concurrently differs with the search conditions and the TV model.
- The web browsing speed will differ with the network environment.
- Embedded videos can play at the same time the PIP (picture-in-picture) function is operating.
- The web browser supports .mp3 audio files only.
- If the Clock ((MENU/123) > MENU > System > Time > Clock) has not been set, the browsing history will not be saved.
- The browsing history is saved from latest to oldest, with the oldest entries being overwritten first.
- Depending on the types of video/audio codecs supported, it might not be possible to play certain video and audio files while playing Flash content.
- Video sources from PC-optimized streaming service providers may not play properly on our proprietary web browser.
- Using the on-screen QWERTY keyboard automatically disables PIP (except when you are entering a URL).

# Read Before Playing Photo, Video, or Music Files

## Limitations on use of photo, video, and music files

- The TV supports MSC (Mass Storage Class) USB devices only. MSC is a class designation for mass storage devices. Types of MSC devices include external hard drives, flash card readers, and digital cameras. (USB hubs are not supported.) These kinds of devices must be connected directly to the TV's USB port. The TV may not be able to recognize a USB device or read the files on the device if it is connected to the TV via a USB extension cable. Do not disconnect USB devices while they are transferring files.
- When connecting an external hard drive, use the USB (HDD) port. We recommend that you use an external hard drive with its own power adapter.
- Certain digital cameras and audio devices may not be compatible with the TV.
- If there are multiple USB devices connected to the TV, the TV might not be able to recognize some or all the devices. USB devices that use high-power input should be connect to the USB [5V, 1A] port.
- The TV supports the FAT, exFAT, and NTFS file systems.
- After sorting files in the Folder view mode, the TV can display up to 1000 files per folder. If the USB device contains more than 8,000 files and folders, however, some files and folders might not be accessible.
- The PTP (pier to pier) connection mode is available only for digital cameras. If you connect a smartphone or tablet to the TV using PTP mode, the TV will not recognize it.
- Be sure to connect USB or external hard drives that support USB 3.0, to the USB 3.0 port.
- Certain files, depending on how they are encoded, may not play on the TV.
- Certain files are not supported on all models.

## Supported external subtitles

Name	Format
MPEG-4 Timed text	.ttxt
SAMI	.smi
SubRip	.srt
SubViewer	.sub
Micro DVD	.sub or .txt
SubStation Alpha	.ssa
Advanced SubStation Alpha	.ass
Powerdivx	.psb
SMPTE-TT Text	.xml

## Supported internal subtitles

Name	Container
Xsub	AVI
SubStation Alpha	MKV
Advanced SubStation Alpha	MKV
SubRip	MKV
VobSub	MKV
MPEG-4 Timed text	MP4
TTML in smooth streaming	MP4
SMPTE-TT Text	MP4
SMPTE-TT PNG	MP4

## Supported image formats and resolutions

File extension	Format	Resolution
*.jpg *.jpeg	JPEG	15360x8640
*.png	PNG	4096x4096
*.bmp	BMP	4096x4096
*.mpo	MPO	15360x8640

## Supported music formats and codecs

File extension	Format	Codec	Note
*.mp3	MPEG	MPEG1 Audio Layer 3	
*.m4a *.mpa *.aac	MPEG4	AAC	
*.flac	FLAC	FLAC	Supports up to 2 channels
*.ogg	OGG	Vorbis	Supports up to 2 channels
*.wma	WMA	WMA	Supports up to 10 Pro 5.1 channels. WMA lossless audio is not supported. Supports up to the M2 profile.
*.wav	wav	wav	
*.mid *.midi	midi	midi	Supports type 0 and type 1. Seek is not supported. Supports USB device only.
*.ape	ape	ape	
*.aif *.aiff	AIFF	AIFF	
*.m4a	ALAC	ALAC	

## Supported video codecs

File format	Container	Video codecs	Resolution	Frame rate (fps)	Bitrate (Mbps)	Audio codecs		
*.avi *.mkv *.asf *.wmv *.mp4 *.mov *.3gp *.vro *.mpg *.mpeg *.ts *.tp *.trp *.mov *.flv *.vob *.svi *.m2ts *.mts *.divx	AVI MKV ASF MP4 3GP MOV FLV VRO VOB PS TS SVAF	H.264 BP/MP/HP	4096x2160	4096X2160: 24 3840X2160: 30	40	Dolby Digital LPCM ADPCM(IMA, MS) AAC HE-AAC WMA Dolby Digital Plus MPEG(MP3) DTS(Core, LBR) G.711(A-Law, μ-Law)		
		HEVC (H.265 - Main, Main10, Main4:2:2 10)		60	80			
		Motion JPEG		30	80			
				MVC	1920x1080		60	20
				DivX 3.11 / 4 / 5 / 6				
				MPEG4 SP/ASP				
				Window Media Video v9(VC1)				
				MPEG2				
				MPEG1				
				Microsoft MPEG-4 v1, v2, v3				
				Window Media Video v7(WMV1) ,v8(WMV2)				
				H.263 Sorrenson				
				VP6				
*.webm	WebM	VP8	1920x1080	90	Vorbis			
		VP9	4096x2160	4096X2160: 24 3840X2160: 30				

## Other restrictions

- Codecs may not function properly if there is a problem with the content.
- Video content does not play or does not play correctly if there is an error in the content or container.
- Sound or video may not work if they have standard bit rates/frame rates above the TV's compatibility ratings.
- If the Index Table is has an error, the Seek (Jump) function will not work.
- When playing video over a network connection, the video may not play smoothly because of data transmission speeds.
- Some USB/digital camera devices may not be compatible with the TV.
- HEVC codec is only available in MKV /MP4 / TS containers.

## Video decoders

- H.264 FHD is supported up to Level 4.1. (does not support FMO/ASO/RS)
- H.264 UHD is supported up to Level 5.1.
- HEVC FHD is supported up to Level 4.1, and HEVC UHD is supported up to Level 5.1.
- VC1 AP L4 is not supported.
- All video codecs excluding WMV v7, v8, MSMPEG4 v3, MVC, and VP6:  
**Below 1280x720:** 60 frame max  
**Above 1280x720:** 30 frame max
- GMC 2 or above is not supported.
- Supports SVAF Top/Bottom, Side by Side, and Left/Right view sequence type (2ES) only.
- Supports BD MVC specs only.

## Audio decoders

- WMA 10 Pro supports up to 5.1 channels. Supports up to the M2 profile. WMA lossless audio is not supported.
- QCELP and AMR NB/WB are not supported.
- Vorbis is supported for up to 5.1 channels.
- Dolby Digital Plus is supported for up to 5.1 channels.
- The DTS LBR codec is only available for MKV / MP4 /TS containers.
- The supported sample rates are 8, 11.025, 12, 16, 22.05, 24, 32, 44.1, and 48 KHz, and differ by the codec.

# Read After Installing the TV

## Picture sizes and input signals

The Picture Size setting is applied to the current source. The applied Picture Size will remain in effect whenever you select that source unless you change it.

Input signal	Picture size
Component	16:9, Zoom, Custom, 4:3
Component (1080i, 1080p)	16:9, Zoom, Custom, 4:3
Digital channel (720p, 1080i, 1080p)	16:9, Zoom, Custom, 4:3
Digital channel (3840 x 2160p)	16:9, Zoom, Custom
Digital channel (4096 x 2160p)	16:9, Zoom, Custom
HDMI (720p)	16:9, Zoom, Custom, 4:3
HDMI (1080i, 1080p)	16:9, Zoom, Custom, 4:3
HDMI (3840 x 2160p)	16:9, Zoom, Custom
HDMI (4096 x 2160p)	16:9, Zoom, Custom

## Installing an anti-theft lock

An anti-theft lock is a physical device that can be used to protect the TV against theft. Look for the lock slot on the back of the TV. The slot has a  icon next to it. To use the lock, wrap the lock cable around an object that is too heavy to carry and then thread it through the TV's lock slot. The lock is sold separately. The method of using an anti-theft lock may differ for each TV model. Refer to the lock's user manual for more information.

 This function is not available on certain models in specific geographical areas.

# Read before setting up a wireless Internet connection

## Precautions for wireless Internet

- This TV supports the IEEE 802.11 a /b /g /n /ac communication protocols. Samsung recommends using IEEE 802.11n. Video files stored on a device connected to the TV via a Home Network may not play back smoothly.
- To use wireless Internet, the TV must be connected to a wireless router or modem. If the wireless router supports DHCP, the TV can use a DHCP or static IP address to connect to the wireless network.
- Select a channel that is not currently in use for the wireless router. If the channel set for the wireless router is currently being used by another device, the result is usually interference and/or a communications failure.
- Most wireless networks have an optional security system. To enable a wireless network's security system, you need to create a password using characters and numbers. This password is then needed to connect to a security-enabled AP.

## Wireless security protocols

The TV only supports the following wireless network security protocols. The TV cannot connect to non-certified wireless routers.

- Authentication Modes: WEP, WPAPSK, WPA2PSK
- Encryption Types: WEP, TKIP, AES

In compliance with the newest Wi-Fi certification specifications, Samsung TVs do not support WEP or TKIP security encryption in networks running in the 802.11n mode. If the wireless router supports WPS (Wi-Fi Protected Setup), you can connect the TV to your network using PBC (Push Button Configuration) or a PIN (Personal Identification Number). WPS automatically configures the SSID and WPA key settings.

# Read Before Connecting a Computer (Supported Resolutions)

When you connect your TV to a computer, set the computer's video card to one of the standard resolutions listed in the tables below or on the next page. The TV will automatically adjust to the resolution you choose. Note that the optimal and recommended resolution is 3840 x 2160 at 60 Hz. Choosing a resolution not included in the tables can result in a blank screen or just the power indicator turning on. Refer to the user manual of your graphics card for compatible resolutions.

## IBM

Resolution (Dots x lines)	Display format	Horizontal frequency (KHz)	Vertical frequency (Hz)	Clock frequency (MHz)	Polarity (horizontal / vertical)
720 x 400	70 Hz	31,469	70,087	28,322	- / +

## MAC

Resolution (Dots x lines)	Display format	Horizontal frequency (KHz)	Vertical frequency (Hz)	Clock frequency (MHz)	Polarity (horizontal / vertical)
640 x 480	67 Hz	35,000	66,667	30,240	- / -
832 x 624	75 Hz	49,726	74,551	57,284	- / -
1152 x 870	75 Hz	68,681	75,062	100,000	- / -

# VESA DMT

Resolution (Dots x lines)	Display format	Horizontal frequency (KHz)	Vertical frequency (Hz)	Clock frequency (MHz)	Polarity (horizontal / vertical)
640 x 480	60 Hz	31,469	59,940	25,175	- / -
640 x 480	72 Hz	37,861	72,809	31,500	- / -
640 x 480	75 Hz	37,500	75,000	31,500	- / -
800 x 600	60 Hz	37,879	60,317	40,000	+ / +
800 x 600	72 Hz	48,077	72,188	50,000	+ / +
800 x 600	75 Hz	46,875	75,000	49,500	+ / +
1024 x 768	60 Hz	48,363	60,004	65,000	- / -
1024 x 768	70 Hz	56,476	70,069	75,000	- / -
1024 x 768	75 Hz	60,023	75,029	78,750	+ / +
1152 x 864	75 Hz	67,500	75,000	108,000	+ / +
1280 x 720	60 Hz	45,000	60,000	74,250	+ / +
1280 x 800	60 Hz	49,702	59,810	83,500	- / +
1280 x 1024	60 Hz	63,981	60,020	108,000	+ / +
1280 x 1024	75 Hz	79,976	75,025	135,000	+ / +
1366 x 768	60 Hz	47,712	59,790	85,500	+ / +
1440 x 900	60 Hz	55,935	59,887	106,500	- / +
1600 x 900RB	60 Hz	60,000	60,000	108,000	+ / +
1680 x 1050	60 Hz	65,290	59,954	146,250	- / +
1920 x 1080	60 Hz	67,500	60,000	148,500	+ / +

# Supported Resolutions for Video Signals

## CEA-861

Resolution (Dots x lines)	Display format	Horizontal frequency (KHz)	Vertical frequency (Hz)	Clock frequency (MHz)	Polarity (horizontal / vertical)
720(1440) x 576i	50 Hz	15.625	50,000	27,000	- / -
720(1440) x 480i	60 Hz	15.734	59,940	27,000	- / -
720 x 576	50 Hz	31.250	50,000	27,000	- / -
720 x 480	60 Hz	31.469	59,940	27,000	- / -
1280 x 720	50 Hz	37,500	50,000	74,250	+ / +
1280 x 720	60 Hz	45,000	60,000	74,250	+ / +
1920 x 1080i	50 Hz	28,125	50,000	74,250	+ / +
1920 x 1080i	60 Hz	33,750	60,000	74,250	+ / +
1920 x 1080	24 Hz	27,000	24,000	74,250	+ / +
1920 x 1080	25 Hz	28,125	25,000	74,250	+ / +
1920 x 1080	30 Hz	33,750	30,000	74,250	+ / +
1920 x 1080	50 Hz	56,250	50,000	148,500	+ / +
1920 x 1080	60 Hz	67,500	60,000	148,500	+ / +
3840 x 2160	24 Hz	54,000	24,000	297,000	+ / +
3840 x 2160	25 Hz	56,250	25,000	297,000	+ / +
3840 x 2160	30 Hz	67,500	30,000	297,000	+ / +
*3840 X 2160	50 Hz	112,500	50,000	594,000	+ / +
*3840 x 2160	60 Hz	135,000	60,000	594,000	+ / +
4096 x 2160	24 Hz	54,000	24,000	297,000	+ / +
4096 x 2160	25 Hz	56,250	25,000	297,000	+ / +
4096 x 2160	30 Hz	67,500	30,000	297,000	+ / +
*4096 X 2160	50 Hz	112,500	50,000	594,000	+ / +
*4096 X 2160	60 Hz	135,000	60,000	594,000	+ / +

 \* : For the 6 series models or lower, make sure to connect to the HDMI IN (STB/DVI) port of the TV.

# Read Before Using Bluetooth Devices

## Restrictions on using Bluetooth

- The Samsung Bluetooth Speaker function is only available for devices supporting TV SoundConnect.
- You can't use Bluetooth devices, TV SoundConnect (MENU > Sound > Speaker Settings > TV SoundConnect), and the Surround feature simultaneously.
- Compatibility issues may occur, depending on the Bluetooth device. (A Mobile exclusive headphone may not be available, depending on the environment.)
- Lip-sync errors may occur.
- The TV and Bluetooth device may disconnect, depending on the distance between them.
- A Bluetooth device may hum or malfunction:
  - When a part of your body is in contact with the receiving/transmitting system of the Bluetooth device or the TV.
  - When the device is subject to electrical variation from obstructions caused by a wall, corner, or office partitioning.
  - When the device is exposed to electrical interference from same frequency-band devices including medical equipment, microwave ovens, and wireless LANs.
- If the problem persists, try connecting the device using the digital optical port or the HDMI (ARC) port.

# License

## **DIVX<sup>®</sup>** **HD**

This DivX Certified<sup>®</sup> device has passed rigorous testing to ensure it plays DivX<sup>®</sup> video.

To play purchased DivX movies, first register your device at [vod.divx.com](http://vod.divx.com). Find your registration code in the DivX VOD section of your device setup menu.

DivX Certified<sup>®</sup> to play DivX<sup>®</sup> video up to HD 1080p, including premium content.

DivX<sup>®</sup>, DivX Certified<sup>®</sup> and associated logos are trademarks of DivX, LLC and are used under license.

Covered by one or more of the following U.S. patents: 7,295,673; 7,460,668; 7,515,710; 7,519,274.

This device supports DivX Plus Streaming<sup>®</sup> for enjoying HD movies and TV shows with advanced features (multi-language subtitles, multiple audio tracks, chapters, smooth FF/RW, etc.) streamed to your device.



For DTS patents, see <http://patents.dts.com>. Manufactured under license from DTS, Inc. DTS, the Symbol, DTS in combination with the Symbol, DTS Premium Sound|5.1, DTS Digital Surround, DTS Express, and DTS Neo2:5 are registered trademarks or trademarks of DTS, Inc. in the United States and/or other countries.

© DTS, Inc. All Rights Reserved.



For DTS patents, see <http://patents.dts.com>. Manufactured under license from DTS Licensing Limited. DTS, the Symbol, & DTS and the Symbol together are registered trademarks, and HEADPHONE:X and the DTS HEADPHONE:X logo are trademarks of DTS, Inc. © DTS, Inc. All Rights Reserved.



Manufactured under license from Dolby Laboratories.

Dolby and the double-D symbol are trademarks of Dolby Laboratories.

## **HDMI**

The terms HDMI and HDMI High-Definition Multimedia Interface, and the HDMI Logo are trademarks or registered trademarks of HDMI Licensing LLC in the United States and other countries.

### **Open Source License Notice**

Open Source used in this product can be found on the following webpage.

(<http://opensource.samsung.com>) Open Source License Notice is written only English.



 This license is may not be supported depending on the country or model.



# Glossary

- **480i / 480p / 720p / 1080i / 1080p**

Generally refers to the number of effective scanning lines that determines the screen's resolution. There are two scanning methods: interlaced and progressive.

- Scanning

Sequential projection of pixels to form images. The higher the number of pixels, the clearer and more vivid the images.

- Progressive

A sequential scanning method that scans every line, one after another.

- Interlaced

A staggered scanning method that scans every other line until the end of the screen and then fills in the remaining lines.

Example) If the number of horizontal scan lines is 480i

Scans 240 lines from start to finish and then scans the remaining 240 lines for a total of 480 lines.

\* General differences between 480i and 480p are as follows:

	480i	480p
Horizontal Frequency	15.75Khz	31.5Khz
FPS	30	60
Lines on Screen	480	480

- **ARC (Audio Return Channel)**

ARC lets the TV output digital sound to an audio device and input digital sound from the same audio device through one HDMI cable. However, ARC is only available through the HDMI (ARC) port and only when the TV is connected to an ARC-enabled AV receiver.

- **DVI (Digital Visual Interface)**

Connecting the TV's DVI connector to a computer's DVI connector via an HDMI-to-DVI cable lets you use the TV as a computer monitor. However, HDMI-to-DVI cables deliver video signals only. You must connect a set of speakers to the computer using a separate cable to hear the computer's audio.

- **HDMI (High Definition Multimedia Interface)**

HDMI is a method of transmitting both video and audio signals via a single cable.

- **Dynamic versus Static IP Addresses**

If the network requires a dynamic IP address, use an ADSL modem or router that supports the Dynamic Host Configuration Protocol (DHCP). Modems and routers that support DHCP automatically provide the IP address, subnet mask, gateway and DNS values the TV needs to access the Internet, so they do not have to be entered manually. Most home networks use a dynamic IP address.

If the network requires a static IP address, enter the IP address, subnet mask, gateway, and DNS values manually when setting up the network connection. To get the IP address, subnet mask, gateway and DNS values, contact your Internet Service Provider (ISP).

If the network requires a static IP address, use an ADSL modem that supports DHCP. ADSL modems that support DHCP also allow static IP addresses.

- **Bluetooth**

Bluetooth is a short-distance wireless communication protocol allowing information exchange between connected Bluetooth compatible mobile phones, laptops, earphones and headphones. It is mostly used for low-power wireless connections within a distance of 32.8 ft.

- **Ethernet**

Ethernet is a LAN (Local Area Network) that uses coaxial cables standardized by the IEEE.

- **Component Connection**

Component connections are mostly used for game consoles and transmit the video signal by splitting it into a luminance signal (Y) and two color signals (Pb and Pr). The connector is marked as [Component IN]\_(Pr, Pb, Y) on the back of the TV. On some devices, it is sometimes marked as Cr, Cb, Y. Cb and Cr are the digital conversions of the Pb and Pr signals.

The connectors are normally color-coded red (R), blue (B), and green (G) and offer the best picture quality possible for an analog connection.