

THANK YOU for purchasing this high-quality product. Register your new refrigerator at www.amana.com. In Canada, register your refrigerator at www.amanacanada.ca.

For future reference, please make a note of your product model and serial numbers. These can be located on the inside wall of the refrigerator compartment.

Model Number _____ Serial Number _____

Table of Contents / Índice/ Table des matières

REFRIGERATOR SAFETY	2	SEGURIDAD DEL REFRIGERADOR	21	SÉCURITÉ DU RÉFRIGÉRATEUR	42
Proper Disposal of Your Old Refrigerator	3	Cómo deshacerse adecuadamente		Mise au rebut appropriée	
INSTALLATION INSTRUCTIONS	3	de su refrigerador viejo	22	de votre vieux réfrigérateur	43
Unpack the Refrigerator	3	INSTRUCCIONES DE INSTALACIÓN	22	INSTRUCTIONS D'INSTALLATION	43
Door Removal, Leveling and Alignment	4	Desempaque el refrigerador	22	Déballage du réfrigérateur	43
Handle Installation and Removal	6	Remoción, nivelación y alineamiento		Retrait, réglage de l'aplomb	
Location Requirements	7	de las puertas	23	et alignement des portes	44
Electrical Requirements	7	Cómo instalar y remover las manijas	25	Installation et démontage des poignées	46
Water Supply Requirements	7	Requisitos de ubicación	26	Exigences d'emplacement	47
Connect Water Supply	8	Requisitos eléctricos	26	Spécifications électriques	47
REFRIGERATOR USE	10	Requisitos del suministro de agua	26	Spécifications de l'alimentation en eau	47
Using the Controls	10	Conexión del suministro de agua	27	Raccordement de la canalisation d'eau	48
Crisper Humidity Control	10	USO DE SU REFRIGERADOR	29	UTILISATION DU RÉFRIGÉRATEUR	50
Water and Ice Dispensers	10	Uso de los controles	29	Utilisation des commandes	50
Ice Maker and Storage Bin	12	Control de humedad del cajón		Réglage de l'humidité dans	
Water Filtration System	12	para verduras	30	le bac à légumes	51
REFRIGERATOR CARE	13	Despachadores de agua y hielo	30	Distributeurs d'eau et de glaçons	51
Cleaning	13	Fábrica de hielo y depósito	31	Machine à glaçons et bac d'entreposage	52
Lights	13	Sistema de filtración de agua	32	Système de filtration de l'eau	53
Vacation and Moving Care	13	CUIDADO DE SU REFRIGERADOR	33	ENTRETIEN DU RÉFRIGÉRATEUR	54
TROUBLESHOOTING	14	Limpieza	33	Nettoyage	54
ACCESSORIES	18	Luces	33	Lampes	54
PERFORMANCE DATA SHEET	19	Cuidado durante		Entretien avant les vacances ou	
WARRANTY	20	las vacaciones y mudanzas	33	lors d'un déménagement	54
		SOLUCIÓN DE PROBLEMAS	34	DÉPANNAGE	56
		ACCESORIOS	39	ACCESSOIRES	61
		HOJA DE DATOS DEL RENDIMIENTO	40	FEUILLE DE DONNÉES SUR LA	
		GARANTÍA	41	PERFORMANCE	62
				GARANTIE	63

REFRIGERATOR SAFETY

Your safety and the safety of others are very important.

We have provided many important safety messages in this manual and on your appliance. Always read and obey all safety messages.



This is the safety alert symbol.

This symbol alerts you to potential hazards that can kill or hurt you and others.

All safety messages will follow the safety alert symbol and either the word "DANGER" or "WARNING."

These words mean:

⚠ DANGER

You can be killed or seriously injured if you don't immediately follow instructions.

⚠ WARNING

You can be killed or seriously injured if you don't follow instructions.

All safety messages will tell you what the potential hazard is, tell you how to reduce the chance of injury, and tell you what can happen if the instructions are not followed.

IMPORTANT SAFETY INSTRUCTIONS

WARNING: To reduce the risk of fire, electric shock, or injury when using your refrigerator, follow these basic precautions:

- Plug into a grounded 3 prong outlet.
- Do not remove ground prong.
- Do not use an adapter.
- Do not use an extension cord.
- Disconnect power before servicing.
- Replace all parts and panels before operating.
- Remove doors from your old refrigerator.
- Connect to a potable water supply only.
- Use nonflammable cleaner.
- Keep flammable materials and vapors, such as gasoline, away from refrigerator.
- Use two or more people to move and install refrigerator.
- Disconnect power before installing ice maker (on ice maker kit ready models only).
- Use a sturdy glass when dispensing ice (on some models).
- Do not hit the refrigerator glass doors (on some models).
- This appliance is not intended for use by persons (including children) with reduced physical, sensory or mental capabilities, or lack of experience and knowledge, unless they have been given supervision or instruction concerning use of the appliance by a person responsible for their safety.
- Children should be supervised to ensure that they do not play with the appliance.

SAVE THESE INSTRUCTIONS

State of California Proposition 65 Warnings:

WARNING: This product contains one or more chemicals known to the State of California to cause cancer.

WARNING: This product contains one or more chemicals known to the State of California to cause birth defects or other reproductive harm.

Proper Disposal of Your Old Refrigerator

⚠️ WARNING

Suffocation Hazard

Remove doors from your old refrigerator.

Failure to do so can result in death or brain damage.

IMPORTANT: Child entrapment and suffocation are not problems of the past. Junked or abandoned refrigerators are still dangerous, even if they will sit for “just a few days.” If you are getting rid of your old refrigerator, please follow these instructions to help prevent accidents.

Before You Throw Away Your Old Refrigerator or Freezer:

- Take off the doors.

- Leave the shelves in place so that children may not easily climb inside.

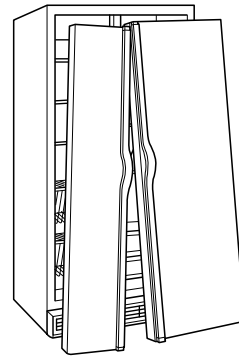

Important information to know about disposal of refrigerants:

Dispose of refrigerator in accordance with Federal and Local regulations. Refrigerants must be evacuated by a licensed, EPA certified refrigerant technician in accordance with established procedures.

INSTALLATION INSTRUCTIONS

Unpack the Refrigerator

⚠️ WARNING

Excessive Weight Hazard

Use two or more people to move and install refrigerator.

Failure to do so can result in back or other injury.

Remove packaging materials. Do not use sharp instruments, rubbing alcohol, flammable fluids, or abrasive cleaners to remove tape or glue. These products can damage the surface of your refrigerator. For more information, see “Refrigerator Safety.”

When Moving Your Refrigerator:

Your refrigerator is heavy. When moving the refrigerator for cleaning or service, be sure to cover the floor with cardboard or hardboard to avoid floor damage. Always pull the refrigerator straight out when moving it. Do not wiggle or “walk” the refrigerator when trying to move it, as floor damage could occur.

Important information to know about glass shelves and covers:

Do not clean glass shelves or covers with warm water when they are cold. Shelves and covers may break if exposed to sudden temperature changes or impact, such as bumping. Tempered glass is designed to shatter into many small, pebble-size pieces. This is normal. Glass shelves and covers are heavy. Use both hands when removing them to avoid dropping.

Door Removal, Leveling and Alignment

Gather the required tools and parts and read all instructions before starting installation. Save these instructions for future reference.

NOTE: Before moving your product into your home, measure the doorway of your home to see whether you need to remove the refrigerator and freezer doors. If door removal is necessary, see the instructions below.

IMPORTANT: Before you begin, turn the refrigerator control OFF or turn cooling off. Unplug refrigerator or disconnect power. Remove food, the ice storage bin (on some models), and any adjustable door or utility bins from doors.

TOOLS NEEDED:

Bubble level; flat-blade screwdriver; 5/16" wrench; 1/4", 1/2", and 5/16" hex-head socket wrenches



⚠ WARNING

Electrical Shock Hazard

Disconnect power before removing doors.
Failure to do so can result in death or electrical shock.

4 Top Left Hinge

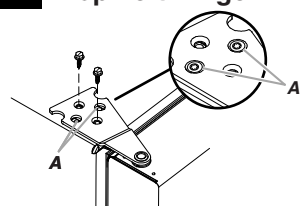

A. Do Not Remove Screws.

5 Door Removal



6 Top Right Hinge

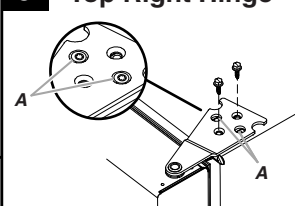

A. Do Not Remove Screws.

3 Wiring Connection

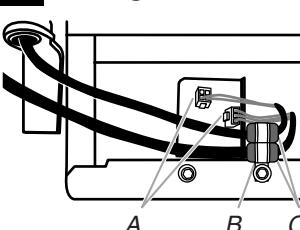

A. Wiring Plugs
 B. Wiring Clip
 C. Grommets

7 Bottom Hinges (Left and Right)

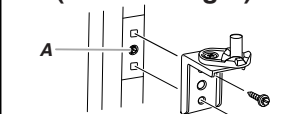

Do Not Remove Screw A (present on some models)

2 Water Dispenser Tubing Connection

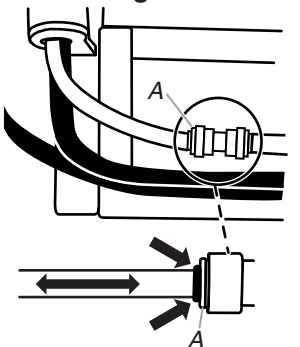

A. Face of Fitting

8 Leveling

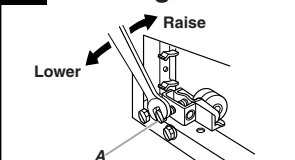

A. Leveling Screw

9 Door Alignment (Bottom Right Hinge)

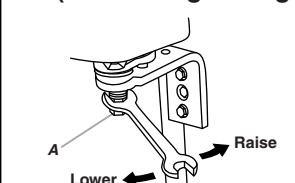

A. Alignment Screw

1 Base Grille

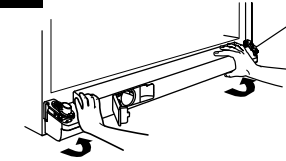

Remove the Doors

⚠ WARNING



Electrical Shock Hazard

Disconnect power before removing doors.

Failure to do so can result in death or electrical shock.

1. Unplug refrigerator or disconnect power.
2. Open both doors (refrigerator and freezer) and the water filter cover door. It is not necessary to remove the water filter itself.
3. Remove the base grille by pulling up on the bottom outside corners. *See Graphic 1.*
4. Disconnect the water dispenser tubing located behind the base grille on the freezer door side. The dispenser tubing runs through the door hinge, and must be disconnected in order to remove the door. *See Graphic 2.*
 - Press blue outer ring against the face of fitting and pull the dispenser tubing free.

NOTE: Keep the water tubing connector attached to the tube that runs underneath the freezer. The door cannot be removed if the connector is still attached to the tube that runs through the door hinge.
5. Disconnect the wiring located behind the base grille on the freezer door side. *See Graphic 3.*
 - Remove the wiring clip using a 1/4" hex-head socket wrench.
 - Disconnect wiring plugs.
6. Close both doors and keep them closed until you are ready to lift them free from the cabinet.
7. Use a 5/16" hex-head socket wrench to remove the top left hinge as shown. *See Graphic 4.*

IMPORTANT: Do not remove either screw A.
8. Lift freezer door straight up off bottom hinge. *See Graphic 5.* The water dispenser tubing and wiring remain attached to the freezer door and pull through the bottom left hinge.

NOTE: This may require two people - one to lift the door and another to feed the water tubing and wiring through the hinge.

IMPORTANT: Rest the door on its side on a soft, clean surface, such as a towel, blanket or piece of cardboard. This will help avoid damaging the door, water tubing and wiring.
9. Remove top right hinge as shown. *See Graphic 6.*

IMPORTANT: Do not remove either screw A.
10. Lift the refrigerator door straight up off bottom hinge.

IMPORTANT: Rest the door on its side on a soft, clean surface, such as a towel, blanket or piece of cardboard. This will help avoid damaging the door.

11. It may not be necessary to remove the bottom hinges to move the refrigerator through a doorway. Both bottom hinges have similar construction.

- If necessary, disassemble the hinges as shown. *See Graphic 7.*

IMPORTANT: To aid in door alignment and closing, there is a shim located between the hinge and the cabinet. When the hinge is removed, the shim may fall out of place. If this occurs, set the shim aside so it can be put back in place when the hinge is reconnected later.

Replace the Doors and Hinges

1. Replace both bottom hinges, if removed. Make sure the shim is between the hinge and cabinet. Tighten screws.
 2. Before replacing the freezer door on the bottom left hinge, feed the wiring with the yellow plug and the water dispenser tubing through the hinge. Assistance may be needed.
- NOTE:** Provide additional support for the doors while the top hinges are being replaced. Do not depend on the door magnets to hold the doors in place while you are working.
3. Align and replace the top left hinge as shown. *See Graphic 4.* Tighten screws.
 4. Reconnect water dispenser tubing and wiring.

IMPORTANT: Do not intertwine the water tubing and wiring bundles when reconnecting them.

 - Push tubing into fitting until it stops and the black mark touches the face of fitting. *See Graphic 2.*
 - Reconnect wiring plugs. Reinstall the wiring clip over the grommets. Tighten screw. *See Graphic 3.*
 5. Replace the refrigerator door by lifting the door onto the bottom right hinge.
 6. Align and replace the top right hinge as shown. *See Graphic 6.* Tighten screws.
 7. Replace the ice storage bin (on some models) and any adjustable door or utility bins.

⚠ WARNING



Electrical Shock Hazard

Plug into a grounded 3 prong outlet.

Do not remove ground prong.

Do not use an adapter.

Do not use an extension cord.

Failure to follow these instructions can result in death, fire, or electrical shock.

8. Plug into a grounded 3 prong outlet.

Leveling and Door Closing

Your refrigerator has two front adjustable rollers — one on the right and one on the left. If your refrigerator seems unsteady or if you want the doors to close more easily, adjust the refrigerator's tilt using the instructions below:

1. Move the refrigerator into its final location.
2. Remove the base grille to locate the two leveling screws, which are part of the front roller assemblies on each side.
See *Graphic 8*.

NOTE: Having someone push against the top of the refrigerator takes some weight off the leveling screws and rollers. This makes it easier to adjust the screws.

3. Use a 1/2" hex-head socket wrench to adjust the leveling screws. Turn the leveling screw to the right to raise that side of the refrigerator or turn the leveling screw to the left to lower that side. It may take several turns of the leveling screws to adjust the tilt of the refrigerator. See *Graphic 8*.
4. Open both doors again and check that they close as easily as you like. If not, tilt the refrigerator slightly more to the rear by turning both leveling screws to the right. It may take several more turns, and you should turn both leveling screws the same amount.
5. Use a bubble level to check the leveling of the refrigerator.

NOTE: Whenever you need to move the refrigerator, turn the leveling feet to the right until they are no longer touching the ground. This will allow the refrigerator to roll more easily.

Door Alignment

A refrigerator that is not level from side-to-side may appear to have doors that are not properly aligned. If the doors appear this way, use the instructions in the previous section to check the leveling.

The doors are designed to be slightly different heights when the refrigerator is empty, in order to account for the weight of food that will be placed on the doors. If the doors are still not aligned after checking the leveling and loading the refrigerator with food, follow the steps below to adjust the door alignment.

1. Locate the alignment screw on the bottom hinge of the refrigerator door. See *Graphic 9*.
2. Use a 5/16" wrench to turn the screw. To raise the refrigerator door, turn the screw to the right. To lower the door, turn the screw to the left.
3. Check that the doors are even at the top and bottom. If necessary, continue to turn the alignment screw until the doors are aligned.
4. Replace the base grille.

NOTE: Be sure to refasten the Tech Sheet behind the base grille.

Handle Installation and Removal

PARTS INCLUDED: Door handles (2)

To Install the Handles:

1. Remove the handles, which are packed inside the refrigerator.
NOTE: To avoid scratching the finish, place the handles on a towel or other soft surface.
2. Open the freezer door. On the refrigerator door, place the handle on the shoulder screws.

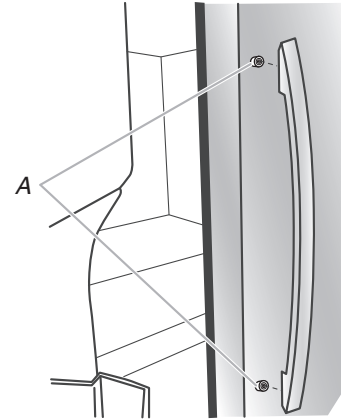

A. Shoulder screws

3. Firmly push the handle toward the door until the handle base is flush against the door.
4. While holding the handle, push downward until the handle rests firmly on shoulder screw.
5. Open the refrigerator door and close the freezer door. Repeat steps 2 through 4 to install the other handle onto the freezer door.

To Remove the Handles:

1. While holding the handle, push upward until the handle is released from the shoulder screw.
2. Gently pull the handle away from the door.
3. If necessary, use a Phillips screwdriver to remove the shoulder screws from the door.

Location Requirements

⚠ WARNING



Explosion Hazard

Keep flammable materials and vapors, such as gasoline, away from refrigerator.

Failure to do so can result in death, explosion, or fire.

IMPORTANT: This refrigerator is designed for indoor household use only.

To ensure proper ventilation for your refrigerator, allow for ½" (1.27 cm) of space on each side and at the top. Allow for 2" (5.08 cm) of space behind the refrigerator. If your refrigerator has an ice maker, allow extra space at the back for the water line connections. When installing your refrigerator next to a fixed wall, leave a 2" (5.08 cm) minimum space on each side (depending on your model) to allow the doors to swing open.

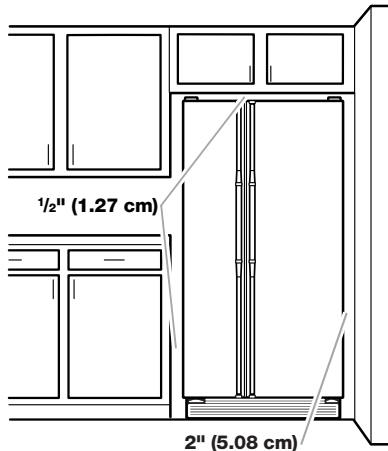

NOTES:

- This refrigerator is intended for use in a location where the temperature ranges from a minimum of 55°F (13°C) to a maximum of 110°F (43°C). The preferred room temperature range for optimum performance, which reduces electricity usage and provides superior cooling, is between 60°F (15°C) and 90°F (32°C). It is recommended that you do not install the refrigerator near a heat source, such as an oven or radiator.
- Normal minimum cabinet cut-out width required for product installation is 36" (91.44 cm). However, if the product is placed against an extended wall and the ability to remove the crisper pans is desired, an additional 18" (45.72 cm) of cabinet width is required, so a total cabinet opening width of 54" (137.16 cm) is recommended.

Electrical Requirements

⚠ WARNING



Electrical Shock Hazard

Plug into a grounded 3 prong outlet.

Do not remove ground prong.

Do not use an adapter.

Do not use an extension cord.

Failure to follow these instructions can result in death, fire, or electrical shock.

Before you move your refrigerator into its final location, it is important to make sure you have the proper electrical connection.

Recommended Grounding Method

A 115-volt, 60 Hz, AC-only, 15- or 20-amp fused, grounded electrical supply is required. It is recommended that a separate circuit serving only your refrigerator be provided. Use an outlet that cannot be turned off by a switch. Do not use an extension cord.

NOTE: Before performing any type of installation or cleaning, or removing a light bulb, turn cooling off or turn the control (Thermostat, Refrigerator or Freezer Control depending on the model) to OFF, and then disconnect the refrigerator from the electrical source. When you are finished, reconnect the refrigerator to the electrical source and turn cooling on or reset the control (Thermostat, Refrigerator or Freezer Control depending on the model) to the desired setting. See "Using the Controls" in the User Instructions, User Guide, or Use & Care Guide.

Water Supply Requirements

Gather the required tools and parts before starting installation. Read and follow the instructions provided with any tools listed here.

TOOLS NEEDED:

- Flat-blade screwdriver
- ¼" nut driver
- ⅞" and ½" open-end or two adjustable wrenches
- ¼" drill bit
- Cordless drill

NOTE: Your refrigerator dealer has a kit available with a ¼" (6.35 mm) saddle-type shutoff valve, a union, and copper tubing. Before purchasing, make sure a saddle-type valve complies with your local plumbing codes. Do not use a piercing-type or ⅜" (4.76 mm) saddle valve which reduces water flow and clogs more easily.

IMPORTANT:

- All installations must meet local plumbing code requirements.
- Use copper tubing and check for leaks. Install copper tubing only in areas where the household temperatures will remain above freezing.

Water Pressure

A cold water supply with water pressure of between 30 and 120 psi (207 and 827 kPa) is required to operate the water dispenser and ice maker. If you have questions about your water pressure, call a licensed, qualified plumber.

- If your refrigerator has a water dispenser: After installation is complete, use the water dispenser to check the water pressure.
 - With the water filter removed, dispense 1 cup (237 mL) of water. If 1 cup of water is dispensed in 8 seconds or less, the water pressure to the refrigerator meets the minimum requirement.
 - If it takes longer than 8 seconds to dispense 1 cup of water, the water pressure to the refrigerator is lower than recommended. See "Troubleshooting" for suggestions.

Reverse Osmosis Water Supply

IMPORTANT: The pressure of the water supply coming out of a reverse osmosis system going to the water inlet valve of the refrigerator needs to be between 30 and 120 psi (207 and 827 kPa).

If a reverse osmosis water filtration system is connected to your cold water supply, the water pressure to the reverse osmosis system needs to be a minimum of 40 to 60 psi (276 to 414 kPa).

If the water pressure to the reverse osmosis system is less than 40 to 60 psi (276 to 414 kPa):

- Check to see whether the sediment filter in the reverse osmosis system is blocked. Replace the filter if necessary.
- Allow the storage tank on the reverse osmosis system to refill after heavy usage.
- If your refrigerator has a water filter, it may further reduce the water pressure when used in conjunction with a reverse osmosis system. Remove the water filter. See "Water Filtration System" in the User Instructions, User Guide, or Use & Care Guide.

If you have questions about your water pressure, call a licensed, qualified plumber.

Connect Water Supply

Read all directions before you begin.

IMPORTANT:

- Plumbing shall be installed in accordance with the International Plumbing Code and any local codes and ordinances.
- The gray water tubing on the back of the refrigerator (which is used to connect to the household water line) is a PEX (cross-linked polyethylene) tube. Copper and PEX tubing connections from the household water line to the refrigerator are acceptable, and will help avoid off-taste or odor in your ice or water. Check for leaks.

If PEX tubing is used instead of copper, we recommend the following Whirlpool Part Numbers:

W10505928RP (7 ft [2.14 m] jacketed PEX),
8212547RP (5 ft [1.52 m] PEX), or
W10267701RP (25 ft [7.62 m] PEX).

- Install tubing only in areas where temperatures will remain above freezing.

TOOLS NEEDED:

Gather the required tools and parts before starting installation.

- Flat-blade screwdriver
- $\frac{7}{16}$ " and $\frac{1}{2}$ " open-end wrenches or two adjustable wrenches
- $\frac{1}{4}$ " nut driver

Connect to Water Line

IMPORTANT: If you turn the refrigerator on before the water line is connected, turn the ice maker OFF.

Style 1 (Recommended)

1. Unplug refrigerator or disconnect power.
2. Turn OFF main water supply. Turn ON nearest faucet long enough to clear line of water.
3. Use a quarter-turn shutoff valve or the equivalent, served by a $\frac{1}{2}$ " copper household supply line.

NOTE: To allow sufficient water flow to the refrigerator, a minimum $\frac{1}{2}$ " size copper household supply line is recommended.

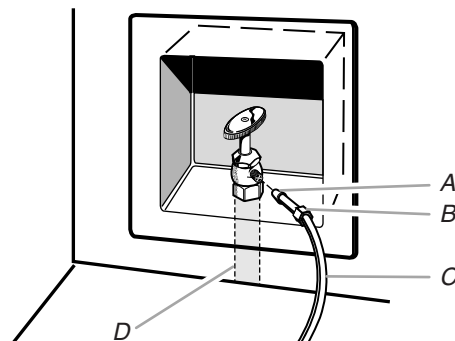

A. Bulb
B. Nut
C. Copper tubing (to refrigerator)
D. Household supply line ($\frac{1}{2}$ " minimum)

4. Now you are ready to connect the copper tubing to the shutoff valve. Use $\frac{1}{4}$ " (6.35 mm) O.D. (outside diameter) soft copper tubing to connect the shutoff valve and the refrigerator.
 - Ensure that you have the proper length needed for the job. Be sure both ends of the copper tubing are cut square.
 - Slip compression sleeve and compression nut onto copper tubing as shown. Insert end of tubing into outlet end and squarely as far as it will go. Screw compression nut onto outlet end with adjustable wrench. Do not overtighten.

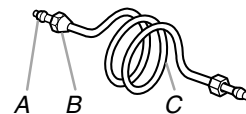

A. Compression sleeve
B. Compression nut
C. Copper tubing

5. Place the free end of the tubing into a container or sink, and turn on main water supply to flush out tubing until water is clear. Turn off shutoff valve on the water pipe.

NOTE: Always drain the water line before making the final connection to the inlet of the water valve, to avoid possible water valve malfunction.
6. Bend the copper tubing to meet the water line inlet, which is located on the back of the refrigerator cabinet as shown. Leave a coil of copper tubing to allow the refrigerator to be pulled out of the cabinet or away from the wall for service.

Style 2

1. Unplug refrigerator or disconnect power.
2. Turn OFF main water supply. Turn ON nearest faucet long enough to clear line of water.
3. Locate a $\frac{1}{2}$ " (1.27 cm) to $1\frac{1}{4}$ " (3.18 cm) vertical cold water pipe near the refrigerator.

IMPORTANT:

- Make sure it is a cold water pipe.
- Horizontal pipe will work, but drill on the top side of the pipe, not the bottom. This will help keep water away from the drill and normal sediment from collecting in the valve.

- Determine the length of copper tubing you need. Measure from the connection on the lower rear corner of refrigerator to the water pipe. Add 7 ft (2.1 m) to allow for cleaning. Use 1/4" (6.35 mm) O.D. (outside diameter) copper tubing. Be sure both ends of copper tubing are cut square.
- Using a cordless drill, drill a 1/4" (6.35 mm) hole in the cold water pipe you have selected.

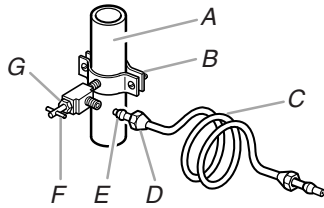

A. Cold water pipe
 B. Pipe clamp
 C. Copper tubing
 D. Compression nut
 E. Compression sleeve
 F. Shutoff valve
 G. Packing nut

- Fasten the shutoff valve to the cold water pipe with the pipe clamp. Be sure the outlet end is solidly in the 1/4" (6.35 mm) drilled hole in the water pipe and that the washer is under the pipe clamp. Tighten the packing nut. Tighten the pipe clamp screws slowly and evenly so the washer makes a watertight seal. Do not overtighten, or you may crush the copper tubing.
- Slip the compression sleeve and compression nut on the copper tubing as shown. Insert the end of the tubing into the outlet end squarely as far as it will go. Screw the compression nut onto outlet end with adjustable wrench. Do not overtighten.
- Place the free end of the tubing in a container or sink, and turn ON the main water supply. Flush the tubing until water is clear. Turn OFF the shutoff valve on the water pipe. Coil the copper tubing.

Connect to Refrigerator

Style 1

- Unplug refrigerator or disconnect power.
- Remove and discard the short, black plastic part from the end of the water line inlet.
- Thread the nut onto the end of the tubing. Tighten the nut by hand. Then tighten it with a wrench two more turns. Do not overtighten.

NOTE: To avoid rattling, be sure the copper tubing does not touch the cabinet's side wall or other parts inside the cabinet.

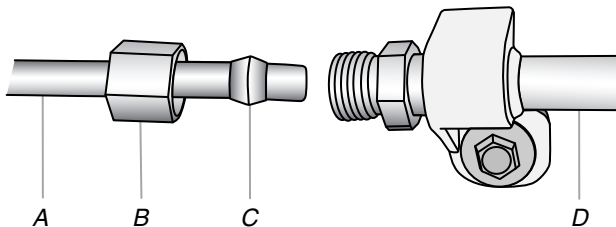

A. Household water line
 B. Nut (purchased)
 C. Ferrule (purchased)
 D. Refrigerator water tubing

- Install the water supply tube clamp around the water supply line to reduce strain on the coupling.
- Turn shutoff valve ON.
- Check for leaks. Tighten any connections (including connections at the valve) or nuts that leak.

Style 2

- Unplug refrigerator or disconnect power.
- Remove and discard the plastic part that is attached to the inlet of the water valve.
- Attach the copper tube to the valve inlet using a compression nut and sleeve as shown. Tighten the compression nut. Do not overtighten.
- Use the tube clamp on the back of the refrigerator to secure the tubing to the refrigerator as shown. This will help avoid damage to the tubing when the refrigerator is pushed back against the wall.
- Turn shutoff valve ON.
- Check for leaks. Tighten any connections (including connections at the valve) or nuts that leak.

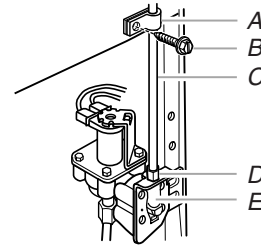

A. Tube clamp
 B. Tube clamp screw
 C. Copper tubing
 D. Compression nut
 E. Valve inlet

- On some models, the ice maker is equipped with a built-in water strainer. If your water conditions require a second water strainer, install it in the 1/4" (6.35 mm) water line at either tube connection. Obtain a water strainer from your nearest appliance dealer.

Style 3

- Unplug refrigerator or disconnect power.
- Remove and discard the black nylon plug from the gray water tube on the rear of the refrigerator.
- If the gray water tube supplied with the refrigerator is not long enough, a 1/4" x 1/4" (6.35 mm x 6.35 mm) coupling is needed in order to connect the water tubing to an existing household water line. Thread the provided nut onto the coupling on the end of the copper tubing.

NOTE: Tighten the nut by hand. Then tighten it with a wrench two more turns. Do not overtighten.

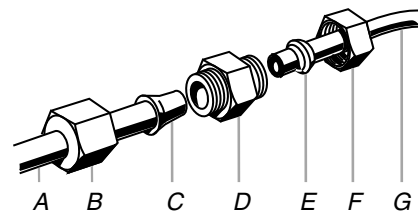

A. Refrigerator water tubing
 B. Nut (provided)
 C. Bulb
 D. Coupling (purchased)
 E. Ferrule (purchased)
 F. Nut (purchased)
 G. Household water line

- Turn shutoff valve ON.
- Check for leaks. Tighten any nuts or connections (including connections at the valve) that leak.

Complete the Installation

⚠ WARNING



Electrical Shock Hazard

Plug into a grounded 3 prong outlet.

Do not remove ground prong.

Do not use an adapter.

Do not use an extension cord.

Failure to follow these instructions can result in death, fire, or electrical shock.

1. Plug into a grounded 3 prong outlet.
2. Flush the water system. See “Water and Ice Dispensers” in the User Instructions or User Guide.

NOTE: Allow 24 hours to produce the first batch of ice. Allow 72 hours to completely fill ice container.

REFRIGERATOR USE

Using the Controls

For your convenience, your refrigerator controls are preset at the factory. When you first install your refrigerator, make sure that the controls are still preset. The Refrigerator Control and the Freezer Control should both be set to the “mid-settings.”

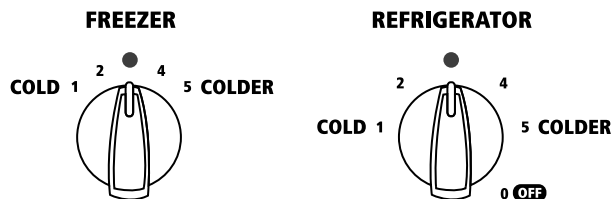

IMPORTANT:

- Your product will not cool when the REFRIGERATOR Control is set to OFF.
- The Refrigerator Control adjusts the refrigerator compartment temperature. The Freezer Control adjusts the freezer compartment temperature. Settings to the left of the mid-setting make the temperature less cold. Settings to the right of the mid-setting make the temperature colder.
- Wait 24 hours before you put food into the refrigerator. If you add food before the refrigerator has cooled completely, your food may spoil.

NOTE: Adjusting the Refrigerator and Freezer Controls to a higher (colder) than recommended setting will not cool the compartments any faster.

Adjusting Controls

Give the refrigerator time to cool down completely before adding food. It is best to wait 24 hours before you put food into the refrigerator. The settings indicated in the previous section should be correct for normal household refrigerator usage. The controls are set correctly when milk or juice is as cold as you like and when ice cream is firm.

- Turn the control right (clockwise) to make the compartment colder.
- Turn the control left (counterclockwise) to make it less cold.
- To turn the cooling system off, turn the Refrigerator Control counterclockwise until it reaches the OFF position.

If you need to adjust temperatures in the refrigerator or freezer, use the settings listed in the chart below as a guide. Wait at least 24 hours between adjustments.

CONDITION/REASON:	ADJUSTMENT:
REFRIGERATOR too warm	REFRIGERATOR Control one setting higher
FREEZER too warm/ too little ice	FREEZER Control one setting higher
REFRIGERATOR too cold	REFRIGERATOR Control one setting lower
FREEZER too cold	FREEZER Control one setting lower

Crisper Humidity Control (on some models)

You can control the amount of humidity in the moisture-sealed crisper. Adjust the control to any setting between LOW and HIGH.

LOW (open) for best storage of fruits and vegetables with skins.

HIGH (closed) for best storage of fresh, leafy vegetables.

Water and Ice Dispensers

NOTES:

- The dispensing system will not operate when either door (refrigerator or freezer) is open.
- Allow 24 hours for the refrigerator to cool down and chill water.
- Allow 24 hours to produce the first batch of ice. Discard the first three batches of ice produced. Wait 72 hours for full ice production.

Flush the Water System

Air in the water dispensing system can cause the water dispenser to drip. After connecting the refrigerator to a water source or replacing the water filter, flush the water system. Flushing the water dispensing system forces air from the water line and filter, and prepares the water filter for use.

NOTE: As air is cleared from the system, water may spurt out of the dispenser.

1. Using a sturdy container, depress and hold the water dispenser lever for 5 seconds, then release it for 5 seconds.
2. Repeat Step 1 until water begins to flow.
3. Once water begins to flow, continue depressing and releasing the dispenser lever (5 seconds on, 5 seconds off) until a total of 3 gal. (12 L) has been dispensed.

Additional flushing may be required in some households.

The Water Dispenser

IMPORTANT:

- Dispense at least 1 qt (1 L) of water every week to maintain a fresh supply.
- If the flow of water from the dispenser decreases, it could be caused by low water pressure.
 - With the water filter removed, dispense 1 cup (237 mL) of water. If 1 cup of water is dispensed in 8 seconds or less, the water pressure to the refrigerator meets the minimum requirement.
 - If it takes longer than 8 seconds to dispense 1 cup of water, the water pressure to the refrigerator is lower than recommended. See “Water Supply Requirements” or “Problem Solver” for suggestions.

To Dispense Water:

1. Press the WATER button to select water.

dispense



2. Press a sturdy glass against the dispenser lever. Hold the glass close to the water dispenser spout to ensure that the water dispenses into the glass.

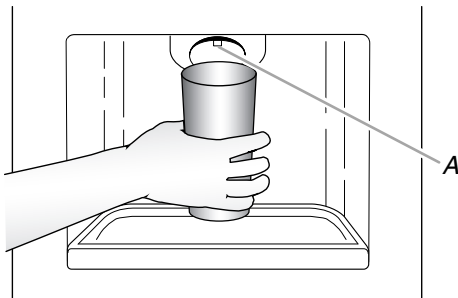

A. Water dispenser spout

3. Remove the glass to stop dispensing.

IMPORTANT: The small tray at the bottom of the dispenser is designed to catch small spills and allow for easy cleaning. There is no drain in the tray. To empty and clean the tray, push down on the back of the removable tray lid and pull it out.

The Ice Dispenser

Ice dispenses from the ice maker storage bin in the freezer when the dispenser lever is pressed. To turn off the ice maker, see “Ice Maker and Storage Bin.”

Your ice maker can produce both crushed and cubed ice. Before dispensing ice, select which type of ice you prefer.

- Press the CRUSHED button for crushed ice, or the CUBED button for cubed ice.

dispense



For crushed ice, cubes are crushed before being dispensed. This may cause a slight delay when dispensing crushed ice. Noise from the ice crusher is normal, and pieces of ice may vary in size. When changing from crushed to cubed, a few ounces of crushed ice will be dispensed along with the first cubes.

To Dispense Ice:

1. Press the button to select the desired type of ice.

! WARNING



Cut Hazard

Use a sturdy glass when dispensing ice.

Failure to do so can result in cuts.

2. Press a sturdy glass against the ice dispenser lever. Hold the glass close to the ice guide to ensure that the ice dispenses into the glass.

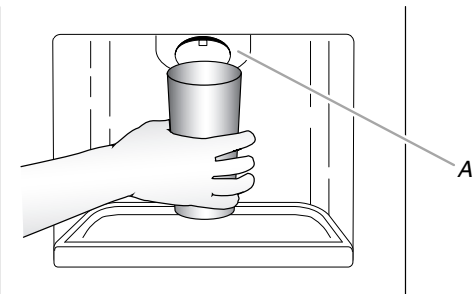

A. Ice guide

IMPORTANT: You do not need to apply a lot of pressure to the lever in order to activate the ice dispenser. Pressing hard will not make the ice dispense faster or in greater quantities.

3. Remove the glass to stop dispensing.

The Dispenser Light

On some models, the dispenser light will automatically turn on when you use the dispenser.

- If you want the light to be on continuously, press the ON button on the left side of the dispenser panel. To turn the light back off, press the OFF button on the left side of the dispenser panel.



The dispenser lights are LEDs that cannot be changed. If it appears that your dispenser lights are not working, see “Problem Solver” for more information.

The Dispenser Lock

The dispenser can be turned off for easy cleaning or to avoid unintentional dispensing by small children and pets.

NOTE: The lock feature does not shut off power to the refrigerator, to the ice maker, or to the dispenser light. It simply deactivates the dispenser lever. To turn off the ice maker, see “Ice Maker and Storage Bin.”

- To lock the dispenser, press the ON button on the right-hand side of the dispenser panel. To unlock the dispenser, press the OFF button on the right-hand side of the dispenser panel.

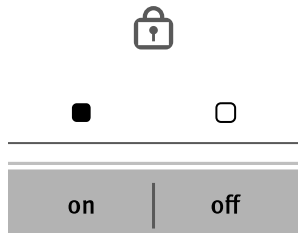

Ice Maker and Storage Bin

- Allow 24 hours to produce the first batch of ice. Discard the first three batches of ice produced.
- The quality of your ice will be only as good as the quality of the water supplied to your ice maker. Avoid connecting the ice maker to a softened water supply. Water softener chemicals (such as salt) can damage parts of the ice maker and lead to poor quality ice. If a softened water supply cannot be avoided, make sure the water softener is operating properly and is well maintained.
- Do not use anything sharp to break up the ice in the storage bin. This can cause damage to the ice container and the dispenser mechanism.
- Do not store anything on top of or in the ice maker or storage bin.

Turning the Ice Maker On/Off

- To turn on the ice maker, lift open the ice maker door and lower the wire shutoff arm to the ON position.
- To manually turn off the ice maker, lift the wire shutoff arm to the OFF (arm up) position and listen for the click. Ice can still be dispensed, but no more can be made.

NOTE: Your ice maker has an automatic shutoff. As ice is made, the ice cubes will fill the ice storage bin, and the ice cubes will raise the wire shutoff arm to the OFF (arm up) position. Do not force the wire shutoff arm up or down.

Removing and Replacing the Ice Storage Bin

1. Lift and hold open the ice maker door.
2. Lift the wire shutoff arm so it clicks into the OFF (up) position. Release the ice maker door.
3. Lift up the front of the storage bin and pull it out.

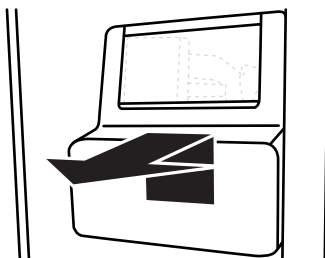

4. Replace the bin by pushing it in all the way, or the dispenser will not work.
5. To restart ice production, lift open the ice maker door and push the wire shutoff arm down to the ON position.

Water Filtration System

Do not use with water that is microbiologically unsafe or of unknown quality without adequate disinfection before or after the system. Systems certified for cyst reduction may be used on disinfected waters that may contain filterable cysts.

Water Filter Status Light (on some models)

The filter status light will help you know when to change your water filter.

- The light will change from green to yellow. This tells you that it is almost time to change the filter.
- It is recommended that you replace the filter when the status light changes to red OR water flow to your water dispenser or ice maker decreases noticeably.

NOTE: The filter should be replaced at least every 6 months, depending on your water quality and usage.

Resetting the Filter Status

- The reset button is located on the control panel in the refrigerator compartment. To reset the status light after changing the filter, press the button 5 times within 10 seconds. The status light will change from red to green when the system is reset.

Non-Indicator Water Filter (on some models)

If your refrigerator does not have the water filter status light, you should change the water filter cartridge at least every 6 months depending on your water quality and usage. If the water flow to the water dispenser or ice maker decreases noticeably before 6 months have passed, replace the water filter more often.

Changing the Water Filter

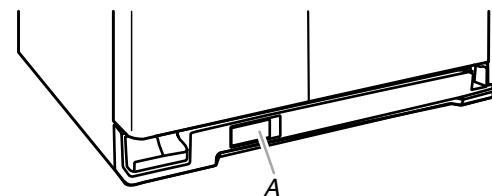

A. Water filter cover door

1. Locate the water filter cover door in the base grille, and pull open the filter door. The filter will be released and then be ejected as the door is opened.
2. When the door is completely open, pull the filter straight out.

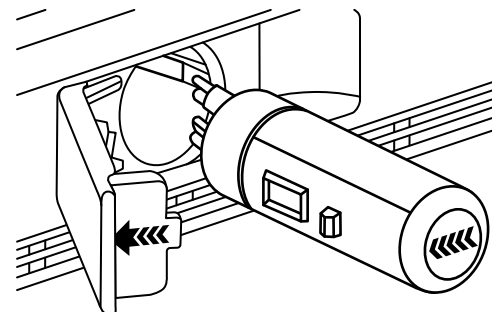

NOTE: There may be some water in the filter. Some spilling may occur. Use a towel to wipe up any spills.

- Take the new filter out of its packaging and remove the cap. Be sure the O-rings are still in place after the cap is removed.

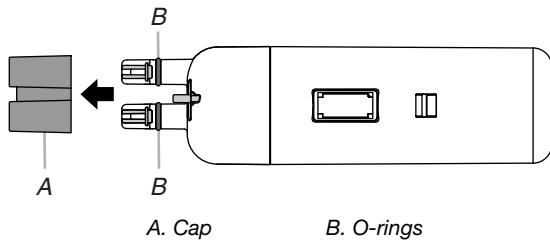

- With the arrow pointing to the left (toward the filter cover door's hinge), align the new filter with the filter housing and slide it into place. The filter cover door will automatically begin to close as the new filter is inserted.
- Close the filter cover door completely in order to snap the filter into place. You may need to press hard.
- Flush the water system. See "Water and Ice Dispensers."

REFRIGERATOR CARE

Cleaning

⚠ WARNING



Explosion Hazard

Use nonflammable cleaner.

Failure to do so can result in death, explosion, or fire.

Both the refrigerator and freezer sections defrost automatically. However, clean both sections about once a month to avoid buildup of odors. Wipe up spills immediately.

IMPORTANT: Because air circulates between both sections, any odors formed in one section will transfer to the other. You must thoroughly clean both sections to eliminate odors. To avoid odor transfer and drying out of food, wrap or cover foods tightly.

To Clean Your Refrigerator:

NOTE: Do not use abrasive or harsh cleaners such as window sprays, scouring cleansers, flammable fluids, cleaning waxes, concentrated detergents, bleaches or cleansers containing petroleum products on plastic parts, interior and door liners or gaskets. Do not use paper towels, scouring pads, or other harsh cleaning tools.

- Unplug refrigerator or disconnect power.
- Hand wash, rinse, and dry removable parts and interior surfaces thoroughly. Use a clean sponge or soft cloth and a mild detergent in warm water.
- Wash stainless steel and painted metal exteriors with a clean sponge or soft cloth and a mild detergent in warm water.
- There is no need for routine condenser cleaning in normal home operating environments. If the environment is particularly greasy or dusty, or there is significant pet traffic in the home, the condenser should be cleaned every 2 to 3 months to ensure maximum efficiency.

If you need to clean the condenser:

- Remove the base grille. See the "Door Removal" instructions, either in the User Instructions or the Installation Instructions and Owner's Manual, or in the separate instruction sheet provided with your refrigerator.
 - Use a vacuum cleaner with a soft brush to clean the grille, the open areas behind the grille and the front surface area of the condenser.
 - Replace the base grille when finished.
- Plug in refrigerator or reconnect power.

Lights

The interior and dispenser lights are LEDs that cannot be changed.

- If the dispenser lights do not appear to be working as described in "Water and Ice Dispensers" (in the User Instructions, User Guide, or Use & Care Guide) or if the interior lights do not illuminate when either door is opened, call for assistance or service. See either the front cover or the Warranty for contact information.

Vacation and Moving Care

Vacations

If You Choose to Leave Refrigerator On While You Are Away:

- Use up any perishables and freeze other items.
- If your refrigerator has an automatic ice maker and is connected to the household water supply, turn off the water supply to the refrigerator. Property damage can occur if the water supply is not turned off.
- If you have an automatic ice maker, turn off the ice maker.

NOTE: Depending on your model, raise the wire shutoff arm to OFF (up) position or press the switch to OFF.
- Empty the ice bin.

If You Choose to Turn Refrigerator Off Before You Leave:

- Remove all food from the refrigerator.
- If your refrigerator has an automatic ice maker:
 - Turn off the water supply to the ice maker at least one day ahead of time.
 - When the last load of ice drops, raise the wire shutoff arm to the OFF (up) position or move the switch to the OFF setting.
- Depending on the model, turn the Refrigerator Control to OFF or turn cooling off. See "Using the Controls" in the User Instructions, User Guide, or Use & Care Guide.
- Clean, wipe, and dry thoroughly.
- Tape rubber or wood blocks to the tops of both doors to prop them open far enough for air to get in. This stops odor and mold from building up.

Moving

When you are moving your refrigerator to a new home, follow these steps to prepare it for the move.

- If your refrigerator has an automatic ice maker:
 - Turn off the water supply to the ice maker at least one day ahead of time.
 - Disconnect the water line from the back of the refrigerator.
 - When the last load of ice drops, raise the wire shutoff arm to the OFF (up) position or move the switch to the OFF setting.

2. Remove all food from the refrigerator and pack all frozen food in dry ice.
 3. Empty the ice bin.
 4. Depending on the model, turn the Refrigerator Control to OFF or turn cooling off. See “Using the Controls” in the User Instructions, User Guide, or Use & Care Guide.
 5. Unplug refrigerator.
 6. Clean, wipe, and dry thoroughly.
 7. Take out all removable parts, wrap them well, and tape them together so they don’t shift and rattle during the move.
 8. Depending on the model, raise the front of the refrigerator so it rolls more easily OR screw in the leveling legs so they don't scrape the floor. See “Adjust the Doors” or “Door Removal, Leveling and Alignment.”
 9. Tape the doors closed and tape the power cord to the back of the refrigerator.
- When you get to your new home, put everything back and refer to the Installation Instructions for preparation instructions. Also, if your refrigerator has an automatic ice maker, remember to reconnect the water supply to the refrigerator.

TROUBLESHOOTING

First try the solutions suggested here. If you need further assistance or more recommendations that may help you avoid a service call, refer to the warranty page in this manual and scan the code with your mobile device, or visit <http://amana.custhelp.com>. In Canada, visit www.amanacanada.ca.

Contact us by mail with any questions or concerns at the address below:

In the U.S.A.:

Amana Brand Home Appliances
Customer eXperience Center
553 Benson Road
Benton Harbor, MI 49022-2692

In Canada:

Amana Brand Home Appliances
Customer eXperience Centre
200 – 6750 Century Ave.
Mississauga, Ontario L5N 0B7

Please include a daytime phone number in your correspondence.

⚠ WARNING



Electrical Shock Hazard

Plug into a grounded 3 prong outlet.

Do not remove ground prong.

Do not use an adapter.

Do not use an extension cord.

Failure to follow these instructions can result in death, fire, or electrical shock.

GENERAL OPERATION

Possible Causes and/or Recommended Solutions

- | | |
|---|---|
| <p>Refrigerator will not operate</p> | <ul style="list-style-type: none"> ■ Not connected to an electrical supply - Plug the power cord into a grounded 3 prong outlet. Do not use an extension cord. ■ No power to the electrical outlet - Plug in a lamp to see if the outlet is working. ■ Household fuse has blown or circuit breaker has tripped - Replace the fuse or reset the circuit breaker. If the problem continues, contact a licensed electrician. ■ Control or cooling is not turned on - Turn on the refrigerator control, or turn cooling on. See “Using the Controls.” ■ New installation - Following installation, allow 24 hours for the refrigerator and freezer to cool completely. <p>NOTE: Adjusting the temperature control(s) to the coldest setting will not cool either compartment (refrigerator or freezer) more quickly.</p> |
| <p>Motor seems to run too much</p> | <ul style="list-style-type: none"> ■ Your new refrigerator has an energy-efficient motor - The refrigerator may run longer than you’re used to, because the compressor and fans operate at lower speeds that are more energy-efficient. This is normal. <p>NOTE: Your refrigerator may run even longer if the room is warm, a large load of food is added, the doors are opened often, or if a door has been left open.</p> |

GENERAL OPERATION	Possible Causes and/or Recommended Solutions
Refrigerator seems noisy	<p>The compressor in your new refrigerator regulates temperature more efficiently and uses less energy than older models. During various stages of operation, you may hear normal operating sounds that are unfamiliar.</p> <p>The following noises are normal:</p> <ul style="list-style-type: none"> ■ Buzzing/Clicking - Heard when the water valve opens and closes to dispense water or fill the ice maker. If the refrigerator is connected to a water line, this is normal. If the refrigerator is not connected to a water line, turn off the ice maker. ■ Cracking/Crashing - Heard when ice is ejected from the ice maker mold. ■ Popping - Heard when the inside walls contract/expand, especially during initial cooldown. ■ Pulsating/Whirring - Heard when the fans/compressor adjust to optimize performance during normal operation. ■ Rattling - Heard when water passes through the water line, or due to the flow of refrigerant. Rattling may also come from items placed on top of the refrigerator. ■ Water running or gurgling - Heard when ice melts during the Defrost cycle and water runs into the drain pan. ■ Sizzling - Heard when water drips onto the heater during the Defrost cycle.
Temperature is too warm	<ul style="list-style-type: none"> ■ New installation - Following installation, allow 24 hours for the refrigerator and freezer to cool completely. <p>NOTE: Adjusting the temperature control(s) to the coldest setting will not cool either compartment (refrigerator or freezer) more quickly.</p> <ul style="list-style-type: none"> ■ Doors are opened often or not closed completely - This allows warm air to enter the refrigerator. Minimize door openings, keep the doors fully closed, and make sure both doors are properly sealed. ■ Air vents are blocked - Remove items that are immediately in front of the vents. ■ Large amount of warm food recently added - Allow several hours for the refrigerator to return to its normal temperature. ■ Controls are not set correctly for the surrounding conditions - Adjust the controls to a colder setting. Check the temperature again in 24 hours.
Temperature is too cold	<ul style="list-style-type: none"> ■ Controls are not set correctly for the surrounding conditions - Adjust the controls to a warmer setting. Check the temperature again in 24 hours. ■ Top refrigerator shelf is colder than lower shelves - On some models, air from the freezer enters the refrigerator compartment through vents near the top refrigerator shelf. As a result, the top shelf can be slightly colder than lower shelves. ■ Air vents are blocked - Remove items that are immediately in front of the vents.
Interior moisture buildup	<p>NOTE: Some moisture buildup is normal. Clean with a soft dry cloth.</p> <ul style="list-style-type: none"> ■ Room is humid - A humid environment contributes to moisture buildup. Use the refrigerator only in an indoor location, with as little humidity as possible. ■ Doors are opened often or not closed completely - This allows humid air to enter the refrigerator. Minimize door openings, keep the doors fully closed, and make sure both doors are properly sealed.
Interior lights do not work	<ul style="list-style-type: none"> ■ Doors have been open for an extended period of time - Close the doors to reset the lights. ■ Light bulb is loose in the socket or has burned out - On models with incandescent or full-size LED interior light bulbs, tighten or replace the bulb. See "Lights." <p>NOTE: On models with mini LED lights, call for assistance or service if the interior lights do not illuminate when either door is opened. See either the front cover or the Warranty for contact information.</p>
Dispenser lights do not work (on some models)	<ul style="list-style-type: none"> ■ Dispenser light is turned off - On some models, if the dispenser light is set to OFF, the light will turn on only when a dispenser pad/lever is pressed. If you want the dispenser light to stay on continuously, select a different setting. See "Water and Ice Dispensers." ■ Dispenser light is set to AUTO or NIGHT LIGHT - On some models, if the dispenser light is set to AUTO or NIGHT LIGHT, make sure the dispenser light sensor is not blocked. See "Water and Ice Dispensers." <p>NOTE: On models with mini LED lights, call for assistance or service if the dispenser lights do not operate correctly. See either the front cover or the Warranty for contact information.</p>

⚠ WARNING



Explosion Hazard
Use nonflammable cleaner.
Failure to do so can result in death, explosion, or fire.

DOORS AND LEVELING	Possible Causes and/or Recommended Solutions
Doors are difficult to open	<ul style="list-style-type: none"> ■ Gaskets are dirty or sticky - Clean the gaskets and contact surfaces with mild soap and warm water. Rinse and dry with a soft cloth.
Doors will not close completely	<ul style="list-style-type: none"> ■ Door is blocked open - Move food packages away from the door. Make sure all bins and shelves are in their correct positions. Make sure all packaging materials have been removed.
Doors appear to be uneven	<ul style="list-style-type: none"> ■ Doors need to be aligned, or refrigerator needs to be leveled - See the leveling and door alignment instructions.
Refrigerator rocks and is not stable	<ul style="list-style-type: none"> ■ Refrigerator is not level - To stabilize the refrigerator, remove the base grille and lower the leveling feet until they touch the floor. See the leveling and door alignment instructions.

⚠ WARNING



Cut Hazard
Use a sturdy glass when dispensing ice.
Failure to do so can result in cuts.

ICE AND WATER	Possible Causes and/or Recommended Solutions
Ice maker is not producing ice, not producing enough ice, or producing small/hollow ice	<ul style="list-style-type: none"> ■ Refrigerator is not connected to a water supply, or the water supply shutoff valve is not fully turned on - Connect the refrigerator to a water supply and make sure the water shutoff valve is fully open. ■ Kink in the water source line - A kink in the water line can reduce water flow, resulting in decreased ice production, small ice cubes, and/or hollow or irregularly-shaped ice. Straighten the water line. ■ Ice maker is not turned on - Turn on the ice maker. See “Ice Maker and Storage Bin.” ■ New installation - After connecting the refrigerator to a water source, flush the water system. (See “Water and Ice Dispensers.”) Wait 24 hours for ice production to begin. Wait 72 hours for full ice production. Discard the first three batches of ice produced. ■ Large amount of ice was recently removed - Allow sufficient time for the ice maker to produce more ice. ■ Ice is jammed in the ice maker ejector arm (on some models) - Remove ice from the ejector arm using a plastic utensil. ■ Inadequate water pressure - Verify that the household has adequate water pressure. See “Water Supply Requirements.” ■ Water filter is installed incorrectly - Make sure the filter is properly installed. See “Water Filtration System.” ■ A reverse osmosis water filtration system is connected to your cold water supply - This can decrease water pressure. See “Water Supply Requirements.” <p>NOTE: If questions remain regarding water pressure, contact a licensed, qualified plumber.</p>

ICE AND WATER	Possible Causes and/or Recommended Solutions
Ice dispenser will not operate properly	<ul style="list-style-type: none"> ■ Doors not closed completely - Make sure both doors are firmly closed. (On some models, only the freezer door must be closed in order to operate the dispenser.) ■ New installation - After connecting the refrigerator to a water source, flush the water system. (See “Water and Ice Dispensers.”) Wait 24 hours for ice production to begin. Wait 72 hours for full ice production. Discard the first three batches of ice produced. ■ Ice maker is not turned on, or ice bin is not installed correctly - Turn on the ice maker and make sure the ice storage bin is firmly in position. See “Ice Maker and Storage Bin.” ■ Ice is clogged or frozen together in the ice storage bin, or ice is blocking the ice delivery chute - Remove or separate the clogged ice, using a plastic utensil if necessary. Clean the ice delivery chute and the bottom of the ice storage bin using a warm damp cloth, then dry both thoroughly. To avoid clogging and to maintain a fresh supply of ice, empty the storage bin and clean both the storage bin and the delivery chute every 2 weeks. ■ Wrong ice has been added to the storage bin - Use only ice cubes produced by the current ice maker. ■ Dispenser is locked - Unlock the dispenser. See “Water and Ice Dispensers.” ■ Ice dispenser jams while dispensing crushed ice - For models with the ice storage bin on the door, temporarily switch from crushed ice to cubed ice to clear the jam. ■ Dispenser pad/lever has been pressed too long - Ice will automatically stop dispensing. Wait a few minutes for the dispenser to reset, then resume dispensing. Take large amounts of ice directly from the ice bin, not through the dispenser. ■ Water pressure to the home is not at or above 30 psi (207 kPa) - The water pressure to the home affects the flow from the dispenser. See “Water Supply Requirements.” ■ Water filter is clogged or incorrectly installed - Replace filter or reinstall it correctly. See “Water Filtration System.”
Ice or water has an off-taste, odor, or gray color	<ul style="list-style-type: none"> ■ New plumbing connections - New plumbing connections can result in off-flavored or discolored ice or water. This problem should go away over time. ■ Ice has been stored too long - Discard the ice and wash the ice bin. Allow 24 hours for the ice maker to produce new ice. ■ Odor has transferred from food - Use airtight moisture-proof packaging to store food. ■ Use of non-recommended water supply line - Odors and tastes can transfer from certain materials used in non-recommended water supply lines. Use only a recommended water supply line. See “Water Supply Requirements.” ■ There are minerals (such as sulfur) in the water - A water filter may need to be installed in order to remove the minerals. ■ Water filter was recently installed or replaced - Gray or dark discoloration in ice or water indicates that the water filtration system needs additional flushing. See “Water and Ice Dispensers.”
Water dispenser will not operate properly	<ul style="list-style-type: none"> ■ Doors not closed completely - Make sure both doors are firmly closed. (On some models, only the freezer door must be closed in order to operate the dispenser.) ■ Refrigerator is not connected to a water supply, or the water supply shutoff valve is not turned on - Connect the refrigerator to a water supply and make sure the water shutoff valve is fully open. ■ Kink in the water source line - A kink in the water line can reduce water flow to the dispenser. Straighten the water line. ■ Water pressure to the home is not at or above 30 psi (207 kPa) - The water pressure to the home affects the flow from the dispenser. See “Water Supply Requirements.” ■ New installation - After connecting the refrigerator to a water source, flush the water system. See “Water and Ice Dispensers.” ■ Dispenser is locked - Unlock the dispenser. See “Water and Ice Dispensers.” ■ Water filter is clogged or incorrectly installed - Replace filter or reinstall it correctly. See “Water Filtration System.” ■ A reverse osmosis water filtration system is connected to your cold water supply - This can decrease water pressure. See “Water Supply Requirements.” <p>NOTE: If questions remain regarding water pressure, contact a licensed, qualified plumber.</p>
Water is leaking or dripping from the dispenser	<p>NOTE: After dispensing, a few additional drops of water are normal.</p> <ul style="list-style-type: none"> ■ Glass was not held under the dispenser long enough - Hold the glass under the dispenser for 2 to 3 seconds after releasing the dispenser pad/lever. ■ New installation, or water filter was recently installed or replaced - Air in the water lines causes the water dispenser to drip. Flush the water system to remove the air in the water lines. See “Water and Ice Dispensers.” ■ Residual ice in the dispenser chute is melting - Make sure the ice chute is free of ice shavings or pieces.

ICE AND WATER	Possible Causes and/or Recommended Solutions
Water is leaking from the back of the refrigerator	<ul style="list-style-type: none"> ■ Water line connections are not fully tightened - Make sure all connections are firmly tightened. See "Connect Water Supply."
Water from the dispenser is not cool enough (on some models)	<p>NOTE: Water from the dispenser is chilled to 50°F (10°C).</p> <ul style="list-style-type: none"> ■ New installation - Allow 24 hours after installation for the water supply to cool completely. ■ Recently dispensed a large amount of water - Allow 24 hours for the new water supply to cool completely. ■ Water has not been recently dispensed - The first glass of water may not be cool. Discard the first glass of water dispensed. ■ Refrigerator is not connected to a cold water pipe - Make sure the refrigerator is connected to a cold water pipe. See "Water Supply Requirements."

ACCESSORIES

The following accessories are available for your refrigerator.

To order an accessory: Contact us and ask for the part number listed, or contact your authorized dealer.

In the U.S.A., call **1-800-442-9991** or visit **www.amana.com**.

In Canada, call **1-800-807-6777** or visit **www.amanacanada.ca**.

affresh® Stainless Steel Cleaner:

Order Part #W10355016

In Canada, order Part #W10355016B

affresh® Stainless Steel Wipes:

Order Part #W10355049

In Canada, order Part #W10355049B

affresh® Kitchen & Appliance Cleaner:

Order Part #W10355010

In Canada, order Part #W10355010B

Water Filter:

Order Part #W10295370A (P4RFWB)



PERFORMANCE DATA SHEET

Water Filtration System Model P8WB2L/P8RFWB2L Capacity 200 Gallons (757 Liters)



System tested and certified by NSF International against NSF/ANSI Standard 42, Standard 53, and Standard 401 for the reduction of contaminants specified on the Performance Data Sheet.

This system has been tested according to NSF/ANSI Standards 42, 53 and 401 for the reduction of the substances listed below. The concentration of the indicated substances in water entering the system was reduced to a concentration less than or equal to the permissible limit for water leaving the system, as specified in NSF/ANSI Standards 42, 53 and 401.

Substance Reduction Aesthetic Effects	Influent Challenge Concentration	Maximum Permissible Product Water Concentration	Average% Reduction
Chlorine Taste/Odor Particulate Class I*	2.0 mg/L ± 10% At least 10,000 particles/mL	50% reduction 85% reduction	97.0% >99.9%
Contaminant Reduction	Influent Challenge Concentration	Maximum Permissible Product Water Concentration	Average% Reduction
Lead: @ pH 6.5 / @ pH 8.5	0.15 mg/L ± 10%	0.010 mg/L	>99.3% / 98.6%
Benzene	0.015 mg/L ± 10%	0.005 mg/L	93.8%
p-Dichlorobenzene	0.225 mg/L ± 10%	0.075 mg/L	99.8%
Carbofuran	0.08 mg/L ± 10%	0.040 mg/L	81.9%
Toxaphene	0.015 ± 10%	0.003 mg/L	>95%
Atrazine	0.009 mg/L ± 10%	0.003 mg/L	87.0%
Asbestos	10 ⁷ to 10 ⁸ fibers/L ^{††}	99%	>99%
Live Cysts [†]	50,000/L min.	99.95%	>99.99%
Turbidity	11 NTU ± 10%	0.5 NTU	96.9%
Lindane	0.002 ± 10%	0.0002 mg/L	>99.2%
Tetrachloroethylene	0.015 mg/L ± 10%	0.005 mg/L	96.6%
o-Dichlorobenzene	1.8 mg/L ± 10%	0.60 mg/L	92.3%
Ethylbenzene	2.1 mg/L ± 10%	0.70 mg/L	86.9%
1,2,4-Trichlorobenzene	0.210 mg/L ± 10%	0.07 mg/L	>99.8%
2,4 - D	0.210 mg/L ± 10%	0.07 mg/L	88.5%
Styrene	2.0 mg/L ± 10%	0.1 mg/L	99.6%
Toluene	3.0 mg/L ± 10%	1.0 mg/L	93.5%
Endrin	0.006 mg/L ± 10%	0.002 mg/L	81.7%
Atenolol	200 ± 20%	30 ng/L	95.7%
Trimethoprim	140 ± 20%	20 ng/L	96.1%
Linuron	140 ± 20%	20 ng/L	96.3%
Estrone	140 ± 20%	20 ng/L	95.3%
Nonylphenol	1400 ± 20%	200 ng/L	95.5%

Test Parameters: pH = 7.5 ± 0.5 unless otherwise noted. Flow = 0.75 gpm (2.84 Lpm). Pressure = 60 psig (413.7 kPa). Temp. = 68°F to 71.6°F (20°C to 22°C). Rated service capacity = 200 gallons (757 liters).

The compounds certified under NSF 401 have been deemed as “emerging compounds/incidental contaminants.” Emerging compounds/incidental contaminants are those compounds that have been detected in drinking water supplies at trace levels. While occurring at only trace levels, these compounds can affect the public acceptance/perception of drinking water quality.

- It is important that operational, maintenance, and filter replacement requirements be carried out for the product to perform as advertised. Property damage can occur if all instructions are not followed.
- The disposable cartridge must be changed at least every 6 months.
- Use replacement filter P8RFWB2L, part #EDR1RXD1/EDR1RXD1B. 2015 suggested retail price of \$49.99 U.S.A./\$49.99 Canada. Prices are subject to change without notice.
- The filter monitor system measures the amount of water that passes through the filter and alerts you when it is time to replace the filter. Refer to the “Using the Controls” or “Water Filtration System” section (in the User Instructions or User Guide) to learn how to check the water filter status.
- After changing the water filter, flush the water system. See “Water and Ice Dispensers” or “Water Dispenser” in the User Instructions or User Guide.
- These contaminants are not necessarily in your water supply. While testing was performed under standard laboratory conditions, actual performance may vary.
- The product is for cold water use only.
- The water system must be installed in compliance with state and local laws and regulations.
- Do not use with water that is microbiologically unsafe or of unknown quality without adequate disinfection before or after the system. Systems certified for cyst reduction may be used on disinfected waters that may contain filterable cysts. EPA Est. No. 082047-TWN-001
- Refer to the “Warranty” section (in the User Instructions or User Guide) for the Manufacturer’s limited warranty, name and telephone number.

Application Guidelines/Water Supply Parameters

Water Supply	Potable City or Well
Water Pressure	30 - 120 psi (207 - 827 kPa)
Water Temperature	33° - 100°F (0.6° - 37.8°C)
Service Flow Rate	0.75 gpm (2.84 L/min) @ 60 psi

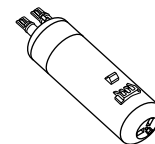

*Class I particle size: >0.5 to <1 um

†Based on the use of *Cryptosporidium parvum* oocysts

††Fibers greater than 10 um in length

AMANA® MAJOR APPLIANCE LIMITED WARRANTY

ATTACH YOUR RECEIPT HERE. PROOF OF PURCHASE IS REQUIRED TO OBTAIN WARRANTY SERVICE.

Please have the following information available when you call the Customer eXperience Center:

- Name, address and telephone number
- Model number and serial number
- A clear, detailed description of the problem
- Proof of purchase including dealer or retailer name and address

IF YOU NEED SERVICE:

1. Before contacting us to arrange service, please determine whether your product requires repair. Some questions can be addressed without service. Please take a few minutes to review the Troubleshooting or Problem Solver section of the Use and Care Guide, scan the QR code on the right to access additional resources, or visit <http://amana.custhelp.com>.
2. All warranty service is provided exclusively by our authorized Amana Service Providers. In the U.S. and Canada, direct all requests for warranty service to:

Amana Customer eXperience Center

In the U.S.A., call 1-800-843-0304. In Canada, call 1-800-807-6777.

If outside the 50 United States or Canada, contact your authorized Amana dealer to determine whether another warranty applies.



<http://amana.custhelp.com>

ONE YEAR LIMITED WARRANTY

WHAT IS COVERED

For one year from the date of purchase, when this major appliance is installed, operated and maintained according to instructions attached to or furnished with the product, Amana brand of Whirlpool Corporation or Whirlpool Canada LP (hereafter "Amana") will pay for Factory Specified Replacement Parts and repair labor to correct defects in materials or workmanship that existed when this major appliance was purchased, or at its sole discretion replace the product. In the event of product replacement, your appliance will be warranted for the remaining term of the original unit's warranty period.

YOUR SOLE AND EXCLUSIVE REMEDY UNDER THIS LIMITED WARRANTY SHALL BE PRODUCT REPAIR AS PROVIDED HEREIN. Service must be provided by a Amana designated service company. This limited warranty is valid only in the United States or Canada and applies only when the major appliance is used in the country in which it was purchased. This limited warranty is effective from the date of original consumer purchase. Proof of original purchase date is required to obtain service under this limited warranty.

WHAT IS NOT COVERED

1. Commercial, non-residential, multiple-family use, or use inconsistent with published user, operator or installation instructions.
2. In-home instruction on how to use your product.
3. Service to correct improper product maintenance or installation, installation not in accordance with electrical or plumbing codes or correction of household electrical or plumbing (i.e. house wiring, fuses or water inlet hoses).
4. Consumable parts (i.e. light bulbs, batteries, air or water filters, preservation solutions, etc.).
5. Defects or damage caused by the use of non-genuine Amana parts or accessories.
6. Conversion of products from natural gas or L.P. gas.
7. Damage from accident, misuse, abuse, fire, floods, acts of God or use with products not approved by Amana.
8. Repairs to parts or systems to correct product damage or defects caused by unauthorized service, alteration or modification of the appliance.
9. Cosmetic damage including scratches, dents, chips, and other damage to the appliance finishes unless such damage results from defects in materials and workmanship and is reported to Amana within 30 days.
10. Discoloration, rust or oxidation of surfaces resulting from caustic or corrosive environments including but not limited to high salt concentrations, high moisture or humidity or exposure to chemicals.
11. Food or medicine loss due to product failure.
12. Pick-up or delivery. This product is intended for in-home repair.
13. Travel or transportation expenses for service in remote locations where an authorized Amana servicer is not available.
14. Removal or reinstallation of inaccessible appliances or built-in fixtures (i.e. trim, decorative panels, flooring, cabinetry, islands, countertops, drywall, etc.) that interfere with servicing, removal or replacement of the product.
15. Service or parts for appliances with original model/serial numbers removed, altered or not easily determined.

The cost of repair or replacement under these excluded circumstances shall be borne by the customer.

DISCLAIMER OF IMPLIED WARRANTIES

IMPLIED WARRANTIES, INCLUDING ANY IMPLIED WARRANTY OF MERCHANTABILITY OR IMPLIED WARRANTY OF FITNESS FOR A PARTICULAR PURPOSE, ARE LIMITED TO ONE YEAR OR THE SHORTEST PERIOD ALLOWED BY LAW. Some states and provinces do not allow limitations on the duration of implied warranties of merchantability or fitness, so this limitation may not apply to you. This warranty gives you specific legal rights, and you also may have other rights that vary from state to state or province to province.

DISCLAIMER OF REPRESENTATIONS OUTSIDE OF WARRANTY

Amana makes no representations about the quality, durability, or need for service or repair of this major appliance other than the representations contained in this warranty. If you want a longer or more comprehensive warranty than the limited warranty that comes with this major appliance, you should ask Amana or your retailer about buying an extended warranty.

LIMITATION OF REMEDIES; EXCLUSION OF INCIDENTAL AND CONSEQUENTIAL DAMAGES

YOUR SOLE AND EXCLUSIVE REMEDY UNDER THIS LIMITED WARRANTY SHALL BE PRODUCT REPAIR AS PROVIDED HEREIN. AMANA SHALL NOT BE LIABLE FOR INCIDENTAL OR CONSEQUENTIAL DAMAGES. Some states and provinces do not allow the exclusion or limitation of incidental or consequential damages, so these limitations and exclusions may not apply to you. This warranty gives you specific legal rights, and you also may have other rights that vary from state to state or province to province.

