

Panasonic®

Operating Instructions

Cordless Phone

Model No. **KX-TGD862**
KX-TGD863
KX-TGD864

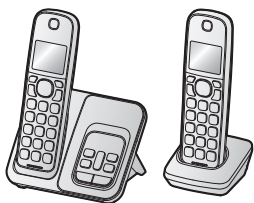

Model shown is KX-TGD862.

***Before initial use, see “Getting Started”
on page 11.***

Thank you for purchasing a Panasonic product.

Please read these operating instructions before using the unit and save them for future reference.

Consulte “Guía Rápida Española”, página 86.

For assistance, visit our Web site: <http://shop.panasonic.com/support> for customers in the U.S.A.

Please register your product: <http://shop.panasonic.com/support>

Table of Contents

Introduction		Programming	
Model composition	3	Menu list	40
Accessory information	3	Alarm	48
Graphical symbols for use on equipment and their descriptions	6	Silent mode	49
		Baby monitor	49
		Other programming	51
		Registering a unit	51
Important Information		Caller ID Service	
For your safety	7	Using Caller ID service	53
Important safety instructions	8	Caller list	53
For best performance	9		
Other information	9	Using Bluetooth® Devices	
Specifications	10	Copying phonebook from a cellular phone (phonebook transfer)	56
Getting Started		Link to Cell app	57
Setting up	11	Text message (SMS) alert	58
Controls	13	Alert settings for your DECT phone	58
Display icons/indicators	14	Remote voice assist	58
Language settings	16	Using a Bluetooth headset (optional)	59
Date and time	16		
Recording your greeting message	16	Answering System for Landline	
Other settings	16	Answering system for landline	62
		Turning the answering system on/off	62
Link to Cell		Greeting message	62
Link to cell feature	18	Listening to messages	63
Pairing a cellular phone	18	Advanced new message alerting features	64
Link to cell settings	19	Remote operation	66
		Answering system settings	67
Making/Answering Calls		Useful Information	
Making cellular calls	22	Voicemail service for landline	68
Making landline calls	22	Wall mounting	69
Answering calls	23	Error messages	72
Useful features during a call	23	Troubleshooting	73
Intercom	26	FCC and other information	83
		Guía Rápida Española	
Answer by Voice Command		Guía Rápida Española	86
Answer by voice command	28		
Call Block		Appendix	
Call block	29	Customer services	96
Storing unwanted callers	29	Limited Warranty (ONLY FOR U.S.A.)	97
		Index	
Enhanced Call Block		Index.....	99
Automated call block	32		
Telemarketing call block	34		
One ring scam alert	34		
Phonebook			
Phonebook	36		
Speed dial	38		

Model composition

Series	Model No.	Base unit	Handset	
		Part No.	Part No.	Quantity
KX-TGD860 series	KX-TGD862	KX-TGD860	KX-TGDA86	2
	KX-TGD863	KX-TGD860	KX-TGDA86	3
	KX-TGD864	KX-TGD860	KX-TGDA86	4

Accessory information

Supplied accessories

No.	Accessory item/ Part number	Quantity		
		KX-TGD862	KX-TGD863	KX-TGD864
①	AC adaptor*1	1	1	1
②	Telephone line cord*2	1	1	1
③	Wall mounting adaptor*3	1	1	1
④	Rechargeable batteries*4	4	6	8
⑤	Handset cover*5, *6	2	3	4
⑥	Charger*7	1	2	3

*1 PNLV226-0P or PNLV226-0R or PNLV226-0X

*2 PNJA1186Z (Black cord), PNJA1193Z (Transparent cord)

*3 PNKL1044Y2 (Black), PNKL1044Y1 (White)

*4 See page 4 for replacement battery information.

*5 The handset cover comes attached to the handset.

*6 PNYNTGDA83MR (Black), PNYNTGDA83WR (White)

*7 PNLC1077ZB (Black), PNLC1077ZW (White)

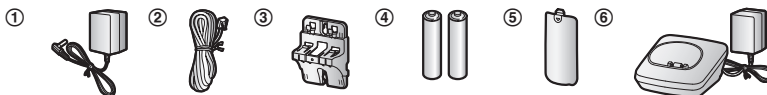

Introduction

Additional/replacement accessories

Please contact your nearest Panasonic dealer for sales information (page 96).

Accessory item	Model number/Specifications
Rechargeable batteries	HHR-4DPA*1 ● To order, please visit http://shop.panasonic.com/support
	Battery type: – Nickel metal hydride (Ni-MH) – 2 x AAA (R03) size for each handset
Range extender	KX-TGA407*2
Key detector	KX-TGA20*3

- *1 Replacement batteries may have a different capacity from that of the supplied batteries.
*2 By installing this unit, you can extend the range of your phone system to include areas where reception was previously not available. This product can be purchased online. Please visit our Web site: <http://shop.panasonic.com/support>
*3 By registering the key detector (4 max.) to a Panasonic Digital Cordless Phone and attaching it to an easy-to-lose item in advance, you can locate and find the mislaid item to which the key detector is attached. Please visit our Web site: <http://www.panasonic.com/tga20>

Other information

- Design and specifications are subject to change without notice.
- The illustrations in these instructions may vary slightly from the actual product.



Expanding your phone system

Handset (optional): KX-TGDA83/KX-TGDA86	
<p>You can expand your phone system by registering optional handsets (6 max.) to a single base unit.</p> <ul style="list-style-type: none">● Optional handsets may be a different color from that of the supplied handsets.● Optional handsets (KX-TGDA83) have a different key print from that of the supplied handsets.● To order, please visit http://shop.panasonic.com/support	

Introduction

Bluetooth® devices

You can expand your phone system by pairing the following units to a single base unit.

Your Bluetooth cellular phone*1: 2 max. (for cellular calls: page 18)	
Your Bluetooth headset*1: 1 max. (for a wireless hands-free conversation: page 59)	













*1 Your cellular phone and headset must be Bluetooth wireless technology compatible. For more details and the list of compatible cellular phones, please visit our Web site: <http://shop.panasonic.com/bluetooth-phone>

Trademarks

- The Bluetooth® word mark and logos are registered trademarks owned by Bluetooth SIG, Inc. and any use of such marks by Panasonic Corporation is under license.
- iPhone and Siri are registered trademarks of Apple Inc.
- Android, Gmail, Google Calendar and Google Assistant are trademarks of Google LLC.
- Facebook and Instagram are trademarks of Facebook, Inc.
- Twitter is a trademark of Twitter, Inc.
- All other trademarks identified herein are the property of their respective owners.

Introduction

Graphical symbols for use on equipment and their descriptions

Symbol	Explanation	Symbol	Explanation
	Alternating current (A.C.)		Class II equipment (equipment in which protection against electric shock relies on Double Insulation or Reinforced Insulation)
	Direct current (D.C.)		"ON" (power)
	Protective earth		"OFF" (power)
	Protective bonding earth		Stand-by (power)
	Caution, risk caused by visible radiation		"ON"/"OFF" (power; push-push)
	For indoor use only		Caution, risk of electric shock

Important Information

For your safety

To prevent severe injury and loss of life/property, read this section carefully before using the product to ensure proper and safe operation of your product.

WARNING

Power connection

- Use only the power source marked on the product.
- Do not overload power outlets and extension cords. This can result in the risk of fire or electric shock.
- Completely insert the AC adaptor/power plug into the power outlet. Failure to do so may cause electric shock and/or excessive heat resulting in a fire.
- Regularly remove any dust, etc. from the AC adaptor/power plug by pulling it from the power outlet, then wiping with a dry cloth. Accumulated dust may cause an insulation defect from moisture, etc. resulting in a fire.
- Unplug the product from power outlets if it emits smoke, an abnormal smell, or makes an unusual noise. These conditions can cause fire or electric shock. Confirm that smoke has stopped emitting and contact us at <http://shop.panasonic.com/support>
- Unplug from power outlets and never touch the inside of the product if its casing has been broken open.
- Never touch the plug with wet hands. Danger of electric shock exists.

Installation

- To prevent the risk of fire or electrical shock, do not expose the product to rain or any type of moisture.
- Do not place or use this product near automatically controlled devices such as automatic doors and fire alarms. Radio waves emitted from this product may cause such devices to malfunction resulting in an accident.

- Do not allow the AC adaptor or telephone line cord to be excessively pulled, bent or placed under heavy objects.
- Do not place the handset on the base unit when battery cover is removed.

Operating safeguards

- Unplug the product from power outlets before cleaning. Do not use liquid or aerosol cleaners.
- Do not disassemble the product.
- Do not spill liquids (detergents, cleansers, etc.) onto the telephone line cord plug, or allow it to become wet at all. This may cause a fire. If the telephone line cord plug becomes wet, immediately pull it from the telephone wall jack, and do not use.

Medical

- Consult the manufacturer of any personal medical devices, such as pacemakers or hearing aids, to determine if they are adequately shielded from external RF (radio frequency) energy. (The product operates in the frequency range of 1.92 GHz to 1.93 GHz, and the RF transmission power is 115 mW (max..))
- Do not use the product in health care facilities if any regulations posted in the area instruct you not to do so. Hospitals or health care facilities may be using equipment that could be sensitive to external RF energy.

CAUTION

Installation and location

- Never install telephone wiring during an electrical storm.
- Never install telephone line jacks in wet locations unless the jack is specifically designed for wet locations.
- Never touch uninsulated telephone wires or terminals unless the telephone line has been disconnected at the network interface.
- Use caution when installing or modifying telephone lines.
- The AC adaptor is used as the main disconnect device. Ensure that the AC

For assistance, please visit <http://shop.panasonic.com/support>

7

Important Information

outlet is installed near the product and is easily accessible.

- The product is only use for mounting at heights ≤ 2 m.

Note:

- This height is not guaranteed for product reliability.
- To prevent serious injuries due to the product unexpectedly falling, the product must be installed at a height of 1.5 m or lower.
- This product is unable to make calls when:
 - the handset batteries need recharging or have failed.
 - there is a power failure.

Battery

- We recommend using the batteries noted on page 4. **USE ONLY rechargeable Ni-MH batteries AAA (R03) size.**
- Do not mix old and new batteries.
- Do not open or mutilate the batteries. Released electrolyte from the batteries is corrosive and may cause burns or injury to the eyes or skin. The electrolyte is toxic and may be harmful if swallowed.
- Exercise care when handling the batteries. Do not allow conductive materials such as rings, bracelets, or keys to touch the batteries, otherwise a short circuit may cause the batteries and/or the conductive material to overheat and cause burns.
- Charge the batteries provided with or identified for use with this product only, in accordance with the instructions and limitations specified in this manual.
- Only use a compatible base unit (or charger) to charge the batteries. Do not tamper with the base unit (or charger). Failure to follow these instructions may cause the batteries to swell or explode.
- Avoid the use in the following conditions
 - High or low extreme temperatures during use, storage or transportation.
 - Replacement of a battery with an incorrect type that can defeat a safeguard.
 - Disposal of a battery into fire or a hot oven, or mechanically crushing or cutting

of a battery, that can result in an explosion.

- Extremely high temperature and/or extremely low air pressure that can result in an explosion or the leakage of flammable liquid or gas.

Attention:



A nickel metal hydride battery that is recyclable powers the product you have purchased.

Please call 1-800-8-BATTERY (1-800-822-8837) for information on how to recycle this battery.

Important safety instructions

When using your product, basic safety precautions should always be followed to reduce the risk of fire, electric shock, and injury to persons, including the following:

1. Do not use this product near water for example, near a bathtub, washbowl, kitchen sink, or laundry tub, in a wet basement or near a swimming pool.
2. Avoid using a telephone (other than a cordless type) during an electrical storm. There may be a remote risk of electric shock from lightning.
3. Do not use the telephone to report a gas leak in the vicinity of the leak.
4. Use only the power cord and batteries indicated in this manual. Do not dispose of batteries in a fire. They may explode. Check with local codes for possible special disposal instructions.

SAVE THESE INSTRUCTIONS

Important Information

For best performance

Base unit location/avoiding noise

The base unit and other compatible Panasonic units use radio waves to communicate with each other.

- For maximum coverage and noise-free communications, place your base unit:
 - at a convenient, high, and central location with no obstructions between the handset and base unit in an indoor environment.
 - away from electronic appliances such as TVs, radios, personal computers, wireless devices, or other phones.
 - facing away from radio frequency transmitters, such as external antennas of mobile phone cell stations. (Avoid putting the base unit on a bay window or near a window.)
- Coverage and voice quality depends on the local environmental conditions.
- If the reception for a base unit location is not satisfactory, move the base unit to another location for better reception.

Environment

- Keep the product away from electrical noise generating devices, such as fluorescent lamps and motors.
- The product should be kept free from excessive smoke, dust, high temperature, and vibration.
- The product should not be exposed to direct sunlight.
- Do not place heavy objects on top of the product.
- When you leave the product unused for a long period of time, unplug the product from the power outlet.
- The product should be kept away from heat sources such as heating devices, cooking appliances, etc. It should not be placed in rooms where the temperature is less than 0 °C (32 °F) or greater than 40 °C (104 °F). Damp basements should also be avoided.
- The maximum calling distance may be shortened when the product is used in the following places: Near obstacles such as

hills, tunnels, underground, near metal objects such as wire fences, etc.

- Operating the product near electrical appliances may cause interference. Move away from the electrical appliances.

Routine care

- **Wipe the outer surface of the product with a soft moist cloth.**
- Do not use benzene, thinner, or any abrasive powder.

Other information

- The applied nameplate is located at the bottom or rear of the product.
- **⚠ CAUTION:** Risk of explosion if battery is replaced by an incorrect type. Dispose of used batteries according to the instructions.

Notice for product disposal, transfer, or return

- This product can store your private/confidential information. To protect your privacy/confidentiality, we recommend that you erase information such as phonebook or caller list entries from the memory before you dispose of, transfer, or return the product.

For assistance, please visit <http://shop.panasonic.com/support>

9

Important Information

Notice

- This product is designed for use in the United States of America. Sale or use of this product in other countries may violate local laws.
- Cet appareil est conçu pour être utilisé aux États-Unis d'Amérique. La vente ou l'emploi de cet appareil dans certains autres pays peut constituer une infraction à la législation locale.
- Este producto está diseñado para usarse en los Estados Unidos de América. La venta o el empleo de este producto en ciertos países puede constituir violación de la legislación local.
- 本產品專為美國使用而設。若在其他國家銷售或使用，可能會違反當地法例。
- この製品は、日本国外での使用を目的として設計されており、日本国内での使用は法律違反となります。従って、当社では日本国内においては原則として修理などのサービスは致しかねます。

Specifications

- **Standard:**
 - Bluetooth wireless technology 4.2
 - Hands Free Profile (HFP)
 - Headset Profile (HSP)
 - Phone Book Access Profile (PBAP)
 - Object Push Profile (OPP)
 - Serial Port Profile (SPP)
 - Message Access Profile (MAP)
- **Frequency range:**
 - 1.92 GHz to 1.93 GHz (DECT)
 - 2.402 GHz to 2.48 GHz (Bluetooth)
- **RF transmission power:**
 - 115 mW (max.)
- **Power source:**
 - 120 V AC, 60 Hz
- **Power consumption:**
 - Base unit:**
 - Standby: 1.2 W
 - Maximum: 4.5 W
 - Charger:**
 - Standby: 0.1 W
 - Maximum: 1.8 W
- **Operating conditions:**
 - 0 °C – 40 °C (32 °F – 104 °F), 20 % – 80 % relative air humidity (dry)

Setting up

Connections

- If you do not connect the telephone line cord and use only cellular lines, set the cellular line only mode to use this unit more conveniently (page 20).

■ Base unit

- ① Connect the AC adaptor to the unit by pressing the plug firmly.
- ② Connect the AC adaptor to the power outlet.
- ③ Connect the telephone line cord to the unit, then to the single-line telephone jack (RJ11C) until you hear a click.
- ④ A DSL/ADSL filter (not supplied) is required if you have a DSL/ADSL service.

Note:

- Use only the supplied Panasonic AC adaptor PNLV226.

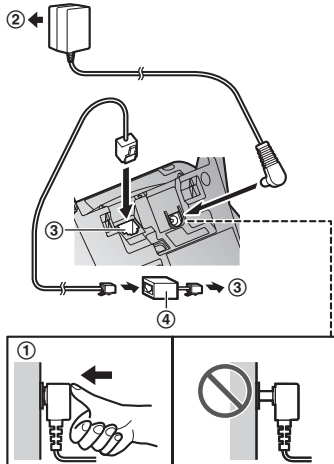

■ Charger

- ① Connect the AC adaptor to the power outlet.

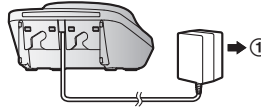

Battery installation

- USE ONLY rechargeable Ni-MH batteries AAA (R03) size (A).
- Do NOT use alkaline/manganese/Ni-Cd batteries.
- Confirm correct polarities (+, -).

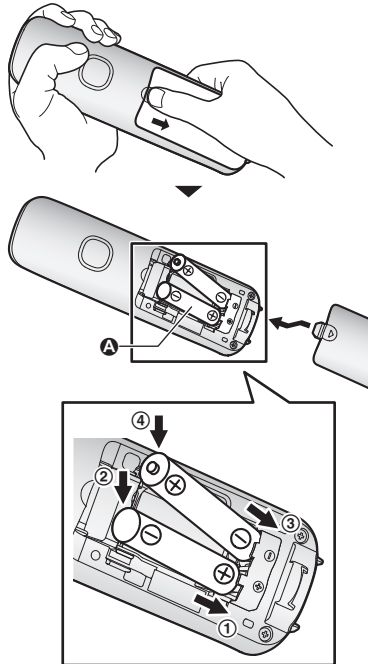

- Follow the directions on the display to set up the unit.

Getting Started

Removing the battery

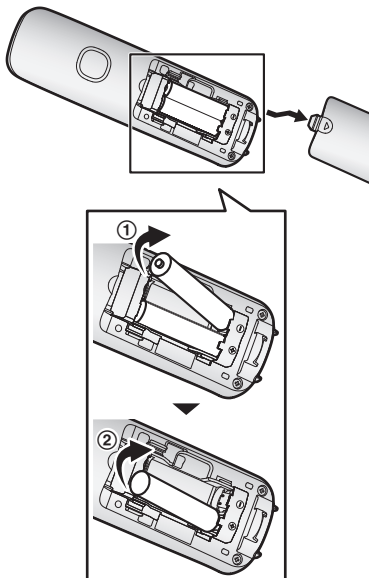

Battery charging

Charge for about 7 hours.

- Confirm “Charging” is displayed (A).
- When the batteries are fully charged, “Fully charged” is displayed.

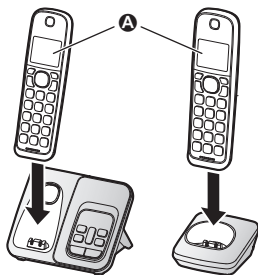

Note when setting up

Note for connections

- The AC adaptor must remain connected at all times. (It is normal for the adaptor to feel warm during use.)
- The AC adaptor should be connected to a vertically oriented or floor-mounted AC outlet. Do not connect the AC adaptor to a horizontally oriented AC outlet that faces the floor, such as an AC outlet installed on a ceiling or under a table, as the weight of the adaptor may cause it to become disconnected.

Power failure

- The unit cannot be used to make or receive calls during a power failure. We recommend connecting a corded-type telephone that does not use an AC adaptor to your telephone line.

Note for battery installation

- Use the supplied rechargeable batteries. For replacement, we recommend using the Panasonic rechargeable batteries noted on page 4, 8.

Note for battery charging

- It is normal for the handset to feel warm during charging.
- Clean the charge contacts of the handset, base unit, and charger with a soft and dry cloth once a month. Before cleaning the unit, disconnect from power outlets and any telephone line cords. Clean more often if the unit is exposed to grease, dust, or high humidity.

Battery level

Icon	Battery level
	High
	Medium
	Low
	Needs charging.

Icon	Battery level
	Empty

Note:

- At the end of each call, the unit displays a large icon for a few moments to indicate the battery level.
- You can set the unit to play a voice announcement when the battery is low or needs charging. (page 17)

Ni-MH battery performance (supplied batteries)

Operation	Operating time
In continuous use	10 hours max.*1
Not in use (standby)	5 days max.*1

*1 If eco mode is on except when using link to cell function.

Note:

- Actual battery performance depends on usage and ambient environment.

Intelligent eco mode

This feature automatically reduces handset power consumption by suppressing handset transmission power when the handset is close to the base unit.

- When this feature is activated, is displayed.
- Even though this feature is activated, is not displayed:
 - during a cellular call.
 - when answer by voice command is turned on (page 28).

Controls

Handset

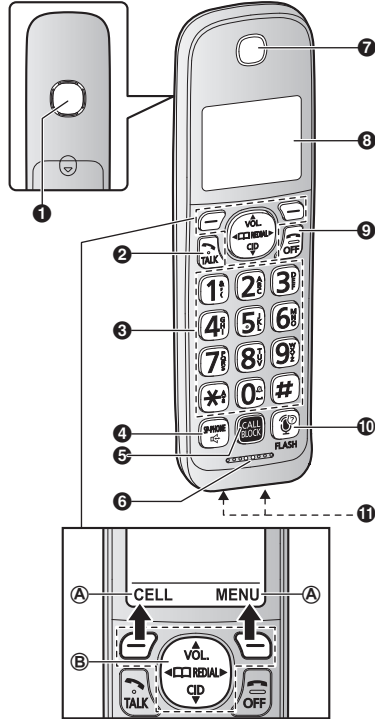

- 1 Speaker
- 2 (TALK)
- 3 Dial keypad
: Temporary tone dialing
: (X) Ringer off
- 4 (SP-PHONE: Speakerphone)
- 5 [CALL BLOCK]
- 6 Microphone
- 7 Receiver
- 8 Display
- 9 [OFF]

For assistance, please visit <http://shop.panasonic.com/support>

Getting Started

- 10 [] (Assist) [FLASH]
- You can use the handset to operate the voice recognition feature of your cellular phone by pressing [] (page 58).

11 Charge contacts

■ Control type

(A) Soft keys

By pressing a soft key, you can select the feature shown directly above it on the display. After a cellular phone is paired, [CELL] is displayed.

(B) Navigator key

- [▲], [▼], [◀], or [▶]: Scroll through various lists and items.
- VOL. (Volume: [▲] or [▼]): Adjust the receiver or speaker volume while talking.
- [◀] □: View the phonebook entry.
- [▶] REDIAL: View the redial list.
- [▼] CID (Caller ID): View the caller list.

Base unit

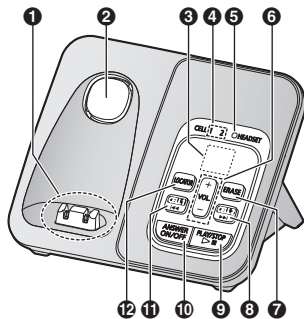













- 1 Charge contacts
- 2 Speaker
- 3 Message counter
- 4 CELL 1 indicator
- 5 CELL 2 indicator
- 6 HEADSET indicator
- 7 [+]/[-] (VOL.: Volume up/down) [ERASE]
- 8 [CELL 2] (For pairing) [▶▶] (Skip) [▶■] (PLAY/STOP)
- 9 Message indicator (▶)

- 10 [ANSWER ON/OFF]
- 11 [CELL 1] (For pairing)
- 12 [◀◀] (Repeat) [LOCATOR]
- You can locate a misplaced handset by pressing [LOCATOR].

Display icons/Indicators

Handset display items

Item	Meaning
	Within base unit range
	Out of base unit range
	The landline is in use. <ul style="list-style-type: none"> When flashing slowly: The call is on hold. When flashing rapidly: An incoming call is now being received.
	<ul style="list-style-type: none"> A cellular line is in use.*1 <ul style="list-style-type: none"> When flashing slowly: The cellular call is on hold. When flashing rapidly: A cellular call or text message is being received. The remote voice assist feature is in use*1.
	Eco mode is on.*2 (page 13)
	<ul style="list-style-type: none"> A cellular phone is connected.*1 Ready to make/receive cellular calls. <ul style="list-style-type: none"> When turned off: A cellular phone is not connected to the base unit. (page 20)
	<ul style="list-style-type: none"> A cellular call is in progress on that line. The cellular line is selected for the setting.
	Noise reduction is set. (page 24)
	Equalizer is set. (page 24)

Item	Meaning
	Speakerphone is on. (page 22)
	Ringer volume is off.*3 (page 23, 42, 44)
	Silent mode is on. (page 49)
	Call sharing mode is off. (page 46)
	Alarm is on. (page 48)
	Handset number
	Battery level
	Answer by voice command is on. (page 28)
	Blocked call (page 29)
	Automated call block is set to "Block". (page 32)
	Blocked automated call (page 54)
	Scam call (page 54)
	Baby monitor is activated. The name/number displayed next to the icon indicates the monitoring unit. (page 49)
In use	Answering system is being used by another unit.
Cell11 in use	Someone is using the corresponding line.
Cell12 in use	
Line in use	

- *1 Corresponding lines (1, 2: cellular line) are indicated next to the item.
- *2 During a cellular call, the item is not displayed even though the feature is activated.
- *3 Corresponding lines (1, 2: cellular line, L: landline) are indicated next to the item. If all lines are turned off, no line is indicated.

Base unit display item

Item	Meaning
	"Greeting only" is selected. Caller messages are not recorded. (page 67)

CELL indicators on the base unit

The CELL indicators show each cellular line status.

Status	Meaning
On	A cellular phone is connected. Ready to make/receive cellular calls.
Flashing slowly	<ul style="list-style-type: none"> – The cellular line is in use. – Phonebook entries are being copied from a cellular phone (page 56). – The base unit is searching for the paired cellular phone. – The base unit is pairing a cellular phone. – A cellular call is on hold. – The remote voice assist feature is in use (page 58).
Flashing rapidly	A cellular call or text message is being received.
Light off	<ul style="list-style-type: none"> – A cellular phone is not paired to the base unit. – A cellular phone is not connected to the base unit (page 20).

Bluetooth HEADSET indicator on the base unit

The HEADSET indicator shows the Bluetooth headset status.

Status	Meaning
On	A Bluetooth headset is connected to the base unit. Ready to use it.

Getting Started

Status	Meaning
Flashing slowly	<ul style="list-style-type: none">– A Bluetooth headset is in use.– The base unit is searching for the paired Bluetooth headset.– The base unit is pairing a headset.
Flashing rapidly	A landline call is being received.
Light off	<ul style="list-style-type: none">– A Bluetooth headset is not paired to the base unit.– The Bluetooth headset is not connected to the base unit.

Language settings

Display language

- 1 **[MENU]** **#** **1** **1** **0**
- 2 **[↓]**: Select the desired setting. → **[SAVE]** → **[OFF]**

Note:

- The language selected will also be used for the low battery alert announcement (page 17).

Voice announcement language

You can select the language used for the following features.

- Answering system guidance
- Automated call block guidance
- Telemarketing call block guidance
- Talking Caller ID
- Answer by voice command announcement
- 2-way recording announcement
- Application (App) alert announcement
- Text message (SMS) alert announcement

- 1 **[MENU]** **#** **1** **1** **2**
- 2 **[↓]**: Select the desired setting. → **[SAVE]** → **[OFF]**

Date and time

- 1 **[MENU]** **#** **1** **0** **1**
- 2 Enter the current month, date, and year by selecting 2 digits for each.
Example: July 12, 2021
0 **7** **1** **2** **2** **1**
- 3 **[OK]**
- 4 Enter the current hour and minute (12-hour clock format) by selecting 2 digits for each.
Example: 9:30
0 **9** **3** **0**
- 5 **[X]**: Select **"AM"** or **"PM"**.
- 6 **[SAVE]** → **[OFF]**

Note:

- When English is selected as the display language, 12-hour clock format is used. When Spanish is selected, 24-hour clock format is used.

Recording your greeting message

You can record your own greeting message instead of using a pre-recorded greeting message. See page 62 for details.

- 1 **[MENU]** **#** **3** **0** **2**
- 2 **[↓]**: **"Yes"** → **[SELECT]**
- 3 Record a greeting message. → **[STOP]** → **[OFF]**

Other settings

Dialing mode

If you cannot make calls, change this setting according to your telephone line service. The default setting is **"Tone"**.

"Tone": For tone dial service.

"Pulse": For rotary/pulse dial service.

- 1 **[MENU]** **#** **1** **2** **0**

- 2 **[↕]**: Select the desired setting. →
[SAVE] → [OFF]

Low battery alert

This feature plays a voice announcement when the handset battery is low or needs charging.

When this feature is turned on, the unit notifies you as follows.

- **When you end a call:**
 - The unit plays a voice announcement when the battery is low or needs charging.
- **When the handset is in standby mode:**
 - If the battery is low or needs charging, the unit plays a voice announcement at the selected interval up to 3 times.

Note for handset:

- At the end of each call, the unit displays a large icon for a few moments to indicate the battery level.

Setting low battery alert

To turn this feature on, select the desired announcement interval, or select “**OFF**” to turn this feature off. The default setting is “**Every hour**”.

- 1 **[MENU]#176**
- 2 **[↕]**: Select the desired setting. →
[SAVE] → [OFF]

Link to Cell

Link to cell feature

You can connect your base unit and cellular phone using Bluetooth wireless technology, so that you can make or answer cellular calls using your phone system. This allows you to:

- use the unit to talk on cellular calls even if some areas of your home have poor cellular reception, simply by placing your cellular phone in an area with good reception.
- talk on cellular calls even if your cellular phone is in your pocket or bag.
- enjoy cordless cellular calls even if your cellular phone plugged in and charging.

Important:

- Your cellular phone must support the Hands Free Profile (HFP) specification.
- You may pair 2 cellular phones and 1 Bluetooth headset.
- The unit cannot be used to talk on 2 cellular lines at the same time.
- Only 1 Bluetooth device can be used with the unit at a time*1.
- Locate your cellular phone near the base unit. If the cellular phone is too close to the base unit during a cellular call, you may hear noise. For best performance, we recommend placing the cellular phone between 0.6 m to 3 m (2 feet to 10 feet) away from the base unit.

*1 You cannot use a Bluetooth headset to talk on a cellular line.

Pairing a cellular phone

Important:

- For more details and the list of compatible cellular phones, please visit our Web site: <http://shop.panasonic.com/bluetooth-phone>
- Before pairing a Bluetooth enabled cellular phone to the base unit, make sure that no other Bluetooth device such as a Bluetooth headset is connected to your cellular phone.

- 1 Base unit:**
Press and hold [CELL 1] or [CELL 2] for about 5 seconds.

- 2 Your cellular phone:**
While the corresponding CELL indicator is flashing, follow the instructions of your cellular phone to enter the pairing mode.
 - Depending on your cellular phone, it may ask you to enter the Bluetooth PIN (default: "0000"). If your cellular phone shows PassKey confirmation on its display, follow the directions to proceed.
- 3 Base unit:**
Wait until a long beep sounds.
 - It may take more than 10 seconds to complete pairing.
 - When the corresponding CELL indicator lights up, the cellular phone is connected to the base unit. You are ready to make cellular calls.

Note:

- If the cellular phone has already paired to the base unit, it is overwritten.
- Make sure that your cellular phone is set to connect to this product automatically. Refer to your cellular phone's operating instructions.
- Make sure you cancel your cellular phone's current pairing if you want to pair it to the other line (page 18).
- The default setting for the alert feature is "On", so when you pair your cellular phone to the base unit, this feature may be activated (page 58). (This depends on the version and type of cellular phone you are using.)

Unpairing a cellular phone

You can cancel the pairing of a cellular phone that is stored in the base unit.

- 1** For CELL 1: [MENU] # 6 1 1 1
For CELL 2: [MENU] # 6 1 1 2
- 2** [↕]: "Yes" → [SELECT]
 - When the cellular phone is unpaired, the CELL indicator is turned off.

3 [OFF]

Link to cell settings

Selecting which unit receives cellular calls

You can select which unit rings and receives calls for a cellular line. When "All" is selected, all handsets and the base unit ring.

- 1 For CELL 1: **[MENU]#6271**
For CELL 2: **[MENU]#6272**
- 2 **[↕]**: Select the desired handset or "All".
→ **[SAVE] → [OFF]**

Note:

- When you select a specific handset to receive calls for a cellular line other handsets cannot answer the calls.
- When you change to "All" from another setting, the base unit ringer volume also returns to the lowest level even if the ringer volume was changed.
- The units selected with this setting have the alert feature (page 58) applied to them.

Ring as cell mode

Once this feature is turned on, the handset and base unit ring using the same ringer tone as your cellular phone.

The following settings are available:

- "Off": Turn this feature off to use the ringer tones of the handset and base unit. Caller information is announced depending on the Talking Caller ID setting (page 44).
- "On (with Talking CID)" (default): The handset and base unit use your cellular phone's ringer tone. Caller information is announced even if the Talking Caller ID is turned off.
- "On (without Talking CID)": The handset and base unit use your cellular phone's ringer tone. Caller information is not announced even if the Talking Caller ID is turned on.

Important:

- To use this feature, your cellular phone must support Bluetooth in-band ringtone. Refer to your cellular phone's operating instructions.

- 1 For CELL 1: **[MENU]#6141**
For CELL 2: **[MENU]#6142**
- 2 **[↕]**: Select the desired setting. →
[SAVE] → [OFF]

Note:

- The units use the preset ringer tones instead of your cellular phone's ringer tone when a cellular call is being received if:
 - your cellular phone is in silent mode (depending on your cellular phone).
 - 2 handsets are sharing a landline call.
 - answer by voice command feature is turned on (page 28).
- If your cellular phone is in silent mode with "On (with Talking CID)" set, the unit announces caller information even when Talking Caller ID is turned off (page 44).
- When ring as cell mode is set to on, the ringer volume depends on the cellular phone Bluetooth output level specification. If the ringer volume in this mode is low, turn this feature off to use the ringer tones of the handset and base unit.

To use the handset ringer tone instead of your cellular phone's ringer tone

Select "off" in step 2, "Ring as cell mode", page 19.

To change the handset ringer tone for a cellular line, see page 42.

Auto connection to the Bluetooth devices (cellular phones)

After pairing, your Bluetooth devices are connected to the base unit. If you move the Bluetooth devices out of base unit range, the Bluetooth devices are disconnected from the base unit. This feature allows the base unit to try to reconnect the Bluetooth devices at regular intervals when it returns within base

Link to Cell

unit range. You can set the interval. The default setting is "1 min".

Important:

- Only 1 Bluetooth device can be used with the unit at a time, and the base unit loses its connection from other Bluetooth devices. To automatically resume the connection to Bluetooth devices, leave the auto connection on.
- Some cellular phones lose connection after usage, please check the specifications of your cellular phone for more details.

- 1 **[MENU]** **[#]** **[6]** **[3]** **[2]**
- 2 **[↕]**: Select the desired setting. → **[SAVE]** → **[OFF]**

Note:

- Some cellular phones may ask you if you accept the connection requirement from the base unit. In that case, select "Off" in step 2. Check the specifications of your cellular phone.

Connecting/disconnecting the cellular phone manually

If you will not be using the paired cellular phone's link to cell feature temporarily (for example, you do not want the unit to ring when your cellular line receives a call), you can disconnect your cellular phone from the base unit. If you want to use it again, reconnect the cellular phone to the base unit.

Note:

- After you disconnect a paired cellular phone from the base unit manually, it will automatically be connected to the base unit in 30 minutes. If you do not use the link to cell feature anymore, unpair the cellular phone (page 18).
- A disconnected cellular phone is not unpaired from the base unit, so pairing it to the base unit again is unnecessary.

- 1 **To connect/disconnect:**
For CELL 1: **[MENU]** **[#]** **[6]** **[2]** **[5]** **[1]**
For CELL 2: **[MENU]** **[#]** **[6]** **[2]** **[5]** **[2]**
 - A long beep sounds.
- 2 **[OFF]**

Cellular line only mode (If you do not use the landline)

If you do not use the landline, we recommend setting the unit to the cellular line only mode. The default setting is "Off".

Important:

- If you turn on the "Cell line only mode", disconnect the telephone line cord from the base unit. Otherwise the "Cell line only mode" cannot be activated.

- 1 **[MENU]** **[#]** **[1]** **[5]** **[7]**
- 2 **To turn on:**
[↕]: "On" → **[SELECT]** → **[↕]**: "Yes" → **[SELECT]**
To turn off:
[↕]: "Off" → **[SELECT]**

Note:

- Once you set this mode, you can press **[↶]** or **[↷]** instead of **[CELL]** (page 22) to make cellular calls for the handset.
- Once you set this mode, the following features cannot be used:
 - Landline features (Incoming ringer volume, incoming ringer tone, dial mode, flash time, and line mode)
 - Answering system (page 62)
Messages cannot be received.
 - Voicemail features (page 68)
- After this mode is turned on or off, the base unit reboots.
 - Bluetooth connections from cellular phones or Bluetooth headset are disconnected. If the auto connection is turned on (page 19), the cellular phones are reconnected.
 - **Y** will be displayed on the handset momentarily. The handset can be used once **Y** is displayed.

When you use the landline again

Before connecting the telephone line to the base unit, select "Off" in step 2, "Cellular line only mode (If you do not use the landline)", page 20.

Cellular line selection

This feature determines which cellular line is selected to make cellular calls when:

- you press **[CELL]** on the handset.
- you press **[↶]** or **[↷]** on the handset while the cellular line only mode is turned on.

The following settings are available:

- “**Manual**” (default): You can select the desired cellular line when making a call.
- “**Cellphone 1**”^{*1}: CELL 1 is selected.
- “**Cellphone 2**”^{*1}: CELL 2 is selected.

1 **[MENU]****[#]****[6]****[3]****[4]**

2 **[↕]**: Select the desired setting. →
[SAVE] → **[OFF]**

*1 After the Bluetooth device is paired, the device name is displayed.

Storing your area code (for dialing only a 7-digit phone number to make a local call)

You need to add your area code when making cellular calls to a phone number in your area. Once you store your area code, it is automatically added to the beginning of the 7-digit phone number when making cellular calls.

1 **[MENU]****[#]****[6]****[3]****[3]**

2 Enter the 3-digit area code.
• To correct a digit, press **[CLEAR]**.

3 **[SAVE]** → **[OFF]**

Changing the Bluetooth PIN (Personal Identification Number)

The PIN is used to pair cellular phones to the base unit. The default PIN is “0000”. To prevent unauthorized access to this product, we recommend that you change the PIN, and keep it confidential.

Important:

- Please make note of your new PIN. The unit does not reveal the PIN to you. If you forget your PIN, see page 81.

1 **[MENU]****[#]****[6]****[1]****[9]**

- If the unit prompts you to enter the old PIN (when the default has been changed), enter the current 4-digit PIN. → **[OK]**

2 Enter the new 4-digit PIN. → **[OK]**

3 Enter the new 4-digit PIN again. →
[SAVE] → **[OFF]**

Making/Answering Calls

Making cellular calls

Important:

- The unit cannot be used to talk on 2 cellular lines at the same time.
- Only 1 Bluetooth device can be used with the unit at a time*1.
- Before making calls, confirm that the corresponding  on the handset is displayed (page 14).

*1 You cannot use a Bluetooth headset to talk on a cellular line.

- 1 Lift the handset and then dial the phone number.
 - To correct a digit, press **[CLEAR]**.
- 2 **[CELL]**
 - The unit starts dialing immediately in the following situations.
 - Only 1 cellular phone is paired.
 - A specific line is set to make cellular calls (page 21).
 - Go to step 4.
- 3 **[↕]**: Select the desired cellular phone. → **[SELECT]**
- 4 When you finish talking, press **[OFF]** or place the handset on the base unit or charger.

Note:

- To switch to the speaker, press **[📞]**. To switch back to the receiver, press **[📞]/[📞]**.
- In step 1, you can store the dialed phone number to the phonebook by pressing and holding **[←] □□** for a few seconds.

Adjusting the receiver or speaker volume

Press **[▲]** or **[▼]** repeatedly while talking.

Note:

- The receiver*1 or speaker volume you set is kept for each line (landline and cellular lines).

*1 If the receiver volume is set to level 5 (max.), it will be changed to level 4 in the next call.

Making a call using the redial list

The last 5 phone numbers dialed are stored in the redial list (48 digits max. each).

- 1 **[▶]** REDIAL
- 2 **[↕]**: Select the desired entry.
- 3 **[CELL]**
 - The unit starts dialing immediately in the following situations.
 - Only 1 cellular phone is paired.
 - A specific line is set to make cellular calls (page 21).
- 4 **[↕]**: Select the desired cellular phone. → **[SELECT]**

Erasing a number in the redial list

■ When a cellular phone is paired:

- 1 **[▶]** REDIAL
- 2 **[↕]**: Select the desired entry. → **[MENU]**
- 3 **[↕]**: “Erase” → **[SELECT]**
- 4 **[↕]**: “Yes” → **[SELECT]** → **[OFF]**

■ When a cellular phone is not paired:

- 1 **[▶]** REDIAL
- 2 **[↕]**: Select the desired entry. → **[ERASE]**
- 3 **[↕]**: “Yes” → **[SELECT]** → **[OFF]**

Making landline calls

- 1 Lift the handset and then dial the phone number.
 - To correct a digit, press **[CLEAR]**.
- 2 Press **[📞]** to make the call.
 - To make the call using the speakerphone, press **[📞]**.
- 3 When you finish talking, press **[OFF]** or place the handset on the base unit or charger.

Note:

- To switch to the speaker, press **[📞]**. To switch back to the receiver, press **[📞]/[📞]**.

- In step 1, you can store the dialed phone number to the phonebook by pressing and holding [↵] □□ for a few seconds.

Making a call using the redial list

The last 5 phone numbers dialed are stored in the redial list (48 digits max. each).

- 1 [▶] REDIAL
- 2 [↕]: Select the desired entry.
- 3 Press [↶] or [↷].

Pause (for PBX/long distance service users)

A pause is sometimes required when making calls using a PBX or long distance service. When storing a calling card access number and/or PIN in the phonebook, a pause is also needed (page 38).

Example: If you need to dial the line access number "9" when making outside calls with a PBX:

- 1 [9] → [▲] (Pause)
- 2 Dial the phone number. → [↶]

Note:

- A 3.5 second pause is inserted each time [▲] (Pause) is pressed.

Answering calls

- 1 Lift the handset and then press [↶] or [↷] when the unit rings.
 - To answer a cellular call, you can also press [CELL].
- 2 When you finish talking, press [OFF] or place the handset on the base unit or charger.

Any key answer: You can answer the call by pressing any dial key (except [0] key).

Auto talk: You can answer calls simply by lifting the handset (page 46).

Temporary handset ringer off: You can turn the ringer off temporarily by pressing [⏸] (left soft key).

Adjusting the ringer volume

Handset

Press [▲] or [▼] repeatedly to select the desired volume while ringing.

- To turn the ringer off, press [▼] repeatedly.

Base unit

■ While the base unit is ringing for an incoming call:

Press [+] or [-] repeatedly to select the desired volume.

■ While the base unit is in standby mode:

Press [+] or [-] repeatedly to select the desired volume for landline call.

- To turn the ringer off, press and hold [-] until the unit beeps.

Note for handset and base unit:

- You can adjust the ringer volume for cellular call and landline call by programming (page 42, 44).
- The ringer volume you set is kept for each line (landline and cellular lines).

One-touch ringer off for the handset

Press and hold [0] (⏸) until the unit beeps to turn the ringer off. While the ringer is turned off, the handset will not ring for cellular calls or for landline calls.

- You can turn the ringer on again by pressing and holding [0] (⏸) until the unit beeps.

Useful features during a call

Hold

- 1 Press [MENU] during an outside call.
 - 2 [↕]: "Hold" → [SELECT]
 - 3 **To release hold on the cellular line:** Press [CELL].*¹
 - Another handset user can take the call by pressing [CELL].*¹
- *¹ If you press [CELL] and the selection list is displayed, select

Making/Answering Calls

the desired cellular line and press **[SELECT]**.

To release hold on the landline:

Press **[]**.

- Another handset user can take the call by pressing **[]**.

Note:

- After holding for 10 minutes, the call is disconnected.

Mute

- 1 Press **[MUTE]** during a call.
- 2 To return to the call, press **[MUTE]**.

Note:

- **[MUTE]** is a soft key visible on the display during a call.

Flash for landline calls

[FLASH] allows you to use the special features of your host PBX such as transferring an extension call, or accessing optional telephone services.

Note:

- To change the flash time, see page 46.

For call waiting or Call Waiting Caller ID service users

To use call waiting or Call Waiting Caller ID, you must first subscribe with your phone service provider.

This feature allows you to receive calls while you are already talking on the phone. If you receive a call while on the phone, you will hear a call waiting tone.

If you subscribe to both Caller ID and Call Waiting with Caller ID services, the 2nd caller's information is displayed on the unit that is in use after you hear the call waiting tone.

- 1 Press **[FLASH]** to answer the 2nd call.
- 2 To switch between calls, press **[FLASH]**.

Note:

- Please contact your phone service provider for details and availability of this service in your area.

Temporary tone dialing for landline calls (for rotary/pulse service users)

Press **[]** before entering access numbers which require tone dialing.

Handset noise reduction

This feature allows you to hear the voice of the person you are talking to more clearly, by reducing the surrounding noise coming from the other party's telephone.

- 1 Press **[MENU]** while talking.
- 2 **[]**: "Noise reduction on" or "Noise reduction off" → **[SELECT]**

Note:

- The setting you made is kept for each line (landline and cellular lines).
The default settings are as follows:
 - for landline: "Noise reduction off"
 - for cellular lines: "Noise reduction on"
- Depending on the environment where this handset is being used, this feature may not be effective.
- This feature is not available while using the speakerphone.

Handset equalizer

This feature clarifies the voice of the person you are talking to, producing a more natural-sounding voice that is easier to hear and understand.

- 1 Press **[MENU]** while talking.
- 2 **[]**: "Equalizer" → **[SELECT]**
- 3 **[]**: Select the desired setting.
- 4 Press **[OK]** to exit.

Note:

- The setting you made is kept for each line (landline and cellular lines).
- Depending on the condition and quality of your telephone line, this feature may emphasize existing line noise. If it becomes difficult to hear, select another setting.
- This feature is not available while using the speakerphone.
- When both the “**Equalizer**” setting and noise reduction are activated, **NR** is shown on the display.

Recording a telephone conversation (2-way recording)

This unit can record a telephone conversations during landline calls.

- 1 Press **[MENU]** during a landline call.
- 2 **[↕]**: “2 way recording” → **[SELECT]**
 - The total recordable time is displayed.
 - The unit announces to both parties that the recording will start.
 - The unit starts recording.
- 3 To stop recording, press **[MENU]** → **[↕]**: “stop recording” → **[SELECT]**
 - You can continue the conversation with the outside caller.

Note:

- When recording is completed:
 - The total number of recordings will be added to the number of messages in the answering system.
 - **[▶]** on the base unit flashes.
 - “**New message**” is displayed.
 - Audible message alert sounds on base unit (page 64).
- To listen to the recorded conversation, refer “Listening to messages”, page 63.
- 2 way recording is not available during conference calls.
- The recording will end in the following situations:
 - When **[FLASH]** is pressed.
 - When the hold or intercom feature is used.
- When memory is/becomes full:
 - “**Memory full**” is shown on the display.

- An error tone sounds.

Call share

You can join an existing outside call.

■ While another unit is on a cellular call:

- 1 To join the conversation, press **[CELL]**.
 - You can join the conversation in the following situations.
 - Only 1 cellular phone is paired.
 - A specific line is set to make cellular calls (page 21).

- 2 **[↕]**: Select the corresponding cellular phone. → **[SELECT]**

■ While another unit is on a landline call:

To join the conversation, press **[↕]**.

Note:

- When another user joins the conversation, the interrupt tone sounds.
- A maximum of 3 parties (including 1 outside party) can join a conversation using 2 extensions. (**3-way conference**)
- To prevent other users from joining your conversations with outside callers, turn call sharing mode off (page 46).
- A 2nd party cannot join an outside call that is being recorded (page 25).

Transferring calls, conference calls

Outside calls can be transferred or a conference call with an outside party can be made between handsets.

- 1 During an outside call, press **[MENU]**.
- 2 **[↕]**: “Intercom” → **[SELECT]**
- 3 **[↕]**: Select the desired unit. → **[SELECT]**
 - If you select “**Voice paging**”, the call will be switched from the ear-receiver mode to the speakerphone mode.
- 4 Wait for the paged party to answer.
 - If the paged party does not answer, press **[BACK]** to return to the outside call.

Making/Answering Calls

5 To complete the transfer:

Press **[OFF]**.

To establish a conference call:

[MENU] → **[⇩]**: "Conference" → **[SELECT]**

- To leave the conference, press **[OFF]**.
The other 2 parties can continue the conversation.

- To put the outside call on hold:

[MENU] → **[⇩]**: "Hold" → **[SELECT]**

To resume the conference: **[MENU]**

→ **[⇩]**: "Conference" → **[SELECT]**

- To cancel the conference: **[MENU]** → **[⇩]**: "Stop conference" → **[SELECT]**

You can continue the conversation with the outside caller.

Transferring a cellular call between the handset and a cellular phone

Transferring a cellular call from the handset to a cellular phone

1 Press **[MENU]** during a cellular call.

2 **[⇩]**: "Transfer to cell" → **[SELECT]**

- The cellular call is transferred to the cellular phone.

Note:

- Depending on your cellular phone type, you may need to set the cellular phone to be ready to talk before transferring. For example, if your cellular phone has a top cover, open it beforehand.

Transferring a cellular call from a cellular phone to the handset

During a conversation using a cellular phone, the call cannot be transferred to the handset by the cellular phone. Perform the following with the handset.

- 1 During a conversation using a cellular phone, press **[CELL]**.
 - The call is transferred to the handset in the following situations.

- Only 1 cellular phone is paired.
- A specific line is set to make cellular calls (page 21).

2 **[⇩]**: Select the corresponding cellular phone. → **[SELECT]**

- The call is transferred to the handset.

Answering a 2nd call

If you receive a call while talking on the phone, the interrupt tone sounds (page 44) and the 2nd caller's information is displayed if you subscribe to Caller ID service (page 53).

Answering a cellular call during a landline call

1 Press **[MENU]** during a landline call.

2 **[⇩]**: "Hold" → **[SELECT]**

3 **To answer the 2nd call:**

Press **[CELL]** while the 2nd call is being received.

4 To hang up the 2nd call and return to the 1st call (landline call), press **[OFF]**, then press **[↶]**.

Answering a landline call during a cellular call

1 Press **[MENU]** during a cellular call.

2 **[⇩]**: "Hold" → **[SELECT]**

3 **To answer the 2nd call:**

Press **[↶]** while the 2nd call is being received.

4 To hang up the 2nd call and return to the 1st call (cellular call), press **[OFF]**, then press **[CELL]**.^{*1}

*1 If you press **[CELL]** and the selection list is displayed, select the desired cellular line and press **[SELECT]**.

Intercom

Intercom calls can be made between handsets.

Making/Answering Calls

Note:

- When paging unit(s), the paged unit(s) beeps for 1 minute.
- If you receive an outside call while talking on the intercom, the interrupt tone sounds (page 44).
To finish intercom, press **[OFF]**. To answer the call, press **[📞]**.
- To change the handset ringer volume and ringer tone for intercom, see page 44.

Making an intercom call

- 1 **[MENU]** → **[↕]**: “Intercom” → **[SELECT]**
- 2 **[↕]**: Select the desired unit or “voice paging” → **[SELECT]**
 - If you select “voice paging”, speak into the microphone after the beep. Your voice will be heard using the speakers of all handsets, until a paged party answers your page or until you press **[OFF]**.
After the other party answers, the speakerphone mode is turned on.
- 3 When you finish talking, press **[OFF]**.

Note:

- You can also use the **[INTERCOM]** soft key, if displayed, to make intercom calls.
- You cannot use voice paging if other units are in use.

Answering an intercom call

- 1 Press **[📞]** to answer the page.
- 2 When you finish talking, press **[OFF]**.

Turning auto intercom on/off

This feature allows the handset to answer intercom calls automatically when it is called. You do not need to press **[📞]** or **[📞]**. When this feature is set to “On”, the monitoring handset for the baby monitor feature (page 51) will also answer baby monitor calls automatically. The default setting is “Off”.

- 1 **[MENU]** **[#]** **[2]** **[7]** **[3]**
- 2 **[↕]**: Select the desired setting. → **[SAVE]**
- 3 **[OFF]**

Note:

- This feature is not available for all handsets paging and voice paging even if it is turned on.

Answer by Voice Command

Answer by voice command

This feature allows you to answer incoming calls automatically with your voice. When your voice is detected, answered calls will automatically be directed to the speakerphone mode. The default setting is “OFF”.

Important:

- Before using this feature, we recommend that you test it and adjust the voice command sensitivity as needed.
- For best performance, answer the call within a range of 50 cm (20 inches) to 1 m (40 inches).
- Once this feature is turned on, the Talking Caller ID will be activated automatically. To turn off the Talking Caller ID feature, see page 44.
- Ambient noise (dog barking, TV sound, etc.) may cause the unit to answer an incoming call.
- When this feature is used, the unit disconnects the call automatically after 3 minutes. You may hear a warning tone and the unit may prompt you to press **[X]** to continue talking 1 minute before disconnecting.
- Once you press any key operations during a call, the call is continued.

Note:

- When a call is manually answered using a unit, voice detection will end, and the answer by voice command feature stops operating.
- This feature is not available while baby monitor is set to “on” (page 47).
- The configured settings are common for all lines (landline and cellular lines).

Turning answer by voice command on/off

- 1 Press and hold **[X]** for about 2 seconds.
- 2 **[↕]**: Select the desired setting. → **[SAVE]**
 - If you selected “OFF”, go to step 4 to exit.

- 3 **[YES]** → The unit will display and announce the voice command guidance.
 - We recommend answering calls as demonstrated.
 - There must be a 1 second pause between the two phrases.
- 4 **To stop:** Press **[STOP]**.
To playback: Press **[YES]**.
To exit: Press **[OFF]**.

Note:

- When answer by voice command is set to “on”, only use “Tone 1” to “Tone 5” as your ringer tone (page 42, 44). If another ringer tone is selected, the unit will automatically use the default ringer tones (Landline: “Tone 1”, CELL 1: “Tone 2”, CELL 2: “Tone 4”).

Answer by voice command sensitivity

You can adjust the sensitivity of the answer by voice command. Increase or decrease the sensitivity to adjust the sound level needed to trigger the answer by voice command feature.

- 1 **[MENU][#][1][0][7]**
- 2 **[↕]**: Select the desired setting. → **[SAVE]** → **[OFF]**

Answering calls

- 1 When the unit rings, speak clearly as demonstrated by the voice guidance. Refer to step 3, “Turning answer by voice command on/off”, page 28.
- 2 When you finish talking, press **[OFF]**.

Call block

You can press the **[CALL BLOCK]** button in the following situations to disconnect the current call and add a phone number to the call block list:

- when an incoming call is being received
- when an incoming call is being recorded by the answering system
- when talking on an outside call

Once a phone number has been added to the call block list, the unit will block calls from that phone number in the future.

- 1 Press **[CALL BLOCK]** under the situations shown above.
- 2 Confirm the call block number and press **[YES]**.
 - The call block number is stored in the call block list, confirmation tone sounds*1 and “Call blocked” is displayed, and then the call is disconnected.

*1 Confirmation tones are used with permission of © 2018 Copyrights Vision Inc.

Note:

- If the call has no phone number, the call is blocked but it is not stored in the call block list.
- The call block feature is not available:
 - for intercom calls or calls received by call waiting.
 - when a landline call (or cellular call) is being received during a cellular call (or landline call).
- Blocked calls are logged in the caller list.

Storing unwanted callers

The unit can block calls by storing the desired items in the call block list beforehand (Caller ID subscribers only).

- “Block a single number”: The unit blocks calls from specific phone numbers stored in the call block list.
- “Block range of numbers”: The unit blocks calls that begin with a number stored

in the call block list, such as a toll-free phone number prefix or certain area codes.

- “Block unknown CID”: The unit blocks calls that have no phone number.

Single phone numbers and ranges of numbers can be stored in the call block list up to 1,000 items in total.

Blocking unwanted callers:

When a call is received, the unit will not ring while caller information is being received.*1 If the caller’s phone number matches an entry in the call block list, the unit emits no sound to the caller, and disconnects the call.

*1 If you want the first ring to sound, select “Yes” in “Turning the first ring on/off” (page 30).

Storing a single phone number

Important:

- We recommend storing 10 digits (including the area code). If only 7 digits are stored, all numbers that have the same last 7 digits will be blocked.

Adding call blocked numbers from the caller list

■ When a cellular phone is paired:

- 1 **[v]** CID
- 2 **[↕]**: Select the desired entry to be blocked.
 - To edit the number:
 - [SELECT]** → Press **[X]** (Edit) repeatedly until the phone number is shown in the 10-digit format. → **[SAVE]** → **[↕]**: “Call block” → **[SELECT]** → Go to step 4.
- 3 **[CALL BLOCK]**
- 4 **[↕]**: “Yes” → **[SELECT]**
- 5 Edit the phone number if necessary (24 digits max.). → **[SAVE]** → **[OFF]**

■ When a cellular phone is not paired:

- 1 **[v]** CID
- 2 **[↕]**: Select the desired entry to be blocked.
 - To edit the number: **[MENU]** → **[↕]**: “Edit” → **[SELECT]**

Call Block

Press **[EDIT]** repeatedly until the phone number is shown in the 10-digit format. → **[SAVE]** → **[↕]**: "Call block" → **[SELECT]** → Go to step 4.

- [CALL BLOCK]**
- [↕]**: "Yes" → **[SELECT]**
- Edit the phone number if necessary (24 digits max.). → **[SAVE]** → **[OFF]**

Adding call blocked numbers manually

- [CALL BLOCK]**
- [↕]**: "Block a single number" → **[SELECT]**
- [MENU]** → **[↕]**: "Add" → **[SELECT]**
- Enter the phone number (24 digits max.). → **[SAVE]** → **[OFF]**

Storing a range of number

- [CALL BLOCK]**
- [↕]**: "Block range of numbers" → **[SELECT]**
- [MENU]** → **[↕]**: "Add" → **[SELECT]**
- Enter the desired number (2-8 digits). → **[SAVE]** → **[OFF]**

Blocking incoming calls that have no phone number

You can block calls when no phone number is provided, such as private callers or out of area calls.

- [CALL BLOCK]**
- [↕]**: "Block unknown CID" → **[SELECT]**
- [↕]**: Select the desired setting. → **[SAVE]** → **[OFF]**

Turning the first ring on/off

You can choose whether the first ring sounds when a call is received.

"Yes": The first ring for all calls will be heard, including calls from blocked phone numbers.
"No" (default): The first ring is muted for all calls. If this setting is selected, the unit will never ring for calls from blocked phone numbers.

- [CALL BLOCK]**
- [↕]**: "One ring for blocked call" → **[SELECT]**
- [↕]**: Select the desired setting. → **[SAVE]** → **[OFF]**

Viewing/editing/unblocking call block numbers

- [CALL BLOCK]**
- [↕]**: "Block a single number" or "Block range of numbers" → **[SELECT]**
- [↕]**: Select the desired entry.
 - After viewing, press **[OFF]** to exit.
- To edit a number:**
[EDIT] → Edit the number. → **[SAVE]** → **[OFF]**
To unblock a number:
[UNBLOCK] → **[↕]**: "Yes" → **[SELECT]** → **[OFF]**

Note:

- When editing, press the desired dial key to add digits and press **[CLEAR]** to erase digits.

Unblocking all call block numbers

- [CALL BLOCK]**
- [↕]**: "Block a single number" or "Block range of numbers" → **[SELECT]**
- [MENU]** → **[↕]**: "Unblock all" → **[SELECT]**
- [↕]**: "Yes" → **[SELECT]**
- [↕]**: "Yes" → **[SELECT]** → **[OFF]**

Displaying and clearing the blocked call count

- 1 [CALL BLOCK]
- 2 [↕]: "Blocked calls count" →
[SELECT]
 - To exit, press [OFF].
- 3 [CLEAR]
- 4 [↕]: "yes" → [SELECT] → [OFF]

Automated call block

With automated call block, the unit screens incoming calls before ringing for allowed calls, or ends the calls without ringing for calls identified as robocalls, telemarketing calls, or other undesirable calls (Caller ID subscribers only).

The unit will play the greeting message for automated call block and prompt the caller to enter an access code in order for the unit to identify whether the call is automated. You can set the unit to block or unblock mode. The default setting is “**Unb1ock**”.

Note:

- The unit connects the call without prompting to enter the access code in the following situations:
 - the caller’s phone number matches an entry in the phonebook (page 36).
 - the caller’s name matches an entry in the allow name list (page 33).
 - the caller’s phone number is memorized in the allowed number database (page 32).
- If you have your cell phone connected via Link to Cell, even if automated call block is set to “**B1ock**”, incoming cellular calls will still be connected automatically without requiring the access code.
- If the number is stored in the call block list (page 29), the unit disconnects the call without playing the greeting message for automated call block.
- The automated call block feature is not available:
 - when a landline call is being received during a cellular call.
- When the answering system answers a call from a caller who is not registered in the phonebook, allow name list, or allowed number database, the following operations are delayed:
 - answering a call
 - remote turn on
 - toll saver
- When the unit receives a call from a caller who is not registered in the phonebook, allow name list, or allowed number

database in the following situations, the unit shifts to standby mode:

- when searching the phonebook, caller list, call block list, or allow name list
- when programming (depending on settings)
- when using the answering system
- when paging all handsets
- Blocked calls are logged in the caller list. We recommend you to check the caller list periodically. If necessary, register the entry to the phonebook or allow name list to connect the call next time.

Allowed number database

Once the caller enters the access code, the caller’s phone number is memorized in the allowed number database as an unblocked number. Callers from this database are allowed to connect without the access code from their next call.

100 entries can be stored to the database (22 digits max. each).

Note:

- When the database memory is full, the latest call received will replace the oldest number stored in the list.
- The numbers stored in the database will be erased when you change the access code (page 32).
- The numbers stored in the database cannot be displayed.

Setting the automated call block

- 1 **[MENU]** **[#]** **[7]** **[8]** **[7]**
- 2 **[↕]**: Select the desired setting. → **[SAVE]**
- 3 **[↕]**: “Yes” → **[SELECT]** → **[OFF]**

Note:

- We recommend you perform a test run of the automated call block procedure to ensure that the automated call block feature is set correctly.

Changing the access code

If the unit answers undesirable calls such as robocalls even though the automated call

Enhanced Call Block

block function is on, change the access code (3 digits max.). The default setting is "1".

- 1 **[MENU]** **[#]** **[7]** **[8]** **[9]**
- 2 **[CLEAR]**
- 3 Enter the new access code. → **[SAVE]**
→ **[OFF]**

Displaying and clearing the blocked call count

The total number of blocked calls (up to 65,000) will be displayed.

- 1 **[MENU]** **[#]** **[7]** **[9]** **[0]**
 - To exit, press **[OFF]**.
- 2 **[CLEAR]**
- 3 **[↕]**: "Yes" → **[SELECT]** → **[OFF]**

Adding to the allow name list

You can allow specific callers to pass through by adding the caller's name to the allow name list.

You can store up to 100 names (16 characters max.). If the name stored in the allow name list matches the incoming Caller ID, the unit rings. Callers listed in the allow name list are not required to enter the access code.

Adding allowed names from the caller list

- **When a cellular phone is paired:**
 - 1 **[▼]** CID
 - 2 **[↕]**: Select the desired entry. → **[SELECT]**
 - 3 **[SAVE]**
 - 4 **[↕]**: "Allow name" → **[SELECT]**
→ **[OFF]**
- **When a cellular phone is not paired:**
 - 1 **[▼]** CID
 - 2 **[↕]**: Select the desired entry. → **[MENU]**
 - 3 **[↕]**: "Save allow name" → **[SELECT]** → **[OFF]**

Viewing/erasing an entry

- 1 **[MENU]** **[#]** **[7]** **[9]** **[4]**
- 2 **[↕]**: Select the desired entry.
 - After viewing, press **[OFF]** to exit.
- 3 **[ERASE]** → **[↕]**: "Yes" → **[SELECT]**
→ **[OFF]**

Erasing all entries

- 1 **[MENU]** **[#]** **[7]** **[9]** **[4]**
- 2 **[ERASE]** → **[↕]**: "Yes" → **[SELECT]**
- 3 **[↕]**: "Yes" → **[SELECT]** → **[OFF]**

Greeting message for automated call block

When the unit answers a call, a greeting message is played to the caller.

You can use either:

- your own greeting message and pre-recorded greeting message
- pre-recorded greeting message

Recording a greeting message for automated call block

Using this feature, the unit can play your own greeting message and pre-recorded greeting message.

Example of your own greeting message:

"Hi, you have reached xxxxxx (Name)."
"Thank you for your calling. You have reached xxxxxx (Name)."
"Hi, you have reached the xxxxxx (Name) residence."

- 1 **[MENU]** **[#]** **[7]** **[9]** **[1]**
- 2 **[↕]**: "Yes" → **[SELECT]**
- 3 After a beep sounds, hold the handset about 20 cm (8 inches) away and speak clearly into the microphone (2 minutes max.).
- 4 Press **[STOP]** to stop recording.
- 5 The unit will play the recorded greeting message for automated call block. → **[OFF]**

Enhanced Call Block

Resetting to the pre-recorded greeting message for automated call block

This procedure will erase your greeting message for automated call block and reset to the pre-recorded one.

- 1 [MENU] [#] [7] [9] [3]
- 2 [YES] → [OFF]

Playing back the greeting message for automated call block

- 1 [MENU] [#] [7] [9] [2]
- 2 To exit, press [OFF].

Telemarketing call block

In addition to Automated call block (page 32), you can use Telemarketing call block to further screen calls to stop telemarketer calls from getting through.

Using this feature, you can ask callers to say their names, and after checking the names, you can decide whether to answer the calls or not.

Note:

- This feature is only available for landline calls.
- While screening calls, the call waiting feature is unavailable (page 24).
- Telemarketing call block guidance and caller name announcement cannot be heard using a Bluetooth headset.

Operating telemarketing call block

- 1 During a landline call, lift the handset and then press [TELE.BLK.].
 - The unit prompts callers to say their names.
- 2 **To answer the call:**
Press [↶] or [↷].
To block the call:
Press [CALL BLOCK]*1 → [YES].

- The unit announces that the call will be disconnected, and disconnects the call.
 - The caller will be registered to call block list.
- *1 The user can still answer the call after pressing [CALL BLOCK]. To answer the call, press [↶] or [↷].

Note:

- If there is no response from the caller, and the user does not press any keys in step 2 within 10 seconds, the unit will announce that the call will be disconnected, and disconnects the call.
- While on the charger, the [TELE.BLK.] key is not available. Lift the handset from the charger to use this feature.
- To use this feature, set the Auto talk feature to "off".

One ring scam alert

The one ring scam alert feature notifies the user when calling back a number that is judged to be a scam call. This can help reduce the risk of calling back expensive international numbers.

During an incoming call, if the caller disconnects the call after 1 or 2 rings, the call is judged to be a scam call. Depending on the number of rings made before a call is disconnected, a non-malicious call may also be judged as a scam call. The default setting is "1 or 2 rings".

Note:

- The call will not be judged as a scam call in the following conditions:
 - When a call is answered by pressing [↶] or [↷] (page 23).
 - When a call is screened by pressing [TELE.BLK.] (page 34).
 - When a call is answered with Answer by voice Command (page 28).
 - When a call is blocked with the call block feature (page 29).
 - When automated call block is set to "Block" (page 32).
 - When a call is answered by the answering system.

To use this feature, set the ring count for the answering system to more than the number of rings of the one ring scam alert (page 62).

- When a call is answered by a voicemail service.
To use this feature, set the ring count for the voicemail service to more than the number of rings of the one ring scam alert (call your service provider) (page 68).
- When the caller's phone number matches an entry in the phonebook (page 33).
- When you do not subscribe to the caller ID service.
- When the call is disconnected before receiving caller ID information.
- During call waiting, the unit cannot judge whether the 2nd caller is a scam call.

Setting the number of rings for one ring scam

1 [MENU]#798

2 [↓]: Select the desired setting. →
[SAVE]

"1 ring" Judge 1 ring as a scam call.
"1 or 2 rings" Judge 1 or 2 rings as a scam call.
"Off" Turns off the setting and does not judge as scam calls.

Note:

- When a phone number is judged as a scam call, "△" will be displayed in the caller list unless:
 - the number is identified as Automated call block.
 - the number is stored in the call block list.

Phonebook

Phonebook

You can add 3,000 names (16 characters max.) and phone numbers (24 digits max.) to the phonebook, and assign each phonebook entry to the desired group (page 37). The following groups are available:

- Group 1: “Home”¹ (default)
- Group 2: “Cell 1”¹
- Group 3: “Cell 2”¹
- Group 4-9: You can change the group name for each group.

*1 For groups 1-3, the group names cannot be changed.

Important:

- All entries can be shared by any registered handset.
- You can copy phonebook entries from a Bluetooth cellular phone to the unit’s phonebook (page 56).

Adding phonebook entries

- 1 [◀] □ □ → [MENU]
- 2 [↕]: “Add new entry” → [SELECT]
- 3 Enter the party’s name. → [OK]
- 4 Enter the party’s phone number. → [OK]
- 5 [↕]: Select the desired group. → [SELECT] 2 times → [OFF]

Note:

- In step 3, you can switch the language for entering characters.
[#] → [↕]: Select the desired language. → [OK]

Entering characters

Press the dial key that corresponds to the desired character. Press repeatedly to scroll through the available characters. The following operations are also available.

Key	Operation
[X]	Switch between the uppercase and lowercase (A ↔ a)

Key	Operation
[◀] [▶]	Move the cursor
[CLEAR]	Erase the character or number <ul style="list-style-type: none">• To erase all, press and hold it.

- To enter another character that is located on the same dial key, first press [▶] to move the cursor to the next space.
- If you do not press any dial key within 2 seconds after entering a character, the character is fixed and the cursor moves to the next space.

Storing a redial list number to the phonebook

Phone numbers of up to 24 digits can be stored in the phonebook.

■ When a cellular phone is paired:

- 1 [▶] REDIAL
- 2 [↕]: Select the desired entry. → [MENU]
- 3 [↕]: “Save” → [SELECT]
- 4 To store the name, continue from step 3, “Editing entries”, page 38.

■ When a cellular phone is not paired:

- 1 [▶] REDIAL
- 2 [↕]: Select the desired entry. → [SAVE]
- 3 To store the name, continue from step 3, “Editing entries”, page 38.

Note:

- The name stored in the phonebook will be reflected in the redial list after you make a call using that phonebook entry.

Storing caller information to the phonebook

■ When a cellular phone is paired:

- 1 [▼] CID
- 2 [↕]: Select the desired entry. → [SELECT]
 - To edit the number, press [X] (Edit) repeatedly until the phone number is shown in the desired format.

- 3 [SAVE]
- 4 [↕]: "Phonebook" → [SELECT]
- 5 Continue from step 3, "Editing entries", page 38.

■ When a cellular phone is not paired:

- 1 [v] CID
- 2 [↕]: Select the desired entry. → [MENU]
 - To edit the number:
[↕]: "Edit" → [SELECT]
Press [EDIT] repeatedly until the phone number is shown in the desired format. → [SAVE] → [↕]: "Phonebook" → [SELECT] → Go to step 4.
- 3 [↕]: "Save phonebook" → [SELECT]
- 4 Continue from step 3, "Editing entries", page 38.

Groups

Groups can help you find entries in the phonebook quickly and easily. You can change the group name for groups 4-9 ("Friends", "Family", etc.). By assigning different ringer tones for different groups of callers, you can identify who is calling (ringer ID), if you have subscribed to Caller ID service.

Changing group names/setting ringer ID

- 1 [←] □ → [MENU]
- 2 [↕]: "Group" → [SELECT]
- 3 [↕]: Select the desired group. → [SELECT]
 - If you selected "Home", "Cell 1", or "Cell 2", go to step 5.
- 4 To change group names
[↕]: "Group name" → [SELECT] → Edit the name (10 characters max.). → [SAVE]

- 5 To set group ringer tone
[↕]: Select the current setting of the group ringer tone. → [SELECT] → [↕]: Select the desired ringer tone. → [SAVE]
- 6 [OFF]

Finding and calling from a phonebook entry

- 1 [←] □
- 2 To scroll through all entries
[↕]: Select the desired entry.
To search by first character
 - ① Press the dial key ([0] to [9], or [#]) which contains the character you are searching for.
 - ② [↕]: Scroll through the phonebook if necessary.

To search by group

- ① [GROUP]
- ② [↕]: Select the desired group. → [SELECT]
- ③ [↕]: Scroll through the phonebook if necessary.

To search by query

You can narrow down the search to enter the first characters of a name.

- ① [x]
- ② To search for the name, enter the first characters (up to 4) in uppercase. → [OK]
- ③ [↕]: Scroll through the phonebook if necessary.

3 ■ Using a cellular line:

- ① [CELL]
 - The unit starts dialing immediately in the following situations.
 - Only 1 cellular phone is paired.
 - A specific line is set to make cellular calls (page 21).
- ② [↕]: Select the desired cellular phone. → [SELECT]

■ Using a landline:

[↩]

Phonebook

Editing entries

- 1 Find the desired entry (page 37).
- 2 **[MENU]** → **[↕]**: “Edit” → **[SELECT]**
- 3 Edit the name if necessary. → **[OK]**
- 4 Edit the phone number if necessary. → **[OK]**
- 5 **[↕]**: Select the desired group (page 37). → **[SELECT]** 2 times → **[OFF]**

Erasing entries

Erasing an entry

- 1 Find the desired entry (page 37).
- 2 **[MENU]** → **[↕]**: “Erase” → **[SELECT]**
- 3 **[↕]**: “Yes” → **[SELECT]** → **[OFF]**

Erasing all entries

- 1 **[←] □□** → **[MENU]**
- 2 **[↕]**: “Erase all” → **[SELECT]**
- 3 **[↕]**: Select the desired group. → **[SELECT]**
- 4 **[↕]**: “Yes” → **[SELECT]**
- 5 **[↕]**: “Yes” → **[SELECT]** → **[OFF]**

Chain dial

This feature allows you to dial phone numbers in the phonebook while you are on a call. This feature can be used, for example, to dial a calling card access number or bank account PIN that you have stored in the phonebook, without having to dial manually.

- 1 During an outside call, press **[←] □□**.
- 2 **[↕]**: Select the desired entry.
- 3 Press **[CALL]** to dial the number.

Note:

- When storing a calling card access number and your PIN in the phonebook as one phonebook entry, press **[▲]** (Pause) to add pauses after the number and PIN as necessary (page 23).

- If you have rotary/pulse service, you need to press **[☒]** before pressing **[←] □□** in step 1 to change the dialing mode temporarily to tone. When adding entries to the phonebook, we recommend adding **[☒]** to the beginning of phone numbers you wish to chain dial (page 36).

Speed dial

You can assign 1 phone number to each of the dial keys (**[1]** to **[9]**) on the handset.

Adding phone numbers to speed dial keys

■ By entering phone numbers:

- 1 Press and hold the desired speed dial key (**[1]** to **[9]**). → **[ADD]**
- 2 **[↕]**: “Manual” → **[SELECT]**
- 3 Enter the party's name (16 characters max.). → **[OK]**
- 4 Enter the party's phone number (24 digits max.). → **[OK]** → **[SELECT]** → **[OFF]**

■ From the phonebook:

- 1 Press and hold the desired speed dial key (**[1]** to **[9]**). → **[ADD]**
- 2 **[↕]**: “Phonebook” → **[SELECT]**
- 3 **[↕]**: Select the desired entry. → **[SAVE]** → **[OFF]**

Note:

- If you edit a phonebook entry which is assigned to a speed dial key, the edited entry does not transfer to the speed dial key.

Editing an entry

- 1 Press and hold the desired speed dial key (**[1]** to **[9]**). → **[MENU]**
- 2 **[↕]**: “Edit” → **[SELECT]**
- 3 Edit the name if necessary. → **[OK]**
- 4 Edit the phone number if necessary. → **[OK]** → **[SELECT]** → **[OFF]**

Erasing an entry

- 1 Press and hold the desired speed dial key ([1] to [9]). → [MENU]
- 2 [↕]: "Erase" → [SELECT]
- 3 [↕]: "Yes" → [SELECT] → [OFF]

Viewing an entry/Making a call

■ Using a cellular line:

- 1 Press and hold the desired speed dial key ([1] to [9]).
- 2 [CELL]
 - The unit starts dialing immediately in the following situations.
 - Only 1 cellular phone is paired.
 - A specific line is set to make cellular calls (page 21).
- 3 [↕]: Select the desired cellular phone. → [SELECT]

■ Using a landline:

- 1 Press and hold the desired speed dial key ([1] to [9]).
- 2 To make a call, press [📞].

Programming

Menu list

To access the features, there are 2 methods.

■ Scrolling through the display menus

- 1 [MENU]
- 2 Press [▼] or [▲] to select the desired main menu. → [SELECT]
- 3 Press [▼] or [▲] to select the desired item from the next sub-menus. → [SELECT]
- 4 Press [▼] or [▲] to select the desired setting. → [SAVE]

■ Using the direct command code

- 1 [MENU] → Enter the desired code.
Example: Press [MENU]#101.
- 2 Select the desired setting. → [SAVE]

Note:

- To exit the operation, press [OFF].
- In the following table, < > indicates the default settings.
- In the following table,  indicates the reference page number.
- Display menu order and sub-menu may vary depending on your model.

Display menu tree and direct command code table

Main menu:  "Phonebook"

Operation	Code	
Viewing the phonebook entry.	#280	37

Main menu: →) "Caller list"

Operation	Code	
Viewing the caller list.	#213	53

Main menu:  "Answering device"

Sub-menu 1	Sub-menu 2	Settings	Code	
Play new message	–	–	#323	63
Play all message	–	–	#324	63
Erase all message*1	–	–	#325	64
Greeting	Record greeting*1	–	#302	62
	Check greeting	–	#303	63
	Pre-recorded*1 (Reset to pre-recorded greeting)	–	#304	63

Programming

Sub-menu 1	Sub-menu 2	Settings	Code	
New message alert ^{*1}	Outgoing call – On/Off	On <Off>	#338	64
	Outgoing call – Notification to	–		
	Outgoing call – Remote code	Activate <Inactivate>		
	Base unit beep	On <Off>	#339	64
Settings	Ring count ^{*1}	Toll saver 2-7 rings <4 rings>	#211	67
	Recording time ^{*1}	<3 min> 1 min Greeting only ^{*2}	#305	67
	Remote code ^{*1}	<111>	#306	66
	Screen call	<On> Off	#310	67
Answer on ^{*1}	–	–	#327	62
Answer off ^{*1}	–	–	#328	62

Main menu:  "Voicemail access"^{*3}

Operation	Code	
Listening to voicemail messages.	#330	68

Main menu:  "Intercom"

Operation	Code	
Paging the desired unit.	#274	27

Programming

Main menu:  "Bluetooth"

Sub-menu 1	Sub-menu 2	Settings	Code	
Link to cell – 1: Add new device ^{*4} (for CELL 1) – 2: Add new device ^{*4} (for CELL 2)	Connect ^{*1} / Disconnect ^{*1}	–	#6251 ^{*5}	20
			#6252 ^{*6}	
	Ringer volume – Handset	Off-6 <6>	#6281 ^{*5}	23
			#6282 ^{*6}	
	Ringer volume – Base unit ^{*1}	Off-6 <1>	#*6281 ^{*5}	–
			#*6282 ^{*6}	
	Ringer tone ^{*7}	<Tone 2> ^{*5} <Tone 4> ^{*6}	#6291 ^{*5}	–
			#6292 ^{*6}	
	Select unit to ring ^{*1}	<All> Handset 1-6	#6271 ^{*5}	19
			#6272 ^{*6}	
	Ring as cell (limited) ^{*1}	<On (with Talking CID)> On (without Talking CID) Off	#6141 ^{*5}	19
			#6142 ^{*6}	
	Alert settings ^{*1} – Alert On/Off	<On> Off	#6101 ^{*5}	58
			#6102 ^{*6}	
Alert settings ^{*1} – Voice alert	<On> Off	#6031 ^{*5}	58	
		#6032 ^{*6}		
Alert settings ^{*8} – Alert tone	<Tone 1> ^{*5} <Tone 2> ^{*6}	#6041 ^{*5}	58	
		#6042 ^{*6}		
Pair	–	#6241 ^{*5}	18	
		#6242 ^{*6}		
Unpair	–	#6111 ^{*5}	18	
		#6112 ^{*6}		
Phonebook transfer	–	–	#618	56
Headset	Add new device ^{*4}	–	#621	59
	Connect ^{*1} / Disconnect ^{*1}	–	#622	60
	Pair	–	#621	59
	Unpair	–	#612	60

Programming

Sub-menu 1	Sub-menu 2	Settings	Code	
Settings	Auto connect* ¹	Off <1 min> 3 min 5 min 10 min	#632	19
	Cell area code* ¹	–	#633	21
	Cell line only mode* ¹	On <Off>	#157	20
	Cell line select	<Manual> Cellphone 1* ⁴ Cellphone 2* ⁴	#634	21
	Set PIN* ¹	<0000>	#619	21
	International code* ¹	–	#117	56
	Country code* ¹	–	#118	
	Trunk prefix* ¹	–	#119	

Main menu: "Set date & time"

Sub-menu 1	Sub-menu 2	Settings	Code	
Date and time* ¹	–	–	#101	16
Memo alarm	Alarm1-3	<Off> Once Daily Weekly	#720	48
Time adjustment* ^{1,9}	–	<Caller ID auto> Manual	#226	–

Main menu: "Speed dial"

Operation	Code	
Viewing the speed dial entry.	#261	38

Programming

Main menu:  "Settings"

Sub-menu 1	Sub-menu 2	Settings	Code	
Ring adjustments	Ringer volume (Incoming) – Handset ^{*3}	Off-6 <6>	#160	–
	Ringer volume (Incoming) – Base unit ^{*1, *3}	Off-6 <1>	#*160	–
	Intercom ringer volume	1-6 <6>	#175	–
	Ringer tone (Incoming) ^{*3, *7, *10} (Handset)	<Tone 1>	#161	–
	Intercom ringer tone ^{*7, *10}	<Tone 3>	#163	–
	Interrupt tone ^{*11}	<On> Off	#201	26
	Silent mode – On/Off	On <Off>	#238	49
	Silent mode – Start/End	<11:00 PM/06:00 AM>	#237	49
	Silent mode – Select group	Home Cell 1 Cell 2 Group 4-9	#241	49
Set date & time	Date and time ^{*1}	–	#101	16
	Memo alarm – Alarm1-3	<Off> Once Daily Weekly	#720	48
	Time adjustment ^{*1, *9}	<Caller ID auto> Manual	#226	–
Talking caller ID	Handset	<On> Off	#162	53
	Base unit ^{*1}	On <Off>	#*162	
Low battery alert	–	Off <Every hour> Every 3 hours Every 6 hours	#176	17

Programming

Sub-menu 1	Sub-menu 2	Settings	Code		
Key detector setting ^{*12} - 1: Add new device (for Detector1) ^{*13} - 2: Add new device (for Detector2) - 3: Add new device (for Detector3) - 4: Add new device (for Detector4)	Change name ^{*1}	Detector1	#6561	-	
		Detector2 ^{*14}	#6562 ^{*14}		
		Detector3 ^{*14}	#6563 ^{*14}		
		Detector4 ^{*14}	#6564 ^{*14}		
	Registration	-		#6571	-
				#6572 ^{*14}	
				#6573 ^{*14}	
				#6574 ^{*14}	
	Deregistration	-		#6581	-
				#6582 ^{*14}	
				#6583 ^{*14}	
				#6584 ^{*14}	
One ring scam ^{*1}	-	1 ring <1 or 2 rings> Off	#798	35	
Automated call block ^{*1}	Block/Unblock	Block <Unblock>	#787	32	
	Allow name list	-	#794	33	
	Access code	<1>	#789	32	
	Automated call greeting	Record greeting		#791	33
		Check greeting		#792	34
		Pre-recorded		#793	34
	Blocked calls count	-	#790	33	
Call block ^{*1}	Block a single number	-	#217	29	
	Block range of numbers	-		30	
	Block unknown CID (CID: Caller ID)	Block <Unblock>	#240	30	
	One ring for blocked call	Yes <No>	#173	30	
	Blocked calls count	-	#177	31	
Speed dial	-	-	#261	38	
Record greeting ^{*1}	-	-	#302	62	

For assistance, please visit <http://shop.panasonic.com/support>

45

Programming

Sub-menu 1	Sub-menu 2	Settings	Code	
Voicemail ^{*3}	Save VM access# ^{*1} (VM: Voicemail)	–	#331	68
	VM tone detect ^{*1}	<On> Off	#332	68
LCD contrast (Display contrast)	–	Level 1–4 <2>	#145	–
Handset name	–	–	#104	51
Display name	–	On <Off>	#105	51
Answer by voice command ^{*1}	On/Off	On <Off>	#106	28
	Sensitivity level	Low <Normal> High	#107	28
Auto intercom	–	On <Off>	#273	27
Key tone	–	<On> Off	#165	–
Caller ID edit (Caller ID number auto edit)	–	<On> Off	#214	54
Auto talk ^{*15}	–	On <Off>	#200	23
Set tel line ^{*3}	Set dial mode ^{*1}	<Tone> Pulse	#120	16
	Set flash time ^{*1,*16}	80 ms 90 ms 100 ms 110 ms 160 ms 200 ms 250 ms 300 ms 400 ms 600 ms <700 ms> 900 ms	#121	24
	Set line mode ^{*1,*17}	A 	#122	–
Call sharing ^{*1}	–	<On> Off	#194	25

Programming

Sub-menu 1	Sub-menu 2	Settings	Code	
Registration	Register handset	–	#130	51
	Deregistration*2	–	#131	52
Change language	Display	<English> Español	#110	16
	Announcement*1	<English> Español	#112	16

Main menu:  “Customer support”

Operation	Code	
Displaying customer support Web address.	#680	–

Main menu:  “Baby monitor”

Sub-menu 1	Sub-menu 2	Settings	Code	
On/Off	–	On <Off>	#268	50
Sensitivity level	–	Low <Middle> High	#269	51

Main menu:  “Key detector”*12

Sub-menu 1	Sub-menu 2	Settings	Code	
Search	–	–	#655	–
Battery check	–	–		

- *1 If you program these settings using one of the units, you do not need to program the same item using another unit.
- *2 This menu is not displayed when scrolling through the display menus. It is only available in direct command code.
- *3 When the cellular line only mode is turned on, these menus are not displayed (page 20).
- *4 After the Bluetooth device is paired, the device name is displayed.
- *5 For CELL 1
- *6 For CELL 2
- *7 The preset melodies in this product (“Melody 1” - “Melody 10”) are used with permission of © 2009 - 2012 Copyrights Vision Inc.
- *8 The preset melodies in this product (“Tone 1” and “Tone 2”) are used with permission of © 2013 Copyrights Vision Inc.
- *9 This feature allows the unit to automatically adjust the date and time each time caller information including date and time is received.
To turn this feature on, select “Caller ID auto”. To turn this feature off, select “Manual”. (Caller ID subscribers only)
To use this feature, set the date and time first (page 16).
- *10 If you subscribe to a distinctive ring service (such as IDENTA-RING), select a tone (tone 1 to 5). If you select a melody, you cannot distinguish lines by their ringers.

For assistance, please visit <http://shop.panasonic.com/support>

47

Programming

- *11 This tone lets you know when you receive an outside call while you are on another line or an intercom call. If you select “On”, the tone sounds 2 times.
- *12 This setting is available when you have the key detector (KX-TGA20). Read the installation manual for more information on the key detector.
- *13 For models with supplied key detectors, the display shows “1: Detector1”.
- *14 If you register 2 or more key detectors.
- *15 If you subscribe to a Caller ID service and want to view the caller’s information after lifting up the handset to answer a call, turn off this feature.
- *16 The flash time depends on your telephone exchange or host PBX. Contact your PBX supplier if necessary. The setting should stay at “700 ms” unless pressing **[FLASH]** fails to pick up the waiting call.
- *17 Generally, the line mode setting should not be changed. This setting automatically maintains receiver volume at the proper level depending on the current telephone line condition. Set the line mode to “A” if telephone line condition is not good.

Alarm

An alarm sounds at the set time for 1 minute and is repeated 5 times at 5 minute intervals (snooze function). A text memo can also be displayed for the alarm. A total of 3 separate alarm times can be programmed for each handset. You can set one of 3 different alarm options (once, daily, or weekly) for each alarm time.

Important:

- Make sure the unit’s date and time setting is correct (page 16).

- 1 **[MENU][#][7][2][0]**
- 2 **[↕]**: Select the desired alarm. → **[SELECT]**
- 3 **[↕]**: Select the desired alarm option. → **[SELECT]**

“Off” Turns alarm off. Go to step 10.
“Once” An alarm sounds once at the set time.
“Daily” An alarm sounds daily at the set time. Go to step 5.
“Weekly” Alarm sounds weekly at the set time(s).

- 4 Proceed with the operation according to your selection in step 3.

■ Once:

Enter the desired month and date. → **[OK]**

■ Weekly:

[↕]: Select the desired day of the week and press **[SELECT]**. → **[OK]**

- 5 Set the desired time.
- 6 **[☒]**: Select “AM” or “PM”. → **[OK]**
- 7 Enter a text memo (10 characters max.). → **[OK]**
- 8 **[↕]**: Select the desired alarm tone. → **[SELECT]**
 - We recommend selecting a different ringer tone from the one used for outside calls.
- 9 **[↕]**: Select the desired snooze setting. → **[SAVE]**
- 10 **[SELECT]** → **[OFF]**

Note:

- Press **[STOP]** to stop the alarm completely.
- When the handset is in use, the alarm will not sound until the handset is in standby mode.
- Press any dial key or **[SNOOZE]** to stop the sound but keep the snooze function activated.
- If you want to make an outside call when the snooze function is activated, please

stop the snooze function before making the call.

Silent mode

Silent mode allows you to select a period of time during which the handset will not ring for outside calls. This feature is useful for time periods when you do not want to be disturbed, for example, while sleeping. Silent mode can be set for each unit.

Using the phonebook's group feature (page 37), you can also select groups of callers whose calls override silent mode and ring the unit (Caller ID subscribers only).

Important:

- Make sure the unit's date and time setting is correct (page 16).
- We recommend turning the base unit ringer off (page 42, 44) in addition to turning the silent mode on.
- If you have set the alarm, the alarm sounds even if the silent mode is turned on.

Turning silent mode on/off

- 1 **[MENU][#][2][3][8]**
- 2 **[↓]**: Select the desired setting. → **[SAVE]**
 - If you select "OFF", press **[OFF]** to exit.
- 3 Enter the desired hour and minute you wish to start this feature.
- 4 **[X]**: Select "AM" or "PM". → **[OK]**
- 5 Enter the desired hour and minute you wish to end this feature.
- 6 **[X]**: Select "AM" or "PM".
- 7 **[SAVE]** → **[OFF]**

Changing the start and end time

- 1 **[MENU][#][2][3][7]**
- 2 Continue from step 3, "Turning silent mode on/off", page 49.

Selecting groups to bypass silent mode

- 1 **[MENU][#][2][4][1]**
- 2 **[↓]**: Select the desired groups. → **[SELECT]**
 - "✓" is displayed next to the selected group numbers.
 - To cancel the selected group: **[↓]**: Select the group. → Press **[SELECT]** again. "✓" disappears.
- 3 **[SAVE]** → **[OFF]**

Baby monitor

This feature allows you to listen in on a room where another handset is located, allowing you to easily monitor from different areas of the house or even while away from home. The monitored handset (placed in a baby's room, for example) will automatically call the monitoring handset or the phone number stored when it detects sound.

Important:

- Before using this feature, we recommend that you test it and adjust the baby monitor sensitivity as needed, especially if you plan to monitor from outside.
- This feature should not be used as a substitute for a medical or caregiver's supervision. It is the caregiver's responsibility to stay close enough to handle any eventuality.

Note:

- During the monitoring mode, battery consumption is faster than usual. We recommend leaving the monitored handset on charger.
- The monitored handset never rings while it is being monitored. If the base unit is placed near the monitored handset, we recommend turning off the base unit ringer volume (page 42, 44).

Programming

Setting the baby monitor

Perform the setting operation with the handset to be monitored (for example, the handset placed in a baby's room).

To monitor with a handset

The internal baby monitor feature is available between handsets.

- 1 **[MENU]** **[#]** **[2]** **[6]** **[8]**
- 2 **[↕]**: "On" → **[SELECT]**
- 3 **[↕]**: Select the desired handset's number to monitor with. → **[SAVE]**
 - "Baby monitor" will be displayed.
 - The registered handset's name/number is displayed.

Note:

- When this feature is on, another handset can hear the monitored handset by making an intercom call.

To monitor from outside

If you enable this feature, the unit will call a pre-programmed phone number when the handset detects sound. After you answer the call, you can listen in on the room where the handset is located.

This feature is only available for landline.

■ From the phonebook:

- 1 **[MENU]** **[#]** **[2]** **[6]** **[8]**
- 2 **[↕]**: "On" → **[SELECT]**
- 3 **[↕]**: Select "Outgoing call" to monitor from outside. → **[ADD]**
- 4 **[↕]**: "Phonebook" → **[SELECT]**
- 5 **[↕]**: Select the phonebook entry. → **[SAVE]**
 - "Baby monitor" will be displayed.

Note:

- If you edit a phonebook entry which is assigned for monitoring, the edited entry does not transfer to the monitor.

■ By entering phone numbers:

- 1 **[MENU]** **[#]** **[2]** **[6]** **[8]**
- 2 **[↕]**: "On" → **[SELECT]**

- 3 **[↕]**: Select "Outgoing call" to monitor from outside. → **[ADD]**
- 4 **[↕]**: "Manual" → **[SELECT]**
- 5 Enter the desired name. → **[OK]**
- 6 Enter the desired number. → **[OK]**
 - "Baby monitor" will be displayed.

Note:

- The registered name/number is displayed.

Turning off the baby monitor

The monitored handset cannot be used while baby monitor is set to "On".

- 1 Press **[MENU]** on the handset being monitored.
- 2 **[↕]**: "On/Off" → **[SELECT]**
- 3 **[↕]**: "Off" → **[SELECT]** → **[OFF]**

Editing an outside monitoring number

- 1 Press **[MENU]** on the handset being monitored.
- 2 **[↕]**: "On/Off" → **[SELECT]**
- 3 **[↕]**: "On" → **[SELECT]**
- 4 **[↕]**: Select the outside line. → **[MENU]**
- 5 **[↕]**: "Edit" → **[SELECT]**
- 6 Edit the name if necessary. → **[OK]**
- 7 Edit the phone number if necessary. → **[OK]** → **[SELECT]**

Erasing an outside monitoring number

- 1 Press **[MENU]** on the handset being monitored.
- 2 **[↕]**: "On/Off" → **[SELECT]**
- 3 **[↕]**: "On" → **[SELECT]**
- 4 **[↕]**: Select the outside line. → **[MENU]**
- 5 **[↕]**: "Erase" → **[SELECT]**
- 6 **[↕]**: "Yes" → **[SELECT]** → **[OFF]**

Baby monitor sensitivity

You can adjust the sensitivity of the baby monitor. Increase or decrease the sensitivity to adjust the sound level needed to trigger the baby monitor feature.

- This feature cannot be set during a monitoring call.
- 1 Press **[MENU]** on the handset being monitored.
 - 2 **[↕]**: “Sensitivity level” → **[SELECT]**
 - 3 **[↕]**: Select the desired setting. → **[SAVE]** → **[OFF]**

Answering the baby monitor

■ When monitoring with a handset:

Press **[↶]** to answer a call.

If you want to respond from the monitoring handset, press **[MUTE]**.

- The monitoring handset will answer calls automatically when the auto intercom feature is set to “On” (page 27).

Note:

- If you receive an outside call when communicating with the monitored handset, the interrupt tone sounds. To answer the call, press **[OFF]**, then press **[↶]**.

■ When monitoring from outside:

Answer the call.

If you want to respond from your monitoring phone, press **[#][1]** using tone dialing. You can turn off the baby monitor feature by pressing **[#][0]**.

Note:

- The unit disconnects the call automatically after 2 minutes.

Other programming

Changing the handset name

The default handset name is “Handset 1” to “Handset 6”. You can customize the name

of each handset (“Bob”, “Kitchen”, etc.). This is useful when you make intercom calls between handsets. To display the handset name in standby mode, turn on the handset name display feature (page 51).

- 1 **[MENU][#][1][0][4]**
- 2 Enter the desired name (10 characters max.). → **[SAVE]** → **[OFF]**

Displaying the handset name

You can select whether or not the handset name is displayed in standby mode. The default setting is “off”.

- 1 **[MENU][#][1][0][5]**
- 2 **[↕]**: Select the desired setting. → **[SAVE]** → **[OFF]**

Registering a unit

Operating additional units

Additional handsets

Up to 6 handsets can be registered to the base unit.

Important:

- See page 4 for information on the available model.

Registering a handset to the base unit

The supplied handset and base unit are pre-registered. If for some reason the handset is not registered to the base unit, re-register the handset.

- 1 **Handset:**
[MENU][#][1][3][0]
- 2 **Base unit:**
Press and hold **[LOCATOR]** for about 5 seconds.
 - If all registered handsets start ringing, press **[LOCATOR]** again to stop, then repeat this step.

Programming

- 3 Handset:**
Press **[OK]**, then wait until a long beep sounds.

Deregistering a handset

A handset can cancel its own registration to the base unit, or other handsets registered to the same base unit. This allows the handset to end its wireless connection with the system.

- 1 [MENU]#131**
 - All handsets registered to the base unit are displayed.
- 2 [↕]:** Select the handset you want to cancel. → **[SELECT]**
- 3 [↕]:** “Yes” → **[SELECT]** → **[OFF]**

Using Caller ID service

Important:

- This unit is Caller ID compatible. To use Caller ID features, you must subscribe to a Caller ID service. Contact your phone service provider for details.

Caller ID features

When an outside call is being received, the caller information is displayed.

Caller information for the last 50 callers is logged in the caller list from the most recent call to the oldest.

- If the unit cannot receive caller information, the following is displayed:
 - “**Out of area**”: The caller dials from an area which does not provide a Caller ID service.
 - “**Private caller**”: The caller requests not to send caller information.
 - “**Long distance**”: The caller makes a long distance call.
- If the unit is connected to a PBX system, caller information may not be properly received. Contact your PBX supplier.

Missed calls

If a call is not answered, the unit treats it as a missed call. The display shows “**Missed call**”.

Note:

- Even when there are unviewed missed calls, “**Missed call**” disappears from the standby display if the following operation is performed by one of the units:
 - A handset is replaced on the base unit or charger.
 - Pressing [**OFF**] on a handset.

Phonebook name display

When caller information is received and it matches a phone number stored in the phonebook, the stored name in the phonebook is displayed and logged in the caller list.

Talking Caller ID

Handset / Base unit

This feature lets you know who is calling without looking at the display.

To use this feature, you must:

- subscribe to a Caller ID service of your phone service provider.
- turn this feature on (page 44).

When caller information is received, the handsets and/or base unit announce the caller’s name or phone number received from your phone service provider following every ring.

- Name pronunciation may vary. This feature may not pronounce all names correctly.
- Caller ID service has a limit of how many characters can be displayed. If the caller’s name is too long, the unit may not be able to display or announce the entire name.

Phonebook name announcement

When caller information is received and it matches a phone number stored in the phonebook, the stored name in the phonebook is announced.

Caller list

Important:

- Make sure the unit’s date and time setting is correct (page 16).

Viewing the caller list and calling back

■ Using a cellular line

- 1 [**▼**] CID
- 2 Press [**▼**] to search from the most recent call, or [**▲**] to search from the oldest call.
- 3 To call back, press [**SELECT**]. To exit, press [**OFF**].
- 4 [**CELL**]
 - If you select an entry with “**☎#**”, “**☎**” or “**△**” displayed, an error tone sounds.

Caller ID Service

Wait for 2 seconds until a confirmation message is displayed. Press **[YES]** if you want to call back.

- The unit starts dialing immediately in the following situations.
 - Only 1 cellular phone is paired.
 - A specific line is set to make cellular calls (page 21).

5 **[↕]**: Select the desired cellular phone. → **[SELECT]**

■ Using a landline

1 **[▼]** CID

2 Press **[▼]** to search from the most recent call, or **[▲]** to search from the oldest call.

3 To call back, press **[↶]**.

- If you select an entry with “**☎#**”, “**☎☎**” or “**☎**” displayed, an error tone sounds.

Wait for 2 seconds until a confirmation message is displayed. Press **[YES]** if you want to call back.

To exit, press **[OFF]**.

Note:

- If the entry has already been viewed or answered, “**✓**” is displayed.
 - **☎1** or **☎2** indicates the caller information was received from the cellular line.
 - “**☎#**” or “**☎☎**” indicates the caller information for blocked calls.
 - “**☎**” indicates the caller information for scam calls.

Editing a caller's phone number

You can edit a phone number in the caller list by removing its area code and/or the long distance code “1”.

■ When a cellular phone is paired:

1 **[▼]** CID

2 **[↕]**: Select the desired entry. → **[SELECT]**

3 Press **[X]** (Edit) repeatedly until the phone number is shown in the desired format.

4 Using a cellular line:

To make a cellular call, continue from step 4, “Viewing the caller list and calling back”, page 53.

Using a landline:

[↶]

■ When a cellular phone is not paired:

1 **[▼]** CID

2 **[↕]**: Select the desired entry. → **[MENU]**

3 **[↕]**: “**Edit**” → **[SELECT]**

4 Press **[EDIT]** repeatedly until the phone number is shown in the desired format.

5 **[↶]**

Caller ID number auto edit feature

Once you call back an edited number, the unit which was used to call back remembers the area code and format of the edited number. The next time someone calls from the same area code, caller information is customized by the unit as follows:

- When the call is being received, the Caller ID number is displayed in the same format as the edited number.
- After the call has ended, the caller's phone number is displayed in the same format as the edited number, when reviewed from the caller list.

For example, you can use this feature to set the unit to ignore the area code of callers in your area, so that you can call these local numbers using caller information without dialing the area code.

To activate this feature, you must edit an entry in the caller list, then call that number. After that, phone numbers from that caller's area code are edited automatically. This feature can be set for each unit (page 46). The default setting is “**On**”.

Note:

- Phone numbers from the 4 most recently edited area codes are automatically edited.

Erasing selected caller information

- 1 [▼] CID
- 2 [↕]: Select the desired entry.
- 3 [ERASE] → [↕]: “Yes” → [SELECT] → [OFF]

Erasing all caller information

- 1 [▼] CID
- 2 [ERASE] → [↕]: “Yes” → [SELECT] → [OFF]

Copying phonebook from a cellular phone (phonebook transfer)

You can copy phonebook entries from the paired cellular phones or other cellular phones (not paired) to the unit's phonebook. A cellular phone must be compatible with Bluetooth wireless technology.

Important:

- Your cellular phone must support Phone Book Access Profile (PBAP) or Object Push Profile (OPP) specification.
- If a copied entry has 2 or more phone numbers, each phone number (6 max.) is stored as a separate entry with the same name.
- If a phonebook entry includes additional data such as a picture, that entry may fail to copy to the base unit.
- If your cellular phone includes international call entries, set the conversion codes before copying (page 56).

1 Handset:

[MENU] **#** **6** **1** **8**

2 Handset:

To copy from paired cellular phones:

[↕]: Select the desired cellular phone. → **[SELECT]**

- Copied items are stored to the group ("Cell 1" or "Cell 2") which the cellular phone is paired to.

To copy from other cellular phones (not paired):

[↕]: "Other cell" → **[SELECT]** → **[↕]**: Select the group you want to copy to. → **[SELECT]**

3 Handset:

When "Use the cell to transfer phone book" is displayed: Go to step 4.

When "Select mode" menu is displayed:

[↕]: Select "Auto" or "Manual". → **[SELECT]**

"Auto": Download all entries from the cellular phone automatically. Go to step 5.

"Manual": Copy entries you selected.

- "Select mode" menu is displayed only when the cellular phone supports Phone Book Access Profile (PBAP) for Bluetooth connection.
- Some cellular phones may require you to perform an operation on the cellular phone even if you select "Auto".

4 Cellular phone:

Follow the instructions of your cellular phone to copy phonebook entries.

- For other cellular phones (not paired), you need to search for and select the base unit. The Bluetooth PIN (default: "0000") may be required. If your cellular phone shows PassKey confirmation on its display, follow the directions to proceed.
- The entries being copied are displayed on the handset.

5 Handset:

Wait until "Completed" is displayed.

- You can continue copying other entries if necessary.

6 Handset: [OFF]

Note:

- Some copied entries may have characters which are not available. These characters can be displayed but cannot be entered when editing an entry.
- The unit does not support some characters. If a copied entry includes those characters, they are replaced with other available characters or "*".
- If you receive a call while copying phonebook entries, the copying procedure stops. Try again after finishing the call.

Setting conversion codes

You must first set the following 3 dialing codes before transferring the phonebook from your cellular phone (4 digits max. each).

- "International code": An international prefix used when you make an international call.
- "Country code": Your country code for international calls.

Using Bluetooth® Devices

- “**Trunk prefix**”: A trunk prefix; the initial digit(s) to be dialed in a domestic call, prior to the area code.

- 1 [MENU]**
- 2** To store “**International code**”:
[1] [7]
To store “**Country code**”: # [1] [8]
To store “**Trunk prefix**”: # [1] [9]
- 3** Enter the desired number. → [SAVE]
→ [OFF]

Note:

- After you copy the entries, confirm that the numbers were transferred correctly.

Link to Cell app

For Android™ users

The free Link to Cell app helps you integrate your Android phone with your DECT phone for convenient use.

Important:

- Your cellular phone must support Serial Port Profile (SPP) specification.
- **Application (App) Alerts On/Off**
This feature alerts your DECT phone when your paired Android phone receives the following alert information:
 - [Google Calendar]™
 - [Gmail]™
 - [Text messages]
 - [Facebook]
 - [Twitter]
 - [Instagram]
 - [Low Battery] information

Please check the latest information for details on functions that can be alerted at the web page below.

<https://panasonic.net/cns/pcc/support/tel/appalerts/>

You can turn each type of alert on or off using the Link to Cell app. If you turn the alerting app on, your DECT phone alerts you with the corresponding information.

■ Phone Settings

Using your paired Android phone, you can program your Phone Settings for the following features:

- [Time adjustment]*1
- [Cell line only mode] (page 20)
- [International code], [Country code], and [Trunk prefix] (page 56)

*1 When your paired Android phone is within the base unit's range, the date and time information is updated on the handset's display, if time adjustment feature is activated on your Android phone.

Installing the Link to Cell app

Download links are also available at the web page below.



<https://panasonic.net/cns/pcc/support/tel/appalerts/>



Starting the app for the first time

- 1** Make sure that your Android device's Bluetooth feature is turned on and that your Android device is paired to the base unit.
- 2** Start the Link to Cell app by tapping its icon.
- 3** Follow the on-screen instructions.

Important:

- For further information, refer to the instructions on web page listed above.

For assistance, please visit <http://shop.panasonic.com/support>

57

Using Bluetooth® Devices

- To use this feature, the following settings are required.
 - **Android phone:** Bluetooth must be turned on.
 - **Android phone:** [Application Alerts manager] must be turned on.
 - **Handset:** “Alert On/Off” must be turned on (page 58).
- If this feature does not work, turn on your device’s Bluetooth feature, unplug the base unit’s AC adaptor, and then reconnect it.
- If this feature still does not work properly after performing the above operation, re-install the Link to Cell app.

Text message (SMS) alert

For iPhone® users

This feature alerts you on your DECT phone when your paired cellular phone receives SMS messages. The Link to Cell app is not required for iPhone users.

Important:

- Your cellular phone must support Message Access Profile (MAP) specification.
- For further information, refer to the instructions on web page listed below: www.panasonic.net/pcc/support/tel/sms/
- To use this feature, the following settings are required:
 - **iPhone:** Bluetooth must be turned on.
 - **Handset:** “Alert On/Off” must be turned on (page 58).
- If this feature does not work, turn on your device’s Bluetooth feature, unplug the base unit’s AC adaptor, and then reconnect it.

Alert settings for your DECT phone

If your cellular phone is paired to the base unit and receives notifications, the handset can alert you:

- by briefly displaying a message
- by announcement
- by sounding alert tones

Important:

- For Android users: Use the Link to Cell app to enable the desired alerts (page 57).

Turning alert on/off

Once this feature is turned on, it will alert you on the handset when your cellular phone receives notifications.

- “On” (default): The handset alerts you.
- “Off”: The handset does not alert you.

- 1 For CELL 1: [MENU] # 6 1 0 1
For CELL 2: [MENU] # 6 1 0 2
- 2 [↕]: Select the desired setting. →
[SAVE] → [OFF]

Setting the voice alert

You can turn on/off the voice alert.

- “On” (default): The handset notifies you by voice announcement.
- “Off”: Voice announcement is not available as alert.

- 1 For CELL 1: [MENU] # 6 0 3 1
For CELL 2: [MENU] # 6 0 3 2
- 2 [↕]: Select the desired setting. →
[SAVE] → [OFF]

Selecting the alert tone

- 1 For CELL 1: [MENU] # 6 0 4 1
For CELL 2: [MENU] # 6 0 4 2
- 2 [↕]: Select the desired setting. →
[SAVE] → [OFF]

Remote voice assist

For iPhone® and Android™ smartphone users

You can use the handset to operate the voice recognition feature of a paired cellular phone (Siri® or Google Assistant™). For example, you can speak into the handset and command your cellular phone to make a call.



Compatible voice recognition features

- Google Assistant (Android 4.0 or later)
- Siri (iOS 8.0 or later)

Important:

- Your cellular phone must support the Hands Free Profile (HFP) specification.
- In order to use this feature, your cellular phone's voice recognition feature must be ready to use.
 - iPhone: Make sure Siri is turned on.
 - Android: In order to use Google Assistant, make sure your cellular phone is registered to your Google account.
- If you have multiple voice recognition features available for your cellular phone, you may need to set the desired voice recognition feature as the default.
- For Android users: Depending on your cellular phone, you may need to set Google Assistant as your cellular phone's default voice recognition feature. For more information, refer to the operating instructions of your cellular phone.

Activating remote voice assist

- 1 
 - Go to step 3 in the following situations.
 - Only 1 cellular phone is paired.
 - A specific line is set to make cellular calls (page 21).
- 2 : Select the desired cellular phone. → **[SELECT]**
- 3 Wait until "voice assist" is displayed.
 - A confirmation tone sounds.
 - Speakerphone is turned on automatically.
 - To switch to the receiver, press .
- 4 Speak your commands to your handset.
 - When you have finished using remote voice assist, press **[OFF]**.

Note:

- While using this feature, you cannot use another handset to make a cellular call using the same cellular line.
- If you receive a call on the landline or on another cellular line while using this feature, the interrupt tone sounds.

- If you receive a call on the same cellular line while using this feature, voice recognition ends and the unit receives the incoming call.
- If your cellular phone is connected to the base unit, you may not be able to use your cellular phone's microphone to operate its voice recognition feature. In this case, disconnect your cellular phone from the base unit.
- The compatible voice commands depends on the cellular phone voice recognition feature.

Using a Bluetooth headset (optional)

By pairing a Bluetooth headset to the base unit, you can enjoy hands-free conversations when talking on landline calls.

Important:

- Your Bluetooth headset must support the Headset Profile (HSP) specification.
- Only 1 Bluetooth headset can be paired to the base unit.
- Only 1 Bluetooth device can be used with the unit at a time*1.
- For best performance, we recommend using your Bluetooth headset within 1 m (3.3 feet) of the base unit. The base unit can communicate with Bluetooth headsets within an approximately 10 m (33 feet) range.

*1 You cannot use a Bluetooth headset to talk on a cellular line.

Pairing a Bluetooth headset to the base unit

Important:

- Make sure that the Bluetooth headset is not connected to any other Bluetooth device.

1 Bluetooth headset:

Set your headset to pairing mode.

- Refer to the headset's operating instructions.

Using Bluetooth® Devices

- Handset:**
[MENU] [#] [6] [2] [1]
- If your headset PIN is "0000", go to step 4.
If your headset PIN is not "0000", press [CLEAR], then enter your headset's PIN.
 - Typically, default PIN is "0000". Refer to the headset's operating instructions.
- Press [OK], then wait until a long beep sounds.
- [OFF]
 - When the Bluetooth headset is ready for use, the HEADSET indicator on the base unit lights up.

Connecting/disconnecting a Bluetooth headset

If you cannot connect the headset and base unit using the headset, you can connect using the handset.

To use your headset with another Bluetooth device such as a cellular phone, you may need to disconnect it from the base unit.

Important:

- Make sure that the headset is turned on.

- To connect/disconnect:**
[MENU] [#] [6] [2] [2]
 - A long beep sounds.
- [OFF]

Unpairing a Bluetooth headset

You can cancel a pairing of the headset that is stored to the base unit.

- [MENU] [#] [6] [1] [2]
- [↕]: "Yes" → [SELECT]
 - When the headset is unpaired, the HEADSET indicator is turned off.
- [OFF]

Operating a Bluetooth headset using a landline

Important:

- Refer to your headset's operating instructions for details.
- Some features described here may not be available depending on Bluetooth headset.

Answering landline calls with your headset

To answer a landline call, press your headset's button.

When you finish talking, press your headset's button.

Note:

- If you cannot hang up the call using your headset, press [▶■] (STOP) on the base unit.

Call sharing between your headset and the handset

Important:

- To activate this feature, you should set call sharing mode to on beforehand (page 46).
- While the handset is on a landline call:**
To join the conversation with your headset, press your headset's button.
- While your headset is on a landline call:**
To join the conversation with the handset, press [↶].

Switching between the base unit and your headset

You can switch from the base unit to your headset while listening to messages recorded on the base unit answering system.

- You can only switch from the base unit to your headset.
- To switch to your headset:**
Press your headset's button.

Adjusting your headset receiver volume

Base unit

Press **[+]** or **[-]** repeatedly while using your headset.

Note:

- Depending on your headset, the receiver volume may not be adjustable.

Answering System for Landline

Answering system for landline

The answering system can answer and record calls for you when you are unavailable to answer the phone.

The unit can be set to play a greeting message but not to record caller messages by selecting “**Greeting only**” as the recording time setting (page 67).

You can also record phone conversations (page 25).

Important:

- Make sure the unit's date and time setting is correct (page 16).

Memory capacity (including your greeting message)

The total recording capacity is about 18 minutes. A maximum of 64 messages can be recorded.

Note:

- When message memory becomes full:
 - “**Messages full**” is shown on the handset display.
 - The message counter on the base unit flashes if the answering system is turned on.
 - If you use the pre-recorded greeting message, the unit automatically switches to another pre-recorded greeting message asking callers to call again later.
 - If you recorded your own greeting message, the same message is still announced to callers even though their messages are not recorded.

Turning the answering system on/off

Base unit

Press **[ANSWER ON/OFF]** to turn on/off the answering system.

Handset

1 To turn on:
[MENU]#[3][2][7]

To turn off:
[MENU]#[3][2][8]

2 [OFF]

Note for base unit and handset:

- When the answering system is turned on, the message counter on the base unit displays the total number of messages (old and new).

Greeting message

When the unit answers a call, a greeting message is played to callers.

You can use either:

- your own greeting message
- a pre-recorded greeting message

Recording your greeting message

1 [MENU]#[3][0][2]

2 [↕]: “yes” → [SELECT]

3 After a beep sounds, speak clearly about 20 cm (8 inches) away from the microphone (2 minutes max.).

4 Press **[STOP]** to stop recording. → **[OFF]**

Using a pre-recorded greeting message

The unit provides 2 pre-recorded greeting messages:

- If you reset to pre-recorded greeting or do not record your own greeting message, the unit plays a pre-recorded greeting asking callers to leave a message.
- If the message recording time (page 67) is set to “**Greeting only**”, callers' messages are not recorded and the unit plays a different pre-recorded greeting message asking callers to call again.

Answering System for Landline

Resetting to a pre-recorded greeting message

Use this procedure to erase your greeting message and use a pre-recorded one.

- 1 [MENU] [#] 3 0 4
- 2 [YES] → [OFF]

Playing back the greeting message

- 1 [MENU] [#] 3 0 3
- 2 To exit, press [OFF].

Listening to messages

Important:

- When using the base unit or handset to listen to messages, the noise reduction feature (page 24) is activated automatically in spite of the setting ([NR] is not displayed).

Using the base unit

When new messages have been recorded, the message indicator (▶) on the base unit flashes.

Press [▶] (PLAY).

- During playback, the message indicator (▶) on the base unit lights.
- If new messages have been recorded, the base unit plays back new messages.
- If there are no new messages, the base unit plays back all messages.

Operating the answering system during playback

Key	Operation
[+] or [-]	Adjust the speaker volume
[◀◀]	Repeat message*1
[▶▶]	Skip message
[▶] (STOP)	Stop playback

Key	Operation
[ERASE]	Erase currently playing message

- *1 If pressed within the first 5 seconds of a message, the previous message is played.

Erasing all messages

Press [ERASE] 2 times while the unit is not in use.

Using the handset

When new messages have been recorded, "New message" is displayed.

- 1 To listen to new messages:
[MENU] [#] 3 2 3
To listen to all messages:
[MENU] [#] 3 2 4

- 2 When finished, press [OFF].

Note:

- To switch to the receiver, press [↶].
- You can also use the [PLAY] soft key, if displayed, to play new messages.

Operating the answering system

[MENU] → [⬆]: "Answering device" → [SELECT]

Key	Operation
[▲] or [▼]	Adjust the receiver/speaker volume (during playback)
[1] or [◀]	Repeat message (during playback)*1
[2] or [▶]	Skip message (during playback)
[3]	Enter the "Settings" menu
[4]	Play new messages
[5]	Play all messages
[6]	Play greeting message
[7] [6]	Record greeting message
[8]	Turn answering system on
[PAUSE]	Pause message*2

For assistance, please visit <http://shop.panasonic.com/support>

Answering System for Landline

Key	Operation
[9] or [STOP]	Stop recording Stop playback
[0]	Turn answering system off
[*][4]*3	Erase currently playing message
[*][5]	Erase all messages
[*][6]	Reset to a pre-recorded greeting message

- *1 If pressed within the first 5 seconds of a message, the previous message is played.
- *2 To resume playback:
[↕]: "Playback" → [SELECT]
- *3 You can also erase as follows:
[PAUSE] → [↕]: "Erase" → [SELECT] → [↕]: "Yes" → [SELECT]

Calling back (Caller ID subscribers only)

- Using a landline:
- 1 Press [PAUSE] during playback.
 - 2 [↕]: "Call back" → [SELECT]
- Using a cellular line:
- 1 Press [PAUSE] during playback.
 - 2 [↕]: "Call back (Cell)" → [SELECT]
 - The unit starts dialing immediately in the following situations.
 - Only 1 cellular phone is paired.
 - A specific line is set to make cellular calls (page 21).
 - 3 [↕]: Select the desired cellular phone. → [SELECT]

Editing the number before calling back

- Using a landline:
- 1 Press [PAUSE] during playback.
 - 2 [↕]: "Edit & Call" → [SELECT]
 - 3 Press [EDIT] repeatedly until the phone number is shown in the desired format (page 54).
 - 4 [↶]

■ Using a cellular line:

- 1 Press [PAUSE] during playback.
- 2 [↕]: "Edit & Call" → [SELECT]
- 3 Press [EDIT] repeatedly until the phone number is shown in the desired format (page 54).
- 4 [CELL]
 - The unit starts dialing immediately in the following situations.
 - Only 1 cellular phone is paired.
 - A specific line is set to make cellular calls (page 21).
- 5 [↕]: Select the desired cellular phone. → [SELECT]

Erasing all messages

- 1 [MENU][#][3][2][5]
- 2 [↕]: "Yes" → [SELECT] → [OFF]

Advanced new message alerting features

Audible message alert

This feature allows the base unit to beep to inform you of a new message arrival when new messages are recorded. The base unit beeps 2 times every minute until you listen to the messages, if the "Base unit beep" setting is turned on. The default setting is "Off".

- 1 [MENU][#][3][3][9]
- 2 [↕]: Select the desired setting. → [SAVE]
- 3 [OFF]

New message alert by a call

This feature allows you to receive a notification by phone when new messages are recorded. The base unit calls a phone number you specify. You can then operate the answering system remotely to listen to the new message.

Answering System for Landline

To use this feature, you must:

- store a phone number to which the unit makes the call to.
 - turn on the new message alert setting.
- After you answer the new message alert call, you can listen to messages from that call (page 65).

This feature is only available for landline.

Important:

- A new message alert is stopped 1 minute after the unit starts to call. The unit will not retry the call even if the call is not answered.

Storing a phone number to which the unit makes an alert call

■ From the phonebook:

- 1 [MENU]#338
- 2 [↕]: “Notification to” → [SELECT] → [ADD]
- 3 [↕]: “Phonebook” → [SELECT]
- 4 [↕]: Select the desired phonebook entry. → [SAVE] → [OFF]

■ By entering a phone number:

- 1 [MENU]#338
- 2 [↕]: “Notification to” → [SELECT] → [ADD]
- 3 [↕]: “Manual” → [SELECT]
- 4 Enter the desired name (16 characters max.). → [OK]
- 5 Enter the desired number (24 digits max.). → [OK] → [SELECT] → [OFF]

Turning on/off the new message alert setting

- 1 [MENU]#338
- 2 [↕]: “On/Off” → [SELECT]
- 3 [↕]: Select the desired setting. → [SAVE]
- 4 [OFF]

Editing the set phone number

- 1 [MENU]#338

- 2 [↕]: “Notification to” → [SELECT]
- 3 [MENU] → [↕]: “Edit” → [SELECT]
- 4 Edit the name if necessary (16 characters max.). → [OK]
- 5 Edit the phone number if necessary (24 digits max.). → [OK] → [SELECT] → [OFF]

Erasing the set phone number

- 1 [MENU]#338
- 2 [↕]: “Notification to” → [SELECT]
- 3 [MENU] → [↕]: “Erase” → [SELECT]
- 4 [↕]: “Yes” → [SELECT] → [OFF]
 - The new message alert setting is turned off.

Activating/inactivating the remote access code to play messages

If you activate this feature, you must enter the remote access code (page 66) to play the new message from the new message alert call. This is so that unauthorized parties cannot listen to your messages. The default setting is “Inactivate”.

- “Inactivate”: You can listen to the message by pressing [4] to play new messages (without entering the remote access code).
- “Activate”: You must enter your remote access code and then press [4] to play new message.

- 1 [MENU]#338
- 2 [↕]: “Remote code” → [SELECT]
- 3 [↕]: Select the desired setting. → [SAVE]
- 4 [OFF]

Listening to messages

After you answer the new message alert, you can listen to the messages as follows.

- **When the remote access code is set to “Inactivate”:**
Press [4] to play the new message during the announcement.

Answering System for Landline

■ When the remote access code is set to "Activate":

- 1 Enter the remote access code (page 66) during the announcement.
- 2 Press **[4]** to play the new message.

Note:

- Within 10 seconds after listening to new messages, you can press **[#][9]** during the call to turn off the new message alert by a call feature.
- Even if the unit makes a new message alert call, the handset redial list does not show the record.

Remote operation

Using a touch-tone phone, you can call your phone number from outside and access the unit to listen to messages or change answering system settings. The unit's voice guidance prompts you to press certain dial keys to perform different operations.

Remote access code

A 3-digit remote access code must be entered when operating the answering system remotely. This code prevents unauthorized parties from listening to your messages remotely. The default setting is "111".

Important:

- To prevent unauthorized access to this product, we recommend that you regularly change the remote code.

- 1 **[MENU][#][3][0][6]**
- 2 Enter the desired 3-digit remote access code. → **[SAVE]** → **[OFF]**

Deactivating remote operation

Press **[X]** in step 2 on "Remote access code", page 66.

- The entered remote access code is deleted.

Using the answering system remotely

- 1 Dial your landline phone number from a touch-tone phone.
- 2 After the greeting message starts, enter your remote access code.
- 3 Follow the voice guidance prompts as necessary or control the unit using remote commands (page 66).
- 4 When finished, hang up.

Voice guidance

■ When the English voice guidance is selected

During remote operation, the unit's voice guidance starts and prompts you to press **[1]** to perform a specific operation, or press **[2]** to listen to more available operations.

■ When the Spanish voice guidance is selected

To start the voice guidance, press **[9]**. The voice guidance announces the available remote commands (page 66).

Note:

- If you do not press any dial keys within 10 seconds after a voice guidance prompt, the unit disconnects your call.

Remote commands

You can press dial keys to access certain answering system functions without waiting for the voice guidance to prompt you.

Key	Operation
[1]	Repeat message (during playback)*1
[2]	Skip message (during playback)
[4]	Play new messages
[5]	Play all messages
[9]	Stop playback*2 Start voice guidance*3
[0]	Turn answering system off
[X][4]	Erase currently playing message

Answering System for Landline

Key	Operation
*1 5	Erase all messages
*1 #	End remote operation (or hang up)

- *1 If pressed within the first 5 seconds of a message, the previous message is played.
- *2 For English voice guidance only
- *3 For Spanish voice guidance only

Turning on the answering system remotely

- 1 Dial your phone number from a touch-tone phone.
- 2 Let the phone ring 15 times.
 - A long beep is heard.
- 3 Enter your remote access code within 10 seconds after the long beep.
 - The greeting message is played back.
 - You can either hang up, or enter your remote access code again and begin remote operation (page 66).

Answering system settings

Call screening

While a caller is leaving a message, you can listen to the call through the unit's speaker. To adjust the speaker volume, press **[▲]** or **[▼]** repeatedly.

You can answer the call by pressing **[📞]** on the handset.

Call screening can be set for each unit. The default setting is "On".

- 1 **[MENU]#310**
- 2 **[↕]**: Select the desired setting. → **[SAVE] → [OFF]**

Number of rings before the unit answers a call

You can change the number of times the phone rings "Ring count" before the unit

answers calls. You can select 2 to 7 rings, or "Toll saver".

The default setting is "4 rings".

"Toll saver": The unit's answering system answers at the end of the 2nd ring when new messages have been recorded, or at the end of the 5th ring when there are no new messages. If you call your phone from outside to listen to new messages (page 66), you know that there are no new messages when the phone rings for the 3rd time. You can then hang up without being charged for the call.

- 1 **[MENU]#211**
- 2 **[↕]**: Select the desired setting. → **[SAVE] → [OFF]**

Caller's recording time

You can change the maximum message recording time allowed for each caller. The default setting is "3 min".

- 1 **[MENU]#305**
- 2 **[↕]**: Select the desired setting. → **[SAVE] → [OFF]**

Selecting "Greeting only"

You can select "Greeting only" which sets the unit to announce a greeting message to callers but not record messages.

Select "Greeting only" in step 2 on "Caller's recording time", page 67.

Note:

- When you select "Greeting only":
 - If you do not record your own message, the unit will play the pre-recorded greeting-only message asking callers to call again later.
 - If you use your own message, record the greeting-only message asking callers to call again later (page 62).

Useful Information

Voice mail service for landline

In addition to your unit's answering system you may also have voicemail service from your phone service provider. Voicemail is an answering service that may be offered by your phone service provider. This service can also record calls when you are unavailable to answer the phone or when your line is busy. Messages are recorded on the phone company system and not on the unit's answering system.

- To use the voicemail service rather than the unit's answering system, turn off the answering system (page 62).

If you have unit's answering system set to on and also the voicemail enabled, the system with least amount of rings will record the message first.

Example:

If the unit's answering system is set to 4 rings (page 67) and the voicemail answering system provided by your phone company is set to 6 rings (call your service provider), the unit's answering system will record the incoming call first.

Storing the voicemail (VM) access number

In order to listen to your voicemail messages, you must dial your phone service provider's voicemail access number. Once you have stored your voicemail access number, you can dial it automatically (page 68).

- 1 **[MENU]#3331**
- 2 Enter your access number (24 digits max.). → **[SAVE]** → **[OFF]**

Note:

- When storing your voicemail access number and your mailbox password, press **[▲]** (Pause) to add pauses (page 23) between the access number and the password as necessary. Contact your phone service provider for the required pause time.

Example:

<u>1-222-333-4444</u>	<u>PPPP</u>	<u>8888</u>
VM access number	Pauses	Password

To erase the voicemail access number

- 1 **[MENU]#3331**
- 2 Press and hold **[CLEAR]** until all digits are erased. → **[SAVE]** → **[OFF]**

Voice mail (VM) tone detection

Your phone service provider sends special signals (sometimes called "voicemail tones" or "stutter tones") to the unit to let you know you have new voicemail messages. If you hear a series of dial tones followed by a continuous dial tone after you press **[↶]** on the handset, you have new voicemail messages. Soon after you hang up a call or after the phone stops ringing, your unit checks the phone line to see if new voicemail messages have been recorded.

Turn this feature off when:

- You do not subscribe to voicemail service.
- Your phone service provider does not send voicemail tones.
- Your phone is connected to a PBX.

If you are not sure which setting is required, contact your phone service provider.

Turning VM tone detection on/off

The default setting is "On".

- 1 **[MENU]#3332**
- 2 **[↕]**: Select the desired setting. → **[SAVE]** → **[OFF]**

Listening to voicemail messages

When new messages have been recorded, "Voicemail msg. via phone co." is displayed if message indication service is available.

- 1 **[MENU]#3330**
 - The speakerphone turns on.

Useful Information

- 2 Follow the pre-recorded instructions.
- 3 When finished, hang up.

Note:

- You can also use the **[ACCESS]** soft key, if displayed, to play new voicemail messages.
- If the handset still indicates there are new messages even after you have listened to all new messages, turn it off by pressing and holding **[#]** until the handset beeps.

Wall mounting

Note:

- Make sure that the wall and the fixing method are strong enough to support the weight of the unit.

Base unit

- 1 Lead the AC adaptor cord and telephone line cord through the hole in the wall mounting adaptor in the direction of the arrow.

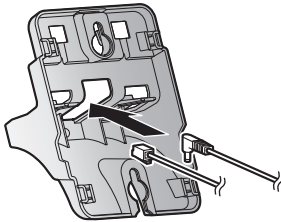

- 2 Tuck the telephone line cord inside the wall mounting adaptor (1). Connect the

AC adaptor cord and telephone line cord (2).

A AC adaptor cord

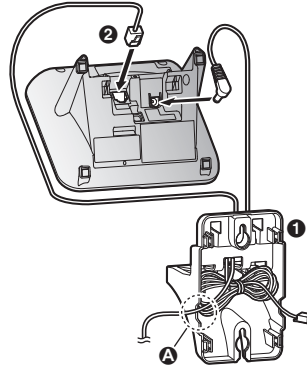

- 3 Insert the hooks on the wall mounting adaptor into holes (A) and (B) on the base unit.

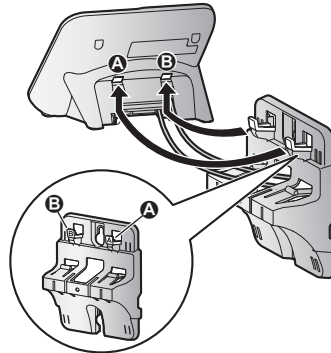

Useful Information

- 4 Adjust the adaptor to hold the base unit, then push it in the direction of the arrow until it clicks into place.

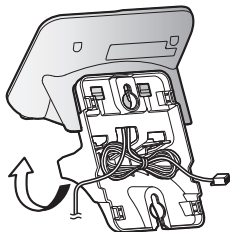
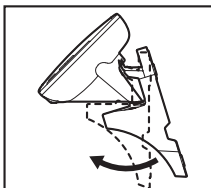

- 5 Mount the unit on a wall then slide down to secure in place.

A AC adaptor cord

- This product is compliant with the following wall phone plate sizes (2 types).

B 83 mm (3 1/4 inches)

C 102 mm (4 inches)

Fit the slots of the unit onto the corresponding wall phone plate tabs for **(D)** and **(E)** respectively.

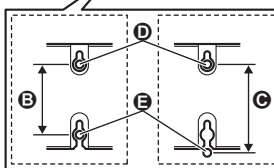
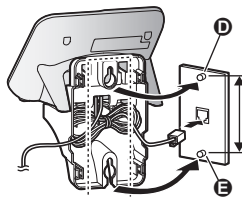
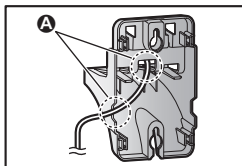

Useful Information

To remove the wall mounting adaptor

While pushing down the release levers (1), remove the adaptor (2).

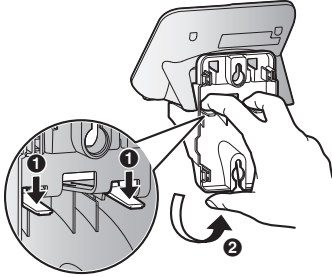

Charger

Drive the screws (A) (not supplied) into the wall.

B 27.2 mm (1 1/16 inches)

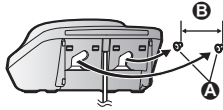

Useful Information

Error messages

Display message	Cause/solution
Ask phone company for VM access #	<ul style="list-style-type: none">You have not stored the voicemail access number. Store the number (page 68).
Main unit no power or No link. Reconnect base AC adaptor.	<ul style="list-style-type: none">Confirm the base unit's AC adaptor is connected to the unit and the power outlet correctly.The handset has lost communication with the base unit. Move closer to the base unit and try again.Unplug the base unit's AC adaptor to reset the unit. Reconnect the adaptor and try again.The handset's registration may have been canceled. Re-register the handset (page 51).
Busy	<ul style="list-style-type: none">No cellular phone is paired to the base unit. Pair a cellular phone (page 18).The called unit is in use.Other units are in use and the system is busy. Try again later.The handset you are using is too far from the base unit. Move closer and try again.The automated call block function is in operation. Try again later.One of the units is screening for telemarketing calls. Try again later.One of the units is recording a conversation with an outside caller. Try again later.Only 1 Bluetooth device can be used with the unit at a time. Try again later.The voice recognition feature could not be activated. Try again later.
Check tel line	<ul style="list-style-type: none">The supplied telephone line cord has not been connected yet or not connected properly. Check the connections (page 11).If you do not connect the telephone line cord and use only cellular lines, set the cellular line only mode (page 20).
Checking	<ul style="list-style-type: none">The automated call block function is in operation. Try again later.
Error!!	<ul style="list-style-type: none">Recording was too short. Try again.Someone is using a cellular line or headset. Try again later.The phonebook copy is incomplete (page 56). The cellular phone is disconnected from the base unit. Make sure that other Bluetooth devices are not connected to the cellular phone, and try again.

Useful Information

Display message	Cause/solution
Memory full	<ul style="list-style-type: none"> The recording memory is full. Erase unwanted recordings (page 64).
Failed	<ul style="list-style-type: none"> Although the unit tried to connect to the cellular phone or headset, the connection has been failed. <ul style="list-style-type: none"> Someone is using a cellular line or headset. Try again later. Make sure that the cellular phone or headset is not connected to other Bluetooth devices.
Invalid	<ul style="list-style-type: none"> There is no handset registered to the base unit matching the handset number you entered. The handset is not registered to the base unit. Register the handset (page 51).
Requires subscription to Caller ID.	<ul style="list-style-type: none"> You must subscribe to a Caller ID service. Once you receive caller information after subscribing to a Caller ID service, this message will not be displayed.
Use rechargeable battery.	<ul style="list-style-type: none"> A wrong type of battery such as alkaline or manganese was inserted. Use only the rechargeable Ni-MH batteries noted on page 4, 8.

Troubleshooting

If you still have difficulties after following the instructions in this section, disconnect the base unit's AC adaptor, then reconnect the base unit's AC adaptor. Remove the batteries from the handset, and then insert them into the handset again.

General use

Problem	Cause/solution
The handset does not turn on even after installing charged batteries.	<ul style="list-style-type: none"> Place the handset on the base unit or charger to turn on the handset.
The unit does not work.	<ul style="list-style-type: none"> Make sure the batteries are installed correctly (page 11). Fully charge the batteries (page 12). Check the connections (page 11). Unplug the base unit's AC adaptor to reset the unit. Reconnect the adaptor and try again. The handset has not been registered to the base unit. Register the handset (page 51).

Useful Information

Problem	Cause/solution
I cannot pair a cellular phone to the base unit.	<ul style="list-style-type: none"> Depending on the compatibility of the cellular phone, you may not be able to pair it to the base unit. Confirm that your cellular phone supports the hands-free profile (HFP) specification. Confirm that the Bluetooth feature of your cellular phone is turned on. You may need to turn this feature on depending on your cellular phone. The Bluetooth technology on your cellular phone may not be functioning normally. Turn off and on your cellular phone. If your cellular phone is already connected to another Bluetooth device such as a Bluetooth headset, turn it off or disconnect it from your cellular phone. Some cellular phones may require you to enter the Bluetooth PIN to pairing. Confirm that you entered the correct PIN.
I cannot connect a cellular phone to the base unit.	<ul style="list-style-type: none"> Confirm that your cellular phone is turned on. Confirm that your cellular phone is within base unit range (page 14). Your cellular phone's Bluetooth feature is turned off. Turn it on. Depending on the state of the wireless environment, such as the presence of any electrical interference, there may be a delay even if the auto connection feature is turned on. You can connect to the base unit manually (page 20). The cellular phone has not been paired to the base unit. Pair the cellular phone (page 18). If your cellular phone is already connected to another Bluetooth device such as a Bluetooth headset or other Panasonic DECT phone, disconnect the device, then perform the connecting procedure to the base unit. If your cellular phone is already registered on another Panasonic DECT phone, this function will not work properly. We strongly recommend that you remove the registration of this phone on both your cellular phone and on the other Panasonic DECT phone.
I cannot hear a dial tone.	<ul style="list-style-type: none"> The base unit's AC adaptor or telephone line cord is not connected. Check the connections. Disconnect the base unit from the telephone line and connect the line to a known working telephone. If the working telephone operates properly, contact our service personnel to have the unit repaired. If the working telephone does not operate properly, contact your phone service provider.
The base unit beeps.	<ul style="list-style-type: none"> New messages have been recorded. Listen to the new messages (page 63).
Error sound is heard when I press some keys on base unit.	<ul style="list-style-type: none"> Automated call block is being screened. Try again later.



Useful Information

Problem	Cause/solution
The unit does not emit the specified number of rings.	<ul style="list-style-type: none"> The number of rings decreases by 1 from the specified number of rings in below situations: <ul style="list-style-type: none"> the first ring is turned off (“No”) (page 30). answer by voice command is set to “On” (page 28).

Menu list

Problem	Cause/solution
The display is in a language I cannot read.	<ul style="list-style-type: none"> Change the display language (page 16).
I cannot register a handset to a base unit.	<ul style="list-style-type: none"> The maximum number of handsets (6) is already registered to the base unit. Cancel unused handset registrations from the base unit (page 52).

Battery recharge

Problem	Cause/solution
The handset beeps and/or  flashes.	<ul style="list-style-type: none"> Battery charge is low. Fully charge the batteries (page 12).
I fully charged the batteries, but <ul style="list-style-type: none">  still flashes,  is displayed, or the operating time seems to be shorter. 	<ul style="list-style-type: none"> Clean the battery ends (\oplus, \ominus) and the charge contacts with a dry cloth and charge again. It is time to replace the batteries (page 11).

Making/answering calls, intercom

Problem	Cause/solution
 is displayed.	<ul style="list-style-type: none"> The handset is too far from the base unit. Move closer. The base unit's AC adaptor is not properly connected. Reconnect AC adaptor to the base unit. The handset is not registered to the base unit. Register it (page 51).
Noise is heard, sound cuts in and out.	<ul style="list-style-type: none"> You are using the handset or base unit in an area with high electrical interference. Re-position the base unit and use the handset away from sources of interference. Move closer to the base unit. If you use a DSL/ADSL service, we recommend connecting a DSL/ADSL filter between the base unit and the telephone line jack. Contact your DSL/ADSL provider for details.

Useful Information

Problem	Cause/solution
The handset or base unit does not ring.	<ul style="list-style-type: none"> • The ringer volume for landline is turned off. Adjust the ringer volume (page 23, 44). • The ringer volume for cellular line is turned off. Adjust the ringer volume (page 23, 42). • The unit which is not selected to ring for cellular calls does not ring. To change the selection, see page 19. • Silent mode is turned on. Turn it off (page 49). • The ringer volume is turned off by pressing and holding [0] (✕). Press and hold [0] (✕) again to turn it on (page 23).
I cannot make local calls with the handset using a cellular line.	<ul style="list-style-type: none"> • You need to add your area code when making cellular calls. Store your area code in order to automatically add it to the beginning of the 7-digit phone number when making cellular calls (page 21).
I cannot make or answer cellular calls with the handset.	<ul style="list-style-type: none"> • Depending on the cellular phone's compatibility (page 5), you may not be able to make or answer cellular calls even if the cellular phone is connected to the base unit. • Make sure that the CELL indicator lights up and the cellular phone is connected to the base unit (page 20). • Only 1 Bluetooth device can be used with the unit at a time. • The cellular phone is being used separately from your system.
I can make and answer cellular calls but cannot hear a sound.	<ul style="list-style-type: none"> • The Bluetooth technology on your cellular phone may not be functioning normally. Turn off and on your cellular phone. • Disconnect and reconnect the base unit AC adaptor and try again.
I cannot switch cellular calls from the unit to the cellular phone.	<ul style="list-style-type: none"> • Your cellular phone may not support this feature. Refer to the operating instructions of your cellular phone.
I cannot make a call using a landline.	<ul style="list-style-type: none"> • The dialing mode may be set incorrectly. Change the setting (page 16).
I cannot use a cellular line.	<ul style="list-style-type: none"> • The unit cannot be used to talk on 2 cellular lines at the same time. Try again later.
The handset does not ring using the cellular phone's ringer tone even when the ring as cell mode is turned on.	<ul style="list-style-type: none"> • If answer by voice command is turned on, the units use the preset ringer tones (CELL 1: Tone 2, CELL 2: Tone 4) when receiving calls. To change the setting, see page 42, 44.
When you receive a call for a cellular line, the ringer volume is very low.	<ul style="list-style-type: none"> • Ringer volume in "Ring as cell mode" depends on the cellular phone Bluetooth output level specification. If ring as cell mode is set to "On (with Talking CID)" or "On (without Talking CID)", turn this feature off to use the ringer tones of the handset and base unit (page 19).

Useful Information

Problem	Cause/solution
I cannot answer an incoming call using voice commands.	<ul style="list-style-type: none"> • The answer by voice command feature is turned off. To turn it on, see page 28. • Baby monitor is set to “on”. Turn off the baby monitor feature (page 50).
The unit answers an incoming call on its own.	<ul style="list-style-type: none"> • This situation might happen due to a false detection of ambient noise (dog barking, TV sound, etc.). Move the unit further away from the noise sources. • If you are using other telephone that has Talking Caller ID feature turned on, it may also trigger false detection. Turn the Talking Caller ID feature off on the other telephone. • To minimize false detection, decrease the sensitivity level of the answer by voice command (page 28, 46).
I cannot make long distance calls.	<ul style="list-style-type: none"> • Make sure that you have long distance service.
I cannot use voice paging.	<ul style="list-style-type: none"> • You cannot use voice paging if other units are in use.

Call block

Problem	Cause/solution
The dedicated key for Telemarketing call block is not displayed.	<ul style="list-style-type: none"> • While on the charger, the [TELE.BLK.] key is not available. Lift the handset from the charger. • If the Auto talk feature is set to on, the call is answered automatically when the handset is lifted from the charger during an incoming call. Turn off the auto talk feature (page 46).

Caller ID/Talking Caller ID

Problem	Cause/solution
Caller information is not displayed.	<ul style="list-style-type: none"> • You must subscribe to Caller ID service. Contact your phone service provider for details. • If your unit is connected to any additional telephone equipment such as a Caller ID box or cordless telephone line jack, plug the unit directly into the wall jack. • If you use a DSL/ADSL service, we recommend connecting a DSL/ADSL filter between the base unit and the telephone line jack. Contact your DSL/ADSL provider for details. • The name display service for landline calls may not be available in some areas. Contact your phone service provider for details. • Other telephone equipment may be interfering with this unit. Disconnect the other equipment and try again.
Caller information is displayed or announced late.	<ul style="list-style-type: none"> • Depending on your phone service provider, the unit may display or announce the caller's information at the 2nd ring or later. • Move closer to the base unit.

For assistance, please visit <http://shop.panasonic.com/support>

77

Useful Information

Problem	Cause/solution
Caller information is not announced.	<ul style="list-style-type: none"> • The ringer volume for landline is turned off. Adjust the ringer volume (page 44). • The ringer volume for cellular line is turned off. Adjust the ringer volume (page 42). • The unit which is not selected to ring for cellular calls does not announce caller information. To change the selection, see page 19. • The Talking Caller ID feature is turned off. Turn it on (page 44). • The ring as cell mode is set to “On (without Talking CID)”. To change the mode, see page 19. • The number of rings for the answering system is set to “2 rings” or “Toll saver”. Select a different setting (page 67). • Your unit does not announce caller information while the other devices such as headset or handsets are engaged in a call.
The caller list/incoming phone numbers are not edited automatically.	<ul style="list-style-type: none"> • The Caller ID number auto edit feature is turned off. Turn it on and try again (page 46). • You need to call back the edited number to activate Caller ID number auto edit.
I cannot dial the phone number edited in the caller list.	<ul style="list-style-type: none"> • The phone number you dialed might have been edited incorrectly (for example, the long distance “1” or the area code is missing). Edit the phone number with another pattern (page 54).
Time on the unit has shifted.	<ul style="list-style-type: none"> • Incorrect time information from incoming Caller ID changes the time. Set the time adjustment to “Manual” (off) (page 44).
The 2nd caller’s information is not displayed during an outside call.	<ul style="list-style-type: none"> • In order to use Caller ID, call waiting, or Call Waiting Caller ID (CWID), you must first contact your phone service provider and subscribe to the desired service. After subscribing, you may need to contact your phone service provider again to activate this specific service, even if you already subscribed to both Caller ID and Call Waiting with Caller ID services (CWID).

Useful Information

Using Bluetooth devices

Problem	Cause/solution
I cannot copy phonebook entries from a cellular phone.	<ul style="list-style-type: none">● Confirm that the cellular phone supports Bluetooth wireless technology.● Confirm that the cellular phone supports the Phone Book Access Profile (PBAP) or Object Push Profile (OPP) specification.● If the cellular phone is already connected to another Bluetooth device such as a Bluetooth headset, turn it off or disconnect it from the cellular phone.● Someone is using a cellular line or headset. Try again later.● Turn the cellular phone off, then turn it on and try again.● If an entry is already stored in the unit's phonebook, the entry cannot be copied even by selecting another group.● iPhone does not support individual phonebook copy.
I cannot have a conversation using the headset. or I cannot connect my headset to the base unit.	<ul style="list-style-type: none">● Confirm that the Bluetooth wireless headset supports the HeadSet Profile (HSP) specification.● Your Bluetooth headset is not paired. Pair it (page 59).● Turn your headset off, then turn it on and try again.● If your headset is already connected to another Bluetooth device such as your cellular phone, disconnect the headset from your cellular phone, then perform the connecting procedure from the base unit.● Only 1 Bluetooth device can be used with the unit at a time.
Noise is heard during a call on the headset.	<ul style="list-style-type: none">● A Bluetooth headset can communicate with the base unit within a range of approximately 10 m (33 feet). The connection may be subject to interference from obstructions such as walls or electronic devices. Move closer to the base unit.
Some headset enhanced features are not available.	<ul style="list-style-type: none">● The base unit does not support enhanced features such as Last number redial or Call reject.
An error tone is heard when I try to program the Bluetooth feature.	<ul style="list-style-type: none">● The Bluetooth feature cannot be accessed immediately after connecting the AC adaptor to the base unit. Wait a few seconds and try again.● The headset has not connected to the base unit yet, even though you performed the connecting procedure setting. Wait a few seconds and try again.

Useful Information

Problem	Cause/solution
<p>App alert is not displayed or announced. or Text message alert is not displayed or announced.</p>	<ul style="list-style-type: none"> ● Confirm that the cellular phone supports the Message Access Profile (MAP) specification to use text message alert feature. ● Confirm that the cellular phone supports the Serial Port Profile (SPP) specification to use App alert feature. ● Confirm that the [Application Alerts manager] setting of your Android phone is turned on. ● “Alert On/Off” is set to “off”. Set it to “on” (page 58). ● “Voice alert” is set to “off”. Set it to “on” (page 58). ● The Bluetooth device’s Bluetooth notifications setting is turned off. ● The handset selected to display and/or announce alerts is in use. ● The Bluetooth device or its corresponding cellular line is in use. ● Your cellular phone’s Bluetooth feature is turned off. Turn it on. ● The unit which is not selected to ring for cellular calls does not ring. To change the selection, see page 19.
<p>Your cellular phone’s voice recognition feature does not start after pressing [].</p>	<ul style="list-style-type: none"> ● This feature may not be available when your cellular phone is in use. Try again later. ● If you cannot use this feature while your cellular phone is locked, unlock your phone and try again. ● For some cellular phones, you may be able to set your phone to allow its voice recognition feature to be used even when the phone is locked. For more information, refer to the operating instructions of your cellular phone. ● You may not be able to use this feature if other features or applications on your cellular phone are using Bluetooth features. Turn off these features or exit these applications, and then try again.
<p>The desired app does not start when you try to start the app using remote voice assist.</p>	<ul style="list-style-type: none"> ● In order to use this feature, your cellular phone’s voice recognition feature must be ready to use. <ul style="list-style-type: none"> – iPhone: Make sure Siri is turned on. – Android: In order to use Google Assistant, make sure your cellular phone is registered to your Google account. ● If you have multiple voice recognition features installed in your cellular phone, you may need to set the desired voice recognition feature as the default. If you cannot set the default, delete the other voice recognition features.

Useful Information

Answering system

Problem	Cause/solution
The unit does not record new messages.	<ul style="list-style-type: none">• The answering system is turned off. Turn it on (page 62).• The answering system does not answer or record calls from cellular lines.• The message memory is full. Erase unnecessary messages (page 63, 64).• The recording time is set to “Greeting only”. Change the setting (page 67).• Your phone service provider’s voicemail service may be answering your calls before the unit’s answering system can answer your calls. Change the unit’s number of rings setting (page 67) to a lower value, or contact your phone service provider.• The answering system will not answer incoming calls while the other devices such as headset or handsets are engaged in a call.
I cannot operate the answering system remotely.	<ul style="list-style-type: none">• The remote access code is not set. Set the remote access code (page 66).• You are entering the wrong remote access code. If you have forgotten your remote access code, enter the remote access code setting to check your current code (page 66).• The answering system is turned off. Turn it on (page 67).• You cannot operate the answering system when calling a cellular phone paired to the base unit.

Bluetooth PIN

Problem	Cause/solution
I cannot remember the PIN.	<ul style="list-style-type: none">• Change the PIN using the following method.<ol style="list-style-type: none">1 [MENU][#][6][1][9]2 [*][7][0][0][0]3 Enter the new 4-digit PIN. → [OK]4 Enter the new 4-digit PIN again. → [SAVE] → [OFF]

Useful Information

Voice mail

Problem	Cause/solution
<p>"Voicemail msg. via phone co." is shown on the handset display. How do I remove this message from the display?</p>	<ul style="list-style-type: none">• This notification is displayed when your phone service provider's voicemail service (not the unit's answering system) has recorded a message for you. Typically you can remove this notification from the display by listening to the message. To listen to the message, dial the voicemail number provided by your phone service provider (for most cases, this will be your own phone number), and follow the voice instructions. Depending on your phone service provider, you may need to remove all messages from your voice mailbox to remove the notification. You can also remove this notification by pressing and holding [#] until the unit beeps.

Liquid damage

Problem	Cause/solution
<p>Liquid or other form of moisture has entered the handset/base unit.</p>	<ul style="list-style-type: none">• Disconnect the AC adaptor and telephone line cord from the base unit. Remove the batteries from the handset and leave to dry for at least 3 days. After the handset/base unit are completely dry, reconnect the AC adaptor and telephone line cord. Insert the batteries and charge fully before use. If the unit does not work properly, contact an authorized service center.

Caution:

- To avoid permanent damage, do not use a microwave oven to speed up the drying process.

FCC and other information

This equipment complies with Part 68 of the FCC rules and the requirements adopted by the ACTA. On the bottom of this equipment is a label that contains, among other information, a product identifier in the format US:ACJ-----.

If requested, this number must be provided to the telephone company.

- Registration No.....(found on the bottom of the unit)
- Ringer Equivalence No. (REN).....0.1A

A plug and jack used to connect this equipment to the premises wiring and telephone network must comply with the applicable FCC Part 68 rules and requirements adopted by the ACTA. A compliant telephone cord and modular plug is provided with the product. It is designed to be connected to a compatible modular jack that is also compliant.

The REN is used to determine the number of devices that may be connected to a telephone line. Excessive RENs on a telephone line may result in the devices not ringing in response to an incoming call. In most but not all areas, the sum of RENs should not exceed five (5.0). To be certain of the number of devices that may be connected to a line, as determined by the total RENs, contact the local telephone company. For products approved after July 23, 2001, the REN for the product is part of the product identifier that has the format US:AAAEQ##TXXXX. The digits represented by ## are the REN without a decimal point (e.g., 03 is a REN of 0.3).

If this equipment causes harm to the telephone network, the telephone company will notify you in advance that temporary discontinuance of service may be required. But if advance notice isn't practical, the telephone company will notify the customer as soon as possible. Also, you will be

advised of your right to file a complaint with the FCC if you believe it is necessary.

The telephone company may make changes in its facilities, equipment, operations or procedures that could affect the operation of the equipment. If this happens the telephone company will provide advance notice in order for you to make necessary modifications to maintain uninterrupted service.

If trouble is experienced with this equipment, for repair or warranty information, please contact a Factory Service Center or other Authorized Servicer. If the equipment is causing harm to the telephone network, the telephone company may request that you disconnect the equipment until the problem is resolved.

Connection to party line service is subject to state tariffs. Contact the state public utility commission, public service commission or corporation commission for information.

If your home has specially wired alarm equipment connected to the telephone line, ensure the installation of this equipment does not disable your alarm equipment. If you have questions about what will disable alarm equipment, consult your telephone company or a qualified installer.

This equipment is hearing aid compatible as defined by the FCC in 47 CFR Section 68.316.

When you hold the phone to your ear, noise might be heard in your Hearing Aid. Some Hearing Aids are not adequately shielded from external RF (radio frequency) energy. If noise occurs, use an optional headset accessory or the speakerphone option (if applicable) when using this phone. Consult with your audiologist or Hearing Aid

Useful Information

manufacturer about the availability of Hearing Aids which provide adequate shielding to RF energy commonly emitted by digital devices.

WHEN PROGRAMMING EMERGENCY NUMBERS AND/OR MAKING TEST CALLS TO EMERGENCY NUMBERS:

- 1) Remain on the line and briefly explain to the dispatcher the reason for the call.
- 2) Perform such activities in the off-peak hours, such as early morning or late evenings.

This device complies with Part 15 of the FCC Rules. Operation is subject to the following two conditions:

(1) This device may not cause harmful interference, and (2) this device must accept any interference received, including interference that may cause undesired operation.

Privacy of communications may not be ensured when using this phone.

CAUTION:

Any changes or modifications not expressly approved by the party responsible for compliance could void the user's authority to operate this device.

NOTE:

This equipment has been tested and found to comply with the limits for a Class B digital device, pursuant to Part 15 of the FCC Rules. These limits are designed to provide reasonable protection against harmful interference in a residential installation. This equipment generates, uses, and can radiate radio frequency energy and, if not installed and used in accordance with the instructions, may cause harmful interference to radio communications. However, there is no guarantee that interference will not occur in a particular installation. If this equipment does cause harmful interference to radio or television reception, which can be determined by turning the equipment off and on, the user is

encouraged to try to correct the interference by one or more of the following measures:

- Reorient or relocate the receiving antenna.
- Increase the separation between the equipment and receiver.
- Connect the equipment into an outlet on a circuit different from that to which the receiver is connected.
- Consult the dealer or an experienced radio/TV technician for help.

Some cordless telephones operate at frequencies that may cause interference to nearby TVs and VCRs. To minimize or prevent such interference, the base of the cordless telephone should not be placed near or on top of a TV or VCR. If interference is experienced, move the cordless telephone further away from the TV or VCR. This will often reduce or eliminate interference.

FCC RF Exposure Warning:

- This product complies with FCC radiation exposure limits set forth for an uncontrolled environment.
- To comply with FCC RF exposure requirements, the base unit must be installed and operated 20 cm (8 inches) or more between the product and all person's body.
- This product may not be collocated or operated in conjunction with any other antenna or transmitter.
- For body-worn operation, the handset must be used only with a non-metallic accessory. Use of other accessories may not ensure compliance with FCC RF exposure requirements.

Notice:

- FCC ID can be found inside the battery compartment or on the bottom of the units.

Useful Information

Compliance with TIA-1083 standard:

Telephone handsets identified with this logo have reduced noise and interference when used with T-Coil equipped hearing aids and cochlear implants.



Guía Rápida Española

Conexiones

Unidad base

- ① Conecte el adaptador de corriente alterna a la unidad presionándolo firmemente.
- ② Conecte el adaptador de corriente alterna a la toma de corriente.
- ③ Conecte el cable de la línea telefónica a la unidad, y después a la toma telefónica de una sola línea (RJ11C) hasta que escuche un clic.
- ④ Se requiere un filtro DSL/ADSL (no incluido) si tiene este tipo de servicio.

Nota:

- Use solo el adaptador de corriente alterna Panasonic PNLV226 que se suministra.

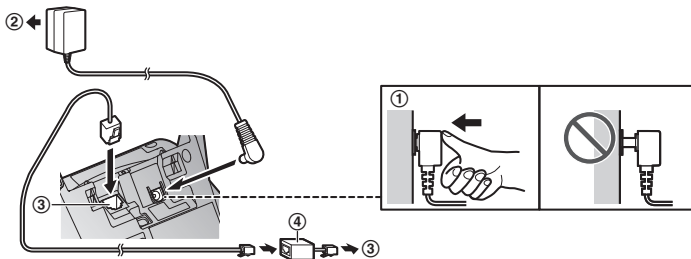

Cargador

- ① Conecte el adaptador de corriente alterna a la toma de corriente.

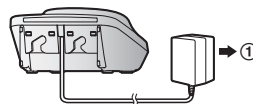

Instalación y carga y extracción de la batería

Cargue aproximadamente durante 7 horas.

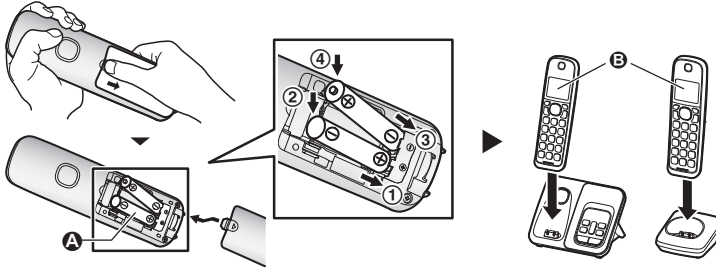

Nota:

- UTILICE SOLO baterías recargables de Ni-MH tamaño AAA (R03) (A).
- NO utilice baterías alcalinas, de manganeso ni de Ni-Cd.
- Confirme que las polaridades estén correctas (+, -).
- Cambie el idioma de la pantalla.
- Confirme que aparezca "Cargando" (B).

Extracción la batería

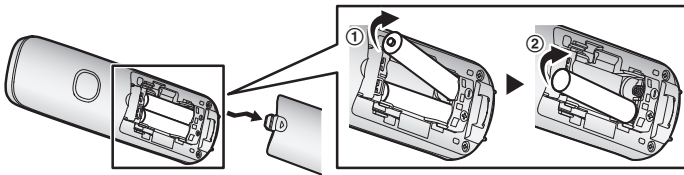

Sugerencias de operación

Teclas de función

Al oprimir una tecla de función, puede seleccionar la función que aparece directamente encima de ella en la pantalla. Preste atención a la pantalla para ver qué funciones están asignadas a las teclas de función durante la operación.



Tecla navegadora

- [▲], [▼], [◀] o [▶]: Navegue por diversas listas y elementos.
- VOL. (Volumen: [▲] o [▼]): Ajuste el volumen del receptor o el altavoz mientras habla.
- [◀] □ □: Vea la entrada del directorio telefónico.
- [▶] REDIAL (Remarcación): Vea la lista de remarcación.
- [▼] CID (Identificador de llamadas): Vea la lista de personas que llamaron.

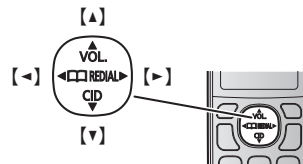

Para obtener ayuda, visite <http://shop.panasonic.com/support> (solo en inglés)

Guía Rápida Española

Cambio de idiomas (Auricular) (predeterminado: "English")

Cuando instale las baterías por primera vez, es posible que aparezca "Set date/time Press SELECT". Oprima [OFF] para salir.

Idioma de la pantalla

[MENU] [F1] [1] [0] → [↑]: "Español" → [GUARDAR] → [OFF]

Idioma de anuncio de voz

[MENU] [F1] [1] [2] → [↑]: "Español" → [GUARDAR] → [OFF]

Fecha y hora (Auricular)

1 [MENU] [F1] [0] [1]

2 Introduzca el día, mes y año actuales. → [OK]

3 Introduzca la hora y minuto actuales (formato de reloj de 24 horas).

4 [GUARDAR] → [OFF]

Cómo grabar el mensaje de saludo del contestador de llamadas para la línea terrestre (Auricular)

Puede grabar su propio mensaje de saludo en lugar de usar uno pregrabado.

1 [MENU] [F1] [3] [0] [2] → [↑]: "sí" → [SELEC.]

2 Después de que suene un pitido, hable con claridad en el micrófono a una distancia aproximada de 20 cm (8 pulgadas) (máx. de 2 minutos).

3 Oprima [PARAR] para dejar de grabar. → [OFF]

Enlace a celular

Puede conectar su unidad base y teléfono celular usando la tecnología inalámbrica Bluetooth®, para poder hacer o responder llamadas a su teléfono celular usando su sistema telefónico. Para obtener más detalles, visite nuestro sitio web: <http://shop.panasonic.com/bluetooth-phone>

- Coloque su teléfono celular cerca de la unidad base. Si su teléfono celular está demasiado cerca de la unidad base durante la llamada celular, es posible que escuche ruido. Para un mejor funcionamiento, le recomendamos que coloque su teléfono celular de 0.6 m a 3 m (2 pies a 10 pies) de la unidad base.



A Línea celular

B Proveedores de servicios de telefonía celular

Marcas registradas

- La marca denominativa y los logotipos de Bluetooth® son marcas registradas de Bluetooth SIG, Inc., y cualquier uso de dichas marcas por parte de Panasonic Corporation se hace bajo licencia.
- Todas las demás marcas comerciales que se identifican en el presente pertenecen a sus respectivos propietarios.

Enlace a celular



Cómo emparejar un teléfono celular con Bluetooth

- 1 Unidad base:**
Oprima y mantenga oprimido **[CELL 1]** o **[CELL 2]** durante aproximadamente 5 segundos.
- Después de que el indicador de CELL correspondiente comienza a parpadear en la unidad base, el resto del procedimiento debe completarse en menos de 5 minutos.
- 2 Su teléfono celular:**
Mientras el indicador de CELL correspondiente esté parpadeando, siga las instrucciones de su teléfono celular para entrar al modo de emparejamiento.
- Dependiendo de su teléfono celular, es posible que le pida que introduzca el NIP de Bluetooth (predeterminado: "0000"). Si su teléfono celular muestra la confirmación de la PassKey en su pantalla, siga las instrucciones para continuar.
- 3 Unidad base:**
Espere a que se emita un pitido largo.
- Es posible que tarde más de 10 segundos en completar el emparejamiento.
 - Cuando el indicador de CELL correspondiente se ilumina, esto significa que el teléfono celular está conectado a la unidad base. Ya está listo para hacer llamadas regulares de celular.
- Nota:**
- Asegúrese de que su teléfono celular está configurado para conectarse a este producto automáticamente. Consulte las instrucciones de operación de su teléfono celular.

Unidad base: Indicadores de CELL

Estado	Significado
Encendido	Un teléfono celular está conectado. Listo para hacer o recibir llamadas celulares.
Parpadea lentamente	<ul style="list-style-type: none"> - La línea del celular se está usando. - Las entradas del directorio telefónico se están copiando desde un teléfono celular. - La unidad base está buscando el teléfono celular emparejado. - La unidad base está emparejando un teléfono celular. - Hay una llamada de celular en espera. - La función de asistencia de voz remota está en uso.
Parpadea rápidamente	Se está recibiendo una llamada de celular o un mensaje de texto.
Luz apagada	<ul style="list-style-type: none"> - No hay un teléfono celular emparejado con la unidad base. - No hay un teléfono celular conectado a la unidad base.

Auricular: enlace a elementos de la pantalla del celular

	<ul style="list-style-type: none"> - Se está usando una línea de celular.^{*1} • Cuando parpadea lentamente: La llamada celular está en espera. • Cuando parpadea rápidamente: se está recibiendo una llamada celular o un mensaje de texto. - La función de asistencia de voz remota está en uso.^{*1} <p>^{*1} Las líneas correspondientes (1, 2: línea del celular) se indican junto al elemento.</p>
	<ul style="list-style-type: none"> - Un teléfono celular está conectado.^{*1} Listo para hacer o recibir llamadas celulares. • Cuando está apagado: no hay un teléfono celular conectado a la unidad base. <p>^{*1} Las líneas correspondientes (1, 2: línea del celular) se indican junto al elemento.</p>

Guía Rápida Española

Enlace a celular



- Se está haciendo una llamada de celular en esa línea.
- La línea celular está seleccionada para la configuración.

Cómo conectar o desconectar el teléfono celular (Auricular)

Conexión automática a los dispositivos con Bluetooth (teléfonos celulares)

La unidad se conecta a los dispositivos Bluetooth a intervalos regulares si se pierde la conexión. Consulte las instrucciones de operación para cambiar el intervalo (predeterminado: "1 min").

- Solo 1 dispositivo Bluetooth puede usarse con la unidad a la vez, y la unidad base pierde su conexión con otros dispositivos Bluetooth. Para restablecer la conexión a los dispositivos Bluetooth automáticamente, deje encendida la conexión automática.

Cómo conectar o desconectar manualmente el teléfono celular

Si no va a utilizar el vínculo del teléfono celular emparejado a la función del celular temporalmente (por ejemplo, si no quiere que la unidad timbre cuando su línea celular reciba una llamada), puede desconectar su teléfono celular de la unidad base. Si desea usarlo de nuevo, reconecte el teléfono celular a la unidad base.

- Después de desconectar un teléfono celular emparejado de la unidad base manualmente, se conectará automáticamente a la misma en 30 minutos. Si ya no usa la función de enlace al celular, deshaga el emparejamiento del celular.
- Los teléfonos celulares desconectados no se desemparejan de la unidad base, así que no es necesario emparejarlos de nuevo con ella.

1 Para conectarlo o desconectarlo:

Para CELL 1: [MENU] [#] 6 [2] 5 [1]

Para CELL 2: [MENU] [#] 6 [2] 5 [2]

- Se emite un pitido largo.

2 [OFF]

Modo exclusivo para la línea celular (si no utiliza la línea terrestre) (Auricular)

Si no utiliza la línea terrestre, recomendamos configurar la unidad en el modo exclusivo para la línea celular. La configuración predeterminada es "Apagado".

- Si enciende el "Modo lín. Cel.", desconecte el cable de la línea telefónica de la unidad base. De lo contrario, no es posible activar el "Modo lín. Cel."

1 [MENU] [#] 1 [5] [7]

2 Para encenderlo:

[↕]: "Encendido" → [SELEC.] → [↕]: "Sí" → [SELEC.]

Para apagarlo:

[↕]: "Apagado" → [SELEC.]

Operaciones básicas

Cómo hacer y contestar llamadas (Auricular)

Para hacer llamadas de celular	<p>1 Marque el número telefónico. → [CEL.]</p> <ul style="list-style-type: none"> • Cuando el modo exclusivo para la línea celular está configurado, también puede oprimir [📶]/[📞] en lugar de [CEL.]. <p>2 Cuando solo hay 1 teléfono celular emparejado, la unidad comienza a marcar. Cuando hay 2 teléfonos celulares emparejados: [📶]: Seleccione el teléfono celular deseado. → [SELEC.]</p>
Para hacer llamadas por la línea terrestre	Marque el número telefónico. → [📶]/[📞]
Para contestar llamadas	[📶]/[📞]
Para colgar	[OFF]
Para ajustar el volumen del receptor o del altavoz	Oprima [▲] o [▼] repetidamente mientras habla.
Cómo hacer una llamada usando la lista de remarcación	<p>1 [▶] REDIAL → [📶]: Seleccione la entrada deseada.</p> <p>2 Para hacer una llamada celular: Cuando solo 1 teléfono celular está emparejado: [CEL.] o Cuando 2 teléfonos celulares están emparejados: [CEL.] → [📶]: Seleccione el teléfono celular deseado. → [SELEC.] Para hacer una llamada terrestre: [📶]/[📞]</p>
Para ajustar el volumen del timbre (línea de celular/línea terrestre)	Oprima [▲] o [▼] repetidamente para seleccionar el volumen deseado mientras timbra.

Guía Rápida Española

Operaciones básicas

Directorio telefónico (Auricular)

Para añadir entradas	<ol style="list-style-type: none"> 1 [←] □ □ → [MENU] 2 [+]: "Agregar ent. nueva" → [SELEC.] 3 Introduzca el nombre de la persona (máx. 16 caracteres). → [OK] 4 Introduzca el número telefónico de la persona (máx. 24 dígitos). → [OK] 5 [+]: Seleccione el grupo deseado. → [SELEC.] 2 veces → [OFF] <ul style="list-style-type: none"> • En el paso 3, puede cambiar el idioma de introducción de caracteres. [#] → [+]: Seleccione el idioma deseado. → [OK]
Para hacer llamadas	<ol style="list-style-type: none"> 1 [←] □ □ → [+]: Seleccione la entrada deseada. 2 Para hacer una llamada celular: Cuando solo 1 teléfono celular está emparejado: [CEL.] o Cuando 2 teléfonos celulares están emparejados: [CEL.] → [+]: Seleccione el teléfono celular deseado. → [SELEC.] Para hacer una llamada terrestre: [↶]
Sistema contestador de llamadas de la línea terrestre (Unidad base)	
Contestador encendido/apagado	Oprima [ANSWER ON/OFF] para encender y apagar el contestador de llamadas.
Para escuchar mensajes	[▶■] (PLAY)
Sistema contestador de llamadas de la línea terrestre (Auricular)	
Para escuchar mensajes	Para escuchar mensajes nuevos: [REPROD.] o [MENU] [#] [3] [2] [3] Para escuchar todos los mensajes: [MENU] [#] [3] [2] [4]

Cómo usar dispositivos Bluetooth**Copiado de entradas del directorio telefónico desde un teléfono celular con Bluetooth (transferencia del directorio telefónico)**

Puede copiar entradas del directorio telefónico desde los teléfonos celulares emparejados o desde otros teléfonos celulares (no emparejados) al directorio telefónico de la unidad.

1 Auricular: [MENU] [6] [1] [8]

2 Auricular:

Para copiar desde teléfonos celulares emparejados:

[+]: Seleccione el teléfono celular deseado. → [SELEC.]

- Los elementos copiados se almacenan en el grupo ("Ce1. 1" o "Ce1. 2") en el que está emparejado el teléfono celular.

Para copiar desde otros teléfonos celulares (no emparejados):

[+]: "Otro celular" → [SELEC.] → [+]: Seleccione el grupo al que desea copiar. → [SELEC.]

3 Auricular:

Cuando aparezca "Transf. datos del directorio del celular": Vaya al paso 4.

Cuando aparezca el menú "Selec. modo":

[+]: Seleccione "Auto" o "Manual". → [SELEC.]

"Auto": Descargue todas las entradas del teléfono celular automáticamente. Vaya al paso 5.

"Manual": Copie las entradas que seleccionó.

- El menú "Selec. modo" aparece solo cuando el teléfono celular soporta Perfil de Acceso a Directorio Telefónico (PBAP) para la conexión Bluetooth.
- Algunos teléfonos celulares quizás requieran que realice una operación en el mismo incluso si selecciona "Auto".

4 Teléfono celular:

Siga las instrucciones de su teléfono celular para copiar las entradas del directorio telefónico.

- Para otros teléfonos celulares (no emparejados), necesita buscar y seleccionar la unidad base. Quizás requiera el NIP de Bluetooth (predeterminado: "0000"). Si su teléfono celular muestra la confirmación de la PassKey en su pantalla, siga las instrucciones para continuar.
- Las entradas que se están copiando aparecen en el auricular.

5 Auricular:

Espere a que aparezca "Completo". → [OFF]

Cómo usar dispositivos Bluetooth

Cómo usar un audífono Bluetooth (opcional)

Al emparejar un audífono Bluetooth con la unidad base, podrá tener conversaciones a manos libres para llamadas terrestres.

- Solo se puede usar 1 dispositivo Bluetooth con la unidad al mismo tiempo.*1

*1 No es posible usar un audífono Bluetooth para hablar en una línea celular.

Cómo emparejar un audífono Bluetooth con la unidad base

1 Audífono Bluetooth:

Configure su audífono en modo de emparejamiento.

- Consulte las instrucciones de operación de su audífono.

2 Auricular:

[MENU] **[#]** **[6]** **[2]** **[1]**

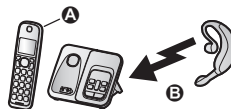

A Empareje usando el auricular.

B Emparejamiento

3 Si el NIP de su audífono es "0000", vaya al paso 4.

Si el PIN de su audífono no es "0000", oprima **[BORRAR]** y, a continuación, escriba el PIN de su audífono.

- Por lo general, el NIP predeterminado es "0000". Consulte las instrucciones de operación del audífono.

4 Oprima **[OK]**, y después espere a que se emita un pitido largo. → **[OFF]**

- Cuando el indicador HEADSET de la unidad base se ilumina, usted está listo para usar el audífono.

Cómo operar un audífono con Bluetooth usando una línea terrestre

- Para obtener detalles, consulte las instrucciones de operación de su audífono.

- Es posible que algunas funciones descritas aquí no estén disponibles según el auricular Bluetooth.

■ Cómo contestar llamadas de la línea terrestre con su audífono

Para contestar una llamada de línea terrestre, oprima el botón del audífono.

Cuando termine de hablar, oprima el botón del audífono.

- Si no puede colgar la llamada usando su audífono, oprima **[▶■]** (STOP) en la unidad base.

■ Cómo cambiar entre la unidad base y su audífono

Puede cambiar entre la unidad base y su audífono mientras escucha los mensajes grabados en el contestador de llamadas de la unidad base.

Para cambiar a su audífono:

Oprima el botón del audífono.

Preguntas frecuentes

Pregunta	Causa y solución
¿Por qué aparece Ψ ?	<ul style="list-style-type: none"> • El auricular está demasiado lejos de la unidad base. Acérquelo. • El adaptador para corriente de la unidad base no está conectado correctamente. Conecte de nuevo el adaptador para corriente a la unidad base. • El auricular no está registrado en la unidad base. Regístrelo. <ol style="list-style-type: none"> 1 Auricular: [MENU] [M] [1] [3] [0] 2 Unidad base: Oprima y mantenga oprimido [LOCATOR] durante aproximadamente 5 segundos. 3 Auricular: Oprima [OK], y después espere hasta que suene un pitido largo.
¿Por qué no es posible emparejar un teléfono celular con la unidad base?	<ul style="list-style-type: none"> • Dependiendo de la compatibilidad del teléfono celular, es posible que no pueda emparejarlo con la unidad base. Para obtener más información, visite: http://shop.panasonic.com/bluetooth-phone • Confirme que la función de Bluetooth de su teléfono celular esté encendida. Es posible que necesite encender esta función dependiendo de su teléfono celular.
¿Por qué no se escucha el tono de marcación? (línea celular)	<ul style="list-style-type: none"> • El teléfono celular no se ha emparejado con la unidad base. Empareje el teléfono celular.
¿Cómo se incrementa el nivel de volumen del auricular?	<ul style="list-style-type: none"> • Oprima la tecla de volumen [▲] repetidamente mientras habla.
¿Por qué hay ruido o se corta la conversación?	<ul style="list-style-type: none"> • Trate de reubicar la unidad base de forma que se minimice la distancia al auricular. • Si ocurre el mismo problema aunque el auricular se encuentre enseguida de la unidad base, visite: http://shop.panasonic.com/support
¿Es posible añadir otro auricular accesorio a mi unidad base?	<ul style="list-style-type: none"> • Sí, puede añadir hasta 6 auriculares (incluyendo los que se venden con su unidad base) a una sola unidad base. • Para adquirir auriculares accesorios adicionales (KX-TGDA83/ KX-TGDA86), visite: http://shop.panasonic.com/support Los usuarios TTY (usuarios con impedimentos auditivos o del habla) pueden llamar al 1-877-833-8855.
¿Es posible mantener cargando las baterías todo el tiempo?	<ul style="list-style-type: none"> • Puede dejar el auricular en la unidad base o el cargador en cualquier momento. Esto no daña las baterías.
¿Cómo se contestan las llamadas en espera (2a llamada)?	<ul style="list-style-type: none"> • Oprima [FLASH] cuando escuche el tono de llamada en espera.

Customer services

Shop
Accessories!

for all your Panasonic gear

Go to

<http://shop.panasonic.com/support>

Get everything you need to get the most out of
your Panasonic products
Accessories & Parts for your Camera, Phone, A/V
products, TV, Computers & Networking, Personal
Care, Home Appliances, Headphones, Batteries,
Backup Chargers & more...

Customer Services Directory

For Product Information, Operating Assistance,
Parts, Owner's Manuals, Dealer and Service info
go to <http://shop.panasonic.com/support>

For the hearing or speech impaired TTY: 1- 877-833-8855

As of June 2015

Limited Warranty (ONLY FOR U.S.A.)

Panasonic Products Limited Warranty

Limited Warranty Coverage (For USA Only)

If your product does not work properly because of a defect in materials or workmanship, Panasonic Corporation of North America (referred to as “the warrantor”) will, for the length of the period indicated on the chart below, which starts with the date of original purchase (“warranty period”), at its option either (a) repair your product with new or refurbished parts, (b) replace it with a new or a refurbished equivalent value product, or (c) refund your purchase price. The decision to repair, replace or refund will be made by the warrantor.

Product or Part Name	Parts	Labor
Telephone	One (1) Year	One (1) Year

During the “Labor” warranty period there will be no charge for labor. During the “Parts” warranty period, there will be no charge for parts. This Limited Warranty excludes both parts and labor for non-rechargeable batteries, antennas, and cosmetic parts (cabinet). This warranty only applies to products purchased and serviced in the United States. This warranty is extended only to the original purchaser of a new product which was not sold “as is”.

Mail-In Service--Online Repair Request

Online Repair Request

To submit a new repair request and for quick repair status visit our Web Site at <http://shop.panasonic.com/support>

When shipping the unit, carefully pack, include all supplied accessories listed in the Owner’s Manual, and send it prepaid, adequately insured and packed well in a carton box. When shipping Lithium Ion batteries please visit our Web Site at <http://shop.panasonic.com/support> as Panasonic is committed to providing the most up to date information. Include a letter detailing the complaint, a return address and provide a daytime phone number where you can be reached. A valid registered receipt is required under the Limited Warranty.

IF REPAIR IS NEEDED DURING THE WARRANTY PERIOD, THE PURCHASER WILL BE REQUIRED TO FURNISH A SALES RECEIPT/PROOF OF PURCHASE INDICATING DATE OF PURCHASE, AMOUNT PAID AND PLACE OF PURCHASE. CUSTOMER WILL BE CHARGED FOR THE REPAIR OF ANY UNIT RECEIVED WITHOUT SUCH PROOF OF PURCHASE.

Appendix

Limited Warranty Limits and Exclusions

This warranty ONLY COVERS failures due to defects in materials or workmanship, and DOES NOT COVER normal wear and tear or cosmetic damage. The warranty ALSO DOES NOT COVER damages which occurred in shipment, or failures which are caused by products not supplied by the warrantor, or failures which result from accidents, misuse, abuse, neglect, mishandling, misapplication, alteration, faulty installation, set-up adjustments, misadjustment of consumer controls, improper maintenance, power line surge, lightning damage, modification, introduction of sand, humidity or liquids, commercial use such as hotel, office, restaurant, or other business or rental use of the product, or service by anyone other than a Factory Service Center or other Authorized Servicer, or damage that is attributable to acts of God.

THERE ARE NO EXPRESS WARRANTIES EXCEPT AS LISTED UNDER "LIMITED WARRANTY COVERAGE".

THE WARRANTOR IS NOT LIABLE FOR INCIDENTAL OR CONSEQUENTIAL DAMAGES RESULTING FROM THE USE OF THIS PRODUCT, OR ARISING OUT OF ANY BREACH OF THIS WARRANTY.

(As examples, this excludes damages for lost time, travel to and from the servicer, loss of or damage to media or images, data or other memory or recorded content. The items listed are not exclusive, but for illustration only.)

ALL EXPRESS AND IMPLIED WARRANTIES, INCLUDING THE WARRANTY OF MERCHANTABILITY, ARE LIMITED TO THE PERIOD OF THE LIMITED WARRANTY.

Some states do not allow the exclusion or limitation of incidental or consequential damages, or limitations on how long an implied warranty lasts, so the exclusions may not apply to you. This warranty gives you specific legal rights and you may also have other rights which vary from state to state. If a problem with this product develops during or after the warranty period, you may contact your dealer or Service Center. If the problem is not handled to your satisfaction, then write to:

Panasonic Corporation of North America
Consumer Affairs Department 8th Fl.
Two Riverfront Plaza
Newark NJ 07102-5490

PARTS AND SERVICE, WHICH ARE NOT COVERED BY THIS LIMITED WARRANTY, ARE YOUR RESPONSIBILITY.

As of January 2020

Index

- # 3-way conference: 25
- A** Additional handset: 51
 - Alarm: 48
 - Answer by voice command: 28
 - Answering calls: 23
 - Answering system
 - Call screening: 67
 - Erasing messages: 63, 64, 66
 - Greeting message: 62
 - Greeting only: 67
 - Listening to messages: 63, 66
 - New message alerting: 64
 - Number of rings: 67
 - Recording time: 67
 - Remote access code: 66
 - Remote operation: 66
 - Ring count: 67
 - Toll saver: 67
 - Turning on/off: 62
 - Assist button: 14
 - Auto intercom: 27
 - Auto talk: 23, 46
 - Automated call block: 32
- B** Baby monitor: 49
 - Battery: 11, 12
 - Bluetooth wireless technology
 - Cellular phone (Link to cell): 18
 - Headset: 59
 - Phonebook transfer: 56
- C** Call block: 29
 - One ring for blocked call: 30
- Call share: 25, 46
- Call waiting: 24
- Call Waiting Caller ID: 24
- Caller ID number auto edit: 46, 54
- Caller ID service: 53
- Caller list: 53
- Caller list edit: 54
- Cellular calls: 22
- Cellular phone
 - Pairing: 18
 - Unpairing: 18
- Chain dial: 38
- CID (Caller ID): 53, 54
- Conference calls: 25
- Control type: 14
- Customer support: 47
- D** Date and time: 16
- Dialing mode: 16
- Direct command code: 40
- Display
 - Contrast: 46
 - Language: 16
- E** Eco mode: 13
 - Equalizer: 24
 - Error messages: 72
- F** Flash: 24, 46
- G** Groups: 37
- H** Handset
 - Deregistration: 52
 - Name: 51
 - Registration: 51
- Hold: 23
- I** Intercom: 26
- K** Key detector: 45, 47
 - Key tone: 46
- L** Landline calls: 22
 - Line mode: 46
- Link to cell
 - Alert settings for your DECT phone: 58
 - Area code: 21
 - Auto connection: 19
 - Cellular line only mode: 20
 - Cellular line selection: 21
 - Connection: 20
 - Link to Cell app: 57
 - Ring as cell mode: 19
 - Select unit to ring: 19
 - Text message (SMS: Short Message Service) alert: 58
- Low battery alert: 17
- M** Making calls: 22
 - Missed calls: 53
 - Mute: 24
- N** Noise reduction: 24
- O** One ring scam alert: 34
- P** Pause: 23
 - Phonebook: 36
 - PIN: 21
 - Power failure: 12
- R** Recording telephone conversations: 25
 - Redialing: 22, 23
 - Remote voice assist: 58
 - Ringer ID: 37
 - Ringer tone: 42, 44
 - Rotary/pulse service: 24
- S** Silent mode: 49

Index

- Speed dial: 38
- SP-PHONE (Speakerphone): 22
- T** Talking Caller ID: 53
- Telemarketing call block: 34
- Temporary tone dialing: 24
- Time adjustment: 44
- Transferring calls: 25
- Troubleshooting: 73
- TTY: 96
- V** VM (Voicemail): 68
- Voice announcement language: 16
- Voice paging: 27
- Voicemail: 68
- Volume
 - Receiver: 22
 - Ringer (Base unit): 23, 42, 44
 - Ringer (Handset): 23, 42, 44
 - Ringer for intercom call (Handset): 44
 - Speaker: 22
- W** Wall mounting: 69

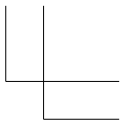
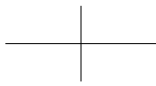
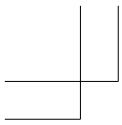

Notes

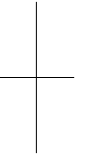
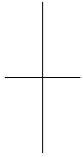

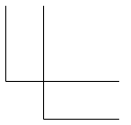
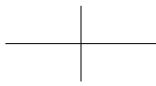
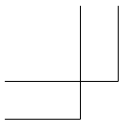

Notes

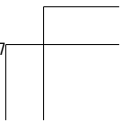
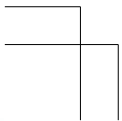
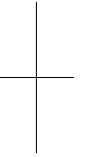
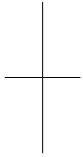

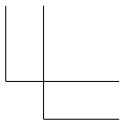
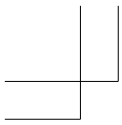

Notes

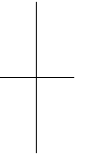
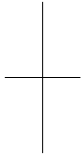

IMPORTANT!

If your product is not working properly. . .

- ① **Reconnect AC adaptor to the base unit.**
- ② **Check if telephone line cord is connected.**
- ③ **Use rechargeable Ni-MH batteries.**
(Alkaline/Manganese/Ni-Cd batteries CANNOT be used.)
- ④ Read **troubleshooting** page in the **Operating Instructions**.



Visit our Web site: <http://shop.panasonic.com/support>

- **FAQ and troubleshooting hints are available.**

For your future reference

We recommend keeping a record of the following information to assist with any repair under warranty.

Serial No.	Date of purchase
(found on the bottom of the base unit)	
Name and address of dealer	
Attach your purchase receipt here.	

Panasonic Corporation of North America

Two Riverfront Plaza, Newark, NJ 07102-5490

© Panasonic Corporation 2020

Printed in Malaysia



PNQX9141ZA

PNQX9141ZA PP1220LC0