

**Veise**

# *Installation Manual*

Model No. VE001



**Tutorial Video**

Scan the QR code and search **VE001** to get the video.

## **Need Help? Contact Us!**

Call us at **+1(855)400-3853** ( Monday-Friday 9:00am-5:00pm PST ), if you have any questions.

✉ [support@iveise.com](mailto:support@iveise.com) 🌐 [iveise.com](http://iveise.com)

## » Content





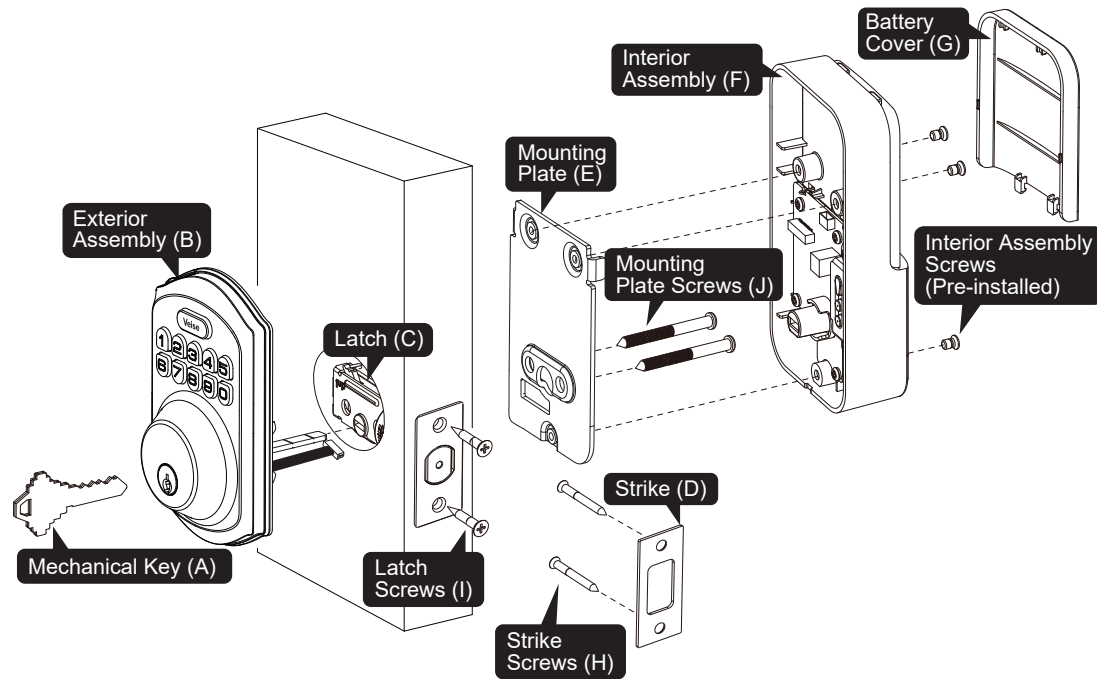



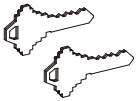

• Parts List	02
• Installation Guide	03
Step 1: Prepare the Door & Check Dimensions	04
Step 2: Install the Latch & Strike	06
Step 3: Install Exterior Assembly	09
Step 4: Install Interior Assembly	10
Step 5: Distinguish Left / Right Hand Door	12
• How to Reset	13
• Troubleshooting	14

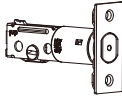
## » Installation Overview

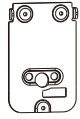
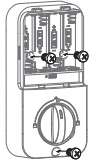

01

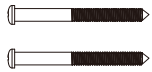
## Parts List

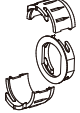
<p><b>A</b> Mechanical Keys <b>x2</b></p> 	<p><b>B</b> Exterior Assembly <b>x1</b></p> 	<p><b>C</b> Latch <b>x1</b></p> 	<p><b>D</b> Strike <b>x1</b></p> 
<p><b>E</b> Mounting Plate <b>x1</b></p> 	<p><b>F</b> Interior Assembly <b>x1</b> (3 Screws Pre-installed)</p> 	<p><b>G</b> Battery Cover <b>x1</b></p> 	<p><b>H</b> Strike Screws <b>x2</b></p>  <p><b>I</b> Latch Screws <b>x2</b></p> 
<p><b>J</b> Mounting Plate Screws <b>x2</b></p> 	<p><b>K</b> Interior Assembly Screws (Spare) <b>x2</b></p> 	<p><b>L</b> Reset Tool <b>x1</b></p> 	<p><b>M</b> Drive-In Collar (Optional)</p> 

⚠ Missing any parts? Call us at [+1\(855\)400-3853](tel:+18554003853). ✉ [support@iveise.com](mailto:support@iveise.com) 02



## Installation Guide

### ▶ Step 1: Prepare the Door & Check Dimensions

**1**

The hole in the door is 2-1/8" (54mm).

The hole in the door edge is 1" (25mm).

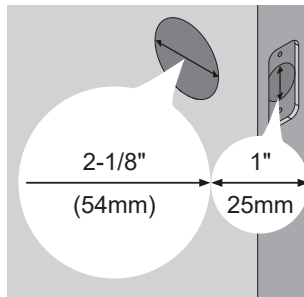

**2**

The backset is either 2-3/8" or 2-3/4" (60mm or 70mm).

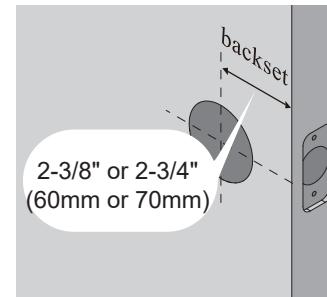

**3**

The door thickness is 1-3/8" to 2" (35mm to 50mm).

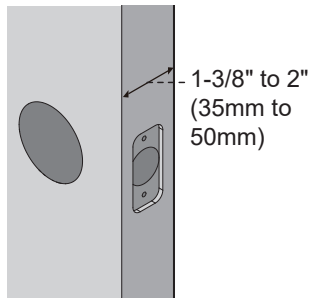

**4**

**NOTE:** Make sure the door frame is aligned with the door.

There are no obstructions stuck in the door frame.

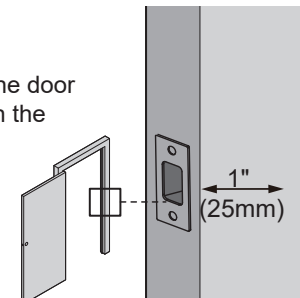



## Installation Guide

### ▶ Step 1: Prepare the Door & Check Dimensions

#### Optional: Instructions for doors with 1-1/2" (38mm) holes

##### 1. Test whether you need to extend the Latch hole.

Temporarily install the Latch bolt.

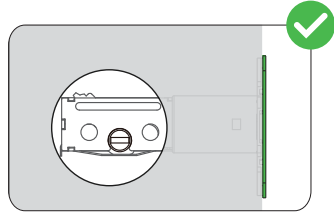

Fit properly

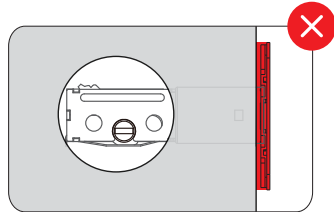

Fit improperly

If the Latch bolt is stuck, you need to extend the Latch hole.

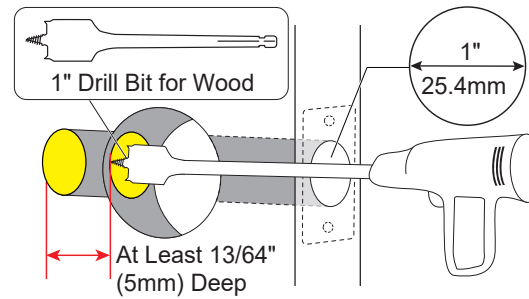

Extend the Latch hole at least 13/64" (5mm) deep by using a 1" (25.4mm) Drill Bit.



## Installation Guide

### ▶ Step 1: Prepare the Door & Check Dimensions

#### 2. Test the extended Latch hole.

Temporarily install the Latch bolt, rotate it with a screwdriver to test if it extends and retracts properly.

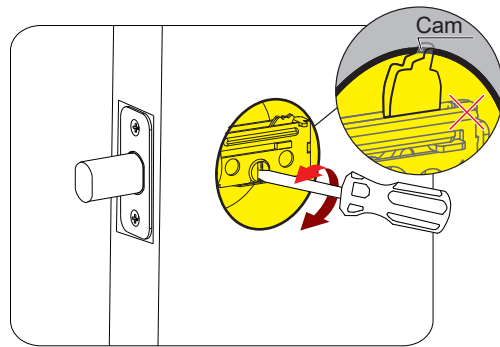

05

If the Latch bolt is stuck, remove the Latch bolt and chisel out a small channel at the top of the hole to give the Cam room to rotate.

(Refer to the following image)

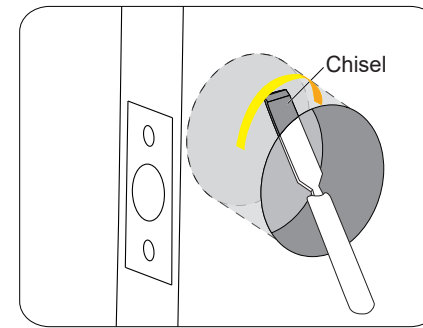



## Installation Guide

### ▶ Step 2: Install the Latch & Strike

**1** Confirm the backset and adjust the Latch.

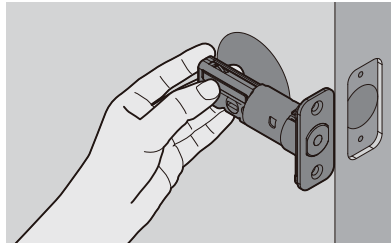

Hold the Latch in front of the door hole, flush the Latch against the door edge.  
Is the slotted hole centred in the door hole?

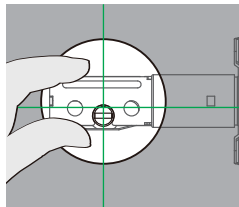

**YES**

No need to adjust.

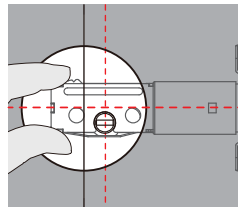

**NO** →

Slotted hole is NOT centred.

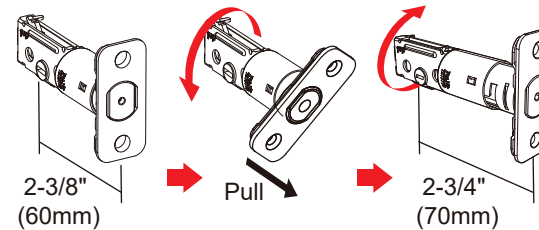

2-3/8"  
(60mm)

→ Pull →

2-3/4"  
(70mm)

Rotate and pull the Latch as shown to extend the Latch.



## Installation Guide

### ▶ Step 2: Install the Latch & Strike

**2** Install the Latch.

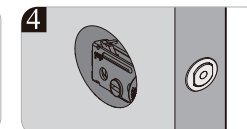
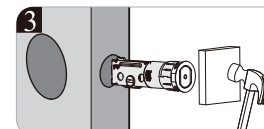
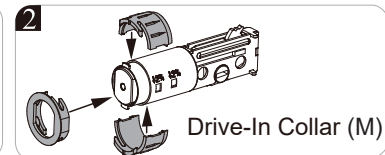
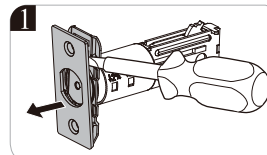
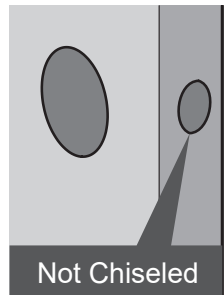
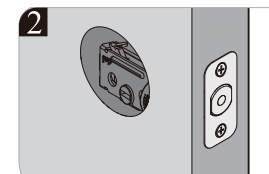
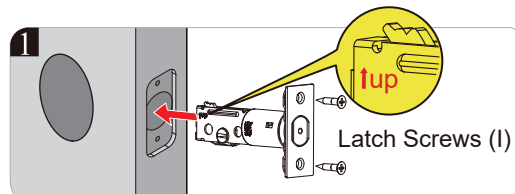



## Installation Guide

### ▶ Step 2: Install the Latch & Strike

- 3** Test if the Latch bolt extends and retracts properly by using a screwdriver.

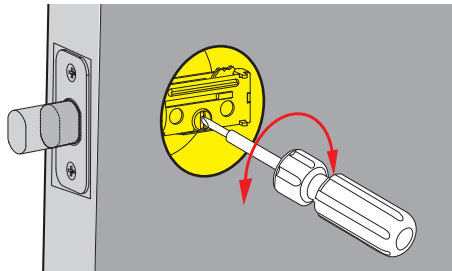

**⚠ Important:**

Before installation, the Latch bolt should be retracted completely (in the unlocked position).

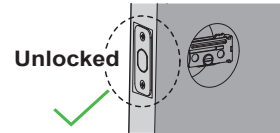

- 4** Install Strike on the door frame.

**⚠ Important:**

Make sure the hole in door frame is drilled a minimum of 1" (25mm) deep.

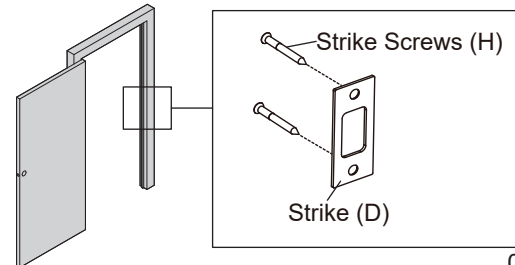



## Installation Guide

### ▶ Step 3: Install Exterior Assembly

- 1** Route the cable below the Latch and insert the Torque Blade horizontally into the Latch slot, ensuring both the blade and slot are level.

Do not insert the Mechanical Key into the cylinder during the installation.

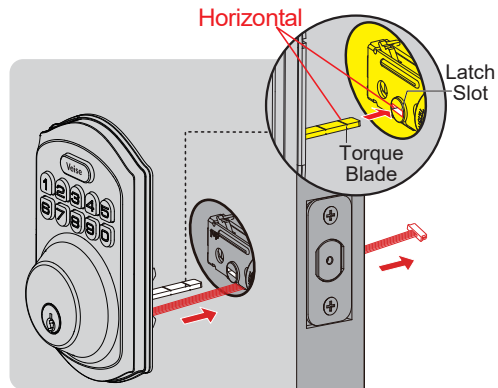

09

- 2** Install the Mounting Plate with the Mounting Plate Screws.

Do not overtighten screws.

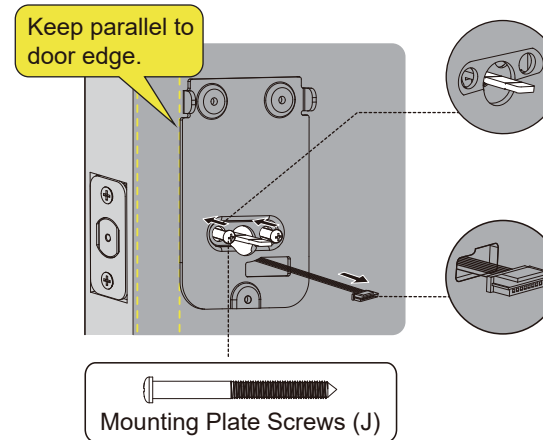



## Installation Guide

### ▶ Step 4: Install Interior Assembly

- 1** Disassemble the Battery Cover.

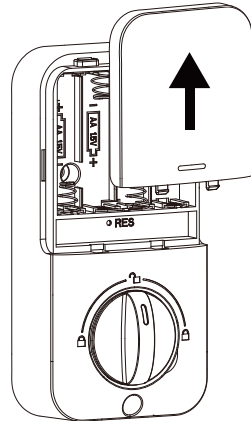

**⚠ Important:**  
Do not load batteries until lock is completely installed.

- 2** Insert the cable connector into the socket.  
Push the connector in firmly until it is completely attached.

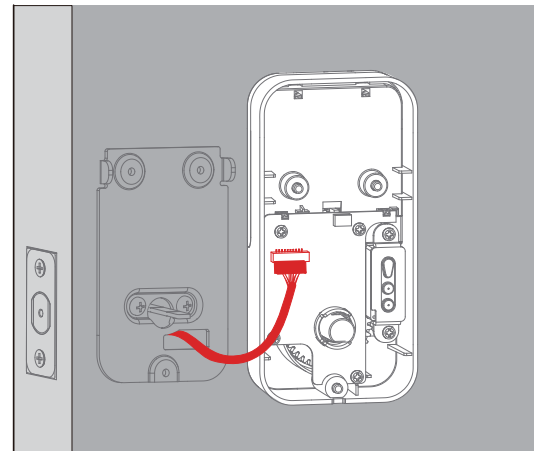



## Installation Guide

### ▶ Step 4: Install Interior Assembly

- 3** Keep the Thumb Turn in Vertical position and Torque Blade in Horizontal position, then install the Interior Assembly.

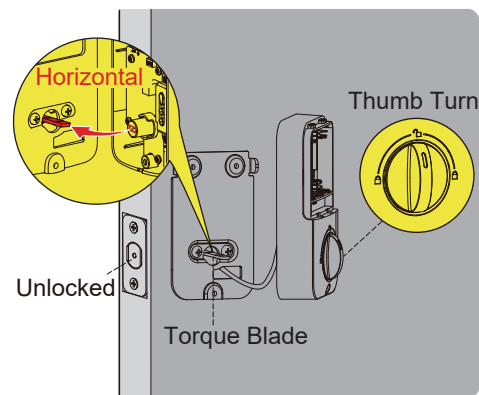

- 4** Attach Interior Assembly to the Mounting Plate and tighten 3 screws.

**NOTE:**

Three screws are pre-installed on the Interior Assembly for your convenience. The two (K) in the accessory pack are spares.

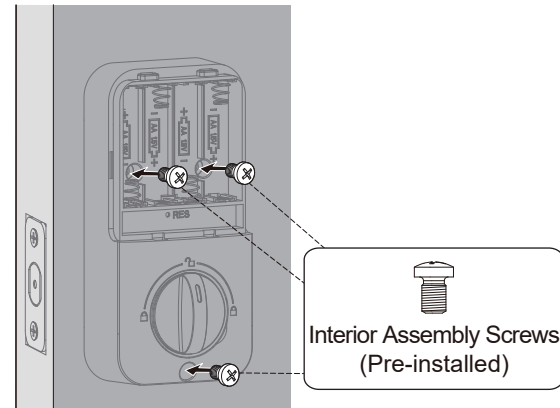



## Installation Guide

### ▶ Step 5: Distinguish Left / Right Hand Door

**⚠ Important:** This step is required and crucial for the lock to operate properly.

- 1** Keep the door **open and unlocked**, load 3 AA batteries into the battery compartment.

**Note:** Please use all new, non-rechargeable Alkaline batteries only.

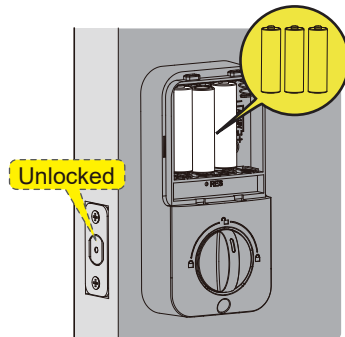

- 2** Press and hold the Reset Button on the Interior Assembly by using the Reset Tool.

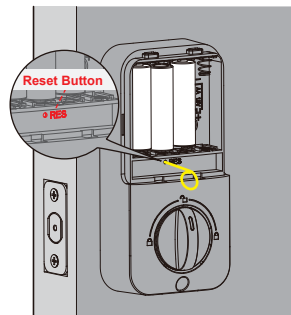

- 3** Continue holding the Reset Button while loading the last battery until you hear a long beep. The Latch bolt will extend automatically and memorize the door's opening direction.

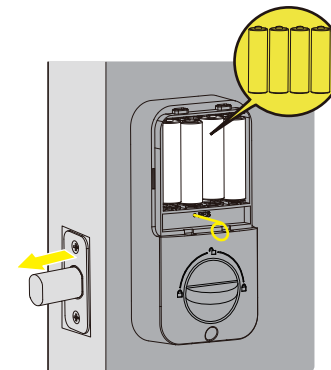

## How to Reset

- 1** Keep the door open and unlocked.
- 2** Remove one battery, press and hold the Reset Button for 5 seconds by using the Reset Tool.
- 3** Keep holding the Reset Button and put the battery back, until you hear a long sound of beep and the Latch bolt extends out automatically.

Settings	Factory Default
Master Code	12345678
Auto Lock	Disabled
Silent Mode	Disabled
Wrong Entry Limit	10 times
Shutdown Time	3 mins
Vacation Mode	Disabled



Scan the QR code  
Search **VE001**

Call us at **+1(855)400-3853**,  
if you have any questions.

 [support@iveise.com](mailto:support@iveise.com)  [iveise.com](http://iveise.com)

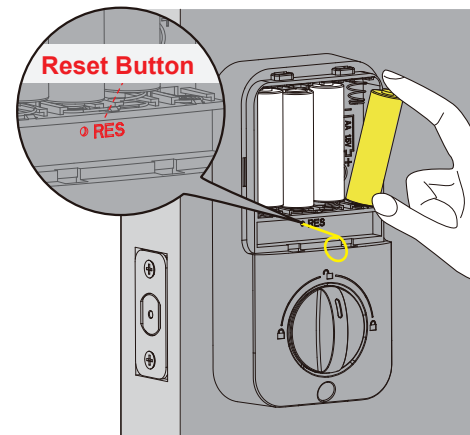



## Troubleshooting

### ▶ The Latch bolt keeps going in and out.

Disassemble and reinstall the lock by following the installation tips.

1. Please don't insert the Mechanical Key into lock cylinder before or during installation.
2. Keep the Latch fully retracted and the Torque Blade horizontal.
3. Please make sure to route the cable below the Latch.
4. The Exterior and Interior Assembly should be installed parallel to the door edge.
5. Please reset the lock before programming.

### ▶ I cannot remove my key unless it is in the locked position.

Uninstall the Interior and Exterior Assemblies. Before re-installation, please follow these guidelines:

1. Make sure the Latch bolt is in the retracted position.
2. Do not insert the Mechanical Key into lock cylinder before or during installation.
3. Make sure the Torque Blade is inserted horizontally.

### ▶ Fail to reset.

1. The battery is low if the battery indicator light keeps flashing. Please replace with 4 new batteries.  
(Alkaline batteries only)
2. Please refer to “**How to Reset**” section and perform a resetting again.



## Troubleshooting

### ► Unable to unlock / lock by Keypad.

1. Make sure you have entered the correct User Code.
2. Check the Strike to make sure it is properly aligned and clear so the Latch bolt can freely move in the hole.
3. Check the cable for any damage that may have occurred during installation. Make sure the cable is firmly connected.
4. The battery is low if the battery indicator light keeps flashing. Please replace with 4 new batteries and make sure the batteries are properly installed (Alkaline batteries only).

### ► The Latch bolt won't be extended out completely after installation.

Please review if the Exterior Assembly is aligned with the door parallel. The Exterior Assembly should not be at a crooked angle.

If you have any questions, please contact us at **+1(855)400-3853**.

✉ **support@iveise.com**

## » Information & Safety Warnings

- Protect your User Codes and Master Code.
- Restrict access to your lock's Interior Assembly and routinely check your settings to ensure they have not been altered without your knowledge.
- Do not use an electric screwdriver during installation.
- This manufacturer advises that no lock can provide complete security by itself.
- This lock may be defeated by forcible or technical means, or evaded by entry elsewhere on the property.
- No lock can substitute for caution, awareness of your environment, and common sense.
- Take care to ensure a long-lasting finish. Please use a soft and damp cloth to clean the lockset if you need. Using lacquer thinner, caustic soaps, abrasive cleaners or polishes could damage the coating and result in tarnishing.
- The lock is water-resistant. It can withstand water splashes; however, do not let water and liquids get into the lock.
- Avoid exposure to direct sunlight. Long-term exposure to direct sunlight may damage the lock.

# Need Help? Contact Us!

If you have any questions, please contact us at

 **+1(855)400-3853**

(Monday-Friday 9:00am-5:00pm PST)

 **support@iveise.com**  **iveise.com**

If you have your **order ID, videos or images of your problem** (if necessary) ready before contacting Customer Support, we will solve your problem faster and better.

V1.0