

# 45



**FORNO A VAPORE**

**ELECTRONIC OVENS**

**FOUR A VAPEUR**

**DAMPFGARER**

**HORNO DE VAPOR**

**STOOMOVEN**

**FORNO A VAPOR**

**IT** **INSTALLAZIONE - UTILIZZO - MANUTENZIONE**

**EN** **INSTALLATION - USE - MAINTENANCE**

**FR** **INSTALLATION - UTILISATION - MAINTENANCE**

**DE** **EINBAU - BENUTZUNG - WARTUNG**

**ES** **INSTALACIÓN - USO - MANTENIMIENTO**

**NL** **INSTALLATIE - GEBRUIK - ONDERHOUD**

**PT** **INSTALAÇÃO - UTILIZAÇÃO - MANUTENÇÃO**

TABLE OF CONTENTS	PAGE
<b>1 - Care And Maintenance</b>	<b>3</b>
<b>2- First Use</b>	<b>4</b>
Using the flat grill	4
Using the perforated tray	4
<b>3- Respect for the Environment</b>	<b>5</b>
<b>4- The Control Panel</b>	<b>6</b>
Keypad	6
<b>5- General Oven Information</b>	<b>7</b>
Error codes	7
Beeps	7
Default Settings	7
F Failure Number Codes	7
Preheat	7
Timer	7
<b>6- General Oven Tips</b>	<b>8</b>
Preheating the Oven	8
Operational Suggestions	8
High Altitude Baking	8
<b>7- Getting Started</b>	<b>9</b>
Instructions for initial switch-on	9
<b>8- User Settings</b>	<b>10</b>
Language	10
Temperature & Weight	10
Time	10
Date	11
Brightness	11
Volume	11
<b>9- System Setting</b>	<b>12</b>
Event Log	12
Demo	12
<b>10- Starting Your Oven</b>	<b>13</b>
Switching the oven on and off	13
Selecting the cooking mode	13
Cooking Mode Tables	14

TABLE OF CONTENTS	PAGE
<b>11 - Traditional Cooking</b>	<b>15</b>
Changing the cooking mode	15
Changing temperature	15
Pre-heating phase	15
<b>12 - Steam Cooking</b>	<b>16</b>
Steam operation	16
Steam Cooking	16
Combined Steam and Convection Cooking	17
Steam Assist Function	17
<b>13 - Using Oven Lights</b>	<b>18</b>
<b>14- Time Oven Mode Operation</b>	<b>19</b>
Cook Time	19
Stop Time	19
<b>15 - Setting the Meat Probe (if present)</b>	<b>20</b>
How use the food probe	21
<b>16 - Recipes</b>	<b>22</b>
<b>17 - Oven Care and Cleaning</b>	<b>24</b>
Oven Clean	24
Circuit Clean	24
Circuit Discharge	24
<b>18 - Replacing the oven Lamp</b>	<b>25</b>
<b>19 - For the Installer</b>	<b>26</b>
Installing the oven in a cabinet	26
Electrical Hook-Up	27
<b>20 - Solving Traditional Baking Problems</b>	<b>28</b>
<b>21 - Solving Operational Problems</b>	<b>29</b>
<b>22 - Assistance or Service</b>	<b>30</b>
Service Data Record	30



# IMPORTANT INSTRUCTIONS AND SAFETY WARNINGS



Read carefully and keep for future use

Dear Customer,

We would like to thank you and congratulate you on your choice.

This new product has been carefully designed and built using top quality materials, and meticulously tested to ensure that it meets all your culinary requirements.

Please read and observe these simple instructions, which will enable you to achieve excellent results from the very first time you use it. This state-of-the-art appliance comes to you with our very best wishes.

**THIS PRODUCT IS DESIGNED FOR DOMESTIC USE.**

**THE MANUFACTURER DECLINES ALL RESPONSIBILITY FOR PERSONAL INJURY OR PROPERTY DAMAGE DERIVING FROM INCORRECT INSTALLATION OR IMPROPER, ERRONEOUS OR UNSUITABLE USE.**

**THE APPLIANCE MUST NOT BE USED BY PEOPLE (INCLUDING CHILDREN) WITH PHYSICAL, SENSORIAL OR MENTAL IMPAIRMENTS, OR BY PEOPLE WITHOUT THE NECESSARY EXPERIENCE OR KNOWLEDGE, UNLESS THEY ARE SUPERVISED OR INSTRUCTED IN THE USE OF THE APPLIANCE BY A PERSON RESPONSIBLE FOR THEIR SAFETY.**

**CHILDREN MUST BE SUPERVISED TO ENSURE THAT THEY DO NOT PLAY WITH THE APPLIANCE.**

**DO NOT PLACE ALUMINIUM FOIL, POTS OR SIMILAR OBJECTS IN CONTACT WITH THE BASE INSIDE THE OVEN FOR COOKING.**

**THE APPLIANCE GETS VERY HOT DURING USE.**

**WARNING: DON'T TOUCH THE HEATING ELEMENTS INSIDE THE OVEN.**



## ATTENTION:

- If the door or the gasket seals of the door are damaged, the oven may not be used until it is repaired by a qualified service technician;
- This appliance and its internal components, especially electrified parts, may only be repaired, modified or customized by the manufacturer, its service department or similarly qualified persons. Incompetent repairs can cause serious accidents, damage to the appliance and its surroundings and malfunctions.
- Remember that even the replacement of the lamp inside the oven must be performed by qualified personnel who will first disconnect the appliance from the mains.
- If the appliance fails to operate or requires repair, contact our service department.
- Use only original replacement part.



## IMPORTANT:

- As a safety precaution, before cleaning the oven, always disconnect the plug from the outlet or remove the appliance's power cord.
- In addition, avoid using acid or alkaline substances (such as lemon, vinegar, salt, tomatoes, etc.). Avoid using products containing chlorine, acids or abrasives, especially for cleaning painted parts.

- Although the cooking chamber is made of high-quality steel, incorrect maintenance can cause corrosion;
- The oven must be cleaned periodically and all food residues must be removed;
- Do not clean the oven immediately after the dish has been removed because the residual drops of steam are still very hot (danger of burns); check that the display shows a low residual temperature or none.
- Take care when opening the door when the oven is on because the exiting steam can cause burns.
- If the electricity is interrupted, when it comes back on, the oven requires you to empty the circuit even though there shouldn't be any water in it.
- Do not use rough abrasives or sharp metal scrapers to clean the glass door of the oven because they could scratch the surface and cause the glass to shatter.
- During cleaning, take care that no water enters the appliance.
- Use only slightly damp rags.
- Never spray water inside or outside of the appliance.
- Do not use steam devices for cleaning because water that penetrates could cause damage.
- Do not use the appliance for heating or humidifying the room.
- Make use of the "child lock" key.
- The appliance must be installed and used in an ambient temperature between 5 °C and 35 °C.
- If there is a risk of frost, the residual water in the pumps could freeze and damage them.
- Use only the thermal probe recommended for this oven.
- The food probe is an accessory available only in some versions of the product
- The set of 6 Gastronorm trays is an accessory available on request



## IMPORTANT

The oven's identification plate is even accessible when the appliance is installed. This identification plate, which is visible when you open the door, shows all the information you will need when requesting replacement parts for the appliance.

### SERIAL TAG LOCATION

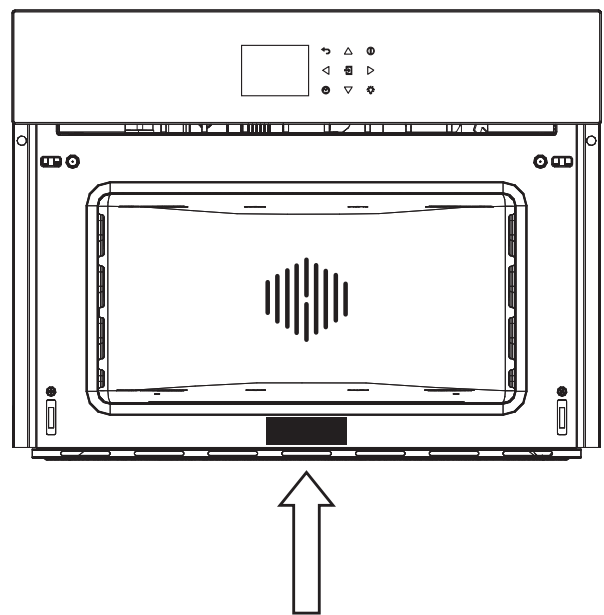

The oven should be thoroughly cleaned with soap and water and carefully rinsed. Heat the oven for about 30 minutes at the maximum temperature; this eliminates all the residual manufacturing oils that could cause unpleasant odours during cooking. Use the circular plus fan function without accessories in the oven. Before using the accessories for the first time, clean them carefully with a very hot alkaline washing solution and a soft cloth.

### Using the flat grill

To remove the flat grill, pull the grill towards you until it stops and then lift, by pulling upwards, until it comes completely out. To insert the flat grill, slide it in at an angle of 45° until it locks and then lower it horizontally and push it all the way in.



If the flat grill has a low drip tray, to remove it lift it slightly and slide it towards you. To reinsert it, slide it back until it is correctly seated.

### Using the perforated tray

This tray is used for steam cooking and is positioned on the flat grill together with its support.



**NOTE:** the set of 6 Gastronorm trays is an accessory available on request.

We recommend also using it in combination with the drip tray to catch everything the drips from the food during cooking.

The documentation for this appliance is printed on paper bleached without chlorine or recycled paper to contribute to protecting the environment.

The packaging was designed to prevent damage to the environment; they are ecological products that can be recovered or recycled.

Recycling the packing saves raw materials and reduces the volume of industrial and domestic waste.

THE PACKING MATERIAL is 100% recyclable and marked with the recycling symbol.

Dispose of in conformity with local law. The packing material (plastic bags, polystyrene parts, etc.) must be kept out of the reach of children because it is potentially dangerous.

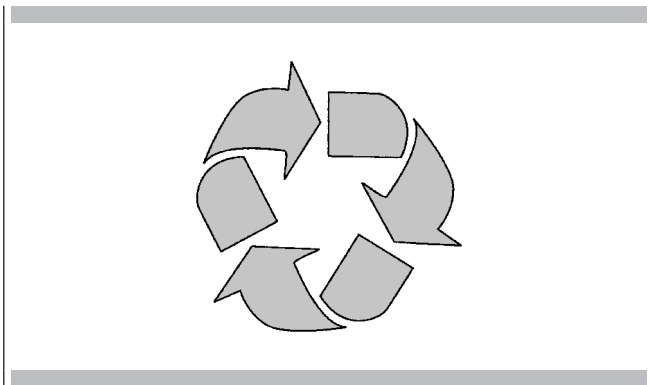

THIS APPLIANCE is marked in conformity with European Directive 2002/96/EC, Waste Electrical and Electronic Equipment (WEEE). By making sure that this product is disposed of correctly, the user contributes to preventing potential negative consequences for the environment and health.

THE SYMBOL on the product or accompanying documentation indicates that this product must not be treated as domestic waste but must be delivered to a suitable collection point for the recycling of electrical and electronic equipment.

DISPOSAL MUST BE MADE in conformity with local laws on waste disposal.

FOR ADDITIONAL INFORMATION about the treatment, recovery and recycling of this product, contact the local office of competence, the domestic waste collection service or the store where the product was purchased.

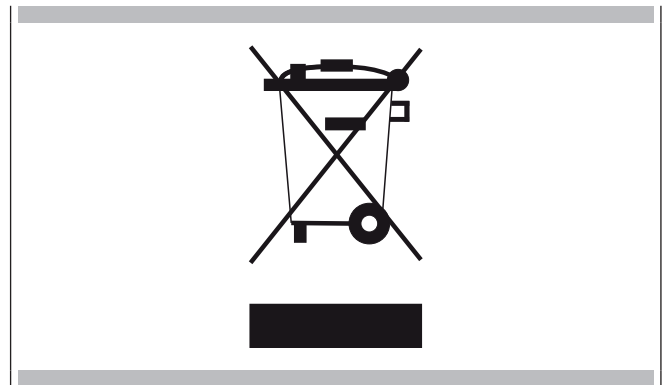

BEFORE SCRAPPING, make it unusable by cutting the electrical cord.

Your appliance could vary slightly compared to the illustrations below.







**A** - Keypad

**B** - Display screen



### Keypad

To operate the key, press gently. The keypad will not work if more than one key is pressed at the same time.

	Movement arrows
	Return to previous display page. Keep pressed to return to Home page
	Switches the oven on and off.
	Confirms the settings and starts cooking operations. When pressed during a cooking operation, the function is placed in pause. Press again to restart.
	To set the timer. Enter the functions menu during cooking.
	Switches the inner oven light on and off.

Before using your oven for the first time remove all packing and foreign materials from the oven(s). Any material of this sort left inside may melt or burn when the appliance is used.

## Error codes

This code appears in the event of the electronic control indicating a fault. When the error appears, the current function is blocked. If the type of error is related to a safety function, the oven becomes unusable and every time a start attempt is made, the same error appears (in which case call in the after-sales service), while if the error relates to a minor fault, after being restarted the oven can be used for the functions that do not involve the faulty part (e.g., a heating element).

## Beeps

Confirms that the command has been received after a key has been pressed.

It also indicates that a time function has been completed (e.g. Timer or Timed Cooking). During the execution of a recipe, an acoustic signal warns the user that the oven is waiting for operation by the user (e.g., insert the dish or turn it over). Beeps also signal an oven fault.

## Default Settings

The cooking modes automatically select a suitable temperature when the cooking mode is selected, these can be changed when a different one is needed.

## F Failure Number Codes

These codes are displayed when the electronic control detects a problem in the oven or in the electronics.

The error code is recorded in the Error Log in the Setup menu. This error can be communicated to the service technician so he/she can understand the possible cause of the problem in advance.

## Preheat

Whenever a cooking mode is set and the oven is heating, the preheating starts, during this period, the instantaneous temperature is displayed together with the thermometer icon. As soon as the 100% is reached, the control sounds an "end of preheat" tone and the current temperature value disappears.

## Timer



### WARNING

The timer on your oven does not turn the appliance on or off, its only purpose is to alert you through the buzzer. When you want to turn off the oven automatically, use the end-of-cooking or delayed cooking function.

**NOTE:** Pressing the OFF button does not reset or stop the timer.

1. Press the button and set the desired time using the arrows and confirm with the button . To switch the selection between hours and minutes use the arrows .
2. The time can be set from 1 minute to 12 hours and 59 minutes and, when set, the remaining time is always visible in the bottom status bar until the time expires or is reset.
3. To change or cancel the time set, you must reset the timer by pressing and holding the button for a few seconds.
4. Timer format is usually HR:MIN, switching into MIN:SEC during the last minute.
5. When the time expires, the display shows 00:00 and the buzzer will sound for one minute or until the button is pressed.

### **Preheating the Oven**

- Selecting a higher temperature does not shorten the preheat time.
- Preheating is necessary for good results when baking cakes, cookies, pastry and breads.
- Preheating will help to sear roasts and seal in meat juices.
- Place oven racks in their proper position before preheating.
- During preheating, the selected cooking temperature is always displayed.
- A beep will confirm that the oven is preheated and the "detected temperature" will turn off.

### **Operational Suggestions**

- Do not set pans on the open oven door.
- Use the interior oven lights to view the food through the oven door window rather than opening the door frequently.

### **High Altitude Baking**

- When cooking at high altitude, recipes and cooking time will vary from the standard.

## Instructions for initial switch-on

Once the oven has been connected to the power supply for the first time, the control automatically prepares for setting a number of user settings, which remain stored in case of any subsequent switch-on.



**NOTE:** Both at the first and subsequent connections to the power supply, the door lock mechanism performs a calibration run - **in this phase, always keep the door closed.**

- Language
- Temperature & Weight
- Time
- Date

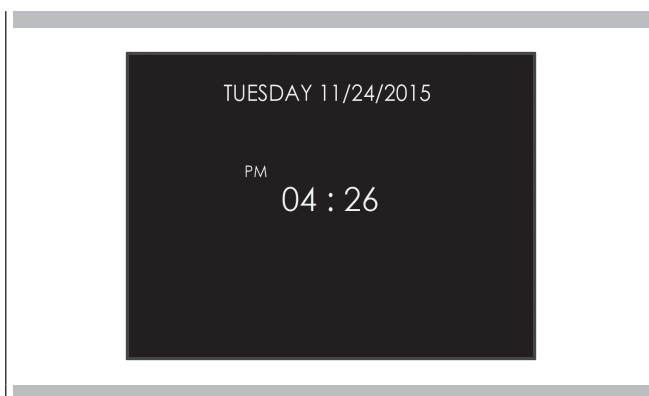

Refer to the **USER SETTING** paragraph for setting instructions.

After making the user settings, the control moves automatically to the "Standby" display page.





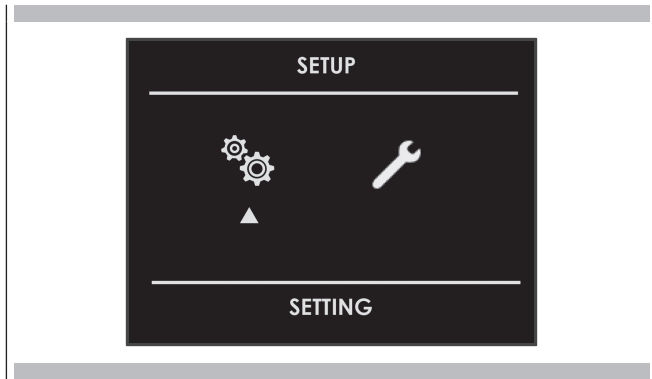

With the oven on, select the icon  and confirm with the key  to enter the SETTINGS menu. This menu permits personalizing the settings of your oven. To make access, no active cooking or any set time functions must be in progress.

**NOTE:** The Setting menù can never be set if any time function is already set: first delete all the active time functions.



1. Press the keys   to select the sub menu and confirm by means of the  key.

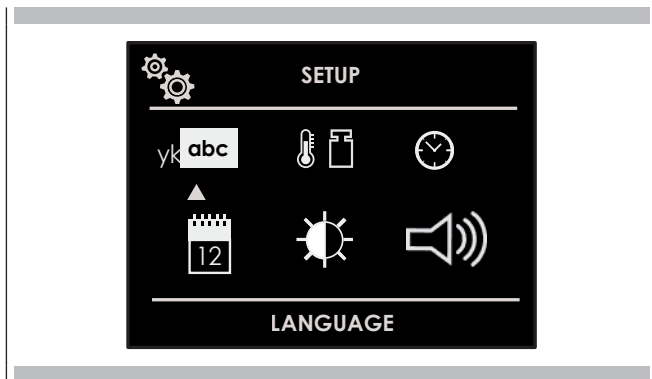

2. Use this menu to change the following settings:  
Press the keys   or   to select the setting or change a sub menu from among the six available ones and confirm by means of the  key.







### Language

Press the arrow key   to select a language from among those available, and confirm with the  key.







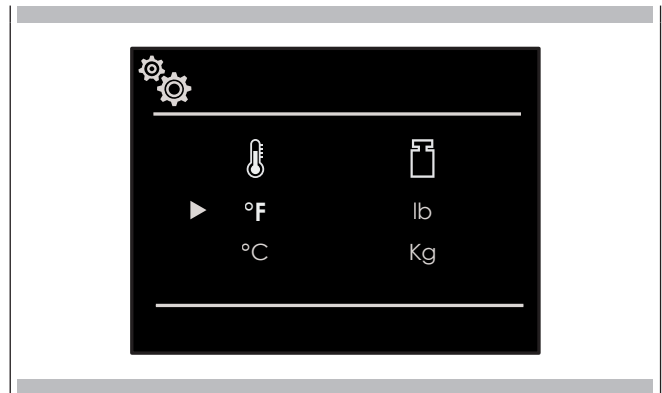

### Temperature & Weight

Press the arrow key   and   to select one of the two temperature options "°C/°F" or weight options Kg/lb and confirm with the  key.



### Time

Press the arrow key   to select the time format between the options "12h AM/PM or 24h" and confirm with the  key. Subsequently, set the time using the arrows   and confirm with the  key.

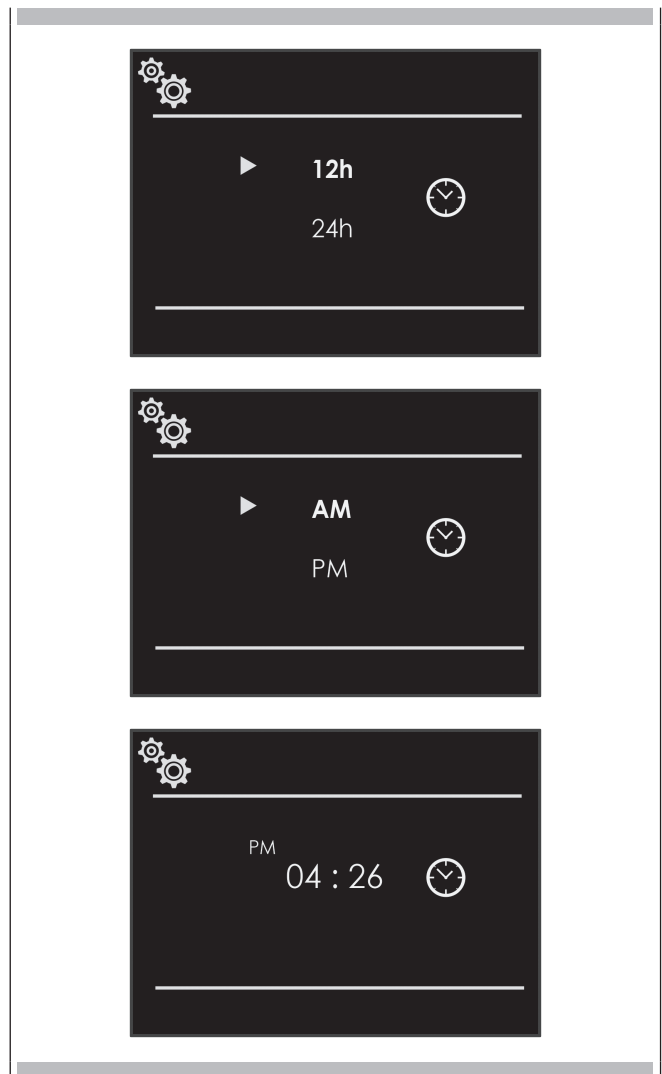

## Date

Press the arrow key  $\Delta \nabla$  to select the date format from among the options "D.M.Y. - Y.M.D. - M.D.Y." and confirm with the  $\square$  key. Subsequently set the value using the arrows  $\Delta \nabla$  and confirm with the  $\square$  key.

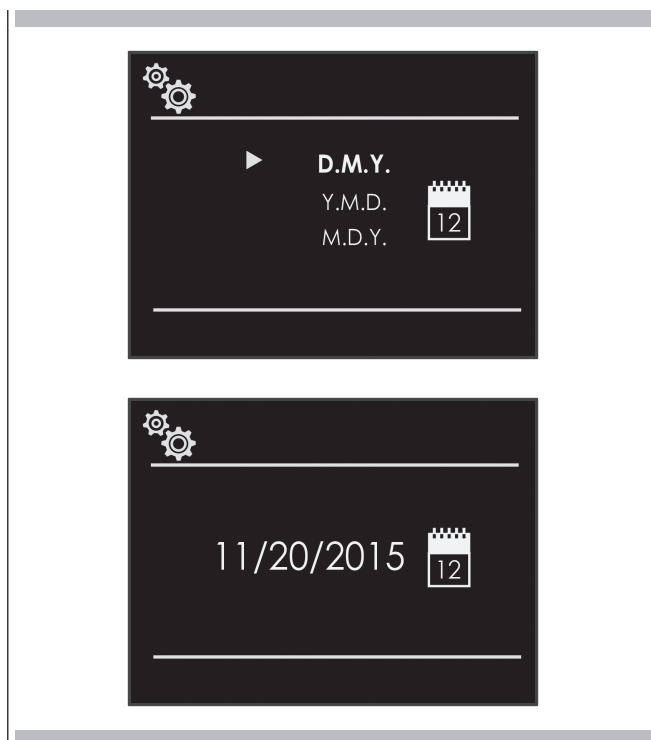

## Volume



Press the arrow key  $\Delta \nabla$  to select the required degree of luminosity and confirm with the key  $\square$ .



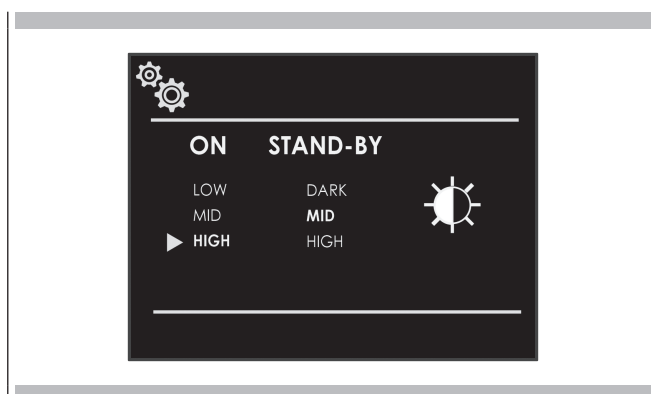

## Brightness



Press the arrow key  $\triangleleft \triangleright$  to choose which luminosity setting to change between ON or STANDBY, then by means of the arrows  $\Delta \nabla$  select the required degree of luminosity and confirm with the  $\square$  key.

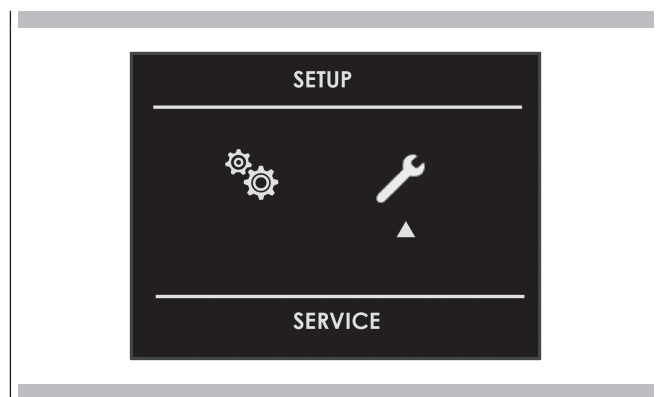

With the oven on, select the icon  and confirm with the key  to enter the SETTINGS menu. This menu permits setting a number of parameters or special functions. It also permits accessing the error events list.

1. Press the keys   to select the sub menu and confirm with the  key.





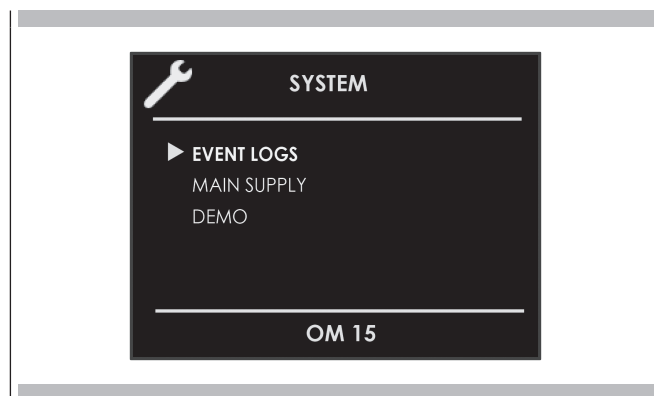

2. Use this menu to change the following settings:  
Press the keys   to select the item to be set or to be displayed from among the three available ones and confirm with the  key.



### Demo

The purpose of this function is to set the DEMO mode, which makes the oven useless for cooking but automatically performs a demonstration of functions.

1. Press the keys   to select the item ON.
2. Confirm with the  key.
3. Press the  key.

After about 30 seconds, the oven starts to operate in this mode.

To temporarily stop the DEMO function, simply keep any key pressed for a few seconds until the oven switches to standby.

To start it again, press the  key.

To disable the function, enter the DEMO display page and set OFF. Confirm using the  key.

**NOTE:** Once set, the function remains enabled even if the oven is disconnected from the power mains.

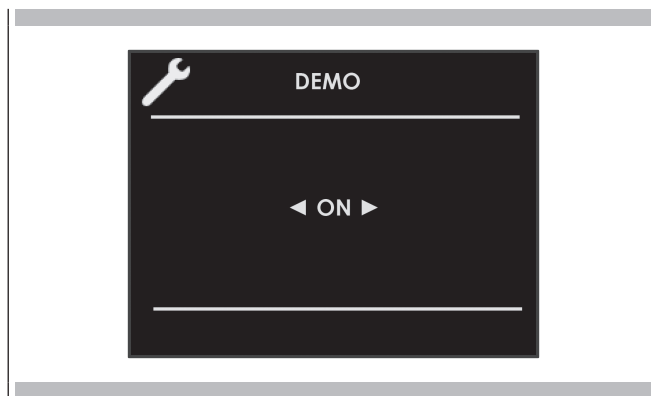

### Event Log

The menu permits checking any recorded errors. These codes can be notified to the after-sales service.

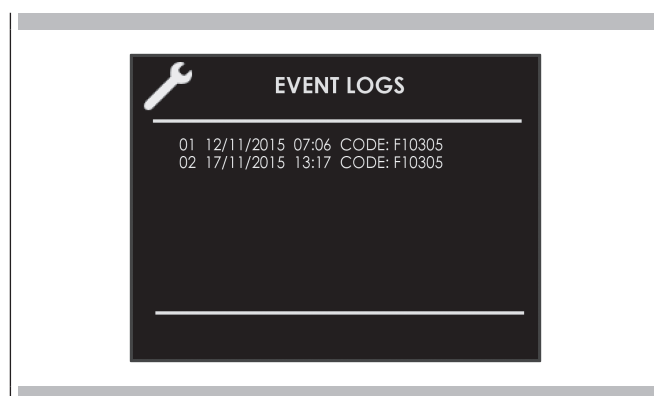









## Switching the oven on and off











### IMPORTANT

- The  key does not stop the function.
- After switching off the oven, the cooling fan could continue to operate until the inner parts of the oven have cooled down.









Press  to switch the oven on and press again to switch it off. The oven returns to standby mode.

## Selecting the cooking mode





Traditional Cooking	
	TRUE CONVEC
	RING & GRILL
	CONVECTION BROIL
	BROIL
Steam Cooking	
	STEAM 100
	STEAM 130
	STEAM & RING
	CLEAN STEAM OVEN
	CLEAN STEAM CIRCUIT

1. Select the icon  and press the key  Select the appropriate cooking mode according to the food to be cooked using the arrows   and   confirm with the key .
2. On this display page, it is still possible to change the cooking mode by using the   keys.
3. If the proposed temperature is correct, confirm with the  key to start cooking, otherwise, if the  key is not pressed within 10 seconds, the oven switches to automatic mode and the cooking mode icon becomes animated.

## Cooking Mode Tables

COOKING MODE	ICON	TEMPERATURE		
		Min.	Preset	Max.
TRUE CONVECTION		50° C	165° C	230° C
RING & GRILL		50° C	210° C	230° C
CONVECTION BROIL		50° C	165° C	230° C
GRILL		50° C	230° C	230° C
STEAM 100		40° C	100° C	100° C
STEAM 130		70° C	130° C	130° C
STEAM & RING		50° C	165° C	230° C
CLEAN MODE	ICON	TEMPERATURE		
		Min.	Preset	Max.
CLEAN STEAM OVEN		-	100° C	-
CLEAN STEAM CIRCUIT		-	-	-





## Changing the cooking mode

1. During untimed cooking, a cooking pause can be set by pressing the  key. All the settings of the suspended cooking operation remain stored and can be reactivated by pressing the same key again.
2. To change the cooking mode while the oven is working, press the  key and then the  key. At this point, another cooking mode can be selected from among those available in the group by means of the arrows  .

## Changing temperature



### IMPORTANT

- At the end of a function, the display screen shows the residual compartment heat temperature from the standby page.
1. From the cooking mode preview display page, the temperature can be changed by means of the arrows   subsequently confirming by means of the  key.
  2. Once cooking has started, the temperature can in any case be changed, at any time, by means of the arrows  .

## Pre-heating phase

While the oven is in pre-heating phase, the instantaneous temperature is displayed underneath the cooking mode icon.

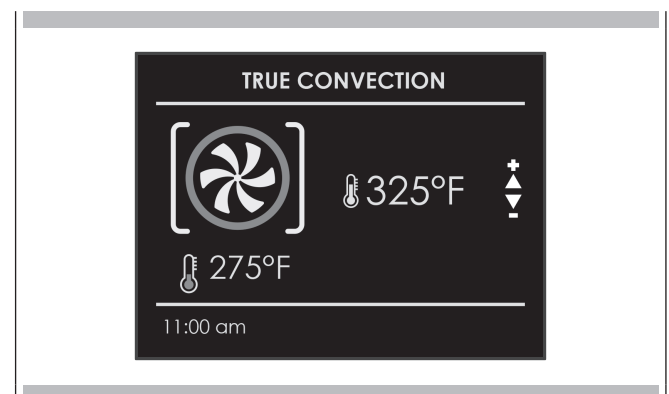

Just as soon as the set temperature is reached, an acoustic signal is heard and the instantaneous temperature indication disappears.

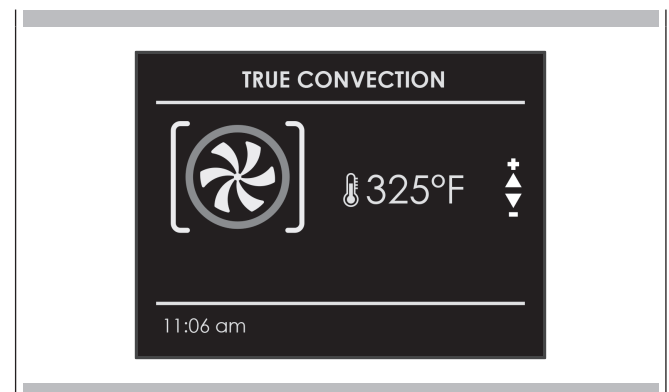

NOTE: it is essential to carefully read the instructions and warnings to ensure correct use.

### Steam operation

Steam cooking is used most for oriental cuisine but it is certainly very useful for our own.

It is fat free and has the advantage of preserving the original flavour of the food.

In this case, the food is not cooked with water but with water vapour.

Steam cooking is different than boiling. In fact, the water vapour works on the inside of the cells, which is fundamentally different from the effect of boiling water.

In fact, steam also cooks the food completely but, except for the fat, nothing else comes out of the food.

The cell walls and tendons gradually soften, the protein coagulates without coming out, the starches swell and combine and the sugars and minerals remain unchanged.

The same goes for odours, which are reduced to a minimum, or coloured substances.

Only the fat liquefies due to the heat and, for this reason, it is almost never a good idea to steam cook large cuts of meat or fish. Vitamins are another story because heat generally tends to destroy them; however, depending on the cooking time, some of them are only slightly altered. So, the foods that lend themselves to this cooking method are, generally, those with no fat such as, for example, fish, some types of meat, legumes, potatoes, cereals, eggs, pudding, vegetables, etc.

It is not good for vegetables with tough fibres or fruits in general.

### Useful tips

When using the steam oven, always start with the oven cold. Using steam in a hot oven (immediately after traditional cooking) is not recommended because the benefits of cooking with steam will be cancelled out.

For steam cooking try to use the perforated stainless steel tray together with the lower stainless steel drip tray as much as possible.

The first, resting with its support on the flat grill, allows the steam to fully cook the food while draining everything released by the food during cooking through the holes.

The second, lower tray, slid under the grill on its guides, will collect the drippings and keep the oven chamber cleaner.

When done cooking, the support of the perforated tray can be used as a support to keep the hot tray off of the counter while you remove the food you just cooked.



#### ATTENTION

Before using any steam functions, the water container must be filled.

If while the oven is on, the message CHECK WATER CONTAINER appears on the display (acoustic signal will sound), open the door, watching out for the hot steam that will be released, extract the container and refill it. When the door is closed, the oven will go into PAUSE mode. Press the key  to continue cooking.

NOTE: The steam functions will not start until the door is closed. If the door is open, the message CLOSE THE DOOR will be shown on the display. If the door is opened while the oven is on, the oven will go into pause mode. To restart the function, the door needs to be closed.

Select the desired function and confirm using the key , at this point the circuit will be filled. As soon as the water reaches the right temperature, the steam generated by the boiler will enter the cavity.

The function can be paused at any time using the key , when it is pressed again  the function restarts.

### Steam Cooking

#### Steam 100

By way of radial ventilation, the steam is distributed to ensure the food is evenly heated and cooked.

This holds the advantage of being able to cook on the three different levels at the same time, taking care to insert the more "full-bodied" food on the higher level, and less dense foods such as vegetables on the lower levels (from the first to the third).

NOTE: during steam cooking, always place the lower stainless steel tray underneath the perforated cooking container, to collect any food scraps or condensate that may eventually fall.

#### Steam 130

During regeneration, the cooking chamber is heated with steam and warm air, which allows rapid and consistent heating of the food without drying it.

Based on the type of food being reheated, this programme offers the possibility to modify the temperature inside the oven so as to manage this function as you please. This type of function is therefore particularly suitable for:

- Heating pre-cooked food from 70°C to 130°C;
- Preparing ready and semi-ready meals, frozen foods from 70°C to 130°C

NOTE: for these types of meals, remember to insert suitable dishes in the oven (not made from synthetic or similar materials) and to position them above the grill, making sure to remove any lids.

#### ATTENTION

Once the functions have been completed, a circuit discharge request will be sent (see WATER DISCHARGE paragraph).

## Combined Steam and Convection Cooking

This type of cooking is called “professional cooking” because the food being cooked is placed into a cold chamber that has not been preheated.

After starting the oven, the food is initially exposed to steam (or “steamed”). After a short period of exposure to the steam, depending on the filling volume and therefore on the size of the food being cooked, the appliance automatically moves on to the second warm air phase.

This type of function is particularly suited to large meat and seafood dishes for example; large sized bread loaves made from white or wholemeal flour, with yeast or yeast dough at 190°C until 210°C, as well as filled and hollow puff pastry, whether fresh or frozen from 190°C to 210°C.

NOTE: For best results when running two consecutive “professional cooking” programmes, the oven must be cooled before inserting the second dish.



### ATTENTION

Once the functions have been completed, a circuit discharge request will be sent (see WATER DISCHARGE paragraph).





## Steam Assist Function

This particular function can only be used with traditional oven functions.



Once the oven has been turned on, the steam assist function will only become available once the internal oven temperature has exceeded 100°C. Only from that moment on will the symbol  appear on the lower part of the display.

NOTE: THIS FUNCTION IS NOT ENABLED DURING STEAM COOKING.

To inject steam inside the cavity, press the key  select the icon  using the arrows  and  and confirm using the key .

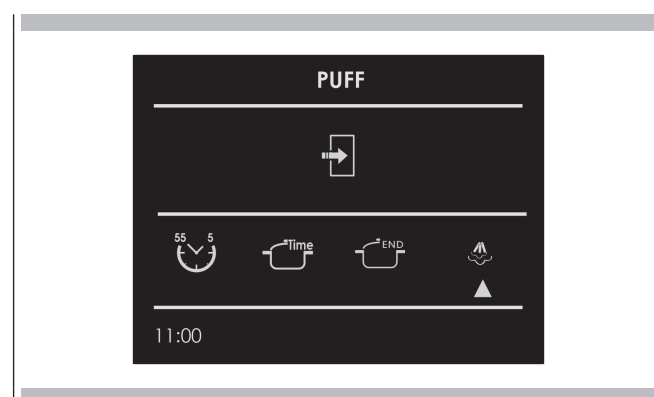

The steam assist function will be enabled and the change in status can be seen on the animated display. The steam assist function will continue for 5 minutes, humidifying the food so that it doesn't dry out during cooking. Ideal for roasts in general, large meat/seafood dishes and softer cooking.

After 5 minutes, the oven returns to the previously set cooking function.

A single light key activates the lights.

Touch  to turn lights on or off .

Oven lights turn on automatically when the door is opened.

When an oven is in use, oven lights turn on automatically when a mode is started.

Oven lights will turn off automatically when the oven mode is cancelled.

**NOTE:** Once switched on, the lights go off automatically after 3 minutes. To switch them back on, press the key or open the door.

Be sure that the time-of-day clock is displaying the correct time. The timed mode turns off the oven at the end of the cook time.

## CAUTION







Never leave food in the oven for more than one hour before and after cooking. This could deteriorate the properties of the food itself.

**NOTE:** The time functions cannot be used if the meat probe is on. The maximum cooking time that can be set is 12 h.

## Cook Time



Use the "Cook Time" function to operate the oven for a determinate period of time. The oven starts immediately and switches off automatically once the time has expired.

### To Set a Timed Mode

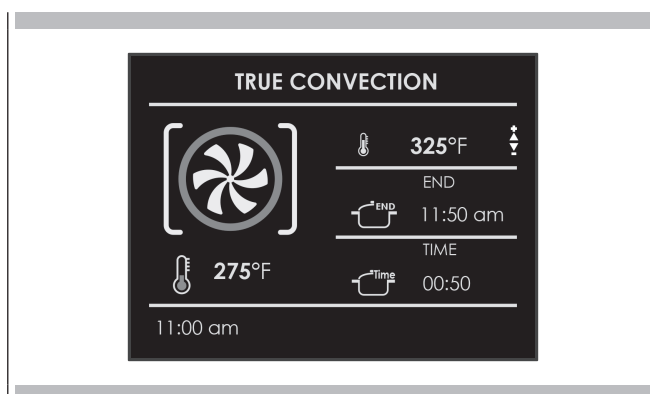
1. Select the cooking mode and temperature.
2. There are two ways to set the function.
  - a) Select  to set the duration and press .
  - b) Select  to set the stop time and press .
3. After selecting one of the two above options, set the time by means of the arrows  $\Delta$   $\nabla$  and confirm with the  key.
4. After pressing the  key, cooking starts and the time cooking information is shown on the display page.
  - Cooking mode
  - Temperature
  - Cooking time
  - End of cooking time







- 5 After cooking, the oven switches off and an acoustic signal warns that cooking has terminated.

To change the cooking time when the oven is already operating, simply press the  key and enter the new cooking time before pressing the  key again.

## Stop Time



Use the "Stop Time" function to delay the start of timed cooking. Enter the cooking stop time and the oven will automatically calculate the start time. The oven switches on and off automatically.

### To Delay the Start of a Timed Mode

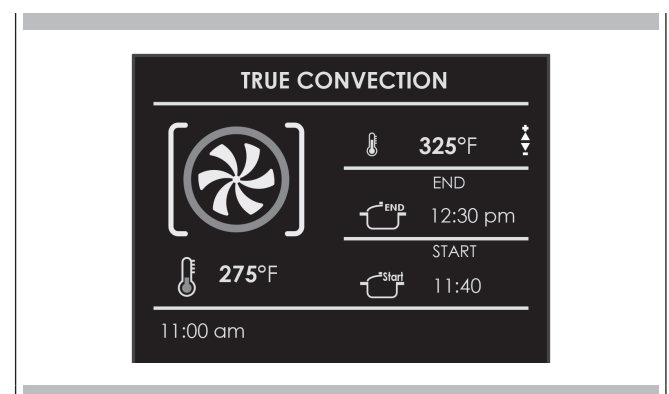
- 1 First of all set the required timed cooking as indicated in the "COOK TIME" paragraph.
- 2 Select  to set the stop time and press .
- 3 Set the cooking stop time by means the arrows  $\Delta$   $\nabla$  and confirm by means of the  key.
- 4 After pressing the  key, the function positions in standby and the postponed cooking details are shown on the screen.
  - Cooking mode
  - Temperature
  - Cooking stop time
  - Cooking start time



- 5 After cooking, the oven switches off and an acoustic signal warns that cooking has terminated.

To change the cooking time and stop time when the oven is already operating, simply press the key  and enter the new cooking time or cooking stop time and press the key  again.

When roasts, steaks or poultry are being cooked, this is the best way to tell when the food is correctly cooked.

This oven is optionally provided with the meat probe feature to sense the temperature inside meat and stop cooking as soon as the set value is reached.

When the probe is used, the oven automatically checks the cooking time.

**NOTE :** the food probe is an accessory available only in some versions of the product.

Tenderness, aroma and flavour are the result of precise, functional control.

The food probe is a thermometer which, when inserted into the food, makes it possible to check the internal temperature and use it to establish the end of cooking.

For example, meat may look like it is cooked on the outside, but still be pink on the inside!

The temperature reached by food during cooking is closely linked to problems relating to health and hygiene. Bacteria can be contained in every kind of meat, poultry and fish, as well as raw eggs.

Certain types of bacteria make food go off, while others, such as Salmonella, Campylobacter jejuni, Listeria monocytogenes, Escherichia coli and Staphylococcus aureus can be seriously harmful to human health. Bacteria multiply very quickly above a temperature of 4.4° up to 60°C. Mince is particularly at risk from this point of view.

To prevent bacteria from multiplying, it is necessary to take the following measures:

- Do not defrost food at room temperature, always in the fridge or in the oven using the specific function. In the latter case, cook the food immediately afterwards.
- Stuff chicken just before eating it. Never buy pre-packed ready-stuffed chicken and only buy ready-cooked stuffed chicken when you intend to eat it within 2 hours.
- Marinate food in the fridge, not at room temperature.
- Use a food probe to check the temperature of meat, fish and poultry if they are more than 5 cm thick, to ensure that the minimum cooking temperatures are reached.
- The greatest hazards are posed by poorly cooked chicken, particularly at risk from Salmonella.
- Avoid interrupting the cooking process, i.e., partially cooking food, storing it and completing the cooking process later. This sequence encourages the growth of bacteria due to the "warm" temperatures reached inside the food.
- Roast meat and poultry in the oven at temperatures of at least 165°C.



**IMPORTANT**

Use only the meat probe supplied with the appliance.

In any case, we recommend that you consult the following table taken from the National Food Safety Database (USA).

Food	Minimum internal temperature
<b>Mince</b>	
Hamburger	71° C
Beef, veal, lamb, pork	74° C
Chicken, turkey	74° C
<b>Beef, veal, lamb</b>	
Roasts and steaks:	
Rare	The cooking temperature for rare meat is not indicated by the NFSD as it is unsafe for health reasons
Medium-rare	63° C
Medium	71° C
Well done	77° C
<b>Pork</b>	
Chops, roasts, ribs:	
Medium	71° C
Well done	77° C
Fresh ham	71° C
Fresh sausages	71° C
<b>Poultry</b>	
Whole chicken or chicken pieces	82° C
Duck	82° C
Whole turkey (not stuffed)	82° C
Turkey breast	77° C

## ⚠ WARNING

- To avoid burns, use a kitchen glove to fit and remove the meat probe when the oven is hot.
- Always remove the probe using the grip. If it is removed by pulling the cable, it could suffer damage.
- Make sure the food is completely de-frozen when the probe is fitted. Otherwise it could suffer damage.

**NOTE:** - The meat probe is not enabled for all functions (meat probe function not available also for Recipes).  
If it is fitted during one of these functions, a probe removal message appears on the screen.

- If the meat probe is accidentally removed during operation, a warning message appears on the screen.
- The temperature of the probe can be set between 104°F and 212°F (40°C - 100°C).
- The oven stores the last temperature set by the user.

## How use the food probe

As you can see from Figure, the probe socket is located in the upper left corner of the oven chamber, protected by a metal cover with plug.

Remove the cover and insert the plug of the probe all the way (you will hear a slight confirming click).

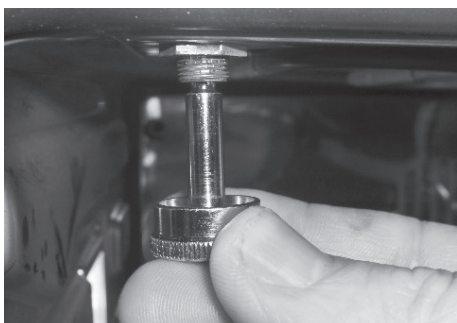

Insert the probe in the food without touching fatty parts or bones.



## ⚠ WARNING

Remember that the probe will not work if it is connected when the oven is already switched on!

Insert the tip of the probe in the central and thickest part of the meat.

Make sure the probe is not in contact with the fat, bone, oven parts or dishes.

The meat probe is automatically recognised when it is inserted and the icon appears  on the screen.

When a cooking mode is started with the probe inserted, the display page for setting the function appears automatically.

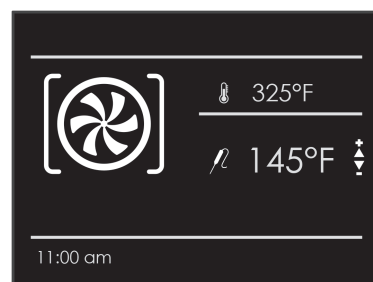

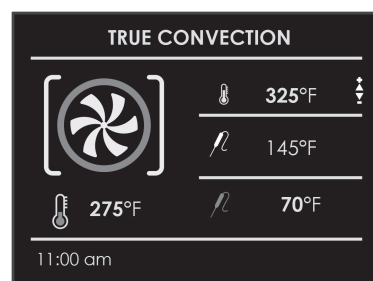

1. Set the required probe temperature by means of the arrows   and confirm with the  key.



2. After pressing the  key, cooking starts and all probe cooking details appear on the screen.







- Cooking mode
- Oven temperature
- Set probe temperature
- Instantaneous probe temperature

Once the set probe temperature is reached, the oven switches off and an acoustic signal warns that cooking has terminated.







**NOTE:** After cooking has started, the oven temperature can in any case be changed at any time by means of the arrows  .

To change the probe temperature, press the  key and then the  key and finally, the  key again.

The Recipe function of your oven gives you the chance to cook food without having to set the oven manually every time. By selecting a "SET" recipe, the cooking mode, the temperature and the time are automatically set according to the recipe selected from the menu.

Recipe List	Type of Food	Food condition	Recipes List	Information displayed
PRESET OR PERSONAL		FRESH	BREAD PIZZA FIRST	TYPE OF ACCESSORY LEVEL POSITION FOOD WEIGHT COOKING TIME PREHEAT REQUIRED (YES/NO)
		FROZEN		
		WHOLE	MEAT	
		IN PEICES		
		WHOLE	POULTRY	
		IN PEICES		
		WHOLE	FISH	
		IN PEICES		
		-	VEGETABLES	
		-		
		-	PIES	
		-		

**Select an already-set recipe:**





1. Switch the oven, select the icon  and press the button .
2. Using the arrows  $\Delta$   $\nabla$  select the list between "PRESET" or "PERSONAL" and confirm by means of the  key.
3. Choose the type of food to be cooked using the arrows  $\Delta$   $\nabla$  and the arrows  $\triangleleft$   $\triangleright$  and confirm by means of the  key.
4. Using the arrows  $\Delta$   $\nabla$  choose between "FRESH" or "FROZEN" or in other cases between "WHOLE" or "IN PEICES" and confirm with the  key.
5. Select the required recipe by means of the arrows  $\Delta$   $\nabla$  and confirm using the  key.
6. When the recipe is selected, the following display page appears on the screen:





- To start the recipe, confirm with the  key.  
During a recipe, a number of acoustic and visual messages will ask you to perform the following operations. Simply follow the instructions on the screen.
- Upon termination, the oven switches off and an acoustic and visual signal warns that the recipe has terminated.

### Saving a personalized recipe:

Once a recipe has been selected, the "Time" and "Weight" setting can be changed and the recipe can be saved among the "PERSONAL" ones.

- Once a recipe has been selected, press the key  and confirm by means of the .
- To change the weight, enter the desired weight by means of the arrows   and confirm by means of the .



- The oven switches automatically to the cooking time. To change this time, use the arrows   and confirm again by means of the .

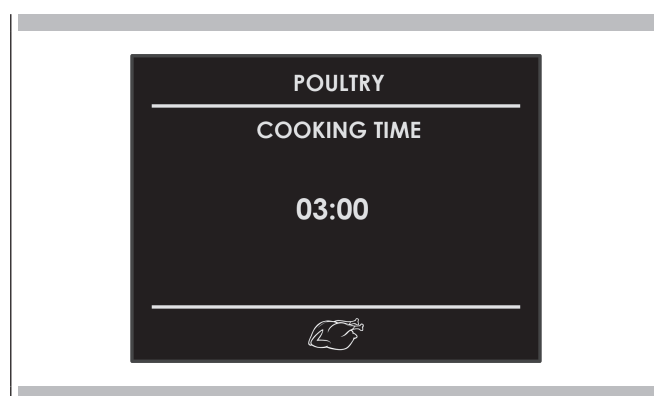



- At this point, the recipe can be saved in the list of "PERSONAL" recipes by selecting "SAVE" and confirming by means of the .



**NOTE:** If the time and weight values are changed and not saved straight away, at the end of the recipe, a message appears which asks whether you want to save it.

- To start the recipe press the .

### Cancelling a Personalized recipe:

- To eliminate a recipe from the list of personalized recipes, select the recipe.
- Press the key  and select the choice and confirm with the .

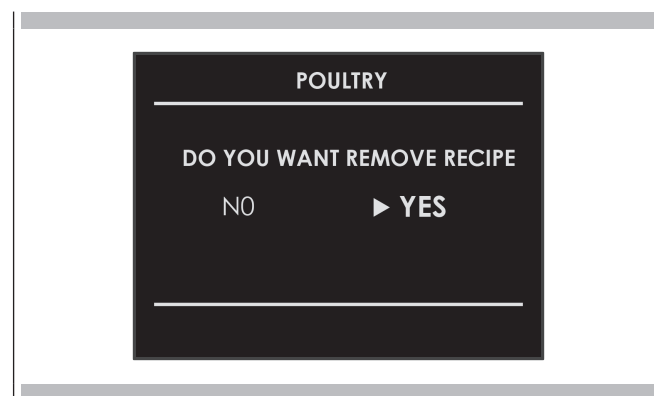

## Oven Clean

This function performs a cleaning cycle by injecting steam into the cavity for 15 minutes. At the end of the cycle, any crusting that may have formed due to high-temperature cooking inside the oven cavity, will be softened and become much easier to remove.

### ATTENTION

Once the functions have been completed, a circuit discharge request will be sent (see WATER DISCHARGE paragraph).

## Circuit Clean

This function performs a cleaning cycle of the circuit, to keep it clean and efficient over time.

### ATTENTION

Once the functions have been completed, a circuit discharge request will be sent (see WATER DISCHARGE paragraph).

**This oven is one of its kind insofar as it does not require any descalers to keep the steam generation system running efficiently.**

## Circuit discharge

At the end of any steam function, when the oven is turned off using the key  a circuit discharge is requested.

The following message will appear on the display: NEED TO DISCHARGE / OPEN THE DOOR.

Open the door, watching out for the hot steam that will be released. A new message will appear on the display with an animated icon, requesting the user to extract the container until the symbol indicated on the same. Press the key  to start the steam circuit discharge.



At the end of the procedure, the message DISCHARGE ENDED / REMOVE AND EMPTY THE TANK will appear on the display, confirming that the discharge was successful. If you do not wish to immediately repeat a new steam cooking cycle, it is recommended to empty the container and replace it in its housing, then close the door.

The oven is now ready for a new cooking cycle.

**IMPORTANT**

The oven lamp must have precise characteristics:

- a) Structure suitable for high temperatures (up to 300 °C);
- b) Power supply: see the V/Hz value on the serial number plate;
- c) power 25 W;
- d) Type G9 connector.

**Attention: make sure the appliance is off before replacing the lamp to avoid the possibility of electric shock.**

- To avoid damage, spread a tea towel for pots and pans inside the oven;
- Remove the screws holding the steel frame;
- Remove the old lamp by sliding it out of its seat and taking care not to break it;
- Insert the new bulb taking care not to touch it with your hands (we recommend using a disposable latex glove);
- Replace the stainless steel frame taking care not to pinch the silicone gasket seal;
- Screw in the stainless steel screws you previously removed
- Connect the appliance to the power line.



### Installing the oven in a cabinet

The oven must be installed under a cook top, in a column, or combined with the relative food-warmer drawer. The dimensions of the space must be those shown in the figure. The cabinet material must be able to withstand the heat. The oven must be centred within the walls of the cabinet and fixed with the screws and bushings that are provided.

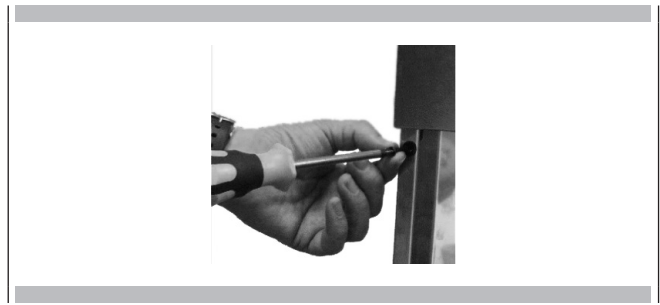

#### CUTOUT & DIMENSIONS

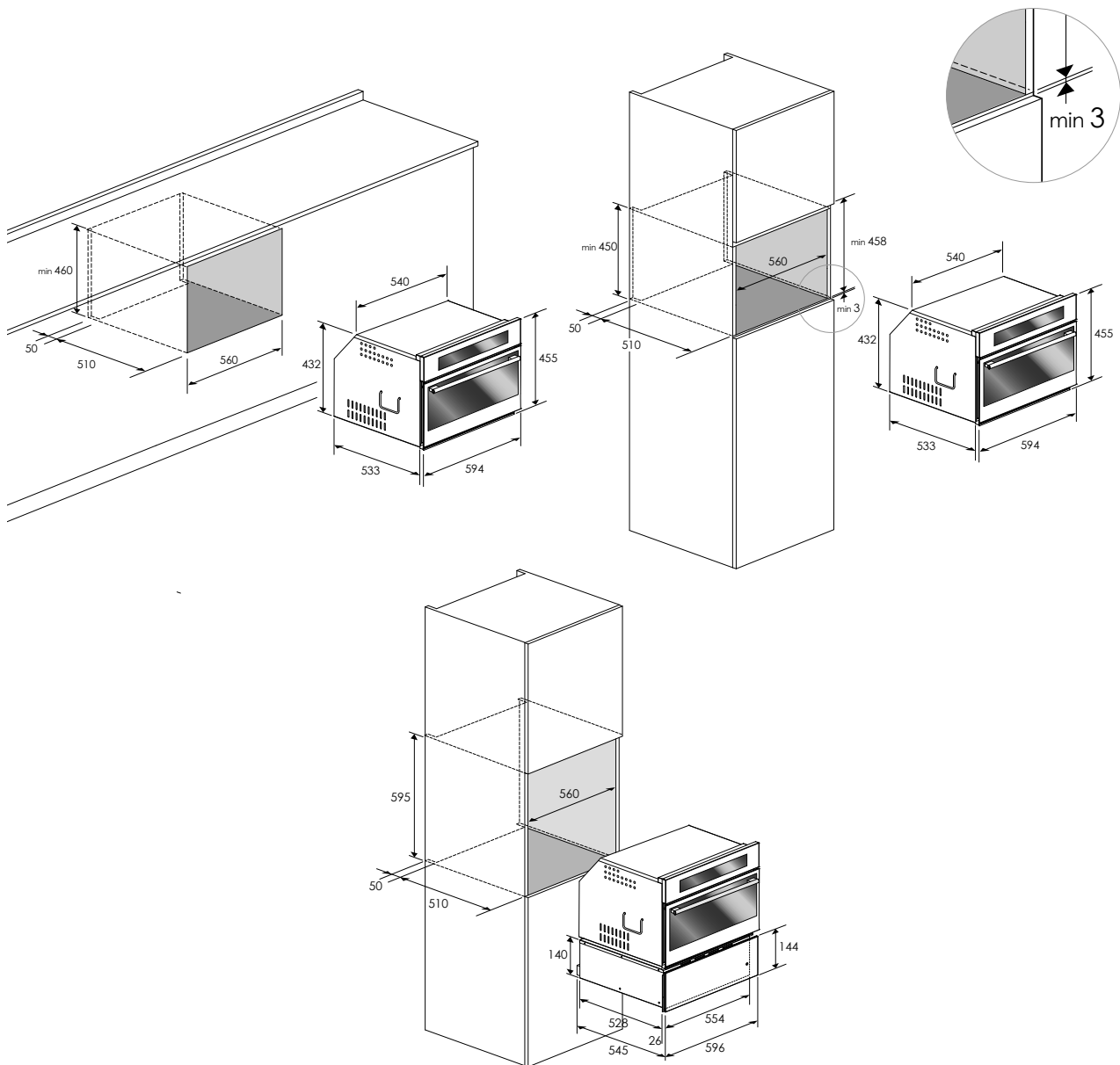

## Electrical Hook-Up

Before connecting to the electricity, make sure that:

- the characteristics of the electrical system satisfy what is shown on the serial number plate applied to the front of the oven;
- the system has an effective earth connection compliant with current standards and laws.

The earth connection is required by law. The cable must not, at any point, reach a temperature greater than 50 °C above the ambient temperature.

This oven must be connected to the electricity through a power supply cable and plug that is compatible with the outlet of the electrical system that powers this oven.

If a fixed appliance does not have a power cord and plug, or another device that ensures disconnection from the mains, with an opening distance of the contacts that allows complete disconnection under the conditions of excessive voltage category III, such disconnection devices must be provided in the power supply mains conforming to the installation rules.

The omnipolar socket or switch must be easy to reach when the appliance is installed.

**Note:** The manufacturer declines all liability if the usual accident prevention standards and the above instructions are not followed.

### TYPE AND MINIMUM DIAMETER OF THE CABLES

		SASO	
H05RR-F	3x1,5 mm <sup>2</sup>	H05RR-F	3x2,5 mm <sup>2</sup>
H05VV-F	3x1,5 mm <sup>2</sup>	H05VV-F	3x2,5 mm <sup>2</sup>
H05RN-F	3x1,5 mm <sup>2</sup>	H05RN-F	3x2,5 mm <sup>2</sup>
H05V2V2-F	3x1,5 mm <sup>2</sup>	H05V2V2-F	3x2,5 mm <sup>2</sup>

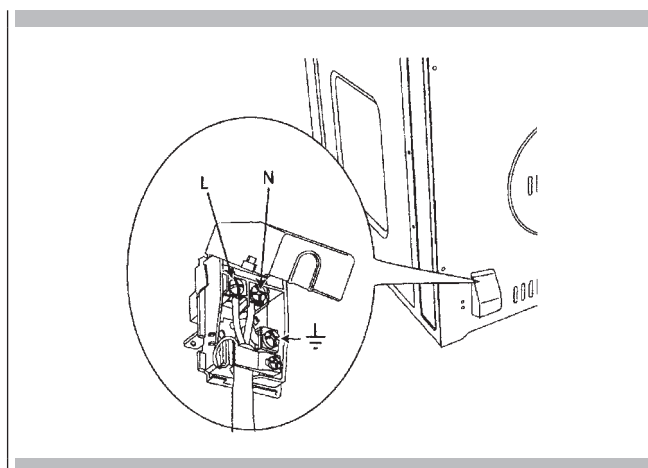

With either Bake or Convection Bake, poor results can occur for many reasons other than a malfunction of the oven. Check the chart below for causes of the most common problems. Since the size, shape and material of baking utensils directly affect the baking results, the best solution may be to replace old baking utensils that have darkened and warped with age and use.

Baking Problem	Cause
Food browns unevenly	<ul style="list-style-type: none"> <li>- Oven not preheated</li> <li>- Aluminum foil on oven rack or oven bottom</li> <li>- Baking utensil too large for recipe</li> <li>- Pans touching each other or oven walls</li> </ul>
Food too brown on bottom	<ul style="list-style-type: none"> <li>- Oven not preheated</li> <li>- Using glass, dull or darkened metal pans</li> <li>- Incorrect rack position</li> <li>- Pans touching each other or oven walls</li> </ul>
Food is dry or has shrunk excessively	<ul style="list-style-type: none"> <li>- Oven temperature too low</li> <li>- Oven not preheated</li> <li>- Oven door opened frequently</li> <li>- Tightly sealed with aluminum foil</li> <li>- Pan size too small</li> </ul>
Food is baking or roasting too slowly	<ul style="list-style-type: none"> <li>- Oven temperature too low</li> <li>- Oven not preheated</li> <li>- Oven door opened frequently</li> <li>- Tightly sealed with aluminum foil</li> <li>- Pan size too small</li> </ul>
Pie crusts do not brown on bottom or have soggy crust	<ul style="list-style-type: none"> <li>- Baking time not long enough</li> <li>- Using shiny steel pans</li> <li>- Incorrect rack position</li> <li>- Oven temperature is too low</li> </ul>
Cakes pale, flat and may not be done inside	<ul style="list-style-type: none"> <li>- Oven temperature too low</li> <li>- Incorrect baking time</li> <li>- Cake tested too soon</li> <li>- Oven door opened too often</li> <li>- Pan size may be too large</li> </ul>
Cakes high in middle with crack on top	<ul style="list-style-type: none"> <li>- Baking temperature too high</li> <li>- Baking time too long</li> <li>- Pans touching each other or oven walls</li> <li>- Incorrect rack position</li> <li>- Pan size too small</li> </ul>
Pie crust edges too brown	<ul style="list-style-type: none"> <li>- Oven temperature too high</li> <li>- Edges of crust too thin</li> </ul>

Before contacting service, check the following to avoid unnecessary service charges.

Oven Problem	Problem Solving Steps
Other F__ Error appears in the display window.	Remove power and turn it back on again after a few seconds. If condition persists, note the code number (in the EVENT LOG list) and contact service.
The oven display stays OFF	Turn off power at the main power supply (fuse or breaker box). Turn breaker back on. If condition persists, call an authorized service.
Cooling fan continues to run after oven is turned off	The fan turns off automatically when the electronic components have cooled sufficiently.
Oven is not heating	Check the circuit breaker or fuse box to your house. Make sure there is proper electrical power to the oven. Make sure the oven temperature has been selected.
Oven is not cooking evenly	Refer to cooking charts for recommended rack position. Always reduce recipe temperature by 25°F (15°C) when baking with Convection Bake mode.
Oven light is not working properly	Replace or reinsert the light bulb if loose or defective. See Page 25. Avoid touching the bulb glass with bare fingers as finger oil may cause bulbs to burn out prematurely.
Clock and timer are not working properly	Make sure there is proper electrical power to the oven.

Before contacting service, please check "Troubleshooting." It may save you the cost of a service call.  
If you still need help, follow the instructions below.  
When calling, please know the purchase date and the complete model and serial number of your appliance.  
This information will help us to better respond to your request.

### Service Data Record

For authorized service or parts information see paragraph "WARRANTY for Home Appliances".

For serial tag location see Page 3. Now is a good time to write this information in the space provided below.  
Keep your invoice for warranty validation.

Service Data Record	
Model Number	_____
Serial Number	_____
Date of Installation or Occupancy	_____



PRODUCT COD. 2.006.79.1

DOC COD. 2.006.79.1 - 11/16

