



EN FRONT LOAD DRYER
FR SÉCHEUSE À CHARGEMENT FRONTAL
ES SECADORA DE CARGA FRONTAL

USE & CARE GUIDE
GUIDE D'UTILISATION ET D'ENTRETIEN
GUÍA DE USO Y CUIDADO



A04173701B July 2016

2 Finding Information

Please read and save this guide

Thank you for choosing **Electrolux**, the premium brand in home appliances. This *Use & Care Guide* is part of our commitment to customer satisfaction and product quality throughout the life of your new appliance.

We view your purchase as the beginning of a relationship. To ensure our ability to continue serving you, please use this page to record important product information.

Keep a record for quick reference

Purchase date

Electrolux model number

Electrolux serial number

NOTE

Registering your product with Electrolux enhances our ability to serve you. You can register online at www.electroluxappliances.com or by dropping your Product Registration Card in the mail.

NOTE

The instructions appearing in this *Use and Care Guide* are not meant to cover every possible condition and situation that may occur. Common sense and caution must be practiced when installing, operating and maintaining any appliance.

Questions?

For toll-free telephone support in the U.S.: 1-877-4ELECTROLUX (1-877-435-3287) and in Canada: 1-800-265-8352.

For online support and product information visit www.electroluxappliances.com

Save these instructions for future reference.

Table of contents

Finding Information.....	2	Care & Cleaning	18
Safety.....	3-5	Solutions to Common Inquiries.....	19-21
Features.....	6	Warranty.....	22
Operating Instructions.....	7-17		

Important Safety Instructions

Recognize safety symbols, words and labels

Your safety and the safety of others is very important.

We have provided many important safety messages in the *Use and Care Guide*, *Installation Instructions* and on your appliance. Always read and obey all safety messages.

Safety items throughout this manual are labeled with a **WARNING** or **CAUTION** based on the risk type as described below:

WARNING

This symbol alerts you to situations that may cause serious body harm, death or property damage.

CAUTION

This symbol alerts you to situations that may cause bodily injury or property damage.

WARNING

FIRE OR EXPLOSION HAZARD

Failure to follow safety warning exactly could result in serious injury, death, or property damage.

Do not store or use gasoline or other flammable vapors and liquids in the vicinity of this or any other appliance.

WHAT TO DO IF YOU SMELL GAS:

- **Do not try to light any appliance.**
- **Do not touch any electrical switch; do not use any phone in your building.**
- **Clear the room, building or area of all occupants.**
- **Immediately call your gas supplier from a neighbor's phone. Follow the gas supplier's instructions.**
- **If you cannot reach your gas supplier, call the fire department.**
- **Installation and service must be performed by a qualified installer, service agency or the gas supplier.**

240 v Electric Dryer



10-30R
3-wire
(fused 30 amp)



14-30R
4-wire
(fused 30 amp)

UL-approved service cord must be installed on electric dryers (not provided with unit except those manufactured for sale in Canada).

120 v Gas Dryer



Grounding type wall receptacle

Do not, under any circumstances, cut, remove, or bypass the grounding prong.



Power cord with 3-prong grounded plug

Avoid fire hazard or electrical shock. Do not use an adaptor plug or extension cord or remove grounding prong from electrical power cord. Failure to follow this warning can cause serious injury, fire or death.

⚠️ WARNING - RISK OF FIRE

To reduce the risk of fire, electrical shock, or injury to persons when using this dryer, comply with the basic warnings listed below. Failure to comply with these warnings could result in serious personal injuries.

You can be killed or seriously injured if you don't follow these Important Safety Instructions:

PREVENT FIRE

- Do not dry items that have been previously cleaned in, soaked in, or spotted with gasoline, cleaning solvents, kerosene, waxes, or other flammable or explosive substances. Do not store these items on or near the dryer. These substances give off vapors that could ignite or explode.
- Do not place items exposed to cooking oils in your dryer. Items contaminated with cooking oils may contribute to a chemical reaction that could cause a load to catch fire.
- Do not dry articles containing rubber, plastic or similar materials such as bras, galoshes, bath mats, rugs, bibs, baby pants, plastic bags and pillows that may melt or burn. Some rubber materials, when heated, can under certain circumstances produce fire by spontaneous combustion.

⚠️ WARNING

FIRE HAZARD

Clean the lint screen before or after each load. The interior of the dryer, lint screen housing and exhaust duct should be cleaned approximately every 18 months by qualified service personnel. An excessive amount of lint build-up in these areas could result in inefficient drying and possible fire. See Care and Cleaning.

⚠️ WARNING

FIRE HAZARD

A clothes dryer produces combustible lint. The dryer must be connected to an outdoors exhaust. Regularly inspect the outdoor exhaust opening and remove any accumulation of lint around the opening and in the surrounding area.

- Do not operate the dryer if the lint screen is blocked, damaged or missing. Fire hazard, overheating and damage to fabrics can occur.
- Do not obstruct the flow of ventilating air. Do not stack or place laundry or throw rugs against the front or back of the dryer.
- Do not spray any type of aerosol into, on or near dryer at any time.
- Do not use fabric softeners or products to eliminate static unless recommended by the manufacturer of the fabric softener or product.
- Do not continue to use the dryer if you hear squeaking, grinding, rubbing or other unusual noises. This could be a sign of mechanical breakdown and lead to fire or serious injury. Contact a qualified technician immediately.
- Failure to comply with these warnings could result in fire, explosion, serious bodily injury and/or damage to the dryer.

Important Safety Instructions, continued

PROTECT CHILDREN

- Do not allow children to play on or in the dryer. Close supervision of children is necessary when the dryer is used near children. As children grow, teach them the proper, safe use of all appliances.
- Destroy the carton, plastic bag and other packing materials after the dryer is unpacked. Children might use them for play. Cartons covered with rugs, bedspreads or plastic sheets can become airtight chambers.
- Keep laundry products out of children's reach. To prevent personal injury, observe all warnings on product labels.
- Before the dryer is removed from service or discarded, remove the dryer door to prevent accidental entrapment.
- Failure to comply with these warnings could result in serious personal injuries.

PREVENT INJURY

- To prevent shock hazard and assure stability during operation, the dryer must be installed and electrically grounded by a qualified service person in accordance with local codes. Installation instructions are packed in the dryer for the installer's reference. Refer to *Installation Instructions* for detailed grounding procedures. If the dryer is moved to a new location, have it checked and reinstalled by a qualified service person.
- To prevent personal injury or damage to the dryer, the electrical power cord of a gas dryer must be plugged into a properly grounded and polarized 3-prong outlet. The third grounding prong must never be removed. Never ground the dryer to a gas pipe. Do not use an extension cord or an adaptor plug.

- ALWAYS disconnect the dryer from the electrical supply before attempting any service or cleaning. Failure to do so can result in electrical shock or injury.
- Do not use any type spray cleanser when cleaning dryer interior. Hazardous fumes or electrical shock could occur.
- To prevent injury, do not reach into the dryer if the drum is moving. Wait until the dryer has stopped completely before reaching into the drum.

PREVENT INJURY AND DAMAGE TO THE DRYER

- All repairs and servicing must be performed by an authorized servicer unless specifically recommended in this *Use & Care Guide*. Use only authorized factory parts.
- Do not tamper with controls.
- Do not sit on, step on or stand on the dryer. Do not rest heavy loads on top. The dryer is not meant to support weight.
- Do not install or store the dryer where it will be exposed to the weather.
- Thermal limiter switches automatically turn off the motor in the unlikely event of an overheated situation. A service technician must replace the thermal limiter switch(es) after correcting the fault.
- Failure to comply with these warnings could result in serious personal injuries.

Read all instructions before operating this dryer.

CAUTION

The California Safe Drinking Water and Toxic Enforcement Act requires the Governor of California to publish a list of substances known to the state to cause cancer, birth defects or other reproductive harm, and requires businesses to warn customer of potential exposure to such substances. Included in this list are soot and carbon monoxide, both of which may be produced by the use of this product.

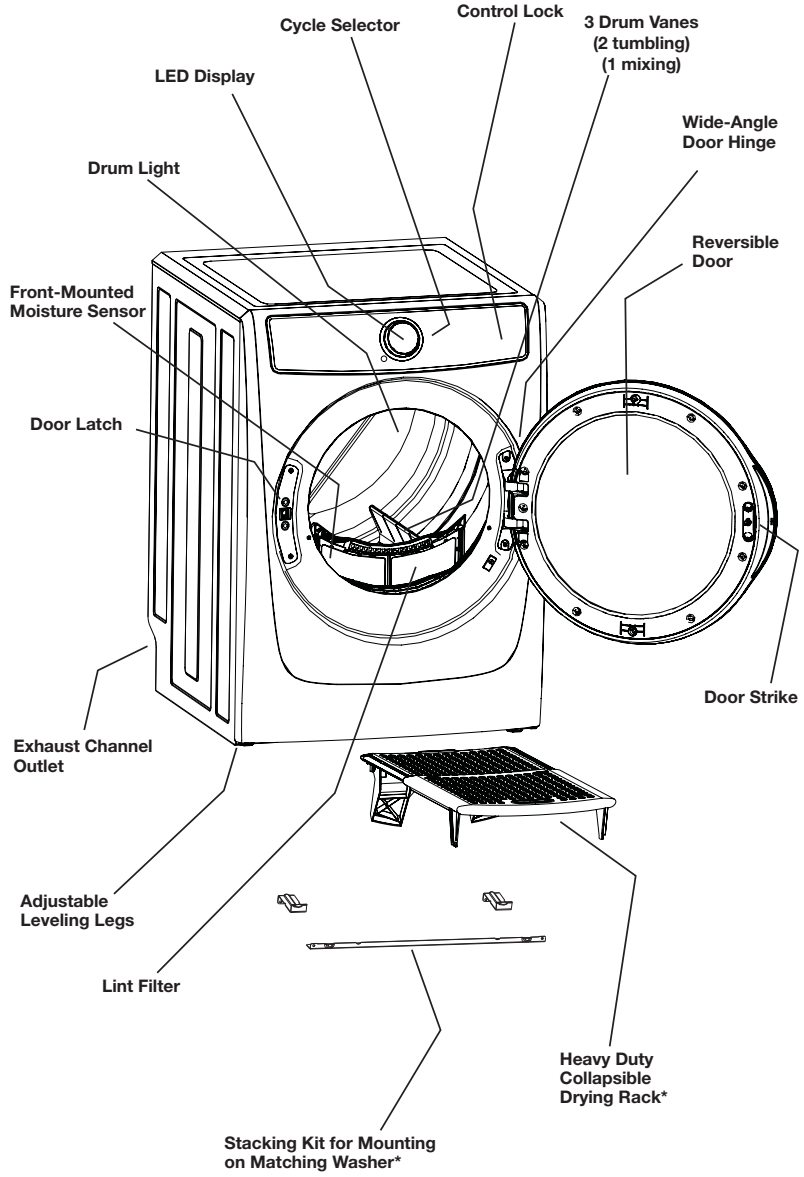

*Not all models come with drying rack and stacking kit from the factory. They may be purchased as accessories.

Normal Operating Sounds

You may or may not hear the following sounds from your new dryer:

- A. WATER VALVE** (Steam models only.) The flow of water is controlled by electric solenoids. During operation there may be a clicking sound as the valve opens and closes to control the water flow.
- B. SUSPENSION ROLLERS** The dryer drum is supported by a set of suspension rollers. At times there may be a thumping or rolling sound when the dryer starts. This may happen if the dryer has not been in use for a period of time, or after a heavy load has remained in the dryer drum for an extended period, creating a temporary flat spot on the edge of the roller. The noise should dissipate as the dryer operates and the flat spots smooth out.
- C. AIR FLOW SYSTEM** Your dryer is equipped with a high volume air handling system. In some installations there may be some sounds associated with air movement throughout the dryer, including the air duct, blower, and exhaust system. This is normal and can vary with load size and type.
- D. GAS VALVE** (Gas models only.) The flow of gas is controlled by electric solenoids. During operation there may be a clicking sound as the valve opens and closes to control the gas flow.
- E. GAS BURNER** (Gas models only.) When the burner is operating, there may be sounds generated as the air flow mixes with the gas flame. This noise is normal and will only occur when the gas is ignited in the combustion tube.

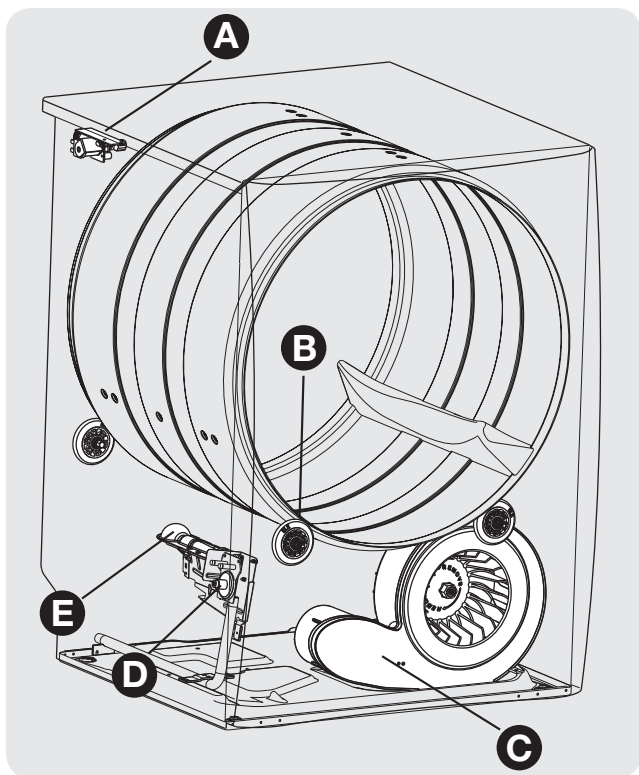

8 Operating Instructions

Before Operating Your Dryer

Read the important instructions in this section of the *Use and Care Guide* before operating your dryer.

IMPORTANT

Prior to using the **sanitize** feature (if available) on your dryer for the first time, internal dryer parts must be conditioned to ensure a complete sanitization of your laundry.

1. Place a wet load of towels or other durable fabrics suitable for high temperatures into the dryer.
2. Set the dryer for the **75 minute time dry** cycle and adjust the temperature to **sanitize**.
3. Once the cycle is complete, remove the load.

Your dryer is now conditioned and ready to sanitize your laundry. It is not necessary to repeat internal dryer part conditioning.

WARNING

To reduce the risk of fire, electric shock or injury to persons, read the IMPORTANT SAFETY INSTRUCTIONS in this *Use and Care Guide* before operating your dryer.

Operating Your Dryer

1. Prepare load for drying.

- Dry items of similar fabric, weight and construction in the same load.
- Separate dark items from light-colored items. Separate items that shed lint from those that attract lint.
- Check for stains which may not have been removed in washing. Repeat stain removal process and wash again before drying. Dryer heat may permanently set some stains.
- Place delicate or small items in a mesh bag.

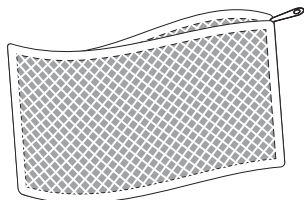

(Mesh bag not included.)

- Be sure buckles, buttons and trim are heat-proof and won't damage the drum finish. Close zippers; fasten hooks and Velcro®-like fasteners. Tie strings and sashes to prevent snagging and tangling.

2. Check that the lint filter is clean and in place.

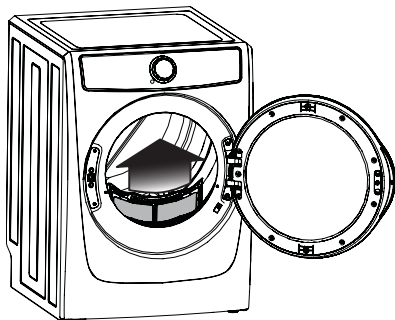

CAUTION

Do not operate dryer without lint filter in place.

3. Load the dryer and close the door.

- Load items loosely. The average wet load will fill the drum 1/3 to 1/2 full. Items need room to tumble freely for even drying and less wrinkling.
- If desired, place a dryer fabric softener sheet on top of the load at the beginning of the cycle.
- To save energy and time and avoid uneven drying and wrinkling, do not overload the dryer.
- When drying large items, dry only two or three items at a time. Fill out the load with small and medium sized items.
- For delicate or very small loads, add two or three larger items to improve tumbling action.

4. Select the appropriate cycle and settings for each load.

NOTE

Over-drying can cause wrinkles, shrinkage, lint, harshness and a build up of static electricity.

- Press the **power**  button turn to on the unit.
- Turn the cycle selector ring (on some models) in either direction or repeatedly press the cycles button (on other models) to scroll to the desired cycle. The indicator for that cycle will be illuminated. See the “Cycle Selection” section in this guide for descriptions of each cycle.
- The estimated drying time for Auto Dry cycles or the actual drying time for Time Dry cycles will be displayed.
- A suitable drying temperature, dryness level and options will automatically be indicated for the cycle selected. See the “Dryer Settings Chart” for more details.
- To change the drying temperature, dryness level, or drying time press the **temp**, **dry level** or **dry time** buttons to scroll to the desired settings.

NOTE

If a setting is not available for the cycle selected, the indicator will not light.

- Adjustments made to cycle settings will be remembered and recalled each time that cycle is selected in the future.

NOTE

To prevent unintentional and accidental exposure of delicate material to excess heat or unexpected steam, the **sanitize** temperature setting and the **perfect steam™** option will not be remembered and must be reselected each time.

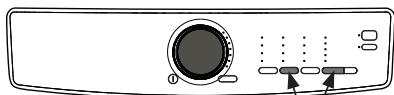

To return to factory settings, press **power** and look for console light up, wait at least 10 seconds, then press the **dry level** and **options** buttons at the same time and hold until the signal sounds.

- To select or delete an option, press **options**; then, while the indicator is blinking, press **set**. The indicator will light when the option has been selected. It will no longer be lighted when the option has been deleted.

5. Start the cycle.

- Close the door and press **start**. The dryer will not operate with the door open.
- Select **delay start** to delay the beginning of the cycle, if desired.
- To add a forgotten item to the dryer drum, press **pause** and open the door. Opening the door with a cycle running will also pause the cycle. Add the item, close the door and press **start** to resume the cycle.
- To change the settings or options after the cycle starts, press **pause**, make the new selections and press **start** again.
- To change the cycle once the cycle has begun, press **cancel** to stop the current cycle, select a new cycle, and press **start** again. Just turning the cycle selector ring or pressing the cycles button will not change the cycle.
- A signal will sound at the end of the cycle if the chime option has been selected.

NOTE

If drying a single large or bulky item remove the item part way through the cycle and turn it “inside out” to maximize drying effectiveness. Place item back in dryer and re-start cycle.

6. When the cycle ends, remove items immediately and hang or fold.

IMPORTANT

Clean the lint filter after every load. **CLEAN LINT** will be displayed at the end of the cycle to remind you to remove lint from the filter.

10 Operating Instructions

Cycle Selection

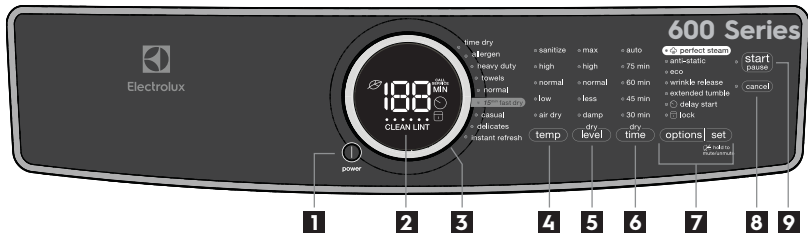
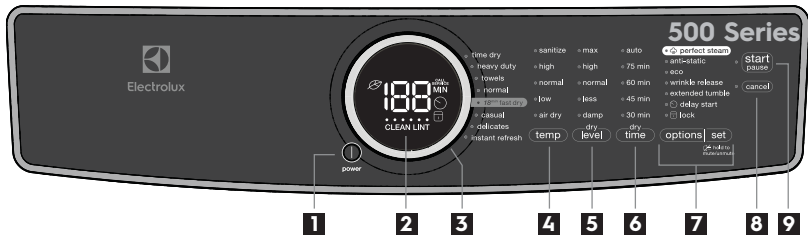
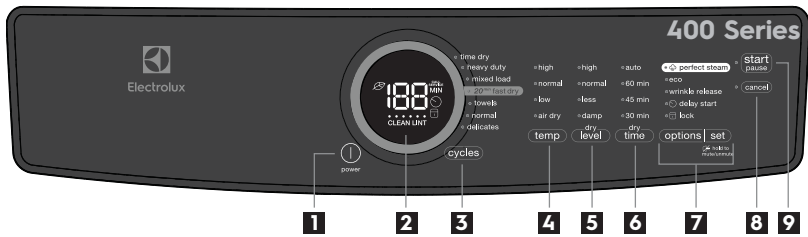

- | | | |
|----------------------|-------------------------------|-------------------------|
| 1 power | 2 cycle status display | 3 cycle selector |
| 4 temperature | 5 dryness level | 6 drying time |
| 7 options/set | 8 cancel | 9 start/pause |

This manual covers many models and not all cycles, options, or features listed are available on every model. Consoles shown above for reference only. Your model may differ.

SELECTING THE RIGHT CYCLE TO SAVE ENERGY

This dryer has been specifically designed with options to help you save energy and at the same time utilize the optimal drying setting for your clothing.

The **normal** cycle was used to rate the dryer for energy efficiency. The **normal** cycle defaults to **normal** temperature setting, **normal** dryness level and **eco mode** option on.

Some cycles save more energy than others. Cycles that use the least amount of heat save the most energy. Use the lowest heat setting (auto and timed dry cycles) and less dry setting (auto dry cycles) to save on energy and prevent over drying your clothing.

For best results

Follow the fabric care label instructions on items to be dried.



Press the **power** (1) button to turn on the unit. Turn the cycle selector ring (on select models) in either direction or repeatedly press the cycles button (on other models) to scroll through the cycles.

To change the cycle once it has begun, press the **cancel** button before selecting a new cycle. Just turning the cycle selector ring or pressing the cycles button will not change the cycle.

Auto Dry Cycles

Auto Dry cycles take the guesswork out of selecting the correct drying time for each load. Moisture sensing bars in the front of the dryer drum sense the moisture level of the load as it tumbles through the heated air. With Auto Dry cycles, the load will automatically be dried at the selected temperature to the desired dryness level.

Auto Dry cycles save time and energy and protect fabrics. When the load has reached the selected dryness level, it will continue to tumble, unheated, during a cool down period. This helps reduce wrinkling and makes items easier to handle during unloading.

NOTE

Initial cycle times for Auto Dry Cycles are only estimates. Actual drying time may be longer or shorter than displayed time.

Drying time varies depending on size and dampness of load and fabric type. If the load is too small or almost dry, the moisture sensing bars may not detect enough moisture to continue the cycle and the cycle may end after a few minutes. If this occurs, then select the **time dry** cycle to dry such loads.

Room temperature and humidity, type of installation and electrical voltage or gas pressure can also affect drying time.

normal

Select this cycle to dry everyday fabrics including cottons, linens and sheets.

towels

Select this cycle to dry heavy loads such as towels and non-rubber-backed bath mats.

mixed load (on select models)

Select this cycle to dry loads containing a mix of fabrics.

heavy duty

Select this cycle to dry durable fabrics such as jeans and overalls.

allergen (on select models)

Select this cycle where you wish to reduce allergens as you dry your load. Items prone to heat damage are not recommended for this cycle.

casual (on select models)

Select this cycle to dry cottons, blends and permanent press items with a no-iron finish.

delicates

Select this cycle to dry knits and delicates.

Time Dry Cycles

time dry

To manually select the drying time for any load, scroll the cycle selector indicator to **time dry**. Drying times from **30 to 60 minutes** or **75 minutes** (on select models) can be selected by pressing the **dry time** button. Drying time will be displayed. Select any drying temperature. Because this is not an Auto Dry cycle, you will not be able to select a dryness level.

WARNING

FIRE HAZARD

To avoid fire hazard, do not use heat to dry items containing feathers or down, foam rubber, plastics similarly textured, rubber-like materials. Use the **time dry** cycle and the **air dry** (no heat) setting.

20^{min} fast dry (400 series model)

Select this cycle to quickly dry small loads in 20 minutes.

18^{min} fast dry (500 series model)

Select this cycle to quickly dry small loads in 18 minutes.

15^{min} fast dry (600 series model)

Select this cycle to quickly dry small loads in 15 minutes.

instant refresh

Select this cycle to refresh fabrics, remove odors and reduce static by injecting the perfect amount of steam into clothing that has been left in the dryer, stored in crowded closets, drawers, or unpacked luggage.

NOTE

It is not recommended to use fabric softener sheets with steam cycles or steam options as it may cause staining on clothes.

Cycle Settings

Drying Temperature

To change the temperature, press the **temp** button to scroll to the desired setting.

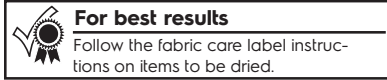

To protect your fabrics, not all temperatures are available with every cycle. If a temperature is not appropriate for the cycle, it cannot be selected and will not be lit by pressing the **temp** button.

With exception of **sanitize**, the temperature selected for the cycle will be remembered and recalled each time that cycle is selected in the future.

NOTE

To change the temperature once the cycle has begun, press the **pause** button, make the new selection and press **start** again.

sanitize (on select models)

Recommended for durable fabrics and towels. Use this selection to remove harmful bacteria from your clothing or other items where sanitization is desired.

This option will kill 99.9% of bacteria. A higher temperature is required to kill bacteria. Please check fabric care labels to prevent damage.

high

Recommended for most cotton fabrics.

normal

Recommended for wrinkle free, easy care, lightweight fabrics and bulky loads.

low

Recommended for delicate fabrics.

air dry

This setting (no heat) should only be used with a time dry cycle to dry items containing feathers, down, foam rubber, plastics or rubber-like materials; to refresh clothing, stuffed animal, pillows or blankets; and to dust draperies.

Dryness Level (Auto Dry)

The appropriate dryness level will automatically be indicated when an auto dry cycle is selected. To change the preset level, press the **dry level** button to scroll to the degree of dryness desired.

To protect your fabrics, not all dryness levels are available with every cycle. If a dryness level is not appropriate for the cycle, it cannot be selected and will not be lit by pressing the **dry level** button.

The dryness level selected for the cycle will be remembered and recalled each time that cycle is selected in the future.

NOTE

To change the dryness level once the cycle has begun, press the **pause** button, make the new selection and press **start** again.

Select the **normal** dryness level for most Auto Dry cycles.

Occasionally a load may seem too damp or over-dried at the end of the cycle. To increase drying time for similar loads in the future, select **high** or **max** (on select models). For loads requiring less drying time, select **less**.

Select **damp** for items you wish to partially dry before hanging or ironing.

Cycle Options

To add an option, press **options** until the indicator for the desired option flashes, then press **set**. The indicator will be illuminated when the option has been selected. Follow the same steps to delete an option.

To protect your fabrics, not all options are available with every cycle. If an option is not available for a cycle, the indicator will not light.

Occasionally, two options or settings in the same cycle will conflict with each other, like **eco** option and **sanitize** temperature (on select models). When this happens, the option selected first will cause the conflicting option to not be selectable.

NOTE

To change the options once the cycle has begun, press the **pause** button, make the new selections and press **start** again.

extended tumble (on select models)

Select the **extended tumble** option if the dried load might not be removed promptly at the end of the cycle. The dried load will tumble continuously without heat for 30 minutes. A chime will sound periodically to remind you to remove the dried load.

The **wrinkle release** option can be selected with **extended tumble** to increase the amount of time the load will tumble without heat up to 75 minutes.

⏸ delay start

Use ⏸ **delay start** to select a drying time convenient to your schedule or during off-peak energy hours. The start of any cycle can be delayed for 30 minutes to 12 hours. Scroll through the options to select the ⏸ **delay start** option, press **set** and then to scroll to the delayed desired time setting with the cycle selector. After choosing the desired delay time, press **start** and the delay time will begin counting down.

NOTE

While counting down during **delay start**, you will notice your dryer periodically tumbling for a few minutes without heat to redistribute the load, maximizing load freshness.

🌀 perfect steam™

The 🌀 **perfect steam™** option injects steam into the clothing prior to cool down to reduce wrinkling, ironing and static cling.

NOTE

It is not recommended to use fabric softener sheets with steam cycles or steam options as it may cause staining on clothes.

anti-static (on select models)

The **anti-static** option injects steam into the clothing just before cycle completion to reduce static.

wrinkle release

The **wrinkle release** option helps prevent wrinkles and tangling by tumbling the dry load without heat for 5 minutes out of every 10 minutes. The 5 minutes on and 5 minutes off is repeated for a total 45 minutes. A chime will sound after every 5 minute tumble to remind you to remove the dried load.

The **extended tumble** (if available) option can be selected with **wrinkle release** to increase the amount of time the load will tumble without heat for up to 75 minutes.

🔒 lock

To lock the controls between cycles, scroll to the 🔒 **lock** option and press **set**. "🔒" will be displayed on the panel. To unlock the controls scroll to the 🔒 **lock** option and press **set**. Use this feature to reduce the likelihood of accidental operation by children.

eco

The **eco** option reduces the drying temperature a few degrees to save energy. In conjunction with automatic moisture sensors, cycle times will increase slightly, but overall energy usage will decrease. The ♻ symbol will be shown on the center display to indicate the **eco** option is activated.

Other Features

Chime (press & hold set button)

A signal will sound at the end of the cycle and periodically during **extended tumble** or **wrinkle release** if this option is activated.



 hold to mute/unmute

Muting the end of cycle signal will not mute the button tones.

Status Display

The estimated cycle time for **auto dry** and the actual time for **time dry** will be displayed when the cycle is selected. The estimated remaining cycle time is displayed during the cycle. As the dryer progresses through the cycle phases, the row of cycle phase indicators lights up under the cycle time.



Drum Light

The drum light will come on whenever the door is opened to illuminate the drum during loading and unloading. Closing the door turns off the light. The drum light will automatically turn off if the door is left open more than 3 minutes.

Reversible Door

Your dryer is equipped with a reversible door. The door can be hinged on the right or left side.

NOTE

For step-by-step instructions on door reversal, refer to the *Installation Instructions* supplied with this dryer.

Drying Rack (on select models)

Use the drying rack for items which should not be tumble dried. Extend the collapsed drying rack and insert the rack into the dryer drum. Place the front legs into the front air grill and lower the rear of the rack onto the back of the dryer drum.

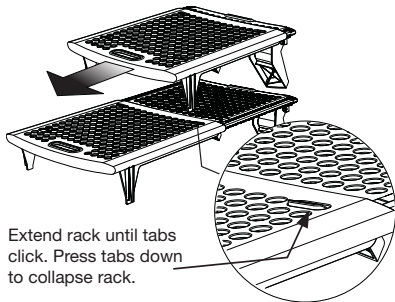

Extend rack until tabs click. Press tabs down to collapse rack.

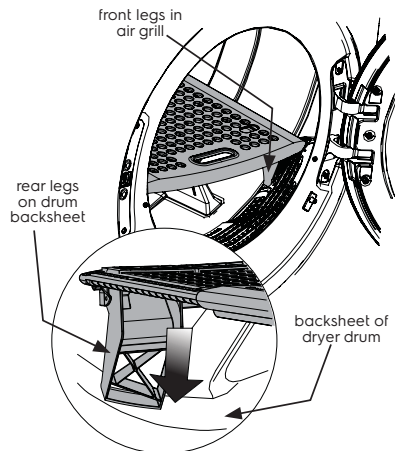

Place items to be dried on top of the rack, leaving space between items and not allowing them to hang over the sides or through the holes. The weight should not exceed 10 lbs (4.5 kg).

NOTE

The drying rack accessory should only be used with **time dry cycles**. Use of rack with **auto dry cycles** will result in a shortened cycle with unwanted drying results.

Select the air dry setting for items containing plastic, foam rubber, rubber-like materials, feathers or down. When items are dry, remove the rack and store it in a convenient location.

NOTE

If your model did not come supplied from the factory with a drying rack you may order one.

Setting Chart - 400 Series Dryer

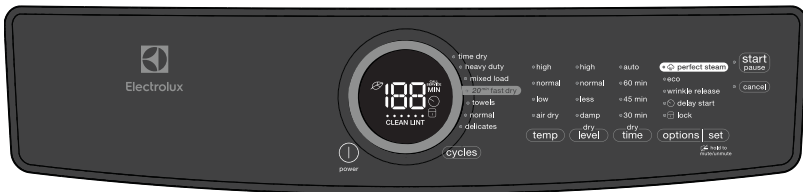

These temperature, dryness levels and options are available with the following cycles:

	time dry (30-60)	heavy duty	mixed load	20 ^{min} fast dry	towels	normal	delicates
--	------------------	------------	------------	----------------------------	--------	--------	-----------

temp

high	✓	✓		✓	✓		
normal	✓	✓	✓		✓	✓	
low	✓					✓	✓
air dry	✓						

dry level

high		✓	✓		✓	✓	
normal			✓		✓	✓	✓
less						✓	✓
damp						✓	✓

options

perfect steam™			✓			✓	✓
eco		✓	✓		✓	✓	✓
wrinkle release	✓	✓	✓			✓	✓
delay start	✓	✓	✓	✓	✓	✓	✓
lock	✓	✓	✓	✓	✓	✓	✓
press & hold chime	✓	✓	✓	✓	✓	✓	✓

✓ = Available selections. = Factory presets. = Non-modifiable presets.

16 Operating Instructions

Setting Chart - 500 Series Dryer

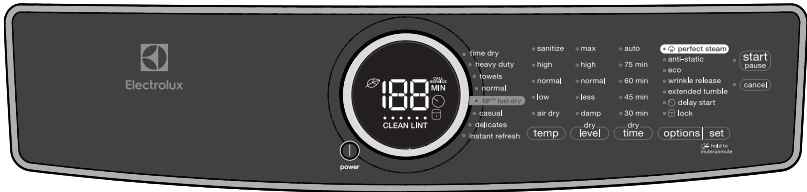

These temperature, dryness levels and options are available with the following cycles:

	time dry (30-75)	heavy duty	towels	normal	18 ^{min} fast dry	casual	delicates	instant refresh
--	------------------	------------	--------	--------	----------------------------	--------	-----------	-----------------

temp

sanitize	✓	✓	✓					
high	✓	✓	✓		✓	✓		✓
normal	✓	✓	✓	✓		✓		
low	✓			✓		✓	✓	
air dry	✓							

dry level

max		✓	✓	✓				
high		✓	✓	✓		✓		
normal			✓	✓		✓	✓	
less				✓		✓	✓	
damp				✓		✓	✓	

options

perfect steam™				✓		✓	✓	✓
anti-static		✓		✓		✓	✓	
eco		✓	✓	✓		✓	✓	
wrinkle release	✓	✓		✓		✓	✓	
extended tumble	✓	✓	✓	✓	✓	✓	✓	
delay start	✓	✓	✓	✓	✓	✓	✓	✓
lock	✓	✓	✓	✓	✓	✓	✓	✓
press & hold chime	✓	✓	✓	✓	✓	✓	✓	✓

✓ = Available selections. ◻ = Factory presets. ◼ = Non-modifiable presets.

Setting Chart - 600 Series Dryer

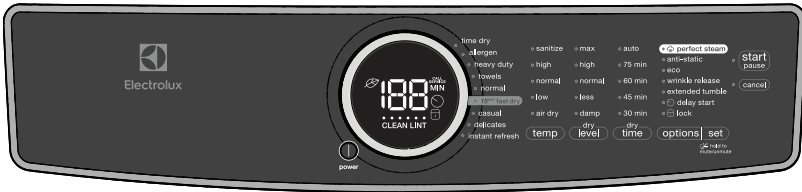

These temperature, dryness levels and options are available with the following cycles:

	time dry (30-75)	allergen	heavy duty	towels	normal	15 ^{min} fast dry	casual	delicates	instant refresh
--	------------------	----------	------------	--------	--------	----------------------------	--------	-----------	-----------------

temp

sanitize	✓		✓	✓					
high	✓	✓	✓	✓		✓	✓		✓
normal	✓		✓	✓	✓		✓		
low	✓				✓		✓	✓	
air dry	✓								

dry level

max		✓	✓	✓	✓				
high			✓	✓	✓		✓		
normal				✓	✓		✓	✓	
less					✓		✓	✓	
damp					✓		✓	✓	

options

perfect steam™					✓		✓	✓	✓
anti-static			✓		✓		✓	✓	
eco			✓	✓	✓		✓	✓	
wrinkle release	✓		✓		✓		✓	✓	
extended tumble	✓	✓	✓	✓	✓	✓	✓	✓	
delay start	✓	✓	✓	✓	✓	✓	✓	✓	✓
lock	✓	✓	✓	✓	✓	✓	✓	✓	✓
press & hold chime	✓	✓	✓	✓	✓	✓	✓	✓	✓

✓ = Available selections. ◻ = Factory presets. ◼ = Non-modifiable presets.

⚠ WARNING

To reduce risk of fire or serious injury to persons or property, comply with the basic warnings listed in the Important Safety Instructions and those listed below.

- Before cleaning the dryer drum interior, unplug the electrical power cord to avoid electrical shock hazards.
- Do not use any type spray cleanser when cleaning the dryer interior. Hazardous fumes or electrical shock could occur.

Inside

- Clean the lint filter after every load. Lint build-up on the filter restricts air flow, which causes longer drying times. The filter is located at the bottom of the door opening. Remove by pulling straight up. Remove the lint and replace the filter.
- Occasionally a waxy build-up may form on the lint filter and/or moisture sensing bars from using dryer-added fabric softener sheets. To remove this build-up, wash them with warm, soapy water. Dry the filter thoroughly and replace. Do not operate the dryer without the lint filter in place.
- If the dryer drum becomes stained from non-colorfast fabrics, clean the drum with a damp cloth and a mild liquid household cleanser. Remove cleanser residue before drying the next load.
- Every 18 months a qualified servicer should clean the dryer cabinet interior, lint screen housing and exhaust duct. These areas can collect lint and dust over time. An excessive amount of lint build-up could result in inefficient drying and possible fire hazard.

Outside

- Clean the cabinet with mild soap and water. Never use harsh, gritty or abrasive cleansers.
- If the cabinet becomes stained, clean with diluted chlorine bleach (1 part bleach to 8 parts water). Rinse several times with clear water.
- Remove glue residue from tape or labels with a mixture of warm water and mild detergent. Or, touch residue with the sticky side of the tape or label.
- When cleaning chrome parts, it is best to use only a damp cloth.
- Before moving the dryer, place a strip of cardboard or thin fiberboard under the front leveling legs to prevent damage to the floor.

⚠ WARNING**FIRE HAZARD**

A clothes dryer produces combustible lint. The dryer must be connected to an outdoors exhaust. Regularly inspect the outdoor exhaust opening and remove any accumulation of lint around the opening and in the surrounding area.

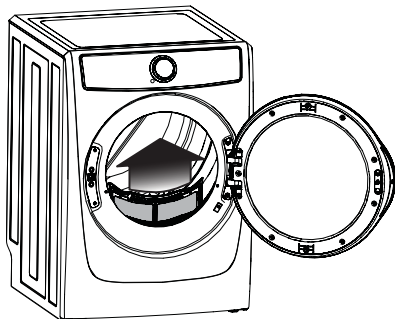
**📌 IMPORTANT**

Clean lint screen after every load.

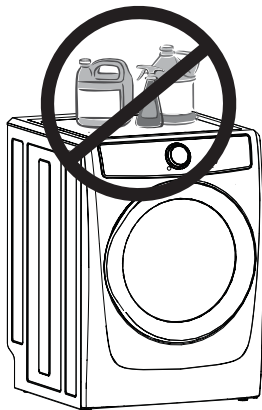
**📌 IMPORTANT**

Do not store or place laundry products on top of dryer at any time. They can damage the finish or controls. It is recommended to keep laundry products in the storage drawer between cycles if installed on a pedestal.

Common Drying Inquiries

Many drying problems involve poor cleaning results, poor soil and stain removal, residues of lint and scum, and fabric damage. For satisfactory drying results, follow these suggestions provided by The Soap and Detergent Association.

PROBLEM	POSSIBLE CAUSES	SOLUTIONS	PREVENTIVE MEASURES
Greasy, oily stains	<ul style="list-style-type: none"> • Fabric softener sheet 	<ul style="list-style-type: none"> • Rub fabric softener stains with bar soap. Rinse and rewash. 	<ul style="list-style-type: none"> • Add a few bath towels to small loads for proper tumbling. • Some "silk-like" fabrics should be air dried. • Use proper drying temperature. • Place fabric softener sheet on top of load before starting the dryer.
Lint	<ul style="list-style-type: none"> • Overloading. • Overdrying causes static electricity. • Lint screen not clean when cycle began. • Lint is attached to "pills." 	<ul style="list-style-type: none"> • Reduce load size and rewash using liquid fabric softener in the final rinse. • Or, add a fabric softener sheet and tumble without heat • Use lint brush or roller to remove lint 	<ul style="list-style-type: none"> • Do not overload dryer. • Use fabric softener in washer or dryer to reduce static electricity. • Remove items when they are slightly damp to avoid overdrying. • Check that lint filter is clean and in place.
Pilling (Fibers break off, ball up and cling to fabric.)	<ul style="list-style-type: none"> • Overdrying. 	<ul style="list-style-type: none"> • Use a lint brush or shaver to remove pills. 	<ul style="list-style-type: none"> • Use fabric softener to lubricate fibers. • When ironing, use spray starch or fabric finish on collars and cuffs. • Turn items inside out to reduce abrasion.
Shrinking	<ul style="list-style-type: none"> • Temperature too high. • Overdrying. 	<ul style="list-style-type: none"> • Irreversible condition. 	<ul style="list-style-type: none"> • Follow fabric care label directions. • If shrinking is a concern, check load often. • Remove items while slightly damp and hang or lay flat to complete drying. • Block knits into shape.
Wrinkling	<ul style="list-style-type: none"> • Overloading. • Leaving items in dryer after cycle ends. 	<ul style="list-style-type: none"> • Reduce load size and tumble at medium or low heat for 5-10 minutes. • Remove items immediately. Hang or fold. 	<ul style="list-style-type: none"> • Do not overload dryer. • Remove items as soon as cycle ends.
Isolated wet spots on fabrics after completed Steam cycle	<ul style="list-style-type: none"> • Low water line pressure in home is not sufficient to atomize incoming water during Steam cycle 	<ul style="list-style-type: none"> • Check water line pressure 	<ul style="list-style-type: none"> • Ensure water line pressure is minimum of 30 psi. Do not exceed 120 psi.

Service Prevention Checklist

Before calling for service, review this list. It may save both time and expense. The list includes common occurrences that are not the result of defective workmanship or materials in this dryer.

OCCURRENCE	POSSIBLE CAUSE	SOLUTION
Dryer does not start	Electrical power cord is not securely plugged in or plug may be loose.	Make sure the plug fits tightly in wall outlet.
	House fuse blown or circuit breaker tripped.	Reset circuit breaker or replace fuse. Make sure electrical line is not overloaded and the dryer is on a separate circuit.
	Action of pressing start button on "touch screen" style console not recognized	Press start button with bare fingertip.
	Thermal limiter tripped.	Call authorized service person for replacement.
	Delay Start inadvertently activated	Ensure Delay Start not activated.
	Door may be open. Unit will not operate with door open.	Ensure door is closed.
LED displays 'dn'.	Dryer has been programmed to temporarily perform a repeating demo cycle.	Reset the unit back to factory default settings as described earlier.
Dryer runs but won't heat	There are 2 house fuses in the dryer circuit. If 1 of the 2 fuses is blown, the drum may turn but the heater will not operate. (electric models)	Replace fuse.
	Gas supply valve is not open (gas models).	Check to make sure supply valve is open. See INSTALLATION INSTRUCTIONS for procedure.
	Dryer does not have enough air supply to support the burner flame (gas models).	See INSTALLATION INSTRUCTIONS.
	LP gas supply tank is empty or there has been a utility interruption of natural gas (gas models).	Refill or replace tank. Dryer should heat when utility service is restored.

Drying cycle takes too long, outside of the dryer feels too hot or smells hot	Lint filter is clogged with lint	Make sure all lint has been removed from the dryer lint filter before starting each cycle.
	Exhaust duct requirements have not been met	Exhaust duct must be at least 4 inches in diameter and made of rigid or semi-rigid metal. When in place, the duct must have no more than four 90° bends and must not exceed length listed in INSTALLATION INSTRUCTIONS.
	Electric dryer is connected to a 208 volt circuit	Drying time will be 20% longer than drying on a 240 volt circuit.
	Drying procedures have not been followed.	See "Operating Instructions."
	Outside exhaust hood or exhaust duct may be clogged or restricted.	Clean out any obstruction.
Excess moisture in drum between cycles	High humidity.	Use a dehumidifier near the dryer.
	Exhaust damper stuck open or not present.	Fix or clean the damper, or install new one.
	Excessive wrinkling.	
Excessive wrinkling.	Dryer is overloaded.	Do not overload. See "Operating Instructions."
	Items left in dryer too long.	Remove items as soon as cycle ends.
	Insufficient sorting of items.	See "Operating Instructions."
Scratching or chipping of the drum finish.	Drying temperature too high.	Follow fabric care label instructions.
	Foreign objects such as coins, pins, clips or buttons are inside the dryer.*	Always remove foreign objects from pockets before laundering. Remove objects from drum and restart dryer.
	Permanently attached items such as belt buckles, zippers and fasteners may be hitting the inside of the drum.*	It may be necessary to sew a scrap of material securely around ornaments before drying to prevent scratching and damage to the dryer.

*Drum damage caused by foreign objects or permanently attached items is not covered by the warranty.

For the applicable warranty period as set forth below, as measured from your original date of purchase, Electrolux will repair or replace any parts of this appliance that prove to be defective in materials or workmanship when such appliance is installed, used and maintained in accordance with the provided instructions.

Warranty Periods:

- All parts – One year including labor. In addition, your appliance is covered by a one year, parts only, limited warranty. During the 2nd year from your original date of purchase, Electrolux will pay for parts needed for this appliance that have proven to be defective in materials or workmanship when your appliance is installed, used, and maintained in accordance with the provided instructions.
- Inner wash tub (washer) – Functional life of the product (excluding labor)
- Wash tub drive motor (washer), non-cosmetic defects – Ten years (excluding labor)

Exclusions

This warranty does not cover the following:

1. Products with original serial numbers that have been removed, altered or cannot be readily determined.
2. Product that has been transferred from its original owner to another party or removed outside the USA or Canada.
3. Rust on the interior or exterior of the unit
4. Products purchased "as-is" are not covered by this warranty.
5. Products used in a commercial setting.
6. Service calls which do not involve malfunction or defects in materials or workmanship, or for appliances not in ordinary household use or used other than in accordance with the provided instructions.
7. Service calls to correct the installation of your appliance or to instruct you how to use your appliance.
8. Expenses for making the appliance accessible for servicing, such as removal of trim, cupboards, shelves, etc., which are not a part of the appliance when it is shipped from the factory.
9. Service calls to repair or replace appliance light bulbs, air filters, water filters, other consumables, or knobs, handles, or other cosmetic parts.
10. Pickup and delivery costs; your appliance is designed to be repaired in the home.
11. Surcharges including, but not limited to, any after hour, weekend, or holiday service calls, tolls, ferry trip charges, or mileage expense for service calls to remote areas, including the state of Alaska.
12. Damages to the finish of appliance or home incurred during transportation or installation, including but not limited to floors, cabinets, walls, etc.
13. Damages caused by: services performed by unauthorized service companies; use of parts other than genuine Electrolux parts or parts obtained from persons other than authorized service companies; or external causes such as abuse, misuse, inadequate power supply, accidents, fires, or acts of God.

DISCLAIMER OF IMPLIED WARRANTIES; LIMITATION OF REMEDIES

CUSTOMER'S SOLE AND EXCLUSIVE REMEDY UNDER THIS LIMITED WARRANTY SHALL BE REPAIR OR REPLACEMENT AS PROVIDED HEREIN. **CLAIMS BASED ON IMPLIED WARRANTIES, INCLUDING WARRANTIES OF MERCHANTABILITY OR FITNESS FOR A PARTICULAR PURPOSE, ARE LIMITED TO ONE YEAR OR THE SHORTEST PERIOD ALLOWED BY LAW, BUT NOT LESS THAN ONE YEAR.** ELECTROLUX SHALL NOT BE LIABLE FOR CONSEQUENTIAL OR INCIDENTAL DAMAGES SUCH AS PROPERTY DAMAGE AND INCIDENTAL EXPENSES RESULTING FROM ANY BREACH OF THIS WRITTEN LIMITED WARRANTY OR ANY IMPLIED WARRANTY. SOME STATES AND PROVINCES DO NOT ALLOW THE EXCLUSION OR LIMITATION OF INCIDENTAL OR CONSEQUENTIAL DAMAGES, OR LIMITATIONS ON THE DURATION OF IMPLIED WARRANTIES, SO THESE LIMITATIONS OR EXCLUSIONS MAY NOT APPLY TO YOU. THIS WRITTEN WARRANTY GIVES YOU SPECIFIC LEGAL RIGHTS. YOU MAY ALSO HAVE OTHER RIGHTS THAT VARY FROM STATE TO STATE.

If You Need Service

Keep your receipt, delivery slip, or some other appropriate payment record to establish the warranty period should service be required. If service is performed, it is in your best interest to obtain and keep all receipts. Service under this warranty must be obtained by contacting Electrolux at the addresses or phone numbers below.

This warranty only applies in the USA, Puerto Rico and Canada. In the USA and Puerto Rico, your appliance is warranted by Electrolux Major Appliances North America, a division of Electrolux Home Products, Inc. In Canada, your appliance is warranted by Electrolux Canada Corp. Electrolux authorizes no person to change or add to any obligations under this warranty. Obligations for service and parts under this warranty must be performed by Electrolux or an authorized service company. Product features or specifications as described or illustrated are subject to change without notice.

USA

1-877-435-3287

Electrolux Home Products, Inc.,
North America
10200 David Taylor Drive
Charlotte, NC 28262



Electrolux

Canada

1-800-265-8352

Electrolux Canada Corp.
5855 Terry Fox Way
Mississauga, Ontario, Canada
LSV 3E4

electrolux.com/shop

