

ZIP HydroTap® G4 User Guide

- Tap Operation.....(Pages 2-10)
- LCD Screen & Menu(Pages 11-22)
- Maintenance..... (Pages 23-26)
- Home Menu Icons.....(Page 27)
- Contact details.....(Page 28)

Date of Installation...../...../.....

BCS Commercial



**Affix Model Number Label
Here
801912**



Tap Safety

The safety lock feature is provided to prevent boiling water flowing if the hot lever is inadvertently operated.

This function can be activated and deactivated from either the Tap or from the touch screen display (Located on the unit in the cupboard).

To set the tap safety setting: (Classic; Elite & All-In-One taps)

1. Press [MENU] button for main menu.
2. Press [Setting] button.
3. Press [Safety] button.
4. Press button (A) YES / NO to allow or disallow the safety setting to be changed on the tap.

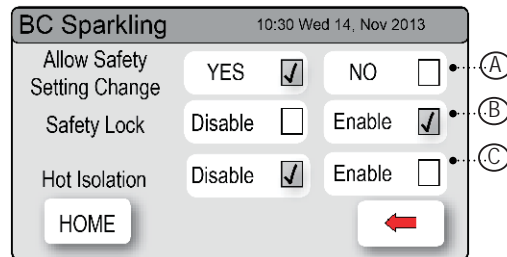

Note: The Factory setting is set at YES

To activate the safety for Classic, Elite & AIO (From the tap):

After selecting to allow the safety setting from the menu screen. Place a finger on the safety lock, then depress the Classic Blue/Chilled lever or touch the Elite Blue/Chilled Button, while keeping both fingers in position for more than ten seconds. The Classic safety lock indicator light will now be illuminated or the Elite lights will flash, momentarily.

HydroTap Classic

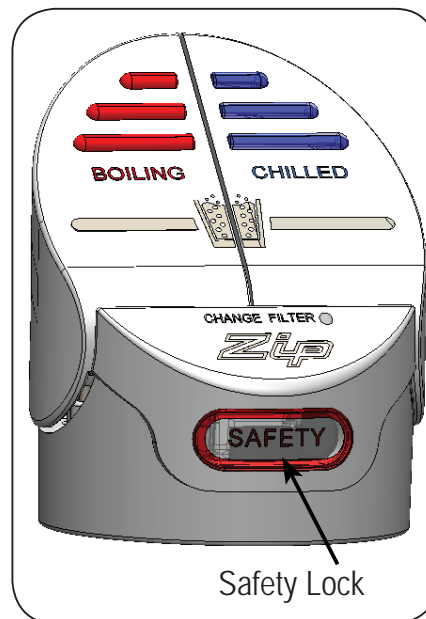

To deactivate the safety (From the tap):

First place a finger on the safety lock, then depress the Classic Blue/Chilled lever or touch the Elite Blue/Chilled Button, while keeping both fingers in position for more than ten seconds. The Classic safety lock indicator light will now extinguish or the Elite lights will flash, momentarily.

To control the safety (From the touch screen):

(See page 22)

For Hot Isolation:

Not for HydroTap Arc/Cube, (see page 22)



Elite Tap

Tap functions

Elite Tap:

The Elite tap uses touch sensitive controls, to dispense Boiling, Chilled and Sparkling water.

When operating the tap, ensure the touch surface is dry as moisture may interfere with the sensor touch control.

The safety lock can be controlled from either the tap or from the touch screen display in the same way as the Classic tap (See page 2)

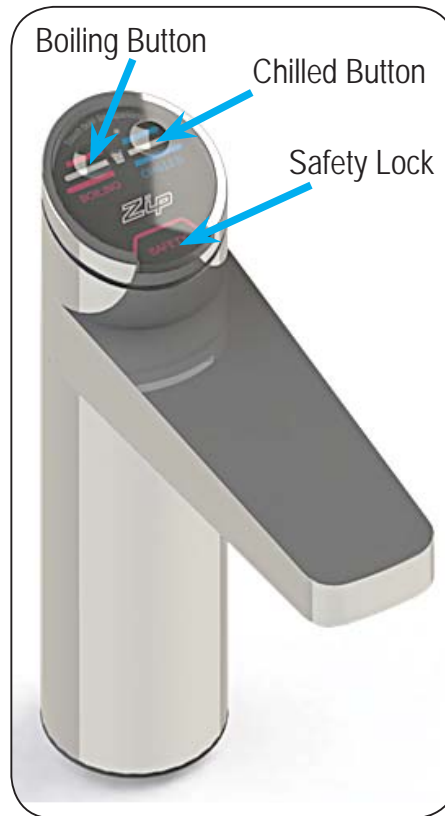

All-In-One Tap:

The top of the All-In-One tap is operated the same as a Classic HydroTap. The two levers are used for dispensing Boiling, Chilled and Sparkling water. The safety button operating in the same way as on the HydroTap.

The Mixer tap lever is operated as a classic 'Flick Mixer'. The hot side is marked with a red mark and the cold side with a blue mark, for dispensing cold to warm water.

Lifting the handle up will decrease the flow rate and lowering the handle will increase the flow rate. Lift the handle all the way up to turn the tap off.

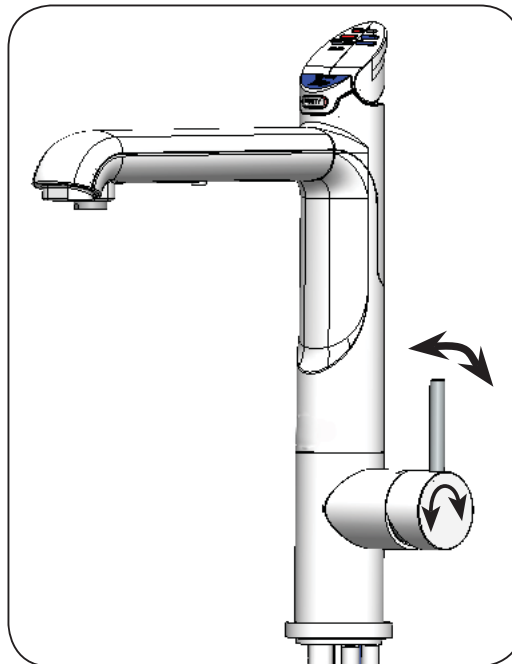

When the handle is moved towards the blue mark, the temperature is decreased and when moved towards the red mark, the temperature is increased. The final temperature will be dependant on the temperature of the incoming cold water.

For convenience, the spout may be swivelled, left or right through 120°.

Tap functions

HydroTap Arc/Cube:

On powerup, wait 30secs. for the unit to calibrate itself. Tapping the select button will allow the choice of Boiling (RED) with safety, Chilled (BLUE) or Sparkling (WHITE) water mode. The Arc/Cube control may be rotated in a forward or reverse direction to dispense Boiling or Chilled water.

The rotary control is spring loaded in the anticlockwise direction and when released, will return to the OFF position. When rotated clockwise the tap operates in a "Pot fill" mode. Water will flow from between 5 and 15 seconds (This is user adjustable). To reset, return the handle to the "Off" position and repeat the

step. The lever has to be manually returned to the "Off" position.

After activating the Boiling mode, all the lights will flash for 2 seconds, during which time you may dispense water. When the rotary control is returned to the Off position the light will continue to flash for an additional 3 seconds, allowing you to dispense more water.

When unattended, the control light will automatically default to the Chilled (BLUE) mode after 30 seconds.

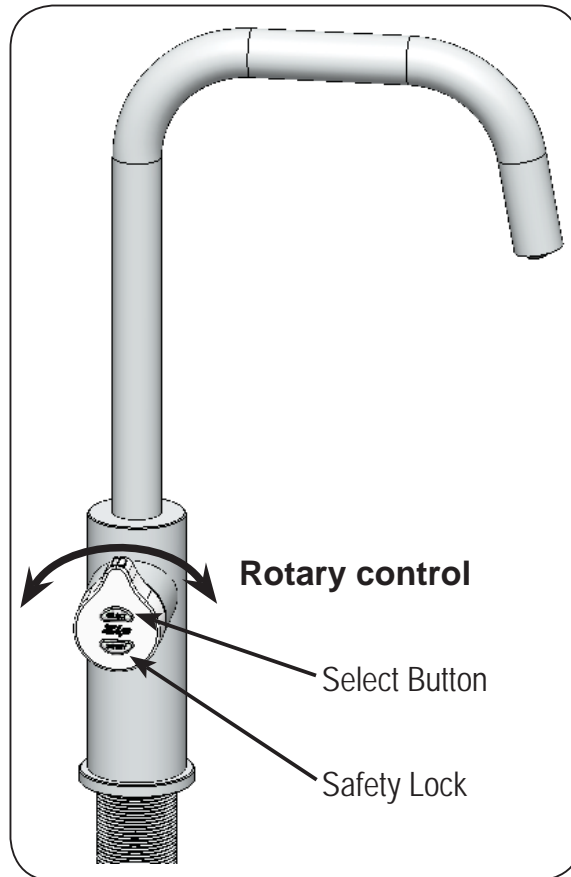

MixerTap:

Lifting the handle up will decrease the flow rate and lowering the handle will increase the flow rate. Raise the handle all the way up to turn the tap off.

When the handle is moved towards the BLUE mark, the temperature is decreased and when moved towards the RED mark, the temperature is increased. The final temperature will depend on the temperature of the incoming cold water.



Tap operation

To dispense chilled water:

Classic Tap

HydroTap Classic and All-In-One taps:

Depressing the "Blue" lever allows the dispensing of chilled water. Pulling forward the Blue lever allows the tap to operate in a "no-touch" mode. Water will flow from between 5 and 15 seconds (This is user adjustable). To reset, return the handle to the "Off" position and repeat the step. The lever has to be manually returned to the "Off" position.

NOTE:

Chilled water will not be dispensed, if the safety button is accidentally covered.

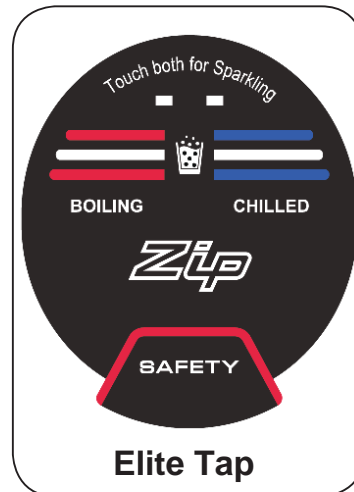

Elite Tap:

Touching the chilled button allows the dispensing of chilled water.

HydroTap Arc/Cube:

If not showing BLUE, tap the select button until the indicator light turns BLUE.

Rotating the control, when the indicator light is BLUE, allows the dispensing of chilled water.

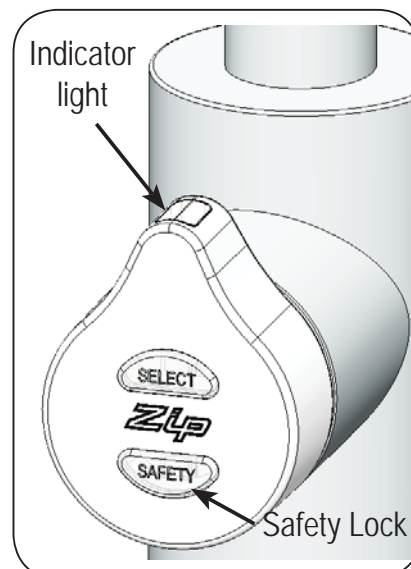

Arc/Cube Tap

To dispense boiling water: (With the safety OFF)

HydroTap Classic:

Depressing the Red lever allows the dispensing of boiling water.

Pulling forward the Red lever allows the tap to operate in a “no-touch” mode.

Water will flow from between 5 and 15 seconds (This is user adjustable).

To reset, return the handle to the “Off” position and repeat the step. The lever has to be manually returned to the “Off” position.

Elite Tap:

Touching the boiling button allows the dispensing of boiling water.

HydroTap Arc/Cube:

Tap the select button until the indicator light turns RED.

Rotating the control , when the indicator light is RED, allows the dispensing of boiling water.

To dispense Boiling water: (With the safety ON)

HydroTap Classic:

Depress the Red lever, while simultaneously covering the safety lock button with a second finger. These two actions need to occur simultaneously within 2 seconds for the successful dispensing of boiling water.

Elite Tap:

Place one finger on the safety lock, then touch the boiling button with a second finger while keeping both fingers in position.

These two actions need to occur simultaneously within 2 seconds for the successful dispensing of boiling water.

HydroTap Arc/Cube:

Tap the select button until the indicator light turns RED. Then tap the safety button twice until the RED light flashes (This will flash for aprox 2 seconds). Boiling water may be dispensed by rotating the control while the RED light is flashing.

Tap operation

To dispense Sparkling water:



HydroTap Classic and All-In-One taps:

Depressing both the 'Red' and the 'Blue' levers allows the dispensing of Sparkling water. Pulling forward both levers allows the tap to operate in a "no-touch" mode. Water will flow from between 5 and 15 seconds (This is user adjustable). To reset, return the handles to the "Off" position and repeat the step. The levers have to be manually returned to the "Off" position.



Elite Tap:

Touching both the boiling and chilled buttons simultaneously allows the dispensing of sparkling water.

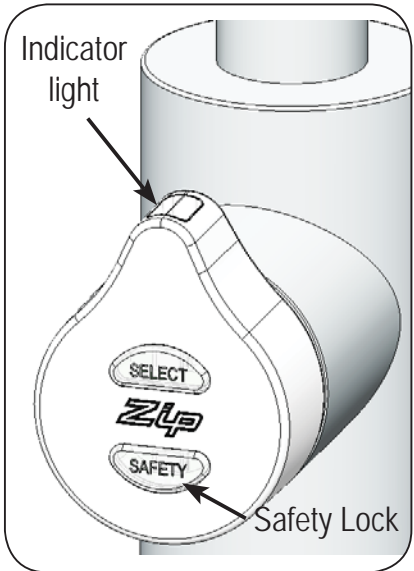

HydroTap Arc/Cube:

Tap the select button until the indicator light turns WHITE. Rotating the control, when the indicator light is WHITE, allows the dispensing of sparkling water. When unattended, the control light will automatically default to the Chilled (BLUE) mode after 30 seconds.

Tap lights

Red Boiling Water Light: (All)

On all the time:

This indicates that the boiling water is ready.

Flashing slowly:

This indicates that the boiling water is below the desired temperature.

Wait for the light to stop flashing before dispensing water. The flashing light will typically occur after switching on, or coming out of sleep mode.

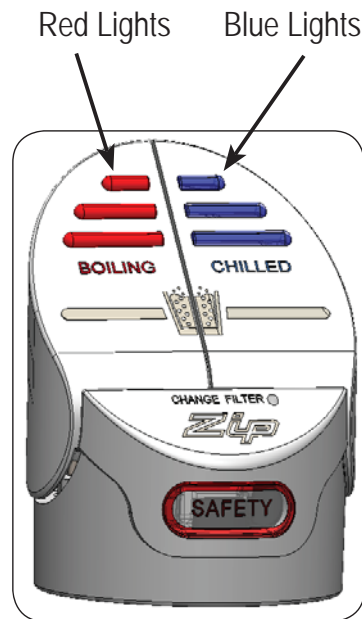

Blue Chilled Water Light:

(Not available on Elite)

On all the time:

This indicates that the temperature of the chilled water is within the set temperature range.

Flashing slowly:

This indicates that the chilled water is not within the set temperature range. While flashing, water may be dispensed, but not at the set temperature. When the chilled water is at the set temperature, the light will stop flashing. This may take several minutes.

During heavy usage, the temperature may rise out of the normal range.

Warning: (All)

Flashing warning light:

When the indicator light flashes fast and continuous, a system fault has occurred. Check for details on the faults screen. If unable to rectify, call a qualified service agent.

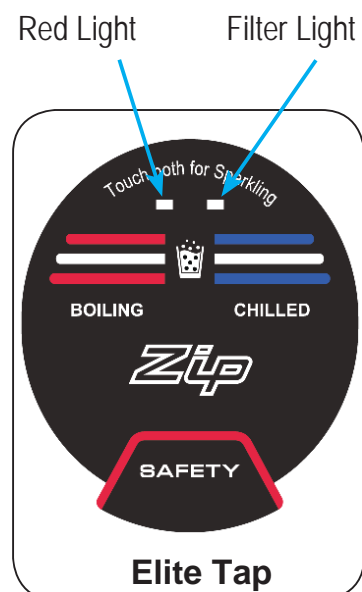

Filter Lights

Filter light: Classic; Elite & AIO

Filter Light Off:

This indicates the filter is operating within its normal specified lifespan.

Filter Change light flashing slowly:

The light will flash slowly when the filter is due for replacement and the LCD will show "Filter Change". Refer to "Replacing the filter" in section 'C' of this document.

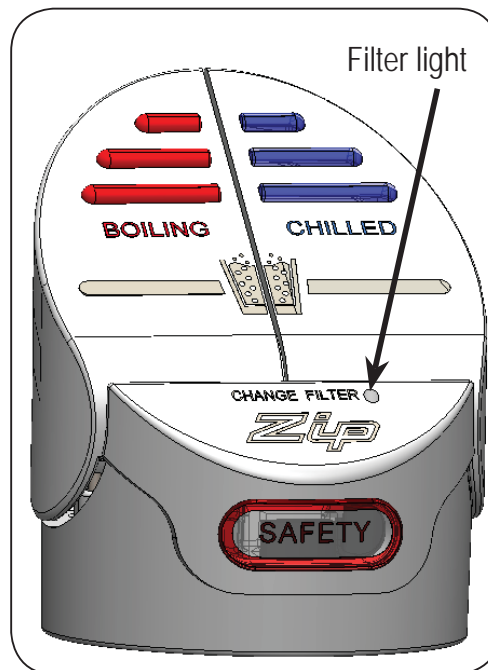

Classic Tap

Turn filter light OFF: (All models)

Refer to "Filter Reset" in section 'C' of this document.

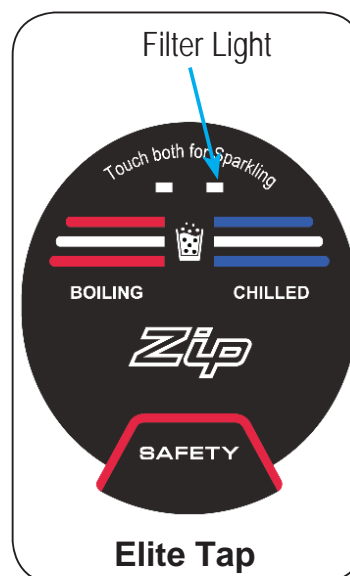

Elite Tap

HydroTap Arc/Cube:

Flashing filter lights:

All three tap lights (Safety; Select and Indicator light) will flash every 10 seconds, indicating a Filter change is required.

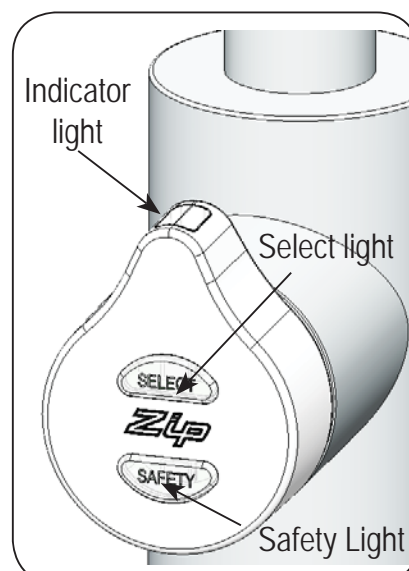

Safety Light

Safety Sensor Calibration (lever models)

Light intensity varies from site to site, therefore it is recommended that a re-calibration be performed at the time of the installation.

All direct natural sun light must be shaded from the HydroTap, during the calibration. This can be achieved by closing any nearby curtains, blinds, etc. or by shading the tap with a dark cloth.

1. With the unit in Normal operating mode and with the safety enabled
2. Turn the power OFF
3. Pull both tap levers to the forward position
4. Turn ON the power
5. The unit will calibrate the safety switch
6. Return the levers to the neutral position.
7. To check the calibration, dispense Boiling water, in normal light conditions with the safety enabled.

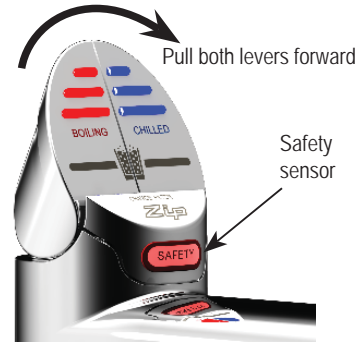

LCD Screen

Zip HydroTap G4 introduces a 'TOUCH' screen for easy setup and operation adjustment.

(See page 27 for Home Menu Items)

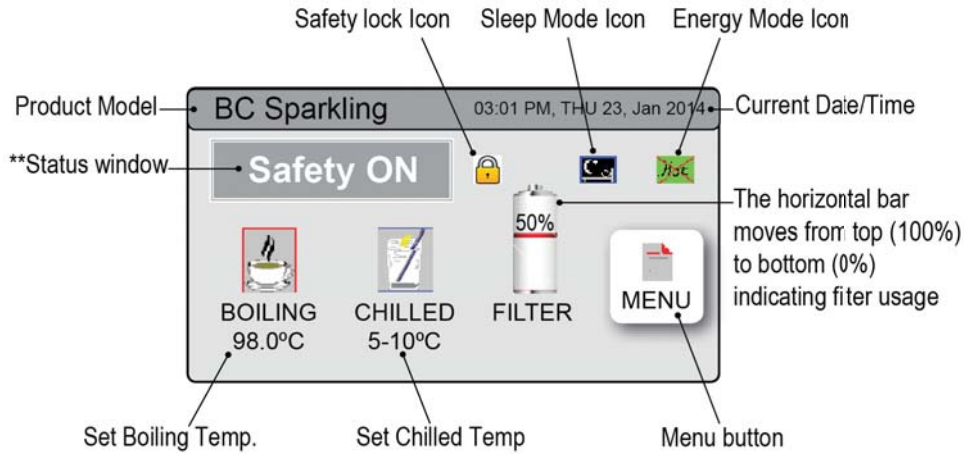

Other possible messages in status window:

Status**	Information	Notes
Safety OFF	Product is in normal operation mode	-
Safety ON	Safety lock is activated	Refer to section G - safety
System Fault	Product has one or more system faults	Refer to section B faults
Sleep Mode	System is in sleep mode. Boiling water or hot water is not available.	Refer to section G - Energy mode
Change Filter	External/Internal filter needs to be replaced	Refer to section C
System Off	System off in off mode. No boiling water or chilled water available.	Refer to section G - Energy mode
Hot Isolated	Hot isolation has been activated. Boiling water or hot water is not available.	Refer to section G - Safety

NOTE: As an energy saving feature, the home screen will turn OFF After 5 minutes of non use. Touching the darkened LCD panel will reactivate the home screen.

LCD Screen Menu

Main Menu	Sub Menu	Sub Menu Options	Section
Language	<ul style="list-style-type: none"> English 	<ul style="list-style-type: none"> Deutsch 	A
	<ul style="list-style-type: none"> Product Info System Faults Event Log 	<ul style="list-style-type: none"> Product serial no. Lists 	B
Information			
Installation	<ul style="list-style-type: none"> Filter Flush Filter Reset Boiling Calibration Booster Lux sensor calibration 	<ul style="list-style-type: none"> Reset options Calibration options 	C
Service	Password protected		D
Security	<ul style="list-style-type: none"> Enable Password 	<ul style="list-style-type: none"> Set Password Change Password 	E
Communication	<ul style="list-style-type: none"> Remote Monitor Remote Control 	<ul style="list-style-type: none"> Wifi / Bluetooth Options Wifi / Bluetooth Options 	F
Settings	<ul style="list-style-type: none"> Date/Time Temperature Filter Energy Modes Safety Dispense Times 	<ul style="list-style-type: none"> 12hr/24hr Mode Hot/Cold Setpoint Filter Life (Litres) Filter Life (Months) Sleep Mode Options Safety Lock Hot Isolation Hot/Cold Dispensing 	G

LCD Screen operation - Section A

A Set Language

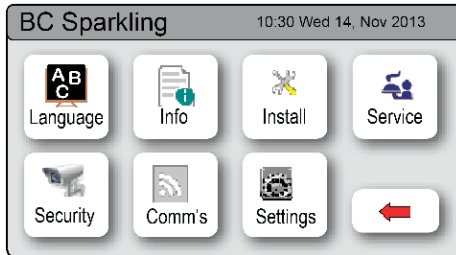

1. Press [MENU] for main menu.
2. Press [Language] button.
3. Select an option to change the language
4. Press [<=] button for the previous menu

LCD Screen operation - Section B

B System Information

In this section, you can find product information, system faults and check the filter logs of your product.

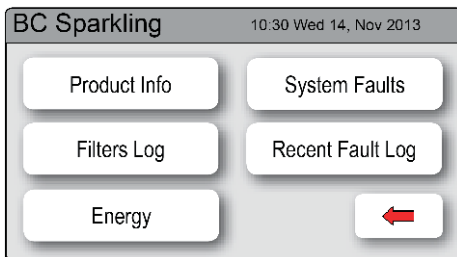

1. Press the [MENU] button for main menu.
2. Press the [Info] button to view the product serial number and other key information



1. Press [Product Info] to view the product information.
2. Press [<=] button for the previous menu or press [Home] button to return to the home screen.

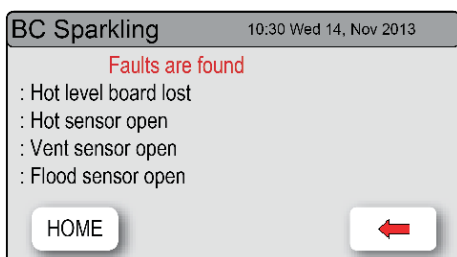

1. Press [System Faults] to check the fault information;
2. Press [<=] button for the previous menu or press [Home] button to return to the home screen.

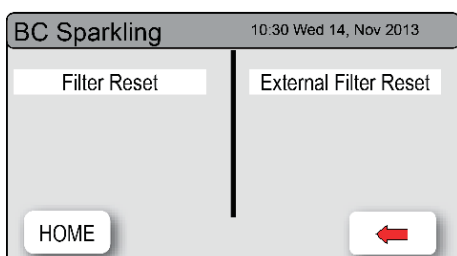

1. Press [Filter Log] to view the system's filter log.
2. Press [<=] button for the previous menu or press [Home] button to return to the home screen.

LCD Screen operation - Section C

C Install

Once your Zip HydroTap G4 unit has been installed, select the Install menu to configure the system settings for your product.

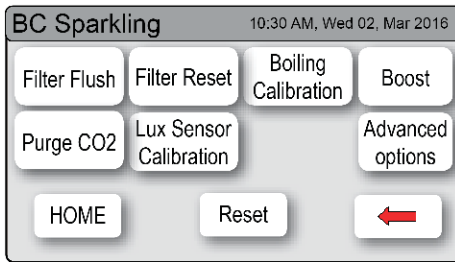

Sub menu:

1. - Filter Flush
2. - Filter Reset
3. - Boiling Calibration
4. - Booster
5. - Purge CO₂
6. - Lux Sensor Calibration

1. - Filter Flush

Have a 10L bucket or similar container (not supplied) at the ready to hold a quantity of water that will be ejected while the Filter Flush Mode is in operation. Open the filter access door on the front of the HydroTap and the filter cartridge will be exposed. Located to the rear RHS of the cartridge is a flush line, approx 600mm long and the flush line stop cock. Place the valve end of the flush line into the bucket or container.

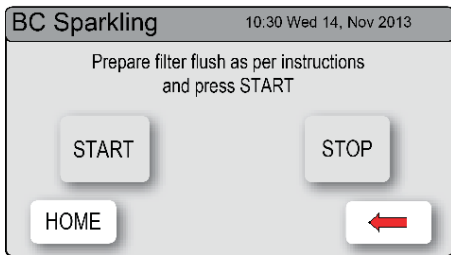

Note: Run at least 10 Ltrs of water through to flush the filter of any excess black carbon particles (this is normal), before pressing the Stop button. Once the filter flush has finished, press the Stop button to display the main menu

1. Press [MENU] button for main menu.
2. Press [Install] button. Turn the stop cock ON.
3. Press [Filter Flush] button.
4. Press [Start] button to start filter flush. Once the filter flush is finished, Turn the stop cock OFF first (to ensure the cock is properly closed) then press [Stop] to end filter flush mode.
5. Press [=<] button for the previous menu or press [Home] button to return to the home screen.
6. After initial installation, Turning OFF the Filter Flush Mode puts the HydroTap into calibration mode. With subsequent filter changes, the system reverts to the main menu.

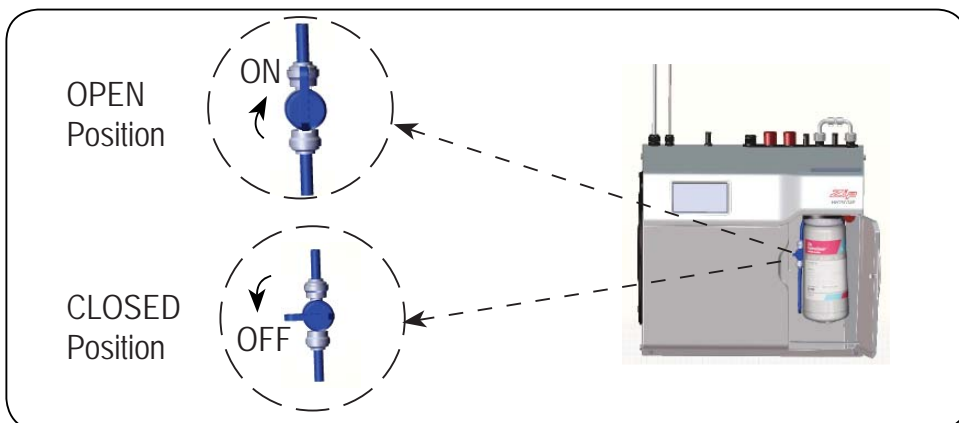

The Zip HydroTap allows the user to adjust the filter life and to edit the filter usage. (See filter details on Page 19).

LCD Screen operation - Section C

2. - Filter Reset

After replacing the filter, the counters should be reset

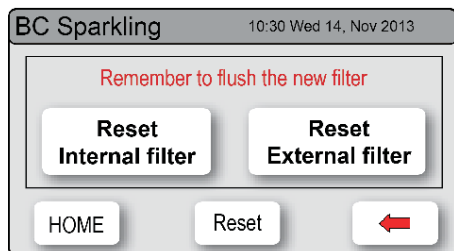

1. Press the [MENU] button for main menu.
2. Press the [Install] button.
3. Press the [Filter Reset] button.
4. To set the filter life or edit filter usage, refer to section G- Filter.

3 - Boiling Calibration

Caution: During calibration, boiling water units may vent steam from the tap spout. Take care to avoid personal injury whenever this occurs.

On start up, the Zip HydroTap starts a self-calibration program. The controls take the system through the calibration process. Once complete, the system reverts back to normal operation. If you would like to calibrate the system anytime after initial installation, please follow the steps below.

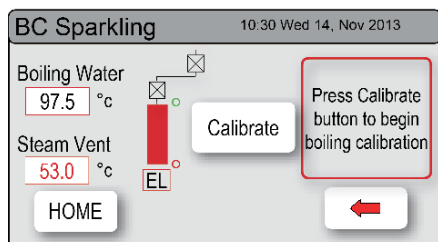

1. Press [MENU] button for main menu.
2. Press [Install] button.
3. Press [Boiling Calibration] button.
4. In the next screen, press [Calibrate] to start calibration.

4 - Booster

This function should only be considered when a Booster unit is installed.

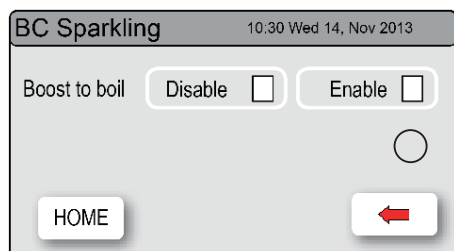

1. Press the [MENU] button for main menu.
2. Press the [Install] button.
3. Press the [Booster] button.
4. If a Booster is installed, select YES to enable the Booster.
5. Dispense boiling water for a minimum of 30 secs and check the outlet hose from the Booster is warm.
6. If no Booster is installed select NO,

Note: Failing to make the correct selection for 'Booster' will effect product performance.

LCD Screen operation - Section C

5 - Purge CO₂

When fitting a new gas bottle, it is important to purge the gas lines.

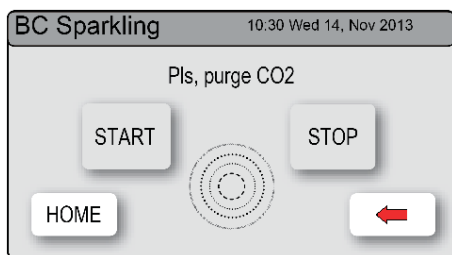
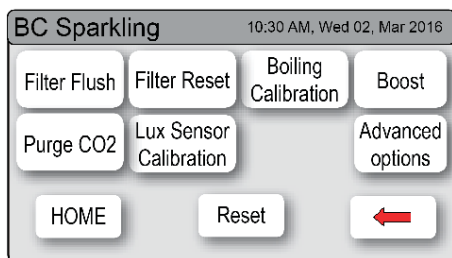

1. Press the [MENU] button for main menu.
2. Press the [Install] button.
3. Press the [Purge CO₂] button.
4. In the next screen, press the [START] button to commence the purging process.
5. Wait for the water to stop flowing through the unit.
6. Wait a further 10 seconds after the water has stopped flowing. During this time you will hear the CO₂ gas escaping through the tap.
7. Press [STOP] to end the purge.
8. Press [=] button for the previous menu or press the [Home] button to return to the home screen.

6 - Lux Sensor Calibration

NOTE: Conduct calibration under normal light conditions

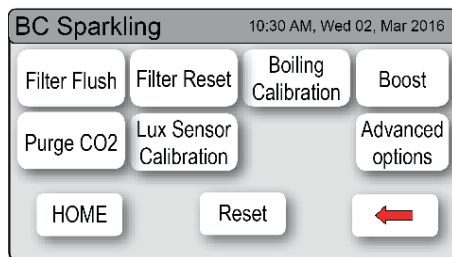

1. Press [MENU] button for main menu.
2. Press [Install] button.
3. Press [Lux Sensor Calibration] button.
4. The lights on the Tap head will flash to confirm calibration.
5. Check for correct tap operation by selecting 'Lux Sensor-> OFF'. When the room is darkened (below the calibrated light level), the tap lights will turn OFF after approx 30 seconds.

LCD Screen operation - Section D

D Service

This section is reserved for service technicians only

Note: In Australia call a licensed electrician, plumber, or Zip office on 1800-638-633, for assistance, service, spare parts, or enquiries.

LCD Screen operation - Section E

E Security

The Zip HydroTap G4 allows the appliance coordinator to set up a password to protect against users changing the preferred system settings.

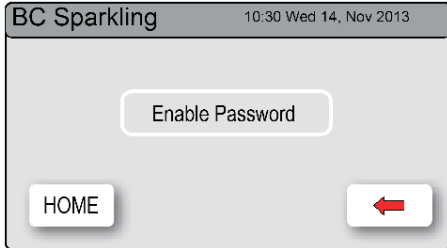

To set a password

1. Press [MENU] button for main menu.
2. Press [Security] button.
3. Press [Enable Password]
4. Enter a 4 digit password

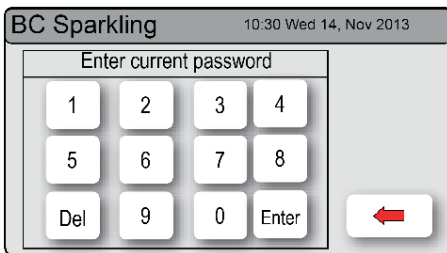

To change a password

1. Press [MENU] button for main menu.
2. Press [Security] button.
3. Press [Change Password]
4. Enter your old 4 digit password
5. Then enter your new 4 digit password. You will need to enter your password to access the settings screen. If you have forgotten the password, please disconnect the power and restart your HydroTap unit.

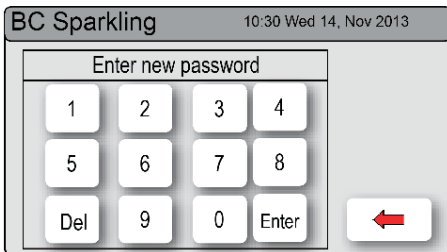

LCD Screen operation - Section F

F Communication (when available)

The Zip HydroTap G4 allows the user to use Wifi to monitor and control the product remotely.

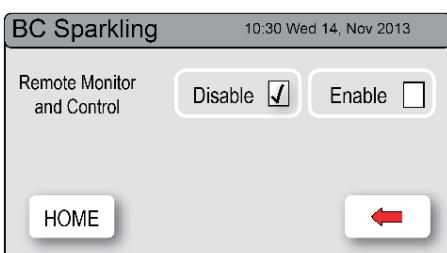

Not yet available

LCD Screen operation - Section G

G Settings

If, in section E, you have set a password, then you will need to enter your password to access the settings screens. If you have forgotten the password, please disconnect the power and restart your HydroTap unit.

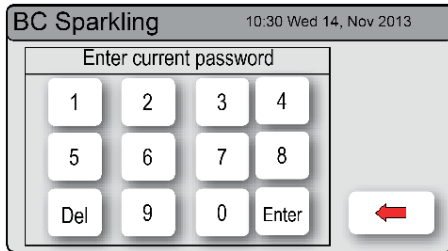

1. Press [MENU] button for main menu.
2. Press [Settings] button.
4. Then enter your 4-digit password.

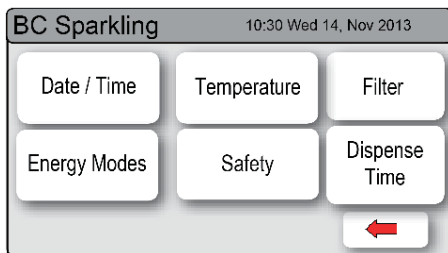

Set Date / Time

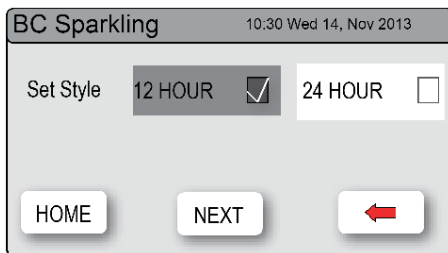

G4 HydroTap Set Date/Time Screen

1. Press [MENU] button for main menu.
2. Press [Setting] button.
3. Press [Date/Time] button.
4. Select 12 hour mode or 24 hour mode. The selected mode will be displayed in dark grey colour with a tick box on the right.
5. Press [NEXT] button to set time.

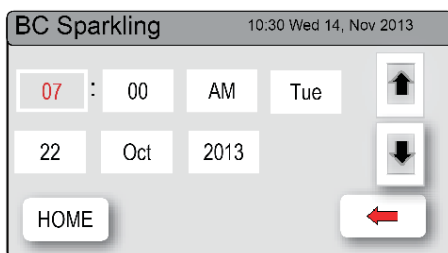

1. Select individually the hour, minutes and day and adjust using the up and down arrows.
2. Select individually the date, month and year and adjust using the up and down arrows.
3. Press [HOME] to return to the Home screen.

Set Temperature

Zip HydroTaps are designed to operate within 1°C to 2°C of set point for boiling water and between 3°C to 5°C for chilled drinking water. All boiling water units are self calibrating to 98°C, which is the recommended setting. Adjustments to the 98°C setting are not recommended however, under certain circumstances adjustments may be made between 68° - 100°C. It should be noted that a 6% energy saving in standby power can be achieved when the 98°C setting is selected over the 100°C setting. Furthermore, the 100°C setting is not recommended as the delivery rate of water may be affected.

LCD Screen operation - Section G

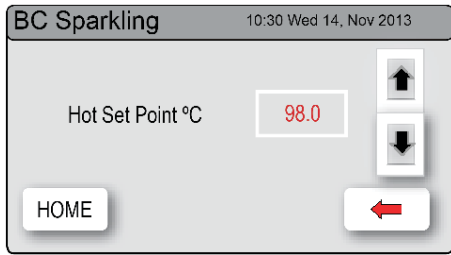

1. Press [MENU] button for main menu.
2. Press [Temperature] button.
3. To adjust the temperature, press the relevant temperature button and then use the up and down arrows.

Filter

Zip HydroTap G4 allows the user to adjust filter life and edit filter usage.

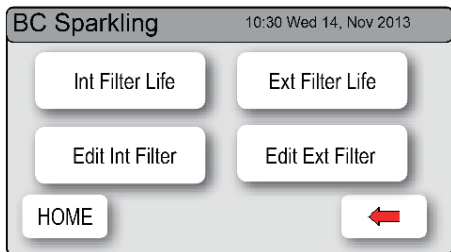

Note: The filter life may be set as a function of Litres used, or in months from the filter change. When the first of these functions is reached (i.e. Litres or months expired), the filter warning light will be illuminated on the tap. Either of these functions may be disabled (See below).

To edit the filter life:

1. Press [MENU] button for main menu.
2. Press [Setting] button.
3. Press [Filter] button.
4. Press [Filter Life] button, for Internal or External filter.
5. To change filter life, first select filter life (Litres) or filter life (Months), then adjust using the up or down arrows.

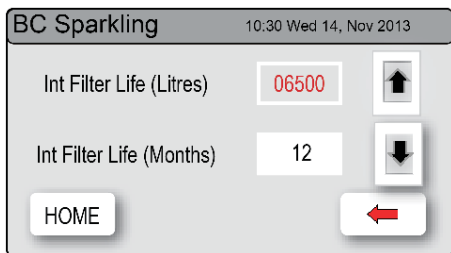

Note:

Filter Life increases in 500 litre increments to a maximum of 10000 litres. Factory set at 6000 litres.

To edit the filter usage:

This function is to reset the Filter Change display after a filter has reached the end of its life (refer to "Replace Filter Instructions" section of this document).

1. Press the [MENU] button for main menu.
2. Press the [Setting] button.
3. Press the [Filter] button.
4. Press the [Edit Filter] button for Internal or External filter.
5. To edit, select Edit Usage(Litres) or Edit Usage (Months), then adjust using the up or down arrows.
6. Press [HOME] to return to the Home screen.

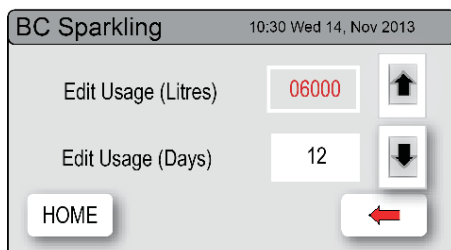

LCD Screen operation - Section G

Energy Modes

This mode allows the HydroTap to enter into Energy Saving mode. There are two options available: 'Sleep' mode and 'ON/OFF' mode.

In Sleep Mode the unit will go to "Sleep" after a 2hr period of inactivity. The Boiling water will gradually drop to either 68°C or room temp, as shown in the table below and the Chilled water will be ON or OFF.

When the period of inactivity passes, the home screen status window will show "Sleep Mode".

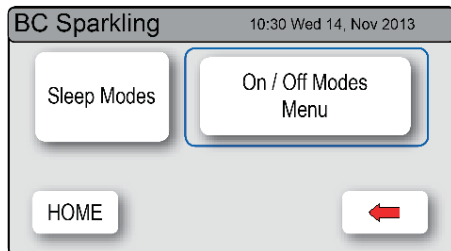

To activate the sleep mode:

1. Press [MENU] button for main menu.
2. Press [Setting] button.
3. Press [Energy Modes] button.
4. Press [Sleep Modes] button then in the next screen, use the up and down arrows to select one of the 7 options, as shown in the table below.

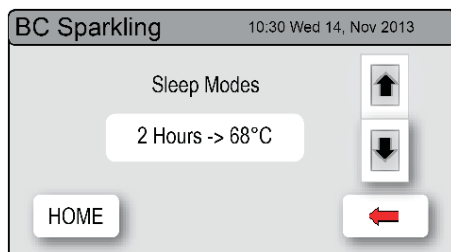

Sleep Mode	Light Level	Time Delay	State	Boiler	Chiller
2 Hours-> 68°C	N/A	2 Hr	Sleep	68°C	ON
2 Hours-> OFF	N/A	2 Hr	OFF	OFF	OFF
Lux Sensor->68°C	Dark	N/A	Sleep	68°C	ON
Lux Sensor-> OFF	Dark	N/A	OFF	OFF	OFF
Lux or 2 Hr-> 68°C	Dark	2 Hr	Sleep	68°C	ON
Lux or 2 Hr-> OFF	Dark	2 Hr	OFF	OFF	OFF
Disable	N/A	N/A	ON	ON	ON

Lux (Light) Sensor Calibration: (Not for Elite tap)

It is recommended to recalibrate the Lux (Light) Sensor after selecting any of the 4 Lux sensor options from the sleep mode menu. Before commencing, ensure there are 'Normal to Dim' (Not Dark) operating light conditions.

Note: Refer to section C6 on Page 16 for calibration procedure

LCD Screen operation - Section G

Note: Any attempt, during OFF mode, to dispense water, will bring the unit out of sleep mode. The unit will return to sleep mode after 2 hours of non use. Please allow sufficient time for the water to reach the set temperature after disabling the sleep mode.

In ON / OFF Mode the user may turn the unit ON or OFF at specific times for individual days or alternatively by weekly and/or weekend settings.

To activate ON/OFF mode:

1. Press the [MENU] button for main menu.
2. Press the [Setting] button.
3. If required, Enter your 4 digit password
4. Press the [Energy Modes] button.
5. Select 'Individual set' if you wish to allocate a specific time for each day.
6. Select 'group set 1' if you wish to allocate the same time to all 7 days
7. Select 'Group set 2' if you wish to allocate the same time to the 5 working days (Mon-Fri) and additional times for (Sat-Sun).

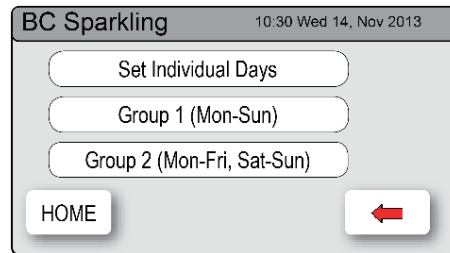

Individual days set screen

This screen allows you to select the individual days for programming. Only one ON /OFF period is allowed for each day.

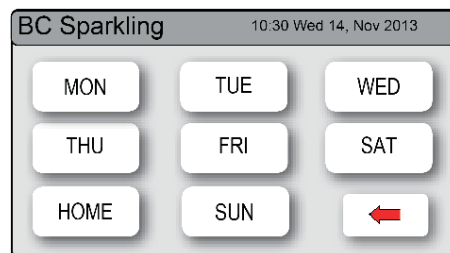

Group set screen

1. Press Group 1 or Group 2 option
2. Press button (A) to enable / disable group set. When the enable box is ticked, this allows each individual day to have an "On/Off" time.
3. Press [ON/OFF Modes] button, to set up ON/OFF time.
4. When in Group 2 Press [NEXT] to select Sat-Sun options

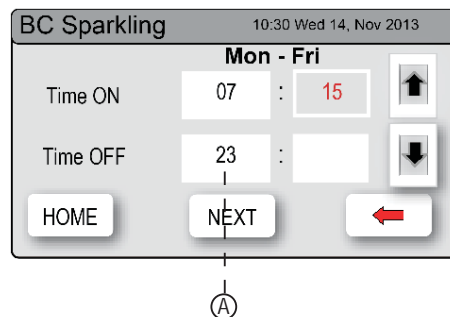

Note: Any attempt, during OFF mode, to dispense water, will bring the unit out of energy mode. The system will revert to the energy mode setting after 30 minutes of non use.

LCD Screen operation - Section G

Safety

To set the tap safety setting:

- Press [MENU] button for main menu.
- Press [Setting] button.
- Press [Safety] button.
- Press button (A) - YES to allow the safety setting to be changed on the Tap

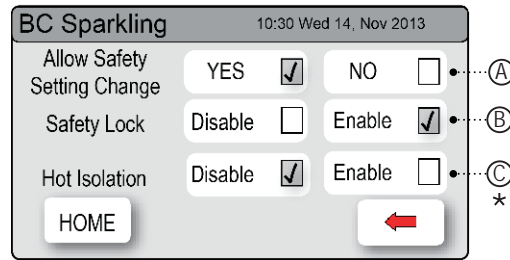

To Enable or Disable the safety on the tap

- Press button (B) to select Enable / Disable

Hot Isolation: (Not available for HydroTap Arc/Cube) *

The HydroTap is equipped with a safety mode that allows for additional safety protection, if needed.

When activated, the HOT Isolation mode will override the settings to ensure Boiling water is not dispensed.

To Activate the Hot Isolation:

- Press button (C) - to Enable / Disable Hot isolation.
- To operate the tap when in Hot Isolation mode, tap the Safety Lock (3) three times, after a few seconds the tap lights will flash (3) three times. This confirms de-activation and allows Boiling water to be dispensed. The Hot Isolation can be immediately set again, by tapping the safety lock (3) times.
- If the Hot Isolation is not re-enabled, it will be automatically re-enabled after 30 seconds of inactivity.

Note: * Hot Isolation - Not available for the HydroTap Arc/Cube Tap. Do not enable this function for the HydroTap Arc/Cube.

LCD Screen operation - Section G

Dispense Times

This gives you the ability to change the maximum dispensing time. The default settings for the maximum dispensing times is 15 seconds. Here, the operator may change both the Boiling, Chilled and Sparkling water dispensing times to between 5 and 15 seconds, in increments of 1 second.

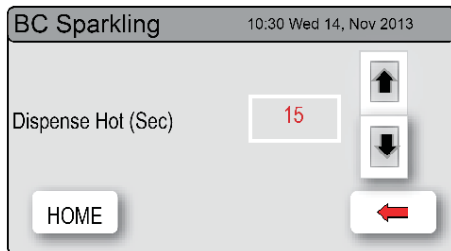

To edit the dispensing times:

1. Press [MENU] button for main menu.
2. Press [Setting] button.
3. Press [Dispense Time] button.
4. Select the option to change and scroll using the up and down arrow Keys

Filter Maintenance

Water Filter

The Zip HydroTap notifies when filter replacement is due. If you notice one of the following, you will need to change the filter:

- The Change Filter light will flash white once a second and remain so until reset.
- The filter percentage will show 0% on the Home screen.

Note: Depending on local water quality conditions and usage, the filter may require changing anywhere from 500 Litres to 10,000 Litres. You may also need to replace the filter if you notice unpleasant odours or tastes.

Some water may drip from the filter head (socket) during replacement. Keep a towel handy to dry up any drips.

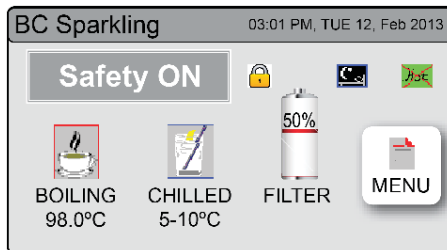

To change the Filter: (See also Section C)

- Open the door of the under sink unit.
- Relieve system pressure via the filter flush stop cock, a quick open and close will do. Use the bucket to catch the discharge.
- Grasp filter cartridge, depress the red lever at the top right of the filter and rotate the cartridge a quarter turn to the left, then gently pull down.

Filter Maintenance

- **Caution:** a small amount of water will drip as the cartridge is removed.
- Do not tilt the cartridge as water may spill from it if tilted.
- Unpack replacement cartridge and remove sanitary cap, write today's date where shown on the label.
- Avoid touching the filter O-rings and filter opening as this may cause bacterial contamination of the cartridge.
- Moisten the O-rings with water, align the front cartridge label to the left (as shown in the "insert filter" diagram for filter cartridge replacement), and push the new cartridge into the filter head.
- Turn the cartridge a quarter turn to the right until the cartridge comes to complete stop and is locked into position, with the front label facing forward.
- Initiate the filter flush programme by scrolling through the menu screen (See section C).
- When completed, wipe up any spills and dispose of spent filter cartridge and packaging thoughtfully.
- Close the door to secure the appliance.
- Adjust the filter settings in Section G - filter - Litres and Days used.

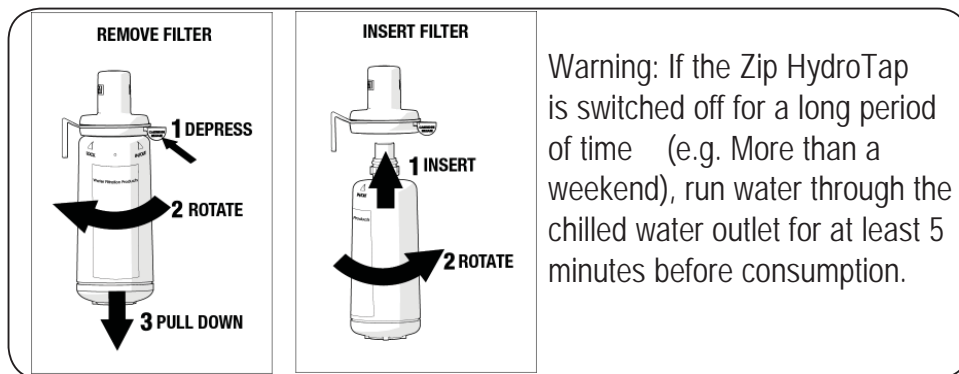

Air Inlet Filter

The Zip HydroTap air filter is conveniently located on the outside of the condenser. The filter screen is a sliding fit in the plastic housing on the side of the under sink unit. The screen may be removed for cleaning, by sliding it forward. This needs to be inspected at least quarterly, cleaned and replaced if damaged.

Note: For best performance the unit should only be operated with a clean air filter screen, correctly fitted in place. Maintain, at least, a 50mm air gap in front of the screen at all times. Take care not to allow cloths or other soft materials to accidentally block the air inlet.

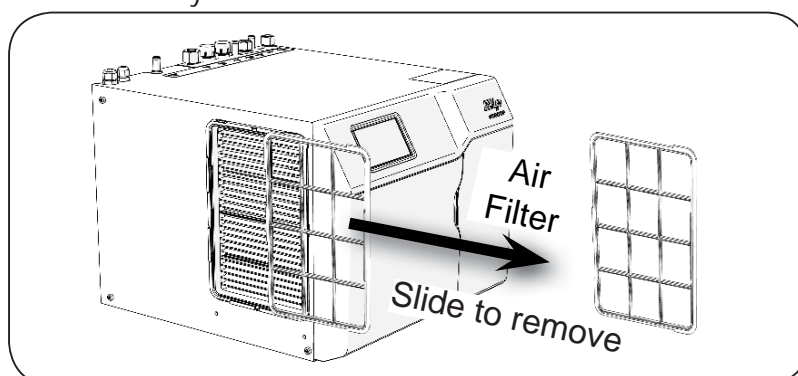

2.6kg Gas bottle change

1. Turn the CO₂ bottle, black knob, OFF (Clockwise).
2. Turn the regulator, grey knob, all the way out (Anti clockwise).
3. Dispense sparkling water for 30 seconds, until the water flow is free of gas
4. Remove the regulator assembly from the bottle by unscrewing the large chrome nut. It is not necessary to remove the hose from the regulator. Be aware that some CO₂ may be discharged from the bottle joint.
5. Be careful not to lose the plastic sealing washer, inside the chrome nut.
6. If the hose is removed from the regulator, be careful not to lose the sealing olive
7. Remove the bottle from the cradle by loosening the hook-and-loop securing strap.
8. Fit the regulator and hose assembly to the new gas bottle. Ensure all the seals are in place.
9. Fit the bottle in an upright position (use the hook-and-loop securing strap) and turn the gas valve ON..
10. Turn the regulator grey knob, ON (Clockwise) and adjust to between 2.7- 3.0 bar. (Green zone on dial).
11. Check all joints for gas leaks using a sponge and soapy water.
12. Press the [MENU] button for main menu.
13. Press the [Install] button.
14. Press the [Purge CO₂] button.
15. In the next screen, press the [START] button to commence the purging process.
16. Wait for the water to stop flowing through the unit. Then wait a few seconds more, until you hear only CO₂ gas escaping through the tap.
17. Press [STOP] to end the purge
18. Press [=] button for the previous menu or press the [Home] button to return to the home screen.
19. The display screen should revert to Normal operation.
20. Dispense some sparkling water from the tap and perform a taste test.

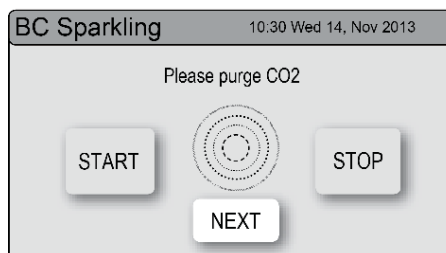
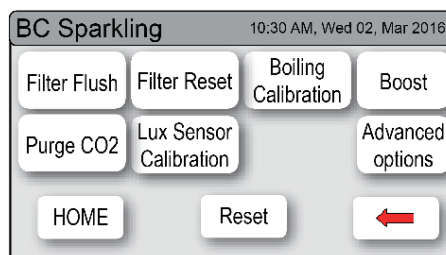

Note: Do not discard your empty 2.6kg bottle.

The 2.6kg bottles are refillable. Return the empty bottle to your nearest Zip service centre for exchange.

Cleaning

General cleaning

Do not use strong, corrosive, spray or abrasive cleaners. Clean with a soft damp cloth and mild soap.

Under sink units must never be located near, or cleaned with water jets.

Avoid using airborne pesticides near the undersink unit.

Home Menu Icons



Safety switch is LOCKED.

The HydroTap will not dispense any Boiling water. See page 2 for safety switch operation



Safety switch is UNLOCKED.

Boiling water may be dispensed. See page 5 for tap operation details

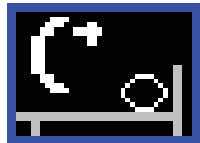

Sleep mode is active.

There are 7 sleep mode options which display this icon on the home screen. See page 20 for details.

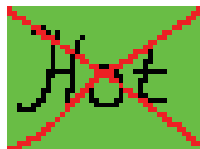

Heater is in OFF mode.

When this icon is displayed, no power is being supplied to the heating element. See pages 20 and 21 for Energy Mode options.



Filter use.

This icon displays the filter usage remaining from 100% (New filter) to 0% (end of life). When it reaches 0% the filter warning light on the tap head will flash slowly.

The filter life can be adjusted by litres and by days used. See page 19



BOILING
98°C

Boiling Temperature

The set temperature of the water in the Boiling tank will be displayed. This is optimised at 98°C but may be adjusted between 68°- 100°. See page 19 for hot set point adjustment.



CHILLED
3-5°C

Chilled Temperature

The set temperature of the water in the Chiller tank will be displayed. This will range from 3-5°C

Contact Details

Head Office

Zip Heaters (Aust) Pty. Ltd.
ABN: 46 000 578 727
67 Allingham Street
Condell Park NSW 2200
Postal: Locked Bag 80
Bankstown 1885 Australia

Website: www.zipwater.com
Facsimile: (02) 9796 3858
Telephone: (02) 9796 3100
Free Call: 1 800 638 633

As Zip policy is one of continuous product improvement, changes to specifications may be made without prior notice. Images in this booklet have been modified and may not be true representations of the finished goods.

The terms "Zip" and "HydroTap" are registered trade marks of Zip Heaters (Aust) Pty Ltd. Zip products described in this publication are manufactured under one or more of the following patents: AU675601, AU637412, AU635979, GB0422305, GB2065848, US4354049, US5103859, US5099825 and SA2006/08043. Other patents are in force and patent applications are pending.

