



**DRAPER**<sup>®</sup>

# 300 SERIES MULTIMETER

41821



**IMPORTANT:** Please read these instructions carefully to ensure the safe and effective use of this product and save these instructions for future reference. This manual has been compiled by Draper Tools and is an integrated part of the product with which it is enclosed and should be kept with it for future references.

This manual describes the purpose for which the product has been designed and contains all the necessary information to ensure its correct and safe use. We recommend that this manual is read before any operation or, before performing any kind of adjustment to the product and prior to any maintenance tasks. By following all the general safety instructions contained in this manual, it will ensure both product and operator safety, together with longer life of the product itself.

All photographs and drawings in this manual are supplied by Draper Tools to help illustrate the operation of the product. Whilst every effort has been made to ensure accuracy of information contained in this manual, the Draper Tools policy of continuous improvement determines the right to make modifications without prior warning.

# 1. TITLE PAGE

---

## 1.1 INTRODUCTION:

USER MANUAL FOR:

### SERIES 300 MULTIMETER

Stock no. 41821.

Part no. DMM300.

## 1.2 REVISIONS:

---

Date first published March 2017

---

Date second published June 2017

---

---

As our user manuals are continually updated, users should make sure that they use the very latest version.

Downloads are available from: <http://www.drapertools.com/manuals>

DRAPER TOOLS LIMITED

HURSLEY ROAD

CHANDLER'S FORD

EASTLEIGH

HAMPSHIRE

SO53 1YF

UK

WEBSITE:

drapertools.com

PRODUCT HELPLINE:

+44 (0) 23 8049 4344

GENERAL FAX:

+44 (0) 23 8026 0784

## 1.3 UNDERSTANDING THIS MANUALS SAFETY CONTENT:

**WARNING!** Information that draws attention to the risk of injury or death.

**CAUTION!** Information that draws attention to the risk of damage to the product or surroundings.

## 1.4 COPYRIGHT © NOTICE:

Copyright © Draper Tools Limited.

Permission is granted to reproduce this publication for personal & educational use only.

Commercial copying, redistribution, hiring or lending is prohibited.

No part of this publication may be stored in a retrieval system or transmitted in any other form or means without written permission from Draper Tools Limited.

In all cases this copyright notice must remain intact.

## 2.1 CONTENTS

<b>Page content</b> .....	<b>Page</b>
1 TITLE PAGE	
1.1 INTRODUCTION .....	2
1.2 REVISION HISTORY .....	2
1.3 UNDERSTANDING THIS MANUAL .....	2
1.4 COPYRIGHT NOTICE .....	2
2 CONTENTS	
2.1 CONTENTS .....	3
3 GUARANTEE	
3.1 GUARANTEE .....	4
4 INTRODUCTION	
4.1 GENERAL SPECIFICATIONS .....	5-7
4.2 HANDLING & STORAGE .....	8
5 HEALTH & SAFETY INFORMATION	
5.1 SAFETY PRECAUTIONS .....	9
6 IDENTIFICATION .....	10
7 UNPACKING & CHECKING	
7.1 PACKAGING .....	11
7.2 WHAT'S IN THE BOX? .....	11
8 OPERATING INSTRUCTIONS	
8.1 DATA HOLD .....	12
8.2 MAXIMUM VALUE HOLD .....	12
8.3 FUNCTION TRANSFORM .....	12
8.4 BACK LIGHT .....	12
8.5 AUTO WARNING .....	12
8.6 AUTO POWER OFF .....	12
8.7 DC VOLTAGE .....	13
8.8 AC VOLTAGE .....	13
8.9 DC CURRENT .....	13
8.10 AC CURRENT .....	13
8.11 RESISTANCE ( $\Omega$ ) .....	14
8.12 MEASURING ENGINE DWELL .....	14
8.13 MEASURING REV .....	14
8.14 TESTING DIODE .....	14
8.15 CONTINUITY TEST .....	14
9 MAINTENANCE	
9.1 MAINTENANCE .....	15
10 EXPLANATION OF SYMBOLS	
10.1 FUNCTION KEYS EXPLAINED .....	16
10.2 EXPLANATION OF SYMBOLS .....	17
11 DISPOSAL	
11.1 DISPOSAL .....	18
DECLARATION OF CONFORMITY .....	ENCLOSED

## 3. GUARANTEE

---

### 3.1 GUARANTEE

Draper tools have been carefully tested and inspected before shipment and are guaranteed to be free from defective materials and workmanship.

Should the tool develop a fault, please return the complete tool to your nearest distributor or contact Draper Tools Limited, Chandler's Ford, Eastleigh, Hampshire, SO53 1YF.

England.

Telephone Sales Desk: (023) 8049 4333 or Product Helpline (023) 8049 4344.

A proof of purchase must be provided with the tool.

If upon inspection it is found that the fault occurring is due to defective materials or workmanship, repairs will be carried out free of charge. This guarantee period covering parts/labour is 12 months from the date of purchase except where tools are hired out when the guarantee period is 90 days from the date of purchase. This guarantee does not apply to normal wear and tear, nor does it cover any damage caused by misuse, careless or unsafe handling, alterations, accidents, or repairs attempted or made by any personnel other than the authorised Draper warranty repair agent.

Note: If the tool is found not to be within the terms of warranty, repairs and carriage charges will be quoted and made accordingly.

This guarantee applies in lieu of any other guarantee expressed or implied and variations of its terms are not authorised.

Your Draper guarantee is not effective unless you can produce upon request a dated receipt or invoice to verify your proof of purchase within the guarantee period.

Please note that this guarantee is an additional benefit and does not affect your statutory rights.

Draper Tools Limited.

## 4.1 GENERAL SPECIFICATIONS

Auto ranges and manual range.

Over range protection for all ranges.

Max. Voltage Between Terminals And Earth Ground: 600V DC or AC

Operating Altitude: 2000 meters (7000 ft.)maximum

LCD Display: 19.5mm height character

Max. Show Value: 1999 (3 1/2)

Polarity Indication: '-' indicates negative polarity.

Over range Indication: Display 'OL'

Sampling Time: approx. 0.4 second

Unit showing: showing of function and electrical capacity.

Low Battery Indication: "⎓" displayed

Auto power off time: 15 min.

Power Supply: 1.5V×2 AAA batteries.

Operating Temperature: 0°C to 40°C (32°F to 104°F)

3.1.15 Storage Temperature: -10°C to 50°C (10°F to 122°F)

3.1.16 Dimension: 150×74×43mm

3.1.17 Weight: approx. 233 g (including battery)

## DC Voltage

Range	Accuracy	Resolution
200mV	± (0.7% of rdg + 3 digits)	0.1mV
2V		0.001V
20V		0.01V
200V		0.1V
600V	± (1.0% of rdg + 3 digits)	1V

Input Impedance: 10M

Overload Protection:

200mV range: 250V DC or AC rms,

2V-600V ranges: 600V DC or AC rms.

Max. Input Voltage: 600V DC

## 4. INTRODUCTION

---

### AC Voltage

Range	Accuracy	Resolution
200mV	$\pm(0.8\% \text{ rdg} + 5 \text{ digits})$	0.1mV
2V		0.001V
20V		0.01V
200V		0.1V
600V	$\pm(1.0\% \text{ rdg} + 5 \text{ digits})$	1V

- Input Impedance: 10M
- Overload Protection:
  - 200mV range: 250V DC or AC rms,
  - 2V-600V ranges: 600V DC or AC rms.
- Frequency Range: 40 to 400Hz
- Max. Input Voltage: 600V rms AC

### DC Current

Range	Accuracy	Resolution
2A	$\pm(2.5\% \text{ rdg} + 10 \text{ digits})$	0.001A
10A		0.01A

- Overload Protection: 500V/10A FUSE
- Max. Input Current:10A
- Voltage drop: 2A range: 20mV,  
10A range: 100mV

### AC Current

Range	Accuracy	Resolution
2A	$\pm(3.0\% \text{ rdg} + 10 \text{ digits})$	0.001A
10A		0.01A

- Overload Protection: 500V/10A FUSE
- Max. Input Current:10A
- Frequency Range: 40 to 400Hz
- Voltage drop :2A range: 20mV, 10A range: 100mV

## 4. INTRODUCTION

### Resistance

Range	Accuracy	Resolution
200Ω	$\pm(1.0\% \text{ rdg} + 5 \text{ digits})$	0.1Ω
2kΩ	$\pm(1.0\% \text{ rdg} + 2 \text{ digits})$	0.001kΩ
20kΩ		0.01kΩ
200kΩ		0.1kΩ
2MΩ		0.001MΩ
20MΩ	$\pm(1.2\% \text{ rdg} + 5 \text{ digits})$	0.01MΩ

- Open Circuit Voltage: 0.25V
- Overload Protection: 250V DC or 250V rms AC

### Continuity Test

Range	Function
	Built-in buzzer will sound, if resistance is lower than 50Ω

- Open circuit voltage: approx. 0.5V
- Overload Protection: 250V DC or 250V rms AC

### Engine Dwell

Range	Accuracy	Resolution
4CYL	$\pm(3^\circ)$	0.1°
6CYL	$\pm(3^\circ)$	0.1°
8CYL	$\pm(3^\circ)$	0.1°

- Overload Protection: 250V DC or rms AC

### Engine Rev

Range	Accuracy	Resolution
4CYL	$\pm(3.0\% \text{ rdg} + 3 \text{ digits})$	10RPM
6CYL		10RPM
8CYL		10RPM

- Overload Protection: 250V DC or rms AC

### Diode

Range	Resolution	Function
	1mV.	Display: read approximate forward voltage of diode.

- Forward DC Current: approx. 1mA
- Reversed DC Voltage: approx. 1.5V
- Overload Protection: 250V DC or rms AC

## 4. INTRODUCTION

---

### **4.3 HANDLING & STORAGE**

Care must still be taken when handling, dropping this machine will have an effect on the accuracy.

The environment will have a negative result on its operation if you are not careful. If the air is damp, components will rust. If the machine is unprotected from dust and debris; components will become clogged.

# 5. HEALTH & SAFETY INFORMATION

---

## 5.1 SAFETY PRECAUTIONS

This instrument complies with IEC1010 (International Electrotechnical Commission promulgated safety standards). Design and production using the pollution level 2 safety requirements.

 **Warning**

To avoid electrical shock or personal injury.  
Please read the safety information and “warnings and precautions” before use.

Warning: When measuring voltage above 30V, current above 10ma, AC power with an inductive load. Use caution not to touch exposed contacts due to the risk of electric shock, only use approved probes or clamps.

1. Before measuring, check whether the measurement function switch is in the correct position, check whether the test probe is connected correctly to avoid electric shock.
2. The meter is only to be used in conjunction with the supplied test leads to comply with safety standards. If the test leads are broken or damaged, replace the test leads of the same type or the same electrical specifications.
3. Do not use an unapproved fuse to replace the fuse inside the meter. Only replace with the same model or the same specifications of the fuse. Before changing, remove the test leads to ensure that there is no signal input.
4. Do not use unapproved batteries to replace the battery inside the meter. Replace only with the same model or the same electrical specifications of the battery. Before changing, remove the test leads to ensure that there is no signal input.
5. During electrical measurements, the body must not be directly in contact with the earth, use insulating materials to keep your body insulated from the earth.
6. Do not store or use in high temperature, high humidity, flammable, explosive and strong magnetic field environments.
7. Measurements exceeding the limit values of the instrument may damage the instrument and endanger the safety of the operator.
8. Do not attempt to calibrate or service the instrument.
9. When the LCD shows “”, please replace the battery.
10. Do not insert the test leads to be inserted into the current terminals to measure the voltage!

## 6. IDENTIFICATION

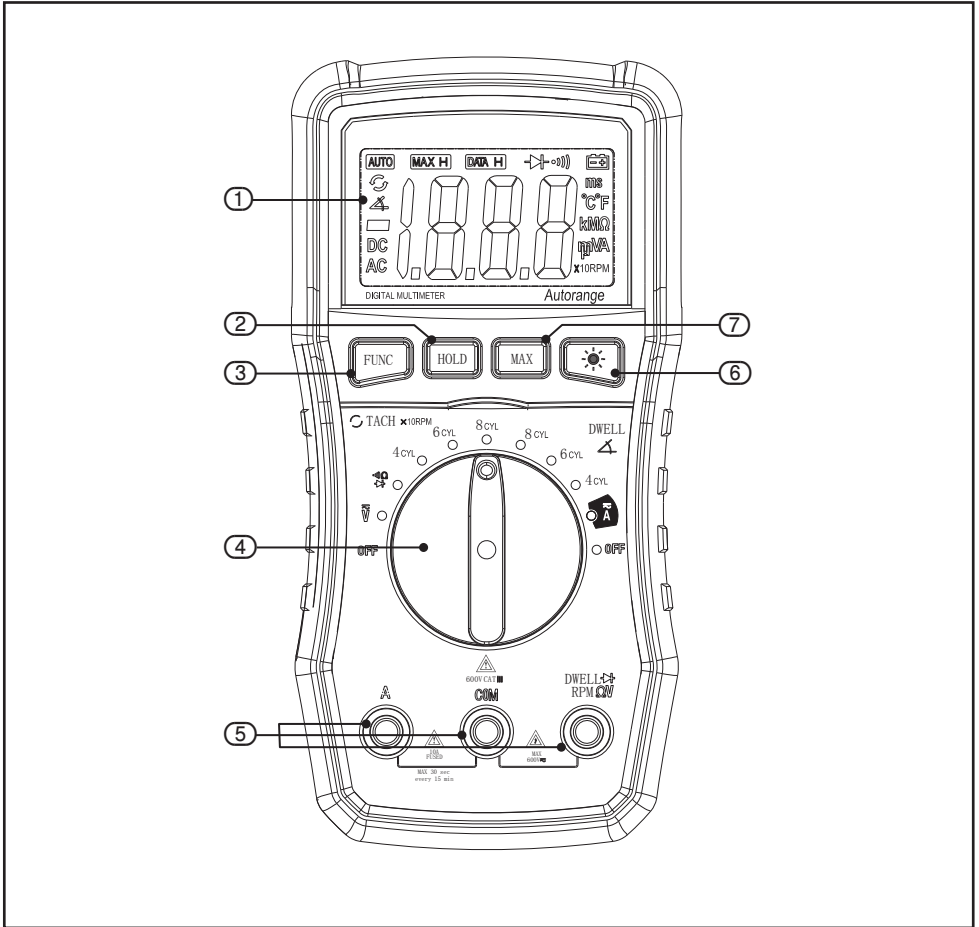

- |                                      |                         |
|--------------------------------------|-------------------------|
| ① LCD display window.                | ⑤ Probe sockets.        |
| ② HOLD button.                       | ⑥ Backlight on and off. |
| ③ Function button.                   | ⑦ Max. button.          |
| ④ Measurement function range switch. |                         |

## 7. UNPACKING & CHECKING

### 7.1 PACKAGING

Carefully remove the product from the packaging and examine it for any sign of damage caused during shipping. Lay the contents out and check them. If any part is damaged or missing, do not attempt to use the tool and contact the Draper Helpline immediately (see back page for details).

Retain the packaging material at least during the guarantee period: in case the machine needs to be returned for repair.

Warning! Some of the packaging materials used may be harmful to children, keep them out of reach from children.

Disposed of any packaging correctly and according to local regulations.

### 7.2 WHAT'S IN THE BOX?

As well as the product, there are several parts not fitted or attached to it.

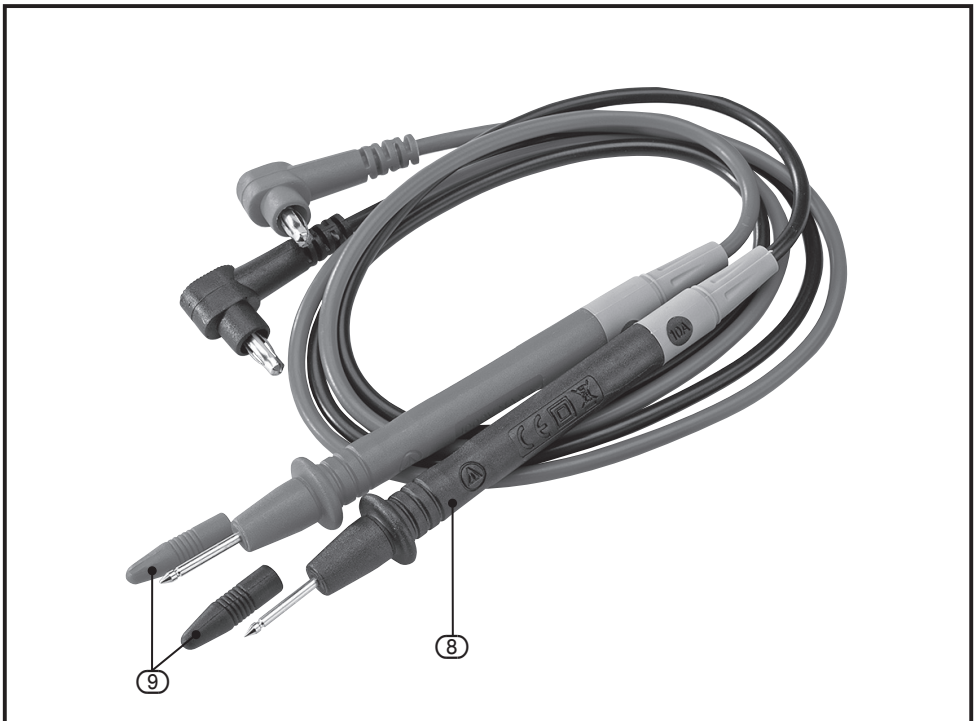

⑧ Test probe

⑨ Test probe caps

## 8. OPERATING INSTRUCTIONS

---

### 8.1 DATA HOLD

If you need to hold the data when measuring, press the "HOLD" button, if you press the button again, the data hold will switch off.

### 8.2 MAXIMUM VALUE HOLD

If you need data to hold the maximum data when measuring, press the "MAX" button, if you press the button again, maximum value hold will switch off.

### 8.3 FUNCTION TRANSFORM

Press the "FUNC." when measuring the current and voltage, the meter will switch between DC and AC range. Press "FUNC." When measuring the resistance, diode and continuity, the meter will switch to the correct measurement function.

### 8.4 BACK LIGHT

Press "" button for two seconds to turn on or turn off the back light, the back light will stay on for 15 seconds.

Note:

A. Frequent use of the back light will shorten the battery life.

### 8.5 AUTO WARNING

If the input current is larger than 10A the buzzer will sound.

### 8.6 AUTO POWER OFF

1. After fifteen minutes without any operation the meter will automatically switch off.
2. To disable the auto power off function press and hold the "FUNC" key when switching the meter on.

# 8. OPERATING INSTRUCTIONS

---

## 8.7 DC VOLTAGE

### **⚠ WARNING**

**Do not use on voltages above 600V DC.**

1. Connect the black test lead to the COM probe socket and the red test lead to the V/ $\Omega$  probe socket.
2. Set the measurement function range switch to the  $\tilde{V}$  position.
3. Press the "FUNC." button to enter the DC measurement.

## 8.8 AC VOLTAGE

### **⚠ WARNING**

**Do not use on voltages above 600V rms AC.**

1. Connect the black test lead to the COM probe socket and the red test lead to the V/ $\Omega$  probe socket.
2. Set the measurement function range switch to the  $\tilde{V}$  position.
3. Press the "FUNC." button to enter the AC measurement.

## 8.9 DC CURRENT

1. Connect the black test lead to the COM probe socket and the red test lead to the 10A probe socket.
2. Set the measurement function range switch to the  $\tilde{A}$  position.
3. Press the "FUNC." to enter the DC measurement.

### **⚠ Notes:**

“ $\tilde{A}$ ” 10A probe socket has the maximum input current of 10A, Overload Protection: 500V/10A FUSE

## 8.10 AC CURRENT

1. Connect the black test lead to the COM probe socket and the red test lead to the 10A probe socket.
2. Set the measurement function range switch to the  $\tilde{A}$  position.
3. Press the "FUNC." to enter the AC measurement.

### **⚠ Notes:**

“ $\tilde{A}$ ” 10A probe socket has the maximum input current of 10A, Overload Protection: 500V/10A FUSE.

## 8. OPERATING INSTRUCTIONS

---

### 8.11 RESISTANCE ( $\Omega$ )

1. Connect the black test lead to the COM probe socket and the red test lead to the V/ $\Omega$  probe socket.
2. Set the measurement function range switch to the  $\Omega$  position.

#### $\triangle$ Notes:

If the resistance is more than 1M $\Omega$ , the meter will need several seconds to stabilize its readings.

### 8.12 MEASURING ENGINE DWELL

1. Connect the black test lead to the COM probe socket and the red test lead to the V/ $\Omega$  probe socket.
2. Set the measurement function range switch to the desired DWELL range position.

### 8.13 MEASURING REV

1. Connect the black test lead to the COM probe socket and the red test lead to the V/ $\Omega$  probe socket.
2. Set the measurement function range switch to the desired TACH range position.

### 8.14 TESTING DIODE

1. Connect the black test lead to the COM probe socket and the red test lead to the V/ $\Omega$  probe socket.
2. Set the measurement function range switch to " $\rightarrow$ " position.
3. Press the "FUNC." key to switch to  $\rightarrow$  test.

### 8.15 CONTINUITY TEST

#### $\triangle$ WARNING

**When testing the circuit continuity, be sure that the power to the circuit has been shut down and all capacitors have been discharged fully.**

1. Connect the black test lead to the COM probe socket and the red test lead to the V/ $\Omega$  probe socket.
2. Set the measurement function range switch to the  $\infty$ ) position.
3. Press the "FUNC." key to switch the  $\infty$ ) continuity test.

#### $\triangle$ Note:

If the circuit is open (or the circuit resistance is higher than 200 $\Omega$ ), then the figure 'OL' will be displayed.

### 9.1 BATTERY REPLACEMENT

#### **⚠ WARNING**

Before attempting to open the battery cover of the meter, be sure that test leads have been disconnected.

# 10. EXPLANATION OF SYMBOLS

---

## 10.1 KEYS EXPLANATIONS

- **"FUNC" button:**

Measuring the current and voltage, the meter will switch between DC and AC range. or when measuring the resistance, diode and continuity, the meter will switch to the correct measurement function.

- **"HOLD" button:**

Used to hold data on screen.

- **"MAX" button:**

Used to hold maximum value on screen.

- **"" button:**

This button is used to the switch on/off back light.

# 10. EXPLANATION OF SYMBOLS

---

## 10.2 EXPLANATION OF SYMBOLS



WEEE  
Do not dispose of Waste Electrical & Electronic Equipment in with domestic rubbish



For indoor use.  
Do not expose to rain.



Class II construction  
(Double insulated)



Conforms to all relevant safety standards.



Earth



Fuse



Back light



Warning!  
Read instruction manuals before operating and servicing this equipment.



Diode test



Dwell angle



Tachometer



Max reading hold



Attention.



High voltage / current!  
Danger.



Voltage AC



Voltage DC



Current DC



Current AC



Resistance in Ohms



Continuity test buzzer



Data hold / Screen lock



Auto power off



Low battery display

## 11.1 DISPOSAL

- At the end of the machine's working life, or when it can no longer be repaired, ensure that it is disposed of according to national regulations.
- Contact your local authority for details of collection schemes in your area.

In all circumstances:

- Do not dispose of power tools with domestic waste.
- Do not incinerate.
- Do not abandon in the environment.
- Do not dispose of WEEE\* as unsorted municipal waste.



\* Waste Electrical & Electronic Equipment.

# NOTES

---

## **CONTACT US**

Draper Tools Limited, Hursley Road,  
Chandler's Ford, Eastleigh, Hampshire. SO53 1YF. U.K.

Helpline: +44 (0) 23 8049 4344

Sales Desk: +44 (0) 23 8049 4333

Internet: [www.drapertools.com](http://www.drapertools.com)

E-mail: [sales@drapertools.com](mailto:sales@drapertools.com)

General Enquiries: (023) 8026 6355

**Service/Warranty Repair Agent:**

For aftersales servicing or warranty repairs, please contact the Draper Tools Helpline for details of an agent in your local area.

YOUR DRAPER STOCKIST