



Thinking of you
Electrolux



.....
User manual

.....
Refrigerator

.....
ETE5207
ETE4407
EBE5107
EBE4307
ERM4307
EFM3607
ETM5200

.....
ETM4200
EBM5100
EBM4300
EBE5100
EBE4300
ERM3701
EFM3001



WE'RE THINKING OF YOU

Thank you for purchasing an Electrolux appliance. You've chosen a product that brings with it decades of professional experience and innovation. Ingenious and stylish, it has been designed with you in mind. So whenever you use it, you can be safe in the knowledge that you'll get great results every time.

Welcome to Electrolux.

LEGEND

The symbols you will see in this booklet have these meanings:



WARNING!

This symbol indicates information concerning your personal safety



CAUTION!

This symbol indicates information on how to avoid damaging the refrigerator



IMPORTANT!

This symbol indicates tips and information about use of the refrigerator



ENVIRONMENT!

This symbol indicates tips and information about economical and ecological use of the refrigerator

CONDITIONS OF USE

This appliance is intended to be used in household and similar applications such as:

- Staff kitchen areas in shops, offices and other working environments
- Farm houses
- By clients in hotels, motels and other residential type environments
- Bed and breakfast type environments.
- Catering and similar non-retail applications

RECORD MODEL AND SERIAL NUMBER HERE:

Model: _____

Serial No: _____

CONTENTS

3	Before using your appliance
3	Important safety instructions
4	General warnings
5	Top mount freezer model features
5	Bottom mount freezer model features
6	Single door all refrigerator model features
6	Single door all freezer model features
7	Built-in refrigerator model features
7	Built-in freezer model features
8	Installing your new appliance
10	Initial start up
10	Electronic display controls
10	– Controlling the temperature
11	– Fast freeze function
11	– Freezer temperature alarm
11	– Door alarm
11	– Child lock
11	– Drinks chill timer
11	– Eco mode
11	– Normal mode
12	– Vacation mode
12	– Other features
12	Manual (rotary) controls
12	– Controlling the temperature
13	Using your appliance
13	– Crisper bins
14	– Door storage bins
14	– Dairy compartment
14	– Chiller bin (where fitted)
14	– Bottle caddy
14	– Freezer baskets (built-in freezer only)
14	– Freezer drawers
15	– Spillsafe™ glass shelves
15	– Slide away glass shelf
15	– Deodoriser
15	– Bottle twist holder
16	– Ice station
16	Care and maintenance
16	– Changing the lightbulb
17	– Cleaning the appliance
18	Troubleshooting
19	Warranty

BEFORE USING YOUR APPLIANCE

Before you use the refrigerator, we recommend that you read through the relevant sections of this manual, which provides the description of your appliance and its functions.

To avoid the risks that are always present when you use an appliance, it is important that the appliance is installed correctly and that you read the safety instructions carefully to avoid misuse and hazards.

We recommend that you keep this instruction booklet for future reference and pass it on to any future owners.

IMPORTANT!

Check for any damage or marks
If you find the refrigerator is damaged or marked, you must report it within 7 days if you wish to claim for damage/marks under the manufacturer's warranty.
This does not affect your statutory rights.

INFORMATION ON DISPOSAL FOR USERS

ENVIRONMENT!

- Most of the packing materials are recyclable. Please dispose of those materials marked with the recycle symbol  through your local recycling depot or by placing them in appropriate collection containers.
- If you wish to discard this product, please contact your local authorities and ask for the correct method of disposal.
- Local authorities will have the latest information regarding safe disposal of the product.
- Incorrect disposal may expose the user to injury from sharp objects, flammable gasses or cause environmental damage.
- Refrigerant gasses within the unit should only be discharged by qualified persons. A licence may be required by your local authorities to discharge or reclaim the refrigerant gasses. Incorrect discharge of gasses may expose the user to injury from flammable gasses or cause environmental damage.

WARNING!

When you dispose of your old refrigerators or freezers remove any doors. Children can suffocate if they get trapped inside a discarded unit.

IMPORTANT SAFETY INSTRUCTIONS

WARNING!

- This appliance is not intended for use by persons (including children) with reduced physical, sensory or mental capabilities, or lack of experience or knowledge, unless they are being supervised or have been given instruction concerning use of the appliance by a person responsible for their safety. Children should be supervised to ensure that they do not play with the appliance.
- Don't use a steam cleaner. If live components come into contact with condensing steam, they may short circuit or cause an electric shock.
- Do not use mechanical devices or other means to accelerate the defrosting process other than those recommended by the manufacturer.
- This appliance contains insulation formed with flammable blowing gases. Avoid safety hazards by carefully disposing of this appliance.

R600a refrigerant warning

- This appliance contains flammable R600a refrigerant. Avoid safety hazards by carefully installing, handling, servicing and disposing of this appliance.
- Ensure that the tubing of the refrigerant circuit is not damaged during transportation and installation.
- In the event any damage accidentally occurs, keep the appliance away from open fires and any devices that produce sparks or arcs and luminaries during normal or abnormal operation, and unplug the appliance at the power point. Call authorised service for necessary action and advice.
- Leaking refrigerant may ignite vent area if leak occurs.
- The room for installing appliance must be at least 1m³ per 8g of refrigerant. The amount and type of refrigerant in the appliance can be found on the rating plate inside the appliance.
- It is hazardous for anyone other than an Authorised Service Person to service this appliance. In Queensland Australia - the Authorized Service Person MUST hold a Gas Work Authorisation for hydrocarbon refrigerants, to carry out servicing or repairs which involve the removal of covers.

Switching off your appliance

If the appliance needs to be switched off for an extended period, the following steps should be taken to reduce the symptoms of mould:

1. Remove all food.
2. Remove the power plug from the power point.
3. Clean and dry the interior thoroughly.
4. Ensure that all the doors are wedged open slightly for air circulation.

GENERAL WARNINGS

Read the following carefully to avoid damage or injury

⊘ **This symbol indicates never to do this**

⊙ **This symbol indicates always do this**

It is important to use your refrigerator safely.

Check these safety points before using your refrigerator.

⊙	The appliance must be plugged into its own dedicated 220-240V, 50Hz AC electrical outlet.
⊙	Ensure that the electrical outlet is properly earthed. Consult a qualified electrician if you are unsure.
⊙	If the power cord is damaged, it must be replaced by the manufacturer, its service agent or similarly qualified persons in order to avoid a hazard.
⊙	Check that the power cord can reach the power point. Don't plug your refrigerator into an extension cord or double adaptor.
⊙	Unplug the appliance before cleaning or moving.
⊙	Choose a location that is not too cold – the ambient temperature should be above 10°C.
⊙	Put the refrigerator in a dry place avoiding areas of high moisture or humidity.
⊙	Keep ventilation openings in the appliance enclosure or in the built-in structure clear of obstruction.
⊙	The plug to the appliance must be accessible when the unit is in the installed position.
⊘	Never unplug the appliance by pulling on the power cord. Always grip the plug firmly, and pull straight out of the receptacle to prevent damaging the power cord.
⊘	Don't plug your refrigerator into a timer fitted to the power point.
⊘	Do not put the refrigerator in frosty or unprotected areas, for example in a garage or on a veranda.
⊘	Do not put the refrigerator in direct sunlight, near stoves, fires or heaters.
⊘	Do not put the refrigerator on an uneven surface.
⊘	Do not store explosive substances such as aerosol cans with a flammable propellant in this appliance.
⊘	Do not use electrical appliances inside the food storage compartments of the appliance, unless they are of the type recommended by the manufacturer.
⊘	Never store fizzy drinks in the freezer compartment.
⊘	Never try to repair the refrigerator yourself, only use a qualified or authorised service person for repairs.
⊘	Never use electric heaters or dryers to defrost the freezer because you can receive an electric shock.
⊘	Do not damage the refrigerant circuit.

CAUTION

Automatic aerosol systems (such as insect control) should not be located adjacent to the product as the spray may cause long term damage to the external plastics of the appliance.

Note: You must read these warnings carefully before installing or using the refrigerator. If you need assistance, contact your Customer Care Department. The manufacturer will not accept liability, should these instructions or any other safety instructions incorporated in this book be ignored.

TOP MOUNT FREEZER MODEL (TM)

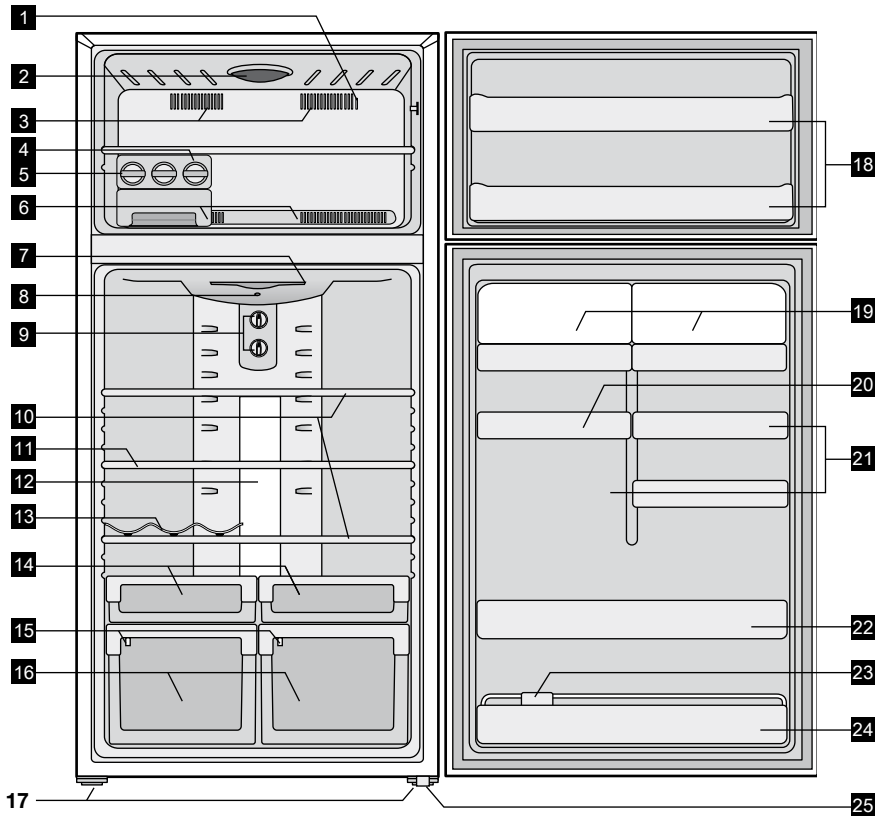

- 1 Sensor (electronic models only)
- 2 Freezer light (electronic models only)
- 3 Freezer air delivery vents
- 4 Adjustable Spillsafe™ glass shelf
- 5 Twist ice & serve with ice cube trays
- 6 Freezer air return vents
- 7 Sensor (electronic models only)
- 8 Deodoriser
- 9 Fridge and freezer temperature controls (manual control models)
- 10 Adjustable Spillsafe™ glass shelves
- 11 Spillsafe™ slide away shelf (where fitted)
- 12 Fridge light
- 13 Bottle caddy
- 14 Deli compartments (full width on some models)
- 15 Crisper humidity controls
- 16 Crisper bins (full width on some models)
- 17 Adjustable rollers
- 18 Freezer door bins
- 19 Dairy compartments
- 20 Egg tray
- 21 Adjustable door bins
- 22 Full width door bin
- 23 Bottle twist holder (where fitted)
- 24 Full width door bin (can bin on smaller models)
- 25 Stabilising foot

Note: Product illustrations demonstrate various features but may not be completely in line with current products.

BOTTOM MOUNT FREEZER MODEL (BM)

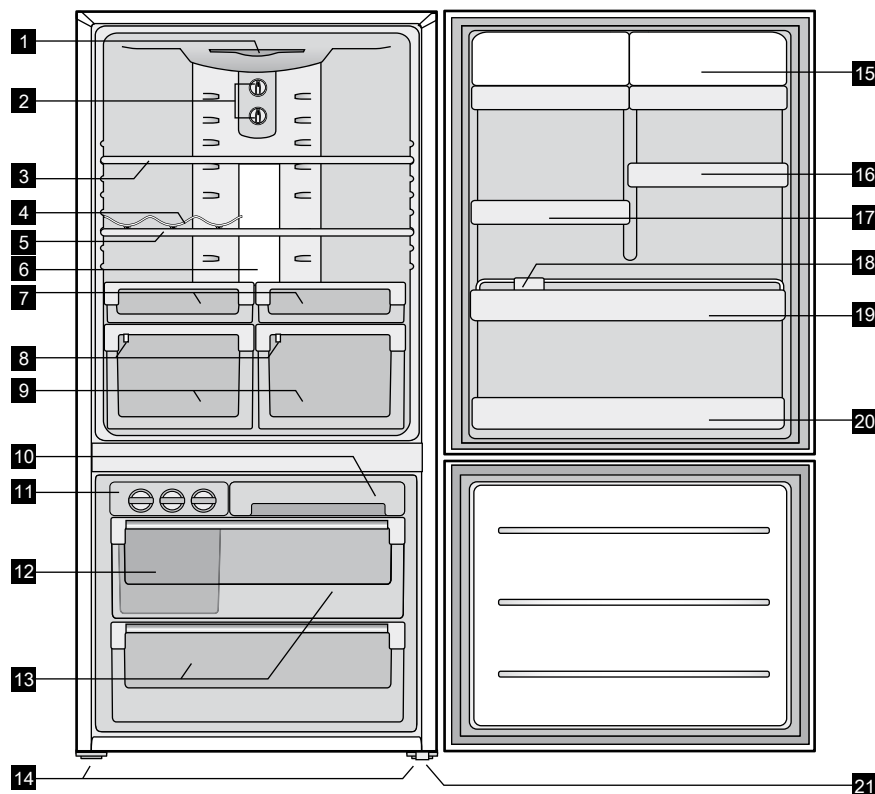

- 1 Deodoriser
- 2 Fridge and freezer temperature controls (manual control models)
- 3 Spillsafe™ slide away shelf (where fitted)
- 4 Bottle caddy
- 5 Adjustable Spillsafe™ glass shelf
- 6 Fridge light
- 7 Deli compartments (full width on some models)
- 8 Crisper humidity controls
- 9 Crisper bins (full width on some models)
- 10 Freezer storage tray
- 11 Twist & serve ice
- 12 Ice bin with scoop (inside freezer drawer)
- 13 Freezer drawers on telescopic extension slides
- 14 Adjustable rollers
- 15 Dairy compartments
- 16 Adjustable door bins
- 17 Egg tray
- 18 Bottle twist holder (where fitted)
- 19 Full width bottle bin
- 20 Full width bottle bin (can bin on smaller models)
- 21 Stabilising foot

Note: Product illustrations demonstrate various features but may not be completely in line with current products.

SINGLE DOOR ALL REFRIGERATOR MODEL (AR)

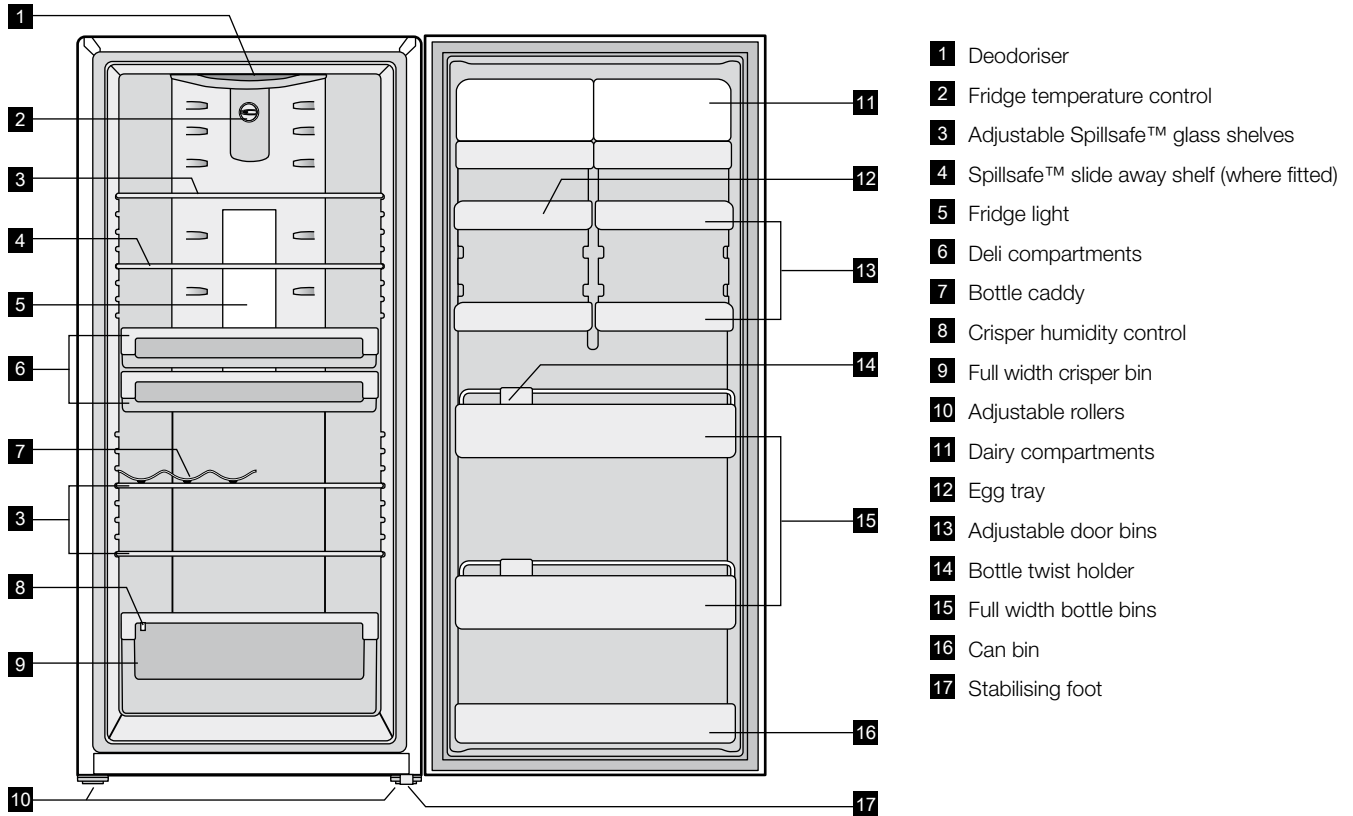

Note: Product illustrations demonstrate various features but may not be completely in line with current products.

SINGLE DOOR ALL FREEZER MODEL (AF)

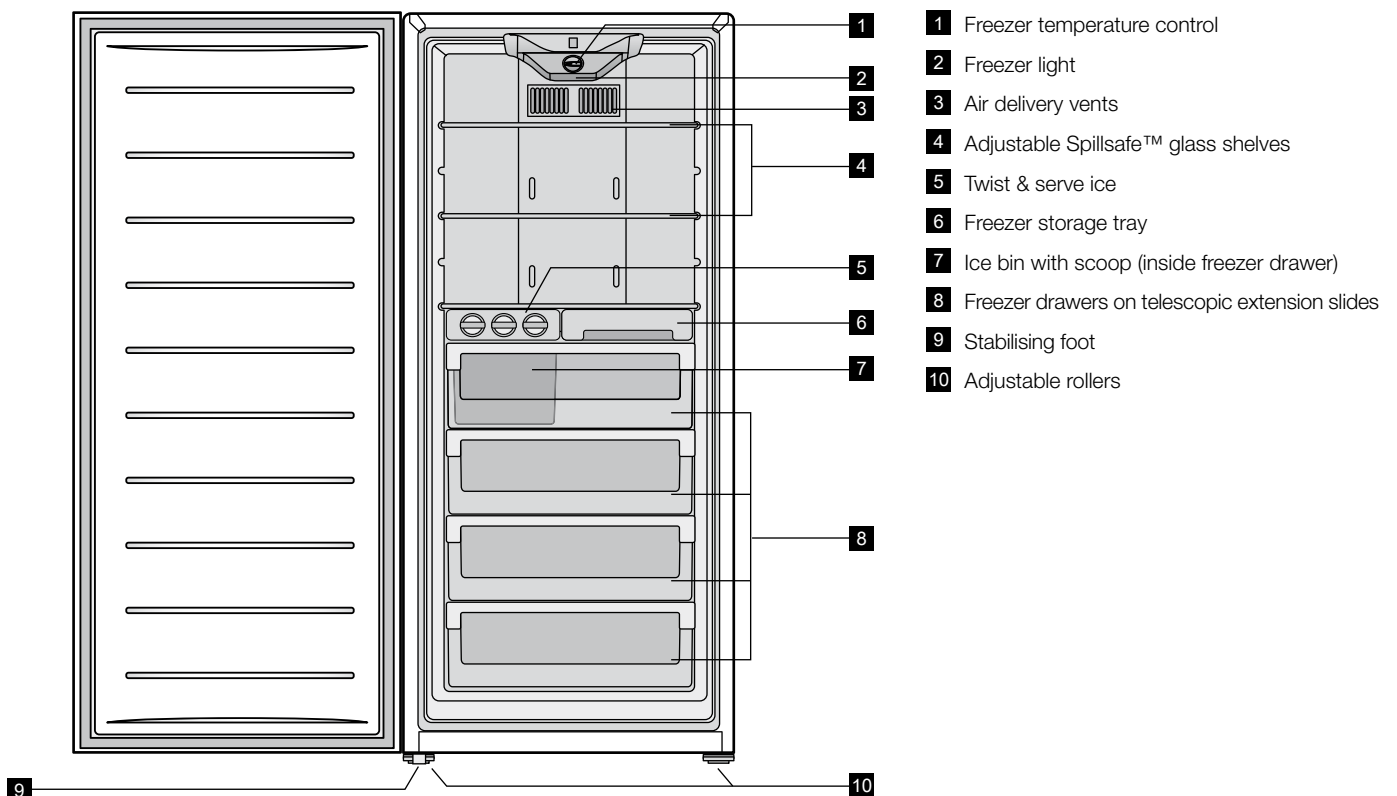

Note: Product illustrations demonstrate various features but may not be completely in line with current products.

BUILT-IN REFRIGERATOR

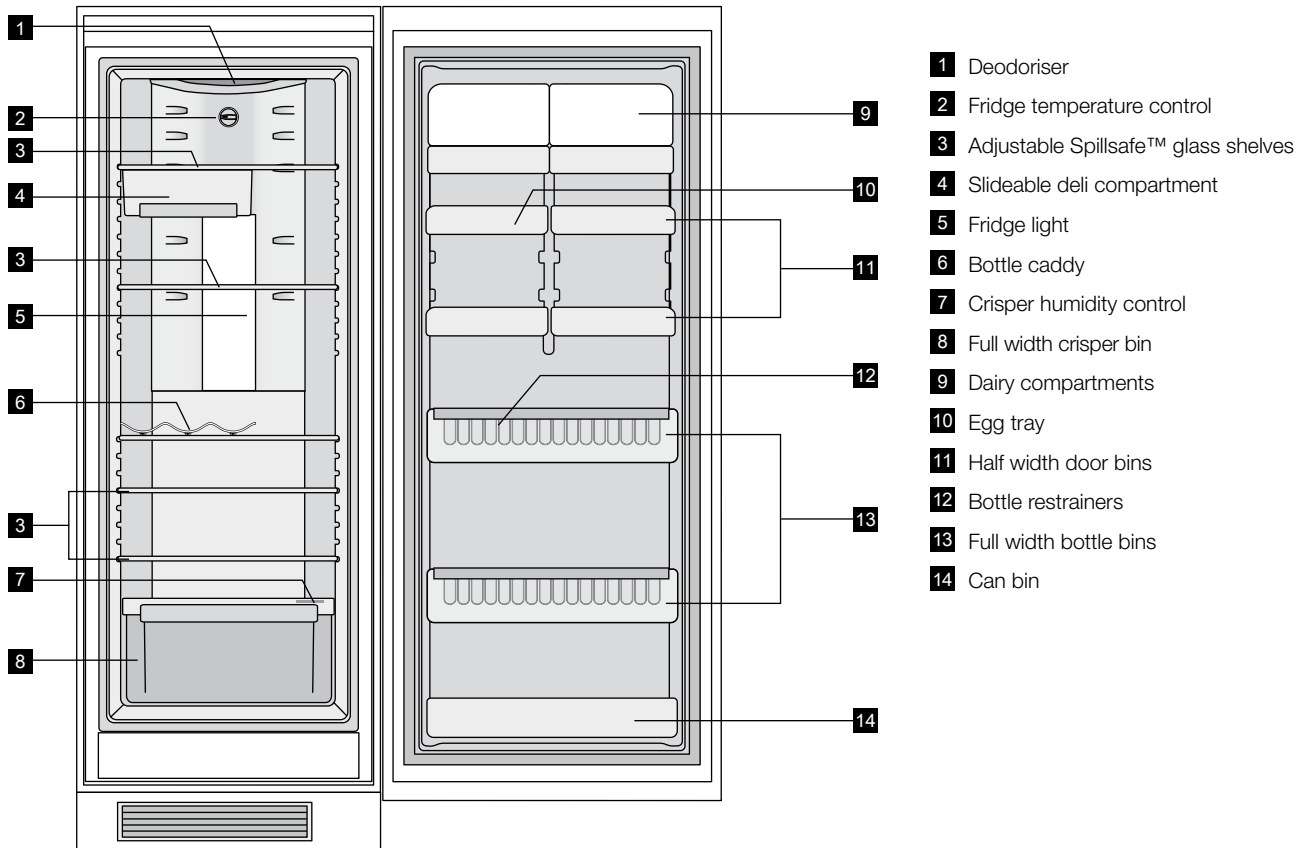

Note: Product illustrations demonstrate various features but may not be completely in line with current products.

BUILT-IN FREEZER

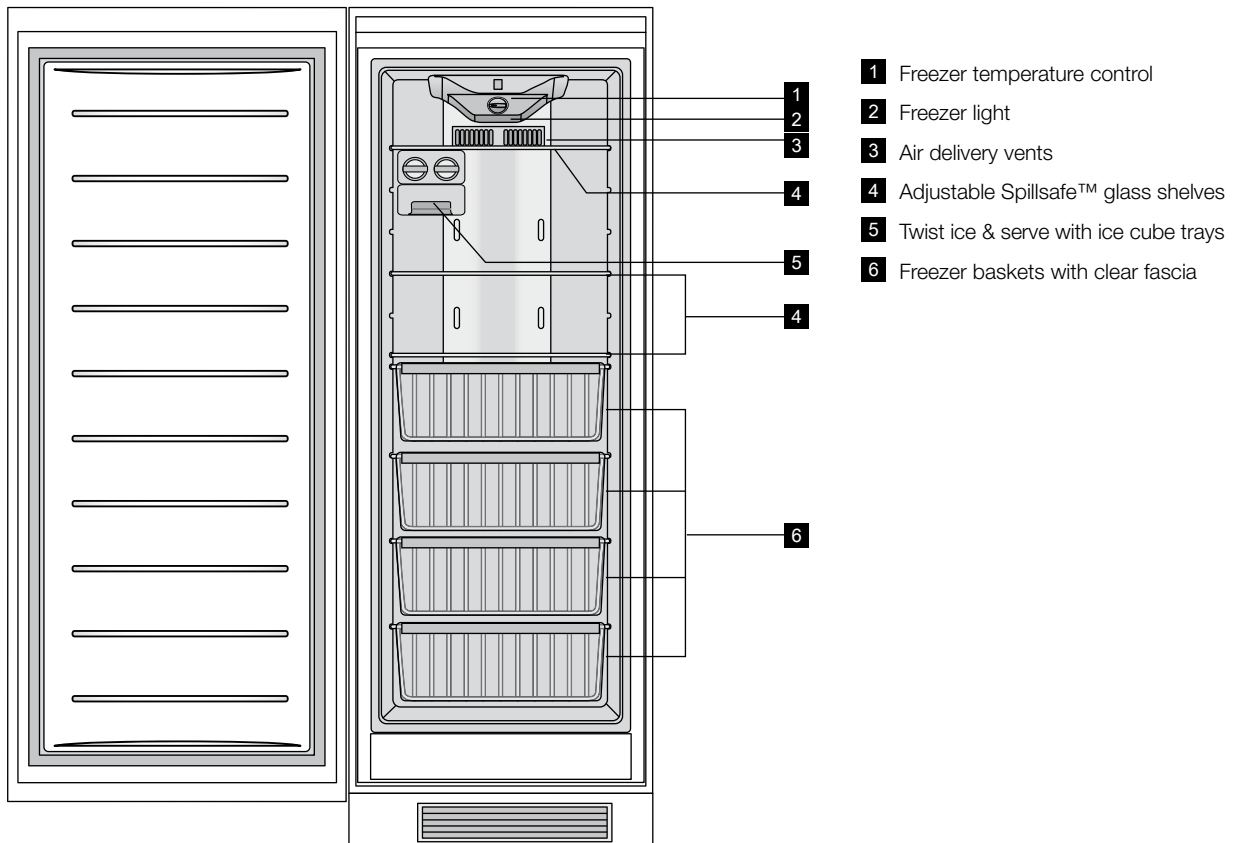

Note: Product illustrations demonstrate various features but may not be completely in line with current products.

INSTALLING YOUR NEW APPLIANCE

i TIPS & INFORMATION!

- For built-in models, refer to the separate booklet.
- To join two E:Line modular fridges together, refer to the booklet with the connection kit.

Adequate ventilation around your refrigerator.

The diagram below shows the recommended airspace to allow for ventilation of your refrigerator.

If you don't have a cupboard with a rear gap, the recommended clearance area on top increases from 50mm to 90mm (x) and from 32mm to 72mm (y). When positioned in a corner area, spacing of at least 350mm on the hinge side will allow the doors to open enough to enable the removal of bins and shelves.

Note: For those models with telescopic extension slide-out bins, the clearance required increases from 350mm to 550mm for top mount and bottom mount models, and to 450mm for the all refrigerator model to allow full access to the bins' contents as well as bin removal.

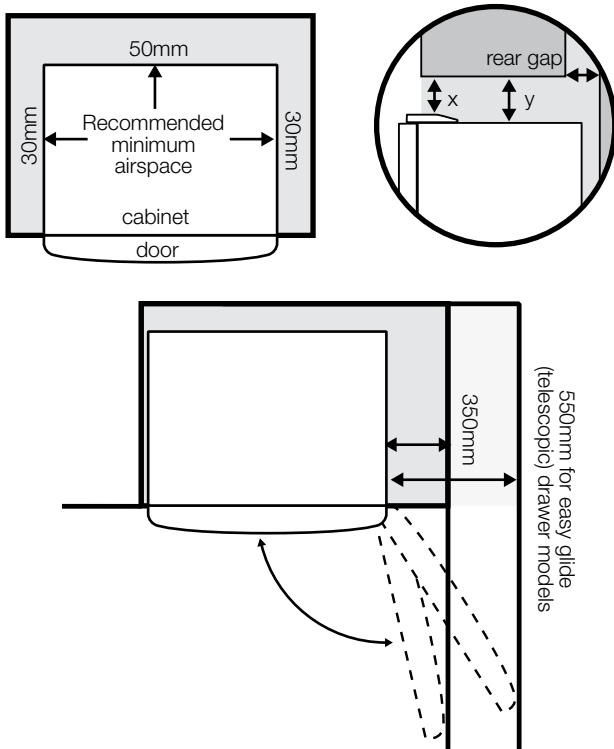

NOTE: Doors are designed to sit proud of cabinetry (not flush). The clearances shown above are the recommended minimum clearances. The clearance at the rear must not exceed 75mm.

Installing your refrigerator

Your new refrigerator should arrive with the front adjustable rollers wound down, to tilt the top backwards by about 10mm from upright. This will allow your refrigerator door to self-close, providing a consistent closed seal.

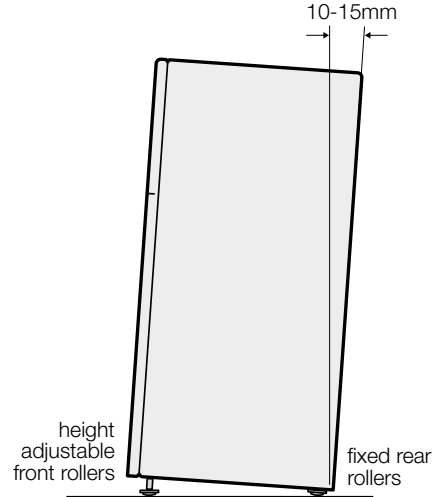

The stability foot should also be wound fully up so it will not interfere with the operation of the rollers (see diagram in Step 3).

! CAUTION!

The rollers are designed for forward or backward movement only. They are not castors. Moving the refrigerator sideways may damage your floor and the rollers.

1. Roll the refrigerator into place.
2. The top of the refrigerator should be tilted back by 10mm (see diagram on left). This will allow the doors to self-close providing a consistent door seal.
3. If the refrigerator isn't tilted back, you can adjust the two front rollers by turning the large, plastic roller nut. (see diagram below). One turn of the nut increases the height of the refrigerator by 10mm. If you have difficulty turning the roller nut, have someone tilt the refrigerator back, so you have better access. Alternatively, you can access the rollers from the side, using a flat screwdriver. (See diagram below).

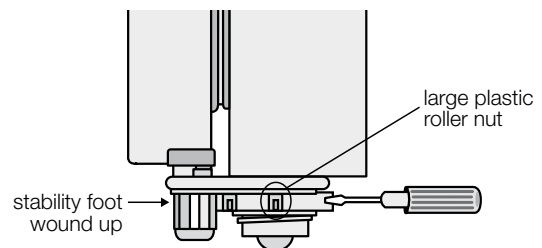

INSTALLING YOUR NEW APPLIANCE

4. Check the alignment of the refrigerator to the surrounding cupboards to see if it is level. You can adjust the level with the rollers as detailed in step 3.

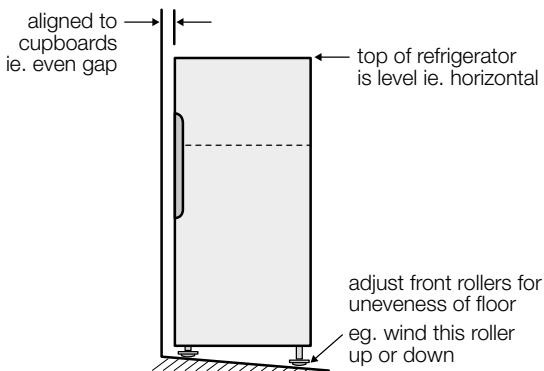

5. If you find your refrigerator rocks from corner to corner, it means your floor is uneven. Find a piece of plastic or hardboard etc. and pack it firmly under the roller.
6. On certain floor surfaces the refrigerator may roll forward during operation. Where provided a "Roller Stop" can be placed under the front rollers. If roller stop is required, please contact Customer Service (details on back page) and quote part no. 1448845.

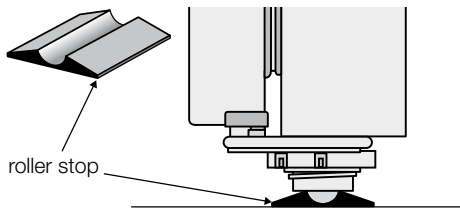

7. You may now need to fine-tune the installation by repeating Steps 3, 4 and 5.
8. When you have the appliance in its final position, it needs to be stabilised. Wind the stability foot down to the floor until it just makes contact with the floor. Lift the front of the appliance to take the weight off the stability foot, then turn it $\frac{1}{4}$ turn further to ensure firm contact with the floor. Whenever you need to move the appliance, be sure to wind the foot back up so that the appliance can roll freely and be sure to reset it when reinstalling.

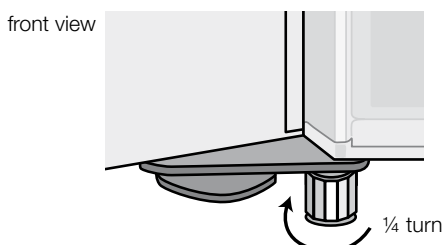
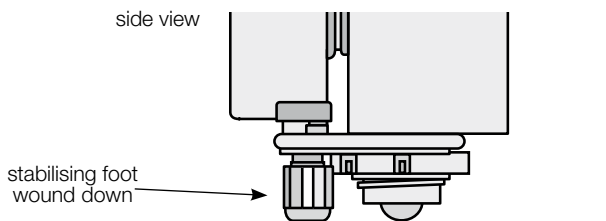

9. Clean your refrigerator thoroughly following the instructions on page 15 and wipe off any dust that has accumulated during shipping.
10. Plug your refrigerator straight into its own power point and never use a double adapter. If you need to roll the refrigerator to get to the plug, remember to raise the stability foot first.
11. Before you put any food in your refrigerator, it's recommended you leave it on for 2 or 3 hours to check it is running properly.

Congratulations! You have successfully installed your new refrigerator.

i TIPS & INFORMATION!

For built in models, the plug must be accessible after installation.

INITIAL START-UP

Refrigerators work by transferring heat from the food inside to the outside air. This operation makes the back and sides of the refrigerator (particularly at start-up) feel warm – which is normal.

A cooling coil is located behind the rear wall of the freezer section (in top mount, bottom mount and freezer models) and behind the crisper in the all-refrigerator models. This coil cools and removes moisture from the air inside.

Avoid placing food against the air vents in the refrigerator, as it affects the efficient circulation. If the door is opened frequently, a light frosting will occasionally occur on the freezer's interior. This is normal and will clear after a few days. If the freezer door is accidentally kept open, a heavy frost will coat the inside walls and should be removed.

Your new refrigerator uses a high-speed compressor, along with other energy-efficient components, which may make unusual sounds. These sounds simply indicate your refrigerator is working how it should. They include:

- Compressor running noises;
- Air movement noise from the small fan motor;
- A gurgling sound, similar to water boiling;
- A popping noise, heard during automatic defrosting;
- A clicking noise, prior to compressor start-up.

Further details can be found on page 17.

i TIPS & INFORMATION!

- **Don't place food forward of the ribs on the freezer floor in top mount refrigerators (where the freezer is on top of the fresh food compartment), as this will keep the door from closing properly.**

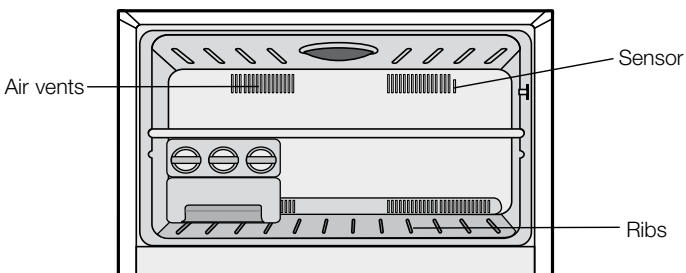

- For bottom mount refrigerators (where the freezer is below the fresh food compartment), single door refrigerators and single door vertical freezers.
 - Ensure all freezer drawers and shelves are pushed back completely to prevent them from keeping the door open.

ELECTRONIC DISPLAY CONTROLS

The electronic display panel consists of an LCD display with black backlighting and 6 touch buttons. When the power is first turned on, the display with backlighting will come on.

If no buttons have been pressed and the fridge door is closed the backlighting will turn off after 30 seconds.

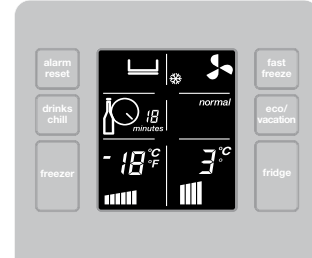

NOTE: If no buttons have been pressed for approximately 60 seconds, there may be a delay of up to 2 seconds before the display reacts. This is normal and is to prevent accidental changes to settings.

Controlling the temperature

We recommend that when you start your refrigerator for the first time, the temperature for the refrigerator is set to 3°C and the freezer to -18°C. If you want to change the temperature, follow the instructions below. Make only small adjustments and wait 24 hours to see if it's correct. Checking the softness of ice cream is a good indication if your freezer is the right temperature, while checking the temperature of water kept in the refrigerator is a good way of checking the temperature of the food compartment.

NOTE: When you set a temperature, you set an average temperature for the whole refrigerator cabinet. Temperatures inside each compartment may vary, depending on how much food you store and where you place it. High or low room temperature may also affect the actual temperature inside the refrigerator.

Changing the freezer temperature

Press the freezer button to make the freezer colder in 1°C steps. Once the maximum of -23°C is reached, the display will return to -14°C with the next press of the button. The bar graph gets smaller with colder freezer settings.

Changing the refrigerator temperature

Press the fridge button to make the refrigerator colder in 1°C steps. Once 0°C is reached, the display will return to 7°C with the next button press. The bar graph gets smaller with colder refrigerator settings.

ELECTRONIC DISPLAY CONTROLS

Fast freeze function

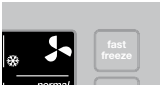

Use the fast freeze function when you add a large amount of food to the freezer compartment. This freezes the food quickly but does not affect the temperature in the refrigerator compartment. To use this function, press the fast freeze button once. An animated icon will light up. The freezer compartment temperature will change to -23°C and operate for 90 minutes. If you want to turn the fast freeze function off before 90 minutes have passed, simply press the fast freeze button again. The icon will disappear and the freezer will return to normal operation.

Freezer temperature alarm



If the alarm sounds for no apparent reason, check whether anything is keeping the door open. If the freezer becomes too warm due to the freezer door being left open or warm food being placed too close to the temperature sensor, a buzzer will sound.

The icon adjacent to the alarm reset button, the freezer set temperature and bar graph will all flash, until the alarm reset button is pressed. Once pressed, the alarm disable icon adjacent to the alarm button will illuminate for 50 minutes, or until the temperature drops to an acceptable level. Make sure nothing is holding the freezer door open and move any warm food away from the temperature sensor. If the freezer is still too warm after 50 minutes, the alarm will sound again, indicating that something may be wrong with the refrigerator.

NOTE: The freezer temperature alarm can be reset for 12 hours by pressing the alarm reset button continuously for 10 seconds.

Door alarm

If the fridge door or freezer door (where freezer light fitted) is left open for more than two minutes, the alarm will buzz and an arrow pointing to an open door will flash, along with the temperature setting and bar graph. If you want to leave the door open while you load the refrigerator, you can turn the alarm off for 8 minutes by pressing the alarm reset button.

If the fridge door or freezer door (where freezer light fitted) is left open for more than 15 minutes, the light will dim to 50% brightness. If the door is left open for a further 15 minutes, the light will automatically turn off to save energy. To turn the light back on simply close and reopen the door.

Child Lock

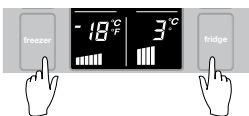

Press and hold the freezer and fridge buttons together for 3 seconds to activate the child lock.

This will disable the display to prevent accidental changes to settings. To turn the child lock off, press and hold the freezer and fridge buttons together.



Drinks chill timer



The drinks chill timer is used to quickly chill a bottle. Place the bottle in the freezer and the timer can be set for a minimum of 5 minutes to a maximum of 30 minutes. To set, simply press the drinks chill button repeatedly for the number of minutes (in 5-minute intervals). Once set, an animated icon appears beside the drinks chill button, with a timer that counts down one minute at a time.

You can change the time or turn the timer off even after the countdown has started. A buzzer will tell you when the time is finished and the icon will flash until the alarm reset button is pressed.

If your drink is not cold enough, reset the drinks chill function (remembering the drink is already partially chilled). Suggested chilling times:

- 10 minutes for cans of drink
- 20 minutes for bottles of wine
- 30 minutes for bottles of soft drink.



WARNING!

Ensure that bottles are not left in the freezer for longer than needed as freezing may cause the bottle to break.

Energy efficiency

Your refrigerator has been designed to be energy-efficient and can be operated in three modes: Eco, Normal and Vacation.

• Eco mode

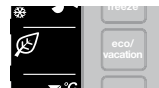

Eco mode is the default mode of your refrigerator. The leaf icon will automatically appear on the electronic display when your refrigerator is operating in eco mode.

• Normal mode

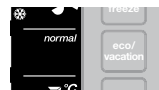

Normal mode is used when you require extra cooling for your storage or when the refrigerator door is often opened.

The 'normal' text will automatically appear on the electronic display when your refrigerator is operating in normal mode.

Normal mode is activated when:

- The freezer compartment temperature setting is colder than -18°C
- The fresh food compartment temperature setting is colder than $+3^{\circ}\text{C}$
- The fast freeze function is activated.
- The door alarm is activated.
- The freezer temperature alarm is activated.

ELECTRONIC DISPLAY CONTROLS

• Vacation mode



Use this button when you go on vacation or leave the house for long periods of time. The refrigerator goes to default setting temperature (-18°C, +3°C) if the temperature was set colder than the default temperature and minimizes defrosting to save energy. To put the refrigerator into vacation mode, press the eco/vacation mode button once.

An aeroplane icon will appear. The vacation mode will operate until the button is pressed again or the refrigerator door is opened. The refrigerator will revert back to operate at your previous setting.

NOTE: Opening the freezer door won't effect the operation of eco, normal and vacation modes.

Other special refrigerator features (electronic models only)

- Independent control of the compressor and fan to provide the best performance.
- Extra cooling depending on the number of times the door is opened.
- Automatic defrost when the door is not frequently opened.

NOTE: Display malfunctions may be due to brief power supply interruptions. If this occurs, turn the refrigerator off at the power point and wait 5 minutes. The refrigerator pressure will need time to equalise before you turn the refrigerator on again.

MANUAL (ROTARY) CONTROLS

Controlling the temperature

Set the temperature by using the main temperature controls at the rear of the refrigerator compartment. When you first start your refrigerator, set both refrigerator and freezer controls to MID.

i TIPS & INFORMATION!

A good indication of optimal freezer temperature is ice cream that is frozen, but still soft enough for easy scooping.

For the fridge compartment, we recommend using drinking water and simply adjusting the fridge controls until the water is at your ideal temperature.

Changing the settings

When you change temperature settings, make small adjustments and wait 24 hours before assessing whether you need to make any further changes.

i TIPS & INFORMATION!

Coldest freezer setting is not recommended in normal and very hot climates as this will limit the cooling to the refrigerator section.

- In very cold climates (where temperatures are below 10°C) the freezer may need to be set colder.
- **Adjusting the freezer temperature – top mount freezer (TM) model**
 1. Select the freezer control (top knob).
 2. Rotate the knob clockwise to set colder.
 3. Rotate the knob anti-clockwise to set less cold.

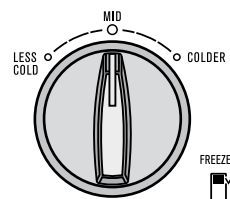

- **Adjusting the refrigerator temperature – top mount freezer (TM) model**

1. Select the refrigerator control (bottom knob).
2. Rotate the knob clockwise to set colder.
3. Rotate the knob anti-clockwise to set less cold.

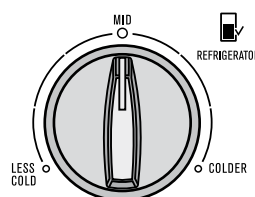

MANUAL (ROTARY) CONTROLS

- **Adjusting the refrigerator temperature – bottom mount freezer (BM) model**

1. Select the refrigerator control (top knob).
2. Rotate the knob clockwise to set colder.
3. Rotate the knob anti-clockwise to set less cold.

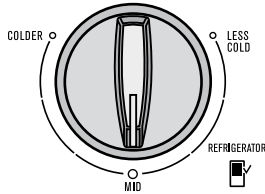

- **Adjusting the freezer temperature – bottom mount freezer (BM) model**

1. Select the freezer control (bottom knob).
2. Rotate the knob clockwise to set colder.
3. Rotate the knob anti-clockwise to set less cold.

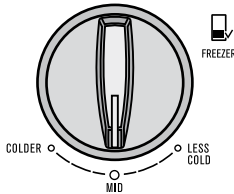

- **Adjusting the all refrigerator temperature – single door all refrigerator (AR) built-in refrigerator models**

1. Rotate the knob clockwise to set colder.
2. Rotate the knob anti-clockwise to set less cold.

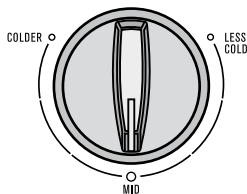

- **Adjusting the all freezer temperature – single door all freezer (AF) and built-in freezer model**

1. Rotate the knob clockwise to set colder.
2. Rotate the knob anti-clockwise to set less cold.

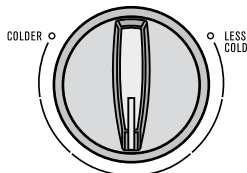

USING YOUR APPLIANCE

Crisper bin

Use the crisper bin to store vegetables, fruit or small goods. Change the humidity by sliding or rotating the humidity control.

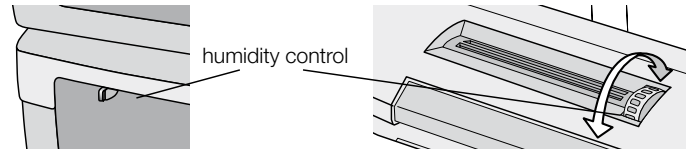

- **Storing vegetables**

Store vegetables in the crisper bin and remember to set the humidity control to more humid (closed).

- **Storing fruit & small goods**

Store fruit and small goods in the crisper bin and remember to set the humidity control to less humid (open).

- **Removing standard crisper bins**

1. Empty food from the drawer.
2. Remove the crisper bin(s) by pulling forward, then up and forward again.
3. Remove the crisper shelf by lifting the catches on the underside of the shelf and pulling the shelf forward.

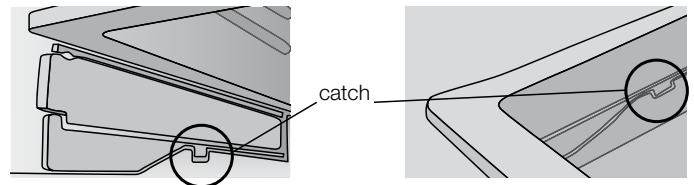

- **Removing bins with telescopic extension slides**

Remove the crisper bin(s) by pulling forward, then up and forward again, lifting the bin off the slides. Push the slides back into the refrigerator.

! CAUTION!

Never close the door while the telescopic slides are extended. It may damage the slide and/or the refrigerator or cause the slide to become disengaged from the refrigerator.

! CAUTION!

To clean a crisper cover with telescopic extension slides, simply wipe with a damp cloth and warm soapy water. Never immerse the cover in water, as this could affect the operation of the slide.

USING YOUR APPLIANCE

• Replacing bins with telescopic extension slides

1. Ensure that the telescopic slides are pushed in all the way.
2. Slide the bin into place over the slides and push in until it stops. The bin will not be closed all the way.
3. Open the bin to access the finger tabs at the ends of the telescopic slides, on each side of the bin. Using your thumb and forefinger, lift the bin over the end of the slide and clip in place. If the bin is not fully engaged on the slide, it may not stay on the slide when fully extended.

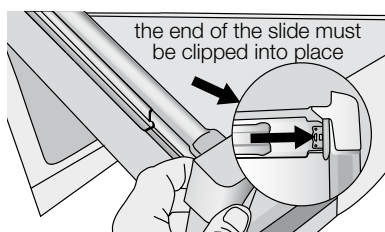

4. Fully close the bin.

When replacing the drawers after cleaning, we recommend fitting the lower drawer first.

Door storage bins

The top mount models, bottom mount freezer model and all refrigerator models are fitted with door storage bins. These bins adjust to meet different storage needs. All the door bins are completely removable for cleaning. If you want to remove or adjust a bin, lift it over the support lugs on the inner door panel. To replace, push the bin down over the support lugs to lock it in place.

Dairy compartment

Use the dairy compartment to store foods like butter, margarine and cheeses. The compartment is slightly warmer than the rest of the refrigerator compartment, while the lid provides protection against odours.

Chiller bin (where fitted)

Use the chiller bin to store foods like small goods, fresh or cooked meat and cheese, or as an additional crisper. The bin will prevent strong food odours from creeping into the rest of the refrigerator. To remove the chiller bin, pull it forward, then lift it up and pull it further forward.

Bottle caddy

The bottle caddy is made of stainless steel. It is used to store various types of bottles like wine or beer. Bottles should be stored with the bottom end towards the back of the refrigerator.

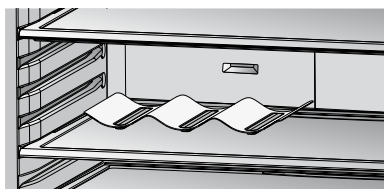

Freezer baskets (built-in freezer only)

Freezer baskets and a freezer shelf are fitted to built-in freezers. Wire baskets are used to provide easy visibility of the contents. Both the baskets and the shelf pull out for easy access and have a stop to prevent the basket and shelf being pulled out too far.

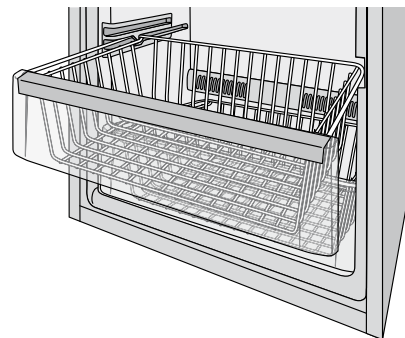

To remove the basket or shelf, pull it out until it hits the stop then lift the front to unhook the stop while continuing to pull forward.



Freezer drawers

Freezer drawers are fitted to bottom mount models and single door all freezer models. The drawers are mounted on telescopic extension slides, to enable full access to the content in the drawer. Clear plastic fronts provide easy visibility of foods.

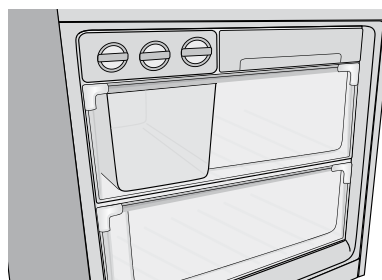

- To remove the drawer for cleaning,
 1. Empty food from the drawer.
 2. Remove the drawer by pulling it forward and lifting the front to unhook it from the slides. Once you have removed the drawer, ensure the slides are pushed back so they are fully closed.

USING YOUR APPLIANCE

Spillsafe™ glass shelves

Spillsafe™ glass shelves keep spills on the shelf. A shelf retaining system minimises accidental movement of shelves and they can be adjusted to various heights. Spillsafe™ glass shelves are not to be used as slide out shelves. To remove the shelves, gently pull them forward until the shelf comes clear of the shelf guides. To return the shelf, make sure there is nothing behind that may obstruct movement. Gently push the shelf into the cabinet and back into position.

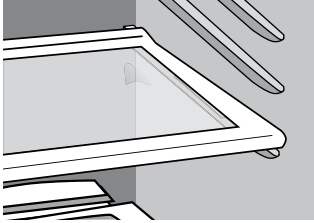

Slide away glass shelf (where fitted)

This shelf can be used either as a full depth shelf or when tall items need to be stored at the front of the appliance it can be collapsed to half its original depth.

• Collapsing the shelf

1. Pull the front half of the shelf forward.

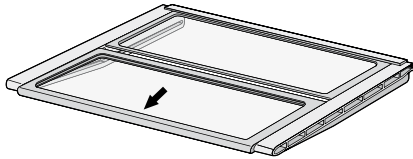

2. Then, from the underside, lift the front half of the shelf by raising the rear edge over the recessed hook detail.

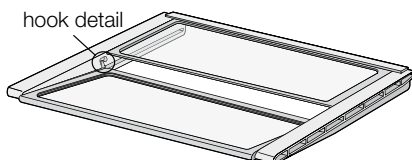

3. Pull the shelf forward and allow the rear to drop into the side channels.

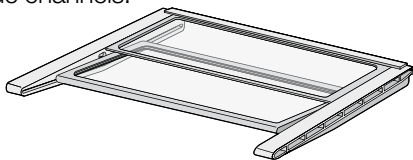

4. Push the front shelf backwards (3,4) until it reaches the rear stops.

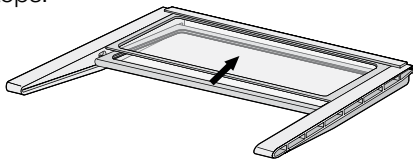

• Repositioning the shelf

The shelf can be repositioned within the appliance unit by pulling the whole assembly out until the side panels are free to pivot down, then pivoting the rear of the shelf until the shelf is free from the liner runners. The shelf can then be positioned in any of the runners.

This is a very useful feature if your appliance door happens to have limited access.

Deodoriser (where fitted)

Your appliance is fitted with a deodoriser to assist with the removal of food odours inside your appliance.

Odours are removed by absorption through the filter by the normal operation of the appliance. Keeping food covered and wrapping food with plastic wrap will also help to reduce the odours inside your appliance.

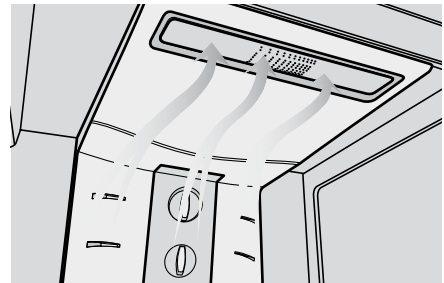

Bottle twist holder operation (where fitted)

The bottle twist holder is used to prevent bottles from falling over. The bottle twist holder consists of two parts, a sliding front, and a rotating retainer ring.

The bottle twist holder can be used in two positions:

• Horizontal

When the bottle twist holder ring is horizontal, any item that fits within the ring can simply be placed inside it.

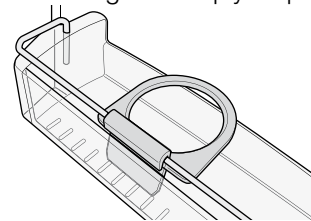

• Vertical

When the bottle twist holder ring is vertical, it is possible to simply slide the bottle twist holder along the bottle retainer bar until it is pushed up against a bottle.

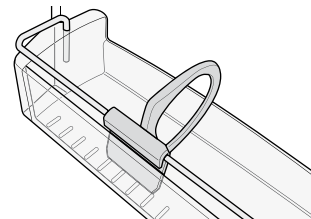

Note: The bottle should be constrained on the other side by either the end of the bin or other adjacent bottles.

USING YOUR APPLIANCE

Twist ice & serve (where fitted)

Top mount, bottom mount and single door all vertical freezer models have a twist ice & serve ice cube tray assembly.

To use, remove the tray, fill with water and place back in the freezer. Once ice has formed (approximately 3 hours) simply twist the knob at the front clockwise until the ice drops into the bin below.

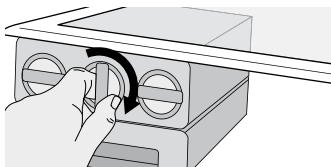

A larger bin is provided in some bottom mount models along with an ice scoop.

Ice station

Mounting the twist & serve ice to the other side of the freezer (top mount and built-in freezer models only)

1. Remove the ice bin and ice cube tray. If the ice tray assembly is frozen to the carriage, simply squeeze the tray and shelf together to break the ice.
2. Before you remove the ice carriage, remember to disengage it from the glass shelf (as shown), as it may result in damage to the assembly.

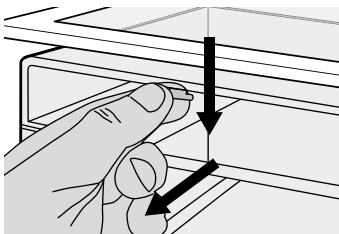

3. Remove the centre runner by disengaging it at the front of the shelf, and removing it from the rear.
4. Refit the runner in to the rear of the shelf on the right hand side and then engage the front (as shown).

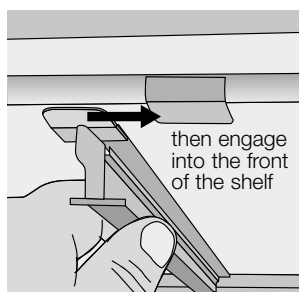
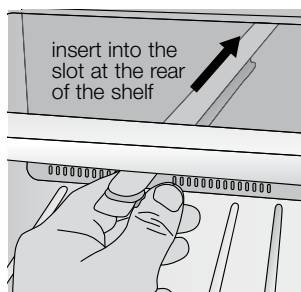

5. Fit the carriage by sliding it into the runners until the front of the carriage engages with the shelf.
6. Refit the ice tray and ice bin.

CARE AND MAINTENANCE

Changing the light bulb - Manual models



WARNING!

Before changing any light bulb, switch the power off at the power point and remove the power cord from the power point.

Refrigerator light

1. Switch off the power at the power point and remove the refrigerator's power cord from the power point.
2. Remove shelves.
3. Using a flat blade screwdriver, push clips down while pulling the lens forward. Carefully unclip the light cover. You do this by pulling the upper part of the cover towards the front of the cabinet.

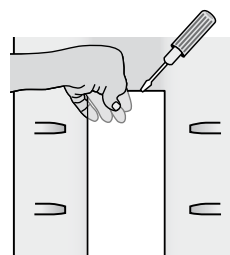

4. Unscrew the light bulb and replace it with a bulb that is the same as the original. If, when you remove the light bulb the small rubber "O" ring comes out with the bulb, fit the "O" ring over the new bulb and screw bulb into the socket (see diagram below).



WARNING!

Never insert your finger into the light bulb socket to check for the presence of the "O" ring.

5. Replace the light cover by hooking the light cover lugs into the bottom of the housing and pressing the upper part of the cover until it clips in.
6. Replace shelves.
7. Wait 5 minutes to ensure pressures in the refrigeration system are equalized. Then reconnect and turn the refrigerator on at the power point.



TIPS & INFORMATION!

Ensure the 'O' ring is in place before replacing the bulb.

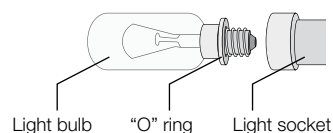

LED lighting - Electronic models

Your refrigerator is fitted with long life LED lighting. In the unlikely event the LED lights should fail, then the LED lights should be serviced by the manufacturer, it's service agent or similarly qualified technician. Refer to the warranty page for contact details.

When the door is left open for 15 minutes, the LED light will dim to 50% brightness to conserve energy and prolong the life of the LED. If the door is left open for a further 15 minutes, the light will automatically turn off. Close and reopen the door again to turn the light back on.

CARE AND MAINTENANCE

Cleaning the appliance

WARNING!

Before cleaning: Turn appliance off at the power point, then remove power cord from socket. This will make sure there is no chance of getting an electric shock.

Doors and exterior – stainless steel

Your stainless steel appliance is manufactured from a mark resistant stainless steel. This stainless steel has a special advanced protective coating that eases the removal of marks such as finger prints and water spots. To keep your stainless steel appliance looking at its best, you should clean it regularly. You should only clean the stainless steel doors with luke-warm soapy water and a soft cloth, rinsing with clean water and then wipe the surface with clean water and a soft clean cloth to remove soap residue.

It is important to wipe in the direction of the grain of the stainless steel to avoid undue marking of the surface.

- **Doors – surface hardened acrylic**

You should only clean the acrylic doors with lukewarm soapy water and a soft cloth, rinsing with clean water and the wipe the surface with clean water and a soft clean cloth to remove soap residue.

CAUTION!

Never use hot water, solvents, stainless steel cleaners, commercial kitchen cleaners, aerosol cleaners, metal polishes, caustic or abrasive cleaners, or scourers to clean this appliance, as they will damage it. Many commercially available cleaning products and detergents contain solvents that will damage your refrigerator. When cleaning, use only a soft cloth with an unscented mild soap and lukewarm water.

- **Interior**

You should clean the appliance interior regularly. It will be easiest to clean when the food supply is low. Wash the interior with a soft cloth and use an unscented mild soap with lukewarm water. Thoroughly dry all surfaces and removable parts. Avoid getting water on appliance controls. If you have taken out any removable parts, replace them and switch the power on before restocking the appliance with food. Naturally, you should keep the interior of your appliance hygienic by promptly and thoroughly wiping up any food spills.

Don't use a steam cleaner. If live components come into contact with condensing steam, they may short-circuit or cause an electric shock.

- **Door seals**

Take care to keep door seals clean. Sticky food and drink can cause seals to stick to the cabinet and tear when you open the door. Wash seal with a mild detergent and warm water. Rinse thoroughly and dry.

TROUBLESHOOTING

If you think something may be wrong with your refrigerator, you can carry out some easy checks before calling for service. You may locate the problem, sparing yourself from inconvenience, saving time and money.

problem	solution
Refrigerator is not operating	<ul style="list-style-type: none"> • Check that the power cord is plugged into the power outlet properly and that the outlet is switched 'ON'. • Try running another appliance from the power outlet. If no power is coming from the outlet you may have blown a fuse or tripped a circuit of your household power supply. • Try adjusting the temperature control to a slightly "colder" position. • It is normal for the freezer fan NOT to operate during the automatic defrost cycle, or for a short time after the appliance is switched on.
When there is refrigerator/freezer noise	<p>Modern refrigerators/freezers with increased storage capacity use high speed compressors. These can provide a seemingly high level of sound which is quite normal. Normal operational sounds include:</p> <ul style="list-style-type: none"> • Occasional gurgling, similar to water boiling. • Air flow noise (air circulates because of a small fan). • A popping noise heard during automatic defrost. • A clicking noise heard just before the compressor starts (this is just the automatic switching action of the temperature control, turning the compressor on or off). <p>Other strange sounds may mean that you need to check and take action. For example, noises may mean that:</p> <ul style="list-style-type: none"> • The cabinet is not level. • The floor is uneven or weak. • Bottles are badly placed and rattling. • There are vibrations from an object on top of or behind or beside the refrigerator. • The back of the refrigerator cabinet is touching the wall. <p>Remember it is quite normal for noise to seem louder just after the refrigerator starts operating.</p>
If there are odours inside the refrigerator	<ul style="list-style-type: none"> • The interior may need cleaning. • Some foods produce odours. • Some containers and wrapping can cause odours. • Ask yourself if the odour started about the same time you started storing something unusual.
If the electronic controls do not respond.	If no buttons have been pressed for approx. 60 seconds there may be a delay of up to 2 seconds before the display reacts. This is to prevent accidental changes to settings.
When the motor seems to run more than expected	<p>Your new refrigerator has a large fridge and freezer section to keep cool. So it is normal to frequently hear the sound of the motor. However, to keep operation to a minimum check the following:</p> <ul style="list-style-type: none"> • Are doors kept open too long or too often? • Are controls set too cold? See 'Controlling the temperature' on pages 9 – 10. • Have large amounts of warm food just recently been stored? Summer, festive seasons and holidays usually mean a lot more work for your refrigerator. • If the day is hot or the room is very warm, the refrigerator will need to run more than normal. • The refrigerator will run more than normal just after you install it or when it has been turned off for a long time.
If the temperature in the refrigerator is too warm	<ul style="list-style-type: none"> • Check that the appliance has enough clearance at the sides, back and top. Refer to the installation instructions on page 2. • Refer to 'Controlling the temperature' on pages 9 – 10. • You may have kept the door open too long or too frequently. • Food containers or packaging may be holding a door open.
If the temperature in the refrigerator is too cold	<ul style="list-style-type: none"> • Refer to 'Controlling the temperature' on pages 9 – 10. • Increase the temperature to avoid high energy consumption.
If heavy frosting occurs in the freezer	Make sure you fully close the freezer and fridge doors. If the doors are left open, a heavy frost will coat the inside of the freezer. If a frost develops, remove it and take care to properly close the doors.
If water drips on the floor	The defrost water tray, (located at the back or underneath of the cabinet) may not be properly positioned, or the drain tube may not be properly positioned to direct water into this tray. You may need to pull the refrigerator away from the wall to check the tray and tube.
Fridge does not exit vacation mode	Turn appliance off at the power point. Leave off for three (3) minutes for the memory to clear, then turn back on.
If the doors will not close	<ul style="list-style-type: none"> • Check whether the top of the refrigerator is tilted back 10-15mm to allow the doors to self close. • Check whether something is holding the door open. <p>It is normal for the freezer door to momentarily open and re-close, when the food storage compartment door is closed. If the freezer door stays open, it indicates that the refrigerator needs to be tilted backwards a little further. If you call a service person to solve this problem you will be charged for the cost of the service call, this is not a warranty fault.</p>

If you still require service

If you have a problem, and the problem persists after you have made the checks mentioned above, contact your nearest Electrolux approved Service Centre or the dealer you bought the refrigerator from. Be ready to quote the model number, 9-digit PNC and 8-digit serial number, which is stated on the label inside the refrigerator compartment.

This document sets out the terms and conditions of the product warranties for Electrolux Appliances. It is an important document. Please keep it with your proof of purchase documents in a safe place for future reference should you require service for your Appliance.

1. In this warranty
 - (a) 'acceptable quality' as referred to in clause 10 of this warranty has the same meaning referred to in the ACL;
 - (b) 'ACL' means Trade Practices Amendment (Australian Consumer Law) Act (No.2) 2010;
 - (c) 'Appliance' means any Electrolux product purchased by you accompanied by this document;
 - (d) 'ASC' means Electrolux' authorised serviced centres;
 - (e) 'Electrolux' means Electrolux Home Products Pty Ltd of 163 O'Riordan Street, Mascot, NSW 2020, ABN 51 004 762 341 in respect of Appliances purchased in Australia and Electrolux (NZ) Limited of 3-5 Niall Burgess Road, Mount Wellington, in respect of Appliances purchased in New Zealand;
 - (f) 'major failure' as referred to in clause 10 of this warranty has the same meaning referred to in the ACL and includes a situation when an Appliance cannot be repaired or it is uneconomic for Electrolux, at its discretion, to repair an Appliance during the Warranty Period;
 - (g) 'Warranty Period' means:
 - (i) where the Appliance is used for personal, domestic or household use (i.e. normal single family use) as set out in the instruction manual, the Appliance is warranted against manufacturing defects in Australia and New Zealand for 24 months and for the Appliance's compressor, condenser, evaporator and drier, an additional 36 months parts only warranty applies, following the date of original purchase of the Appliance;
 - (ii) where the Appliance is used for commercial purposes (including being used to directly assist a business or where the Appliance is used in a multi-family communal or share type environment), the Appliance will then be warranted against manufacturing defects in Australia for 3 months and in New Zealand for 3 months, following the date of original purchase of the Appliance.
 - (h) 'you' means the purchaser of the Appliance not having purchased the Appliance for re-sale, and 'your' has a corresponding meaning.
2. This warranty only applies to Appliances purchased and used in Australia or New Zealand and is in addition to (and does not exclude, restrict, or modify in any way) any non-excludable statutory warranties in Australia or New Zealand.
3. During the Warranty Period Electrolux or its ASC will, at no extra charge if your Appliance is readily accessible for service, without special equipment and subject to these terms and conditions, repair or replace any parts which it considers to be defective. Electrolux or its ASC may use remanufactured parts to repair your Appliance. You agree that any replaced Appliances or parts become the property of Electrolux. This warranty does not apply to light globes, batteries, filters or similar perishable parts.
4. Parts and Appliances not supplied by Electrolux are not covered by this warranty.
5. You will bear the cost of transportation, travel and delivery of the Appliance to and from Electrolux or its ASC. If you reside outside of the service area, you will bear the cost of:
 - (a) travel of an authorised representative;
 - (b) transportation and delivery of the Appliance to and from Electrolux or its ASC,

In all instances, unless the Appliance is transported by Electrolux or an
- Electrolux authorised representative, the Appliance is transported at the owner's cost and risk while in transit to and from Electrolux or its ASC.
6. Proof of purchase is required before you can make a claim under this warranty.
7. You may not make a claim under this warranty unless the defect claimed is due to faulty or defective parts or workmanship. Electrolux is not liable in the following situations (which are not exhaustive):
 - (a) the Appliance is damaged by:
 - (i) accident
 - (ii) misuse or abuse, including failure to properly maintain or service
 - (iii) normal wear and tear
 - (iv) power surges, electrical storm damage or incorrect power supply
 - (v) incomplete or improper installation
 - (vi) incorrect, improper or inappropriate operation
 - (vii) insect or vermin infestation
 - (viii) failure to comply with any additional instructions supplied with the Appliance;
 - (b) the Appliance is modified without authority from Electrolux in writing;
 - (c) the Appliance's serial number or warranty seal has been removed or defaced;
 - (d) the Appliance was serviced or repaired by anyone other than Electrolux, an authorised repairer or ASC.
8. This warranty, the contract to which it relates and the relationship between you and Electrolux are governed by the law applicable where the Appliance was purchased. Where the Appliance was purchased in New Zealand for business purposes the Consumer Guarantee Act does not apply.
9. To the extent permitted by law, Electrolux excludes all warranties and liabilities (other than as contained in this document) including liability for any loss or damage whether direct or indirect arising from your purchase, use or non use of the Appliance.
10. For Appliances and services provided by Electrolux in Australia, the Appliances come with a guarantee by Electrolux that cannot be excluded under the Australian Consumer Law. You are entitled to a replacement or refund for a major failure and for compensation for any other reasonably foreseeable loss or damage. You are also entitled to have the Appliance repaired or replaced if the Appliance fails to be of acceptable quality and the failure does not amount to a major failure. The benefits to you given by this warranty are in addition to your other rights and remedies under a law in relation to the Appliances or services to which the warranty relates.
11. At all times during the Warranty Period, Electrolux shall, at its discretion, determine whether repair, replacement or refund will apply if an Appliance has a valid warranty claim applicable to it.
12. For Appliances and services provided by Electrolux in New Zealand, the Appliances come with a guarantee by Electrolux pursuant to the provisions of the Consumer Guarantees Act, the Sale of Goods Act and the Fair Trading Act.
13. To enquire about claiming under this warranty, please follow these steps:
 - (a) carefully check the operating instructions, user manual and the terms of this warranty;
 - (b) have the model and serial number of the Appliance available;
 - (c) have the proof of purchase (eg an invoice) available;
 - (d) telephone the numbers shown below.
14. You accept that if you make a warranty claim, Electrolux and its ASC may exchange information in relation to you to enable Electrolux to meet its obligations under this warranty.

Important Notice

Before calling for service, please ensure that the steps listed in point 13 above have been followed.

<p>FOR SERVICE or to find the address of your nearest state service centre in Australia PLEASE CALL 13 13 49 For the cost of a local call (Australia only)</p>	<p>SERVICE AUSTRALIA  ELECTROLUX HOME PRODUCTS www.electrolux.com.au</p>	<p>FOR SPARE PARTS or to find the address of your nearest state spare parts centre in Australia PLEASE CALL 13 13 50 For the cost of a local call (Australia only)</p>
<p>FOR SERVICE or to find the address of your nearest authorised service centre in New Zealand FREE CALL 0800 10 66 10 (New Zealand only)</p>	<p>SERVICE NEW ZEALAND  ELECTROLUX HOME PRODUCTS www.electrolux.co.nz</p>	<p>FOR SPARE PARTS or to find the address of your nearest state spare parts centre in New Zealand FREE CALL 0800 10 66 20 (New Zealand only)</p>

Electrolux Home Products Australia

telephone: 1300 363 640
fax: 1800 350 067
email: customercare@electrolux.com.au
web: www.electrolux.com.au

Electrolux Home Products New Zealand

telephone: 09 573 2384
fax: 09 573 2221
email: customercare@electrolux.co.nz
web: www.electrolux.co.nz

The Thoughtful Design Innovator.

Do you remember the last time you opened a gift that made you say “Oh! How did you know? That’s exactly what I wanted!” That’s the kind of feeling that the designers at Electrolux seek to evoke in everyone who chooses or uses one of our products. We devote time, knowledge, and a great deal of thought to anticipating and creating the kind of appliances that our customers really need and want.

This kind of thoughtful care means innovating with insight. Not design for design’s sake, but design for the user’s sake. For us, thoughtful design means making appliances easier to use and tasks more enjoyable to perform, freeing our customers to experience that ultimate 21st century luxury, ease of mind. Our aim is to make this ease of mind more available to more people in more parts of their everyday lives, all over the world. So when we say we’re thinking of you, you know we mean just that.

The “Thinking of you” promise from Electrolux goes beyond meeting the needs of today’s consumers. It also means we’re committed to making appliances safe for the environment—now and for future generations.

Electrolux. Thinking of you.

Share more of our thinking at www.electrolux.com.au or www.electrolux.co.nz

P/No. 1461407

© 2013 Electrolux Home Products Pty Ltd
ABN 51 004 762 341

EFFRIDGEUM_Mar13