

WORX

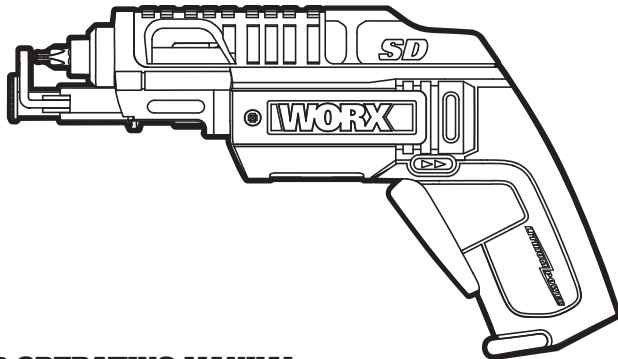

SAFETY AND OPERATING MANUAL

SD SLIDE
DRIVER™

WX255 WX255.X



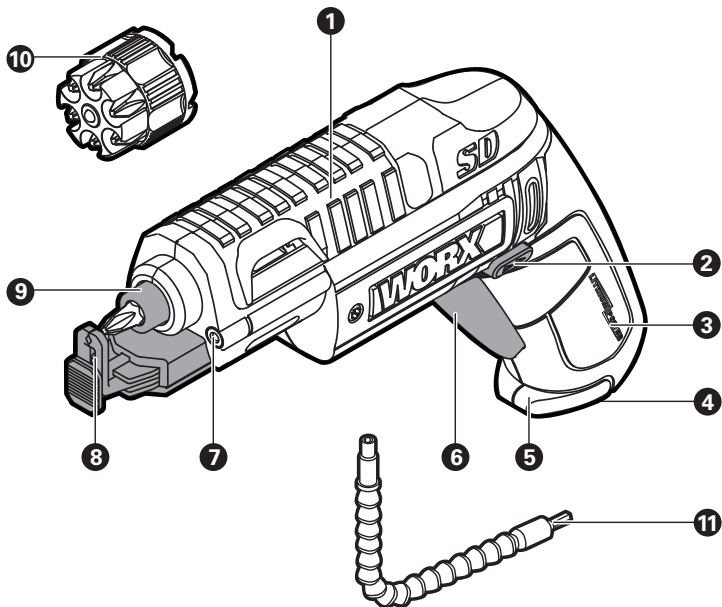

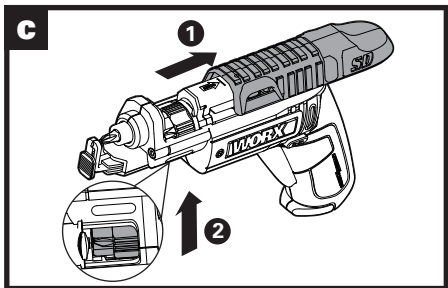
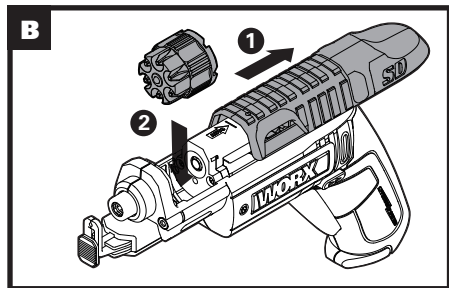
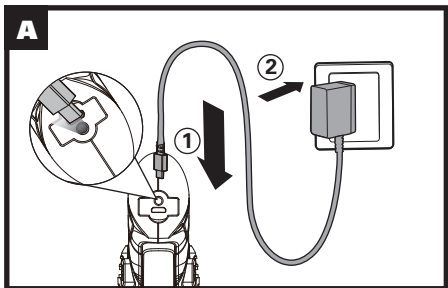

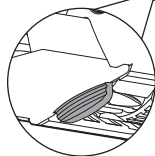
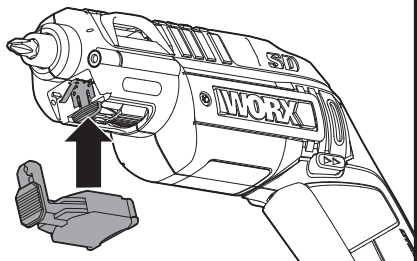
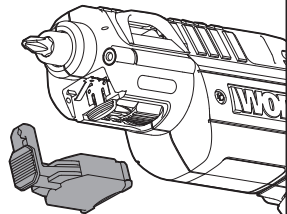
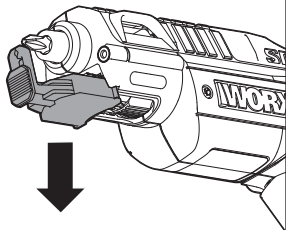
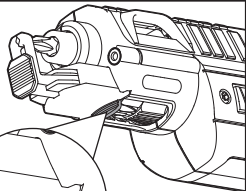
D1**D2**

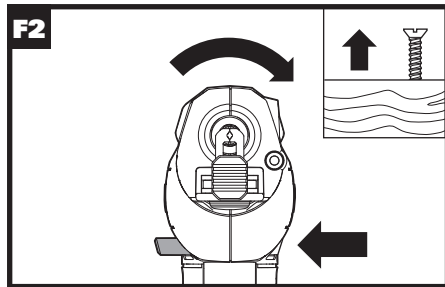
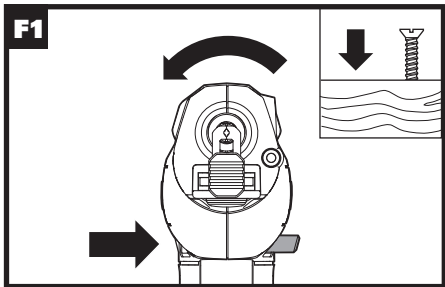
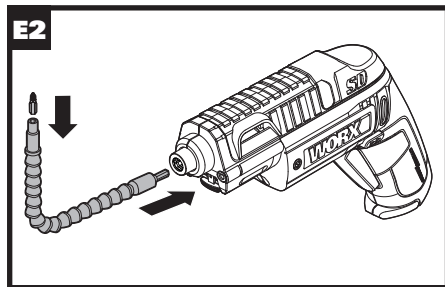
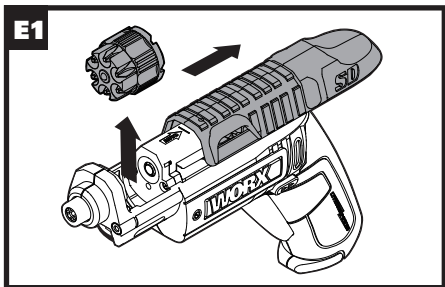

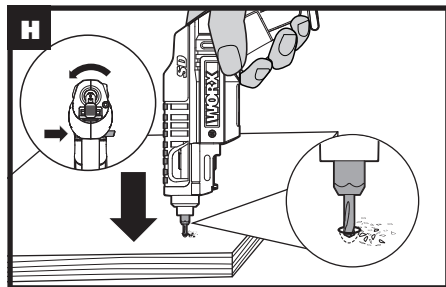
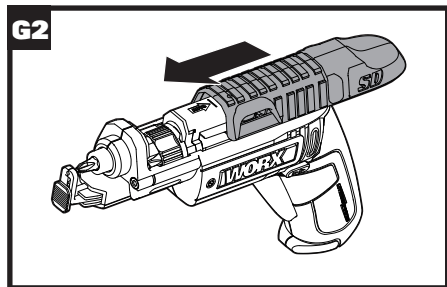
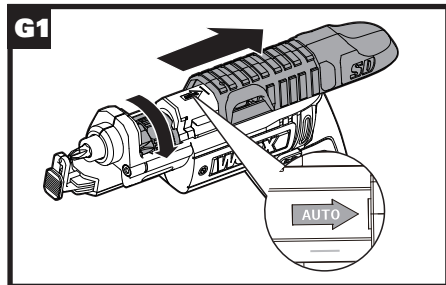
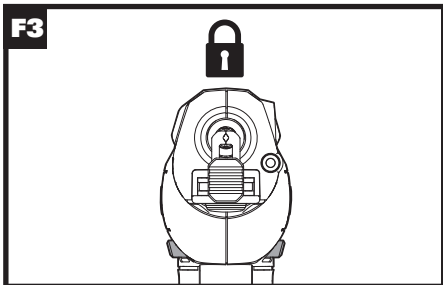

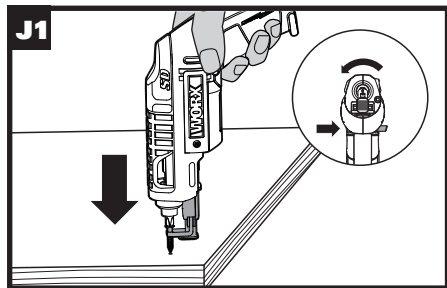
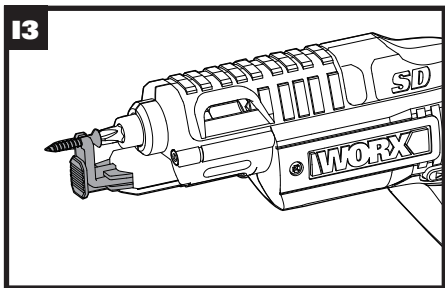
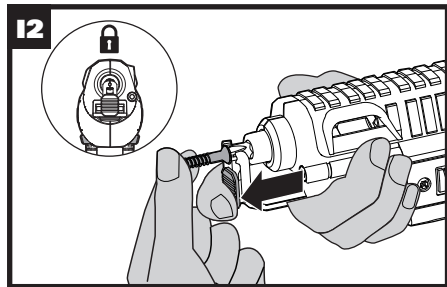
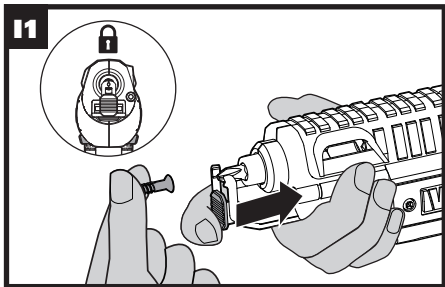

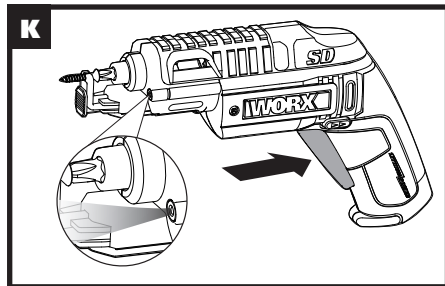
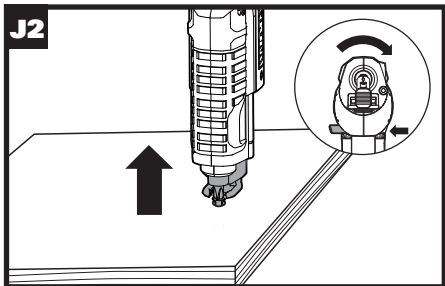

ORIGINAL INSTRUCTIONS

PRODUCT SAFETY

GENERAL POWER TOOL SAFETY WARNINGS

 **WARNING: Read all safety warnings, instructions, illustrations and specifications provided with this power tool.** *Failure to follow all instructions listed below may result in electric shock, fire and/or serious injury.*

Save all warnings and instructions for future reference.

The term “power tool” in the warnings refers to your mains-

operated (corded) power tool or battery-operated (cordless) power tool.

1. WORK AREA SAFETY

- a) Keep work area clean and well lit.** *Cluttered or dark areas invite accidents.*
- b) Do not operate power tools in explosive atmospheres, such as in the presence of flammable liquids, gases or dust.** *Power tools create sparks which may ignite the dust or fumes.*
- c) Keep children and bystanders away while operating a power tool.**

Distractions can cause you to lose control.

2) ELECTRICAL SAFETY

a) Power tool plugs must match the outlet. Never modify the plug in any way. Do not use any adapter plugs with earthed (grounded) power tools.

Unmodified plugs and matching outlets will reduce risk of electric shock.

b) Avoid body contact with earthed or grounded surfaces, such as pipes, radiators, ranges and refrigerators. *There is an*

increased risk of electric shock if your body is earthed or grounded.

c) Do not expose power tools to rain or wet conditions.

Water entering a power tool will increase the risk of electric shock.

d) Do not abuse the cord. Never use the cord for carrying, pulling or unplugging the power tool. Keep cord away from heat, oil, sharp edges or moving parts. *Damaged or entangled cords increase the risk of electric shock.*

e) When operating a power

tool outdoors, use an extension cord suitable for outdoor use. *Use of a cord suitable for outdoor use reduces the risk of electric shock.*

f) If operating a power tool in a damp location is unavoidable, use a residual current device (RCD) protected supply. *Use of an RCD reduces the risk of electric shock.*

3) PERSONAL SAFETY

a) Stay alert, watch what you are doing and use common sense when

operating a power tool. Do not use a power tool while you are tired or under the influence of drugs, alcohol or medication. *A moment of inattention while operating power tools may result in serious personal injury.*

b) Use personal protective equipment. Always wear eye protection. *Protective equipment such as dust mask, non-skid safety shoes, hard hat, or hearing protection used for appropriate conditions will reduce personal injuries.*

c) Prevent unintentional

starting. Ensure the switch is in the off-position before connecting to power source and/or battery pack, picking up or carrying the tool. *Carrying power tools with your finger on the switch or energising power tools that have the switch on invites accidents.*

d) Remove any adjusting key or wrench before turning the power tool on. *A wrench or a key left attached to a rotating part of the power tool may result in personal injury.*

e) Do not overreach. Keep proper footing and balance

at all times. *This enables better control of the power tool in unexpected situations.*

f) Dress properly. Do not wear loose clothing or jewellery. Keep your hair and clothing away from moving parts. *Loose clothes, jewellery or long hair can be caught in moving parts.*

g) If devices are provided for the connection of dust extraction and collection facilities, ensure these are connected and properly used. *Use of dust collection can reduce dust-related hazards.*

h) Do not let familiarity gained from frequent use of tools allow you to become complacent and ignore tool safety principles. *A careless action can cause severe injury within a fraction of a second.*

4) POWER TOOL USE AND CARE

a) Do not force the power tool. Use the correct power tool for your application. *The correct power tool will do the job better and safer at the rate for which it was designed.*

b) Do not use the power tool

if the switch does not turn it on and off. *Any power tool that cannot be controlled with the switch is dangerous and must be repaired.*

c) Disconnect the plug from the power source and/or remove the battery pack, if detachable, from the power tool before making any adjustments, changing accessories, or storing power tools. *Such preventive safety measures reduce the risk of starting the power tool accidentally.*

d) Store idle power tools out of the reach of children

and do not allow persons unfamiliar with the power tool or these instructions to operate the power tool.

Power tools are dangerous in the hands of untrained users.

e) Maintain power tools and accessories. Check for misalignment or binding of moving parts, breakage of parts and any other condition that may affect the power tool's operation.

If damaged, have the power tool repaired before use. Many accidents are caused by poorly maintained power tools.

f) Keep cutting tools sharp and clean. *Properly maintained cutting tools with sharp cutting edges are less likely to bind and are easier to control.*

g) Use the power tool, accessories and tool bits etc. in accordance with these instructions, taking into account the working conditions and the work to be performed. *Use of the power tool for operations different from those intended could result in a hazardous situation.*

h) Keep handles and grasping

surfaces dry, clean and free from oil and grease.

Slippery handles and grasping surfaces do not allow for safe handling and control of the tool in unexpected situations.

5) BATTERY TOOL USE AND CARE

a)Recharge only with the charger specified by the manufacturer. *A charger that is suitable for one type of battery pack may create a risk of fire when used with another battery pack.*

b)Use power tools only with specifically designated

battery packs. *Use of any other battery packs may create a risk of injury and fire.*

c)When battery pack is not in use, keep it away from other metal objects, like paper clips, coins, keys, nails, screws or other small metal objects, that can make a connection from one terminal to another.

Shorting the battery terminals together may cause burns or a fire.

d)Under abusive conditions, liquid may be ejected from the battery; avoid contact. If contact accidentally

occurs, flush with water.

If liquid contacts eyes, additionally seek medical help. Liquid ejected from the battery may cause irritation or burns.

e) Do not use a battery pack or tool that is damaged or modified.

Damaged or modified batteries may exhibit unpredictable behaviour resulting in fire, explosion or risk of injury.

f) Do not expose a battery pack or tool to fire or excessive temperature.

Exposure to fire or temperature above 130 °C may

cause explosion.

g) Follow all charging instructions and do not charge the battery pack or tool outside the temperature range specified in the instructions.

Charging improperly or at temperatures outside the specified range may damage the battery and increase the risk of fire.

6) SERVICE

a) Have your power tool serviced by a qualified repair person using only identical replacement

parts. *This will ensure that the safety of the power tool is maintained.*

b) Never service damaged battery packs. *Service of battery packs should only be performed by the manufacturer or authorized service providers.*

SCREW DRIVER SAFETY WARNING

1. Hold power tool by insulated gripping surfaces, when performing an operation where the fastener may contact hidden wiring. Fasteners

contacting a “live” wire may make exposed metal parts of the power tool “live” and could give the operator an electric shock.

DRILL SAFETY WARNINGS

1) Safety instructions for all operations

a) Hold the power tool by insulated gripping surfaces, when performing an operation where the cutting accessory or fasteners may contact hidden wiring. Cutting accessory or fasteners

contacting a “live” wire may make exposed metal parts of the power tool “live” and could give the operator an electric shock.

2) Safety instructions when using long drill bits

a) Never operate at higher speed than the maximum speed rating of the drill bit.

At higher speeds, the bit is likely to bend if allowed to rotate freely without contacting the workpiece, resulting in personal injury.

b) Always start drilling at low speed and with the bit tip in contact with

the workpiece. At higher speeds, the bit is likely to bend if allowed to rotate freely without contacting the workpiece, resulting in personal injury.

c) Apply pressure only in direct line with the bit and do not apply excessive pressure.

Bits can bend causing breakage or loss of control, resulting in personal injury.

SAFETY WARNINGS FOR BATTERY CELLS INSIDE THE TOOL

a) Do not dismantle, open or shred cells.

- b) Do not short-circuit charging terminal. Do not store power tool haphazardly in a box or drawer where charging terminal may short-circuit each other or be short-circuited by conductive materials.** When power tool is not in use, keep it away from other metal objects, like paper clips, coins, keys, nails, screws or other small metal objects, that can make a connection from one charging terminal to another.
- c) Do not expose power tool to heat or fire. Avoid**

- storage in direct sunlight.**
- d) Do not subject power tool to mechanical shock.**
- e) In the event of battery leaking, do not allow the liquid to come into contact with the skin or eyes. If contact has been made, wash the affected area with copious amounts of water and seek medical advice.**
- f) Keep power tool clean and dry.**
- g) Wipe the charging terminals with a clean dry cloth if they become dirty.**
- h) Power tool needs to be**

charged before use. Always refer to this instruction and use the correct charging procedure.

- i) Do not maintain power tool on charge when not in use.**
- j) After extended periods of storage, it may be necessary to charge and discharge the power tool several times to obtain maximum performance.**
- k) Recharge only with the charger specified by Worx. Do not use any charger other than that specifically provided for use with the**

equipment. A charger that is suitable for one type of battery may create a risk of fire when used with another battery.

- l) Keep power tool out of the reach of children.**
- m) Retain the original product literature for future reference.**
- n) Dispose of properly.**
- o) Do not mix cells of different manufacture, capacity, size or type within a device.**
- p) Do not use any cell which is not designed for use with the equipment.**

q) Keep the battery away from microwaves and high pressure.

GENERAL SAFETY WARNINGS FOR YOUR BATTERY CHARGER

WARNING  **Read all safety warnings and all instructions.** Failure to follow the warnings and instructions may result in electric shock, fire and/or serious injury.

Save all warnings and instructions for future reference.

This appliance can be used by children aged from 8 years and

above and persons with reduced physical, sensory or mental capabilities or lack of experience and knowledge if they have been given supervision or instruction concerning use of the appliance in a safe way and understand the hazards involved. Children shall not play with the appliance. Cleaning and user maintenance shall not be made by children without supervision. If the supply cord is damaged, it must be replaced by the manufacturer, its service agent or similarly qualified persons in order to avoid a hazard.

ADDITIONAL SAFETY INSTRUCTIONS FOR YOUR BATTERY CHARGER

1. Before charging, read the instructions.
2. Do not charge a leaking battery.
3. Do not use chargers for works other than those for which they are designed.
4. Before charging, ensure your charger is matching the local AC supply.
5. For indoor use, or do not expose to rain.
6. The charging device must be protected from moisture.
7. Do not use the charging device in the open.
8. Do not short out the contacts of battery or charger.
9. Respect the polarity "+/-" when charging.
10. Do not open the unit and keep out of the reach of children.
11. Do not charge the batteries of other manufactures or ill-suited models.
12. Ensure that the connection between the battery charger and battery is correctly positioned and is not obstructed by foreign bodies.
13. Keep battery charger's slots are free of foreign objects and protect against dirt and







humidity. Store in a dry and frost-free place.









14. When charging batteries, ensure that the battery charger is in a well-ventilated area and away from inflammable materials. Batteries can get hot during charging. Do not overcharge any batteries. Ensure that batteries and chargers are not left unsupervised during charging.
15. Do not recharge non-rechargeable batteries, as they can overheat and break.
16. Longer life and better performance can be obtained

if the battery pack is charged when the air temperature is between 18°C and 24°C. Do not charge the battery pack in air temperatures below 0°C, or above 40°C. This is important as it can prevent serious damage to the battery pack.

17. Charge only battery pack of the same model provided by Worx and of models recommended by Worx.

SYMBOLS

	Do not stare directly into the tool holder. When changing the tool insert, it can be thrown out toward the front
	To reduce the risk of injury, user must read instruction manual
	Warning
	Wear eye protection
	Wear ear protection
	Wear dust mask
	Wear protective gloves
	Double insulation (for charger)
	Do not burn

	Do not expose to rain or water
	For indoor use only (for charger)
	Read the operator's manual
	Lock
	The output plug is with positive center pole and negative outer pole
	Fuse
	Waste electrical products must not be disposed of with household waste. Please recycle where facilities exist. Check with your local authorities or retailer for recycling advice.
 	Do not dispose of batteries, Return exhausted batteries to your local collection or recycling point



RCM marking

ABN: Australian Business Number. By this number, business information such as entity type, status, business location etc. can be found at website <http://abr.business.gov.au>.
ABN of Positec Australia Pty Limited is 14 101 682 357

COMPONENT LIST

- 1. SLIDE COVER**
- 2. FORWARD/REVERSE ROTATION CONTROL**
- 3. SOFT GRIP HANDLE**
- 4. CHARGING INDICATOR**
- 5. CHARGING SOCKET**
- 6. ON/OFF SWITCH**
- 7. LED LIGHT**
- 8. SCREW HOLDER**
- 9. CHUCK**
- 10. BIT CARTRIDGE**

11. EXTENDABLE FLEXIBLE SHAFT *

*** Not all the accessories illustrated or described are included in standard delivery.**

TECHNICAL DATA

Type **WX255 WX255.X (250~269-designation of machinery, representative of Battery-powered Screwdriver)**

	WX255 WX255.X**
Charger voltage	100-240V~ 50/60Hz
Rated voltage	4V $\frac{---}{---}$ Max***
Charger input power	3W
Battery capacity	1.5Ah Li-Ion
No-load speed	230/min
Maximum torque	3N.m
Machine weight	0.5kg
Charger Protection class	□/II
Charging time (Approx.)	5 hours (Approx.)

** X=1-999, A-Z, M1-M9 there are only used for different customers, there are no safe relevant changes between these models.

*** Voltage measured without workload. Initial battery voltage reaches maximum of 4 volts. Nominal voltage is 3.6 volts.

For the technical data of the types, the number of cells and the rated capacity of the batteries that can be charged, please

refer the nameplate of the tool supplied by Worx. We recommend that you purchase your accessories from the same store that sold you the tool. Refer to the accessory packaging for further details. Store personnel can assist you and offer advice.

NOISE INFORMATION

A weighted sound pressure L_{pA} : 65dB(A)

A weighted sound power L_{wA} : 76dB(A)

K_{pA} & K_{wA} 3.0dB(A)

Wear ear protection.

VIBRATION INFORMATION

Vibration total values (triax vector sum) determined according to EN 62841:

Vibration emission value: $a_h = 0.70\text{m/s}^2$

Uncertainty $K = 1.5\text{m/s}^2$

The declared vibration total value and the declared noise emission value have been measured in accordance with a standard test method and may be used for comparing one tool with another.

The declared vibration total value and the declared noise emission value may also be used in a preliminary assessment of exposure.



WARNING: The vibration and noise emissions during actual use of the power tool can differ from the declared value depending on the ways in which the tool is used especially what kind of workpiece is processed dependant on the following examples and other variations on how the tool is used:

How the tool is used and the materials being cut or drilled.

The tool being in good condition and well maintained.

The use of the correct accessory for the tool and ensuring it is sharp and in good condition.

The tightness of the grip on the handles and if any anti vibration and noise accessories are used.

And the tool is being used as intended by its design and these instructions.

This tool may cause hand-arm vibration syndrome if its use is not adequately managed.



WARNING: To be accurate, an estimation of exposure level in the actual conditions of use should also take account of all parts of the operating cycle such as the times when the tool is switched off and when it is running idle but not actually doing the job. This may significantly reduce the exposure level over the total working period.

Helping to minimise your vibration and noise exposure risk.

Always use sharp chisels, drills and blades.

Maintain this tool in accordance with these instructions and keep well lubricated (where appropriate).

If the tool is to be used regularly then invest in anti vibration and noise accessories.

Plan your work schedule to spread any high vibration tool use across a number of days.

OPERATING INSTRUCTIONS



NOTE: Before using the tool, read the instruction book carefully.

INTENDED USE

The power tool is intended for driving in and loosening screws as well as for drilling in wood, metal and plastic.

ACTION	FIGURE
BEFORE OPERATION	
Charging the Battery NOTE: 1. Maximize Battery Performance Prior to initial use, the battery must be charged 5 hours to fully utilize the battery capacity. 2. When the battery is full charged, the light turns green.	See Fig. A
ASSEMBLY AND ADJUSTMENT	
Inserting and Removing the Bit Cartridge	See Fig. B,C
Assembling and Removing the Screw Holder	See Fig. D1,D2
Installing and removing extendable flexible shaft (optional)	See Fig. E1,E2

Forward/reverse/lock



WARNING: Never change the direction of rotation when the chuck is rotating, wait until it is stopped!

See Fig F1,F2,F3

OPERATION

Selecting a Bit

See Fig G1,G2

Drilling a Pilot Hole

See Fig H

Assembling screw

See Fig I1,I2,I3

Tightening and Loosening Screw

See Fig J1, J2

Operating the On/Off Switch



WARNING: Do not operate for long periods at low speed because excess heat will be produced internally.

See Fig K

LED Light Indicator

See Fig K

Automatic Spindle Locking

NOTE: When the slide driver is out of power, this function enables the customer tightening or loosening screws manually.

MAINTENANCE

Your power tool requires no additional lubrication or maintenance. There is no user serviceable parts in your power tool. Never use water or chemical cleaners to clean your power tool. Wipe clean with a dry cloth. Always store your power tool in a dry place. Keep the motor ventilation slots clean. Keep all

working controls free of dust. If you see some sparks flashing in the ventilation slots, this is normal and will not damage your power tool.

ENVIRONMENTAL PROTECTION



Waste electrical products must not be disposed of with household waste. Please recycle where facilities exist.

Check with your local authorities or retailer for recycling advice.

FOR BATTERY TOOLS

The ambient temperature range for the use and storage of tool and battery is 0°C-45°C.

The recommended ambient temperature range for the charging system during charging is 0°C-40°C.

PLUG REPLACEMENT (ONLY FOR REWIRABLE PLUG OF UK & IRELAND)

If you need to replace the fitted plug then follow the instructions below.

IMPORTANT

The wires in the mains lead are colored in accordance with the following code:

Blue = Neutral

Brown = Live

As the colors of the wires in the mains lead of this appliance may not correspond with the colored markings identifying the terminals in your plug, proceed as follows. The wire which is colored blue must be connected to the terminal which is marked with N. The wire which is colored brown must be connected to the terminal which is marked with L.



WARNING: Never connect live or neutral wires to the earth terminal of the plug. Only fit an approved BS1363/A plug and the correct rated current fuse which is used in the plug.

NOTE: If a moulded plug is fitted and has to be removed take great care in disposing of the plug and severed cable, it must be destroyed to prevent engaging into a socket.

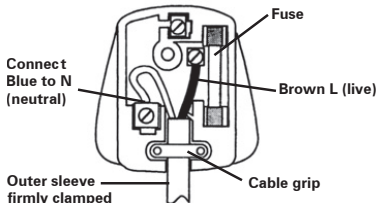

TROUBLE SHOOTING

Problem	Possible cause	Solution
Battery will not charge	1. Charger not plugged into a working outlet. 2. Surrounding air temperature is too hot or too cold.	1. Plug charger into a working outlet. Check current by plugging in a lamp. 2. Move charger to an appropriate place which temperature is suitable for the charger.
Switch cannot be pressed	Forward/Reverse switch at middle position	Make sure switch is on Forward or Reverse rotation according to project need.
Driver stops during driving screws	Driver battery is out of power	Make sure the driver is fully charged before using it.
Bit Cartridge will not rotate when Cover slides.	The cover is not fully open	Make sure the Cover is fully open and past the red line on the tool.

DECLARATION OF CONFORMITY

Park, Jiangsu 215123, P. R. China

We,
Positec Germany GmbH
Postfach 32 02 16, 50796 Cologne, Germany

On behalf of Positec declare that the product,
Description **Battery-powered Screwdriver**
Type **WX255 WX255.X (250~269 - designation of machinery, representative of Battery-powered Screwdriver)**
Function **Tightening and loosening screws, nuts**

Complies with the following directives,
2006/42/EC 2011/65/EU&(EU)2015/863
2014/30/EU 2014/35/EU

Standards conform to:

30 **EN 62841-1, EN 62841-2-2, EN 55014-1,**
EN 55014-2, EN 60335-1, EN 60335-2-29,
EN 62233, EN IEC 61000-3-2, EN 61000-3-3

The person authorized to compile the technical file,
Name: Marcel Filz
Address: Positec Germany GmbH
Postfach 32 02 16, 50796 Cologne, Germany



2021/10/22
Allen Ding
Deputy Chief Engineer, Testing & Certification
Positec Technology (China) Co., Ltd
18, Dongwang Road, Suzhou Industrial

DECLARATION OF CONFORMITY

We,
Positec (UK & Ireland) Ltd.,
PO Box 6242, Newbury, RG14 9LT, UK

On behalf of Positec declare that the product,
Description **Battery-powered Screwdriver**
Type **WX255 WX255.X (250~269 - designation of machinery, representative of Battery-powered Screwdriver)**
Function **Tightening and loosening screws, nuts**

Complies with the following regulations,
Supply of Machinery (Safety) Regulations 2008
Electromagnetic Compatibility Regulations 2016
The Restriction of the Use of Certain Hazardous Substances in Electrical and Electronic Equipment Regulations
Electrical Equipment (Safety) Regulations 2016

Standards conform to:

BS EN 62841-1, BS EN 62841-2-2,
BS EN 55014-1, BS EN 55014-2
BS EN 60335-1, BS EN 60335-2-29,
BS EN 62233, BS EN IEC 61000-3-2,
BS EN 61000-3-3

The person authorized to compile the technical file,

Name Jim Kirkwood
Address Positec (UK & Ireland) Ltd.,
PO Box 6242, Newbury, RG14 9LT, UK

2021/10/22
Allen Ding
Deputy Chief Engineer, Testing & Certification
Positec Technology (China) Co., Ltd
18, Dongwang Road, Suzhou Industrial
Park, Jiangsu 215123, P. R. China



After-sales Service and Application

At www.worx.com you can order spare parts or arrange the collection of a product in need of servicing or repair.

Tel. Service: 0345 202 9679

E-Mail: customerservices@worxtools.com

www.worx.com

Copyright © 2022, Positec. All Rights Reserved.
AR01233505