



Dryer

Contents

Appliance Registration	2	Problem Solver	10-12
Automatic Drying	5	Safety Instructions	3,4
Care and Cleaning	13	Sorting	4,8
Consumer Services	15	Storing Dryer	13
Controls Setting Guide	6,7	Timed Drying	5
Dryer Exhaust	13	User Maintenance Instructions	13
End-of-Cycle Signal	5	Warranty	Back Cover
Energy-Saving Tips	9		
Extra Care Cycle	4		
Knits Drying Tips	5-7, 11		
Light Bulb Replacement	13		
Lint Filter	4,9, 13		
Loading	4,9		
Model and Serial Numbers	2		
operating the Dryer	4,5	GE Answer Center[™]	
Perm. Press Drying Tips	5-7, 11, 12	800.626.2000	

**Models DDE8200G
DDG8280G**

GE Appliances

Help us help you...

Before using your dryer, read this book carefully.

It is intended to help you operate and maintain your new dryer properly.

Keep it handy for answers to your questions.

If you don't understand something or need more help, write (include your phone number):

Consumer Affairs
GE Appliances
Appliance Park
Louisville, KY40225

If you received a damaged dryer...

Immediately contact the dealer (or builder) that sold you the dryer.

Save time and money.

Before you request service . . . check the Problem Solver on pages 10-12. It lists causes of minor operating problems that you can correct yourself.

Write down the model and serial numbers.

You'll find them on a label on the front of the dryer behind the door.

These numbers are also on the Consumer Product Ownership Registration Card that came with your dryer. Before sending in this card, please write these numbers here:

Model Number

Serial Number

Use these numbers in any correspondence or service calls concerning your dryer.

All drying instruction terms in this book conform to the Care Labeling Rule established by the Federal Trade Commission, January 1984.

If You Need Service

To obtain service, see the Consumer Services page in the back of this book.

We're proud of our service and want you to be pleased. If for some reason you are not happy with the service you receive, here are three steps to follow for further help.

FIRST, contact the people who serviced your appliance. Explain why you are not pleased. In most cases, this will solve the problem.

NEXT, if you are still not pleased, write all the details—including your phone number—to:

Manager, Consumer Relations
GE Appliances
Appliance Park
Louisville, Kentucky 40225

FINALLY, if your problem is still not resolved, write:

Major Appliance
Consumer Action Panel
20 North Wacker Drive
Chicago, Illinois 60606

To obtain a Spanish language version of this book, call GE Answer Center™ 800.626.2000 consumer information service.

Para obtener la version en español de este manual, name a GE Answer Center® servicio de information para el consumidor, teléfono 800.626.2000.

FOR YOUR SAFETY

If you smell gas:

1. Open windows.
2. Don't touch electrical switches.*
3. Extinguish any open flame.
4. Immediately call your gas supplier.

*Don't turn electric switches on or off because sparks may ignite the gas.

FOR YOUR SAFETY

Do not store or use gasoline or other flammable vapors and liquids in the vicinity of this or any other appliance.

IMPORTANT SAFETY INSTRUCTIONS

Read all instructions before using this appliance.

IMPORTANT SAFETY NOTICE

The California Safe Drinking Water and Toxic Enforcement Act requires the Governor of California to publish a list of substances known to the state to cause cancer, birth defects or other reproductive harm and requires businesses to warn customers of potential exposure to such substances.

Gas appliances can cause minor exposure to four of these substances, namely benzene, carbon monoxide, formaldehyde and soot, caused primarily by the incomplete combustion of natural gas or LP fuels. Properly adjusted dryers will minimize incomplete combustion. Exposure to these substances can be minimized further by properly venting the dryers to the outdoors.

WARNING—To reduce the risk of fire, electric shock, or injury to persons when using your appliance, follow basic precautions, including the following:

• **Use this appliance only for its intended purpose** as described in this Use and Care Book.

• **This dryer must be properly installed and located in accordance with the Installation Instructions before it is used.** If you did not receive an Installation Instructions sheet with your dryer, you can obtain one by contacting the service location nearest you.

—**Properly ground to conform with all governing codes and ordinances. Follow details in Installation Instructions.**

—**Locate where the temperature is above 50°F. (10°C.) for satisfactory operation of the dryer control system. Do not install or store the dryer where it will be exposed to the weather.**

—**Connect to a properly rated, protected and sized power-supply circuit to avoid electrical overload.**

—**Exhausting to the outside is STRONGLY RECOMMENDED**

to prevent large amounts of moisture and lint from being blown into the room. Carefully follow the Exhausting Details in the **Installation Instructions**.

• **When disconnecting this appliance pull by the plug rather than the cord to avoid damage to the cord or junction of cord and plug. Make sure that the cord is located so that it will not be stepped on, tripped over or otherwise subjected to damage or stress.**

• **Do not repair or replace any part of the appliance or attempt any servicing unless specifically recommended in this Use and Care Book or in published user-repair instructions that you understand and have the skills to carry out.**

To minimize the possibility of a fire hazard.

• **Do not use heat to dry articles containing rubber, plastic, or similar materials (such as padded bras, tennis shoes, galoshes, bath mats, rugs, bibs, baby pants, plastic bags, etc.) as these materials may melt or burn. Also, some rubber materials, when heated, can under certain circumstances produce fire by spontaneous combustion.**

• **Garments labeled “Dry Away From Heat” (such as life jackets containing Kapok) must not be put in your dryer.**

• **Do not wash or dry articles that have been cleaned in, washed in, soaked in, or spotted with combustible or explosive substance (such as wax, paint, gasoline, degreasers, dry-cleaning solvents, kerosene, etc.) which may ignite or explode. Do not use or store such substances on/or around your washer and/or dryer during operation.**

• **Any article on which you have used a cleaning solvent, or which contains flammable materials**

(such as cleaning cloths, mops, towels used in beauty salons, restaurants or barber shops, etc.) must not be placed in or near the dryer until all traces of these flammable liquids or solids and their fumes have been removed. There are many highly flammable items used in homes such as: acetone, denatured alcohol, gasoline, kerosene, some household cleaners, some spot removers, turpentine, waxes, wax removers and products containing petroleum distillates.

• **Clean the lint filter before each load to prevent lint accumulation inside the dryer or in the room. DO NOT OPERATE THE DRYER WITHOUT THE LINT FILTER IN PLACE.**

• **Keep area around and underneath your appliance free from the accumulation of combustible materials, such as lint, paper, rags, chemicals, etc.**

• **Do not store items that may burn or melt (such as clothing, paper material, plastics or plastic containers, etc.) on top of the dryer during operation.**

• **The interior of the machine and the exhaust duct connection inside the dryer should be cleaned periodically by a qualified individual.**

• **Exhaust duct (see installation instructions). Use only metal duct inside dryer or for exhausting dryer to the outside.**

To minimize the possibility of injury.

• **Never reach into the dryer while the drum is moving. Before loading, unloading or adding clothes, wait until the drum has completely stopped.**

• **Close supervision is necessary if this appliance is used by or near children. Do not allow children to**

Important Safety Instructions (continued)

play inside, on or with this appliance or any discarded appliance. Dispose of discarded appliances and shipping or packing materials properly. Before discarding a dryer, or removing from service, remove the door of the drying compartment.

- Keep all laundry aids (such as detergents, bleaches, fabric softeners, etc.) out of the reach of children, preferably in a locked cabinet. Observe all warnings on container labels to avoid personal injury.

- Keep the floor around your appliances clean and dry to reduce the possibility of slipping.

- Do not dry fiberglass articles in your dryer. Skin irritation could result from the remaining glass particles that may be picked up by clothing during subsequent dryer uses.

- The laundry process can reduce the flame **retardancy** of fabrics. To avoid such a result, the garment

manufacturer's care instructions should be followed very carefully.

- Never climb on or stand on the dryer top or door.

- **Do not tamper with controls.**

- To minimize the possibility of electric shock, unplug this appliance from the power supply before attempting any maintenance or cleaning (except the removal and cleaning of the lint filter). **NOTE: Turning the Cycle Selector knob to an OFF position does NOT disconnect the appliance from the power supply.**

- Do not operate this appliance if it is damaged, malfunctioning, partially disassembled, or has missing or broken parts, including a damaged cord or plug.

- If yours is a gas dryer, it is equipped with an automatic electric ignition and does not have a pilot light. **DO NOT ATTEMPT TO LIGHT WITH A MATCH.** Burns may result from having your hand in the vicinity of the burner when the **automatic** ignition may turn on.

Dryer-applied fabric softeners or anti-static conditioners

You may wish to soften your laundered fabrics or reduce the static electricity in them. We recommend you use either a fabric softener in the wash cycle, according to the manufacturer's instructions for those products, or try a dryer-added product for which the manufacturer gives written assurance on the package that their product can be safely used in your dryer.

Service or performance problems caused by the use of these products are the responsibility of the manufacturers of those products and are not covered under the warranty of this appliance.

SAVE THESE INSTRUCTIONS

How to operate your dryer

WARNING—To reduce the risk of fire, electric shock, or injury to Persons, read the IMPORTANT SAFETY INSTRUCTIONS before operating this appliance.

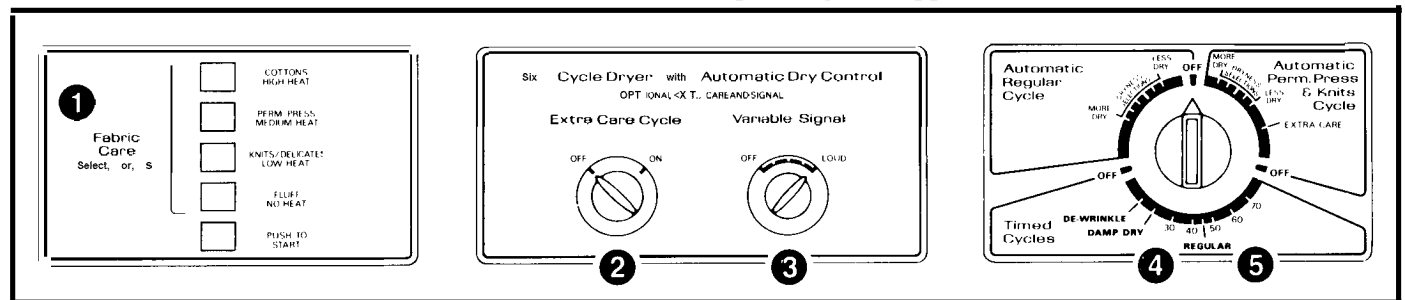

Load Your Dryer Properly

- Clean the lint filter each time the dryer is used. Always be sure the lint filter is in place. Don't use the dryer without it.

- Good sorting for the dryer begins at the washer. Generally, if clothes are sorted right for washing, they're

sorted right for drying. See page 8 for sorting help. (If you do mix various types of fabrics in your load, set the controls for the lighter-weight fabrics and remove when dry. Reset controls for the remaining heavier fabrics.)

Set the Controls

See the Controls Setting Guide on pages 6 and 7.

1 Fabric Care Selections

Push a button to select the proper heat for your load.

Fabric Care Selections	Should be used with cycles indicated ●		
	Automatic Regular Cycle	Automatic, Perm Press and Knits Cycles	Timed Cycles
Cottons High Heat	●		●
Perm Press Medium Heat		●	●
Knits/Delicates Low Heat		●	●
Fluff No Heat			●

2 Extra Care Cycle (Operates only with Automatic, Perm Press & Knits Cycles.)

Turn to ON if desired. To minimize wrinkles set in the clothes, the Extra Care cycle provides approximately 15 minutes of no-heat tumbling after the clothes are dry.

Use End-of-Cycle Signal. Signal will sound at five-minute intervals to remind you to remove the clothes.

3 Select End of Cycle Signal, if desired. (See below.)

@Turn Cycle Selector to desired cycle setting. The selector may be turned in either direction.

5 Press PUSH TO START button to start dryer. (Opening the door during operation stops the dryer. To re-start, close the door and press the START button.)

What is the difference between Timed & Automatic drying?

Timed Drying

When using the TIMED CYCLES, you select the number of minutes you wish the dryer to run and it turns off at the end of this time period.

Automatic Drying

When using the Automatic Cycles, the *Electronic Sensor Control system* continually senses the moisture in the tumbling clothes, determines when they are dried to your pre-selected setting, and terminates the cycle automatically. Refer to the CONTROLS SETTING GUIDE for recommended settings. The Cycle Selector will not advance until clothes have reached a certain degree of dryness.

Dryness selections guide for the automatic cycles

End-of-Cycle Signal

(Operates with any cycle.)

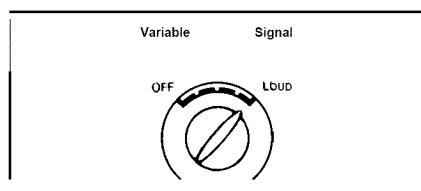

The Signal control can be set anywhere between OFF and LOUD, depending on desired sound level. The signal will sound just before the end of the cycle to remind you to remove the clothes.

To stop signal while sounding, turn Signal control to OFF or advance Cycle Selector to OFF.

The Signal should always be used when drying Polyester Knits or Permanent Press items which should be removed as soon as the dryer stops to help prevent setting of wrinkles.

The signal should also be used with the Extra Care Cycle.

Polyester Knits & Permanent Press drying tips

● **DO NOT OVERLOAD**—Garments being dried or dewrinkled should tumble freely.

● **REMOVE CLOTHES PROMPTLY**—To help prevent wrinkling, remove from the dryer promptly at the end of the drying cycles.

● **PLACE ON HANGERS**—Permanent Press and Polyester Knit garments look best if placed on hangers after drying.

Set to Middle Position

Automatic Regular Cycle

● For most normal loads.

Set toward MORE DRY

Automatic Regular Cycle

● For loads that include heavy-weight fabrics.
● If you desire to remove more moisture.

Set toward LESS DRY

Automatic Regular Cycle

● For lightweight fabric loads.
● If you desire to remove less moisture.
● For very small loads.

TURN THE PAGE
for Controls Setting Guide



Controls Setting Guide for different fabrics and loads

Load	Fabric Care/ Drying Selection*	Cycle	Cycle Setting
Cottons & Linens	Cottons High Heat	Automatic Regular Cycle or Timed Cycle	See Dryness Selection Guide on page 5. Set at REGULAR for dry; at DAMP-DRY for ironing.
Permanent Press, Treated Cottons, Blends with Cotton	Perm Press Medium Heat	Automatic Perm Press and Knits Cycle Timed Cycle	See Dryness Selection Guide on page 5. Use Extra Care Cycle if desired. DE-WRINKLE setting to de-wrinkle garments that have not been washed.
Synthetics—Polyester, Nylon, Acrylic Knits and Woven Fabrics Sturdy Delicate	Perm Press Medium Heat Knits/Delicates Low Heat	Automatic Perm Press and Knits Cycle	See Dryness Selection Guide on page 5. Use Extra Care Cycle if desired.
Silks and Wools, Blends including Silks and Wools	Knits/Delicates Low Heat	Automatic Perm Press and Knits Cycle	Set toward LESS DRY. See Dryness Selection Guide on page 5.
Rayon and Acetate	Knits/Delicates Low Heat	Automatic Perm Press and Knits Cycle	Set toward LESS DRY. See Dryness Selection Guide on page 5.
Down-filled garments, if machine washing and drying are recommended.	Cottons High Heat	Automatic Regular Cycle	See Dryness Selection Guide on page 5.
Baby Clothes—Sturdy: Diapers, Nightgowns, Shirts, Pads, Sheets, Receiving Blankets, Coveralls. See Special Instructions.	Cottons High Heat	Automatic Regular Cycle	See Dryness Selection Guide on page 5.
Baby Clothes—Delicate	Knits/Delicates Low Heat	Automatic Perm Press and Knits Cycle	See Dryness Selection Guide on page 5
Blankets—Wool, Part Wool, Cotton, Electric, Synthetic. See below under “Extra-large Items.”	Cottons High Heat	Timed Cycle	Set at 20 to 25 minutes
Curtains, Slipcovers, Draperies. DO NOT MACHINE DRY FIBERGLASS.	Cottons High Heat	Timed Cycle	For first setting, set at 20 minutes; for second setting, set at 15 minutes.
Chenille Bedspreads, Robes. See below under “Extra-large Items.”	Cottons High Heat	Timed Cycle	First setting—20 minutes; additional settings—5 minutes.
Rubber-coated Items, Laminated Fabrics, Vinyl, Plastics and Articles with Plastic Trim.	Fluff No Heat	Timed Cycle	Set for time desired.
Bathmats and Rugs	Cottons High Heat	Timed Cycle	First setting—20 minutes; additional settings—5 minutes.
Extra-large Items—Queen or King Size Sheets, Blankets or Spreads, Sleeping Bags, Insulated Jackets or Suits, Mattress Covers (Pads), Quilted Bedspreads.	Permanent Press Medium Heat	Timed Cycle	First setting—20 minutes; second setting—15 minutes; additional settings—5 minutes
Pillows—Feather and Polyester-filled (if manufacturer recommends they be dried in a dryer). See Special Instructions.	Cottons High Heat	Timed Cycle	Set at 70 minutes.

*The terms High, Medium and Low Heat are those usually found on fabric care labels. For best results, follow your fabric care labels.

NOTE: The Cycle Selector settings indicated above are to be used as a guide. You may find that best results are obtained for certain of your fabrics by setting the Cycle Selector to either side of the recommended settings.

Special Instructions

Do not dry non-colorfast items with whites or light-colored items.

Do not overload dryer; clothes should tumble freely. Remove promptly as soon as dryer stops; place clothes on hangers to minimize wrinkling.

Do not overload dryer; clothes should tumble freely. Remove promptly as soon as dryer stops, place clothes on hangers to minimize wrinkling.

Dry silks and wools in your dryer *only* if recommended by the garment manufacturer. Follow instructions carefully.

Tumble drying is mandatory. Down must be thoroughly dried to remove odor and prevent mildewing. Place two large, dry towels in the dryer to improve tumbling and shorten drying time. Be sure to dry thoroughly.

IMPORTANT. If children's sleepwear is made of Modacrylic, tumble dry only on Low Heat. High Heat can damage these fabrics. Check manufacturer's drying instructions.

See above instructions.

Place in dryer with 3 or 4 dry towels which have been heated for 5 minutes. Set timer for 20 to 25 minutes. Do not set control for more than 25 minutes. Do only one blanket at a time. Remove blanket at end of cycle and block blanket back to original shape. Press binding with warm iron. Allow to dry before storing.

Use dry towels as buffers. Set timer for 20 minutes. If items are still wet, reset for 15 minutes and check again. Items should be removed while still damp. Place slipcovers on furniture immediately. Hang draperies and curtains so that creases will fall out. Stop dryer periodically and check filter for excess lint. Remove and restart dryer.

Tumble on FLUFF (No Heat) setting as heat may cause alteration in shape, color and appearance of such articles

Stop dryer periodically and check filter for excess lint. Remove and restart dryer.

Special precautions must be taken for extra-large items. Set dryer for 20 minutes then check carefully. Set 15 minutes for second setting, check again; and 5 minutes for each additional setting. Make sure that article does not fill drum. Many large articles, when wet, have ample room in dryer, but as they dry and fluff up may not have room to tumble. Check carefully every few minutes and if article is still wet or damp and fills dryer, finish drying on line. Do not, under any circumstances operate dryer for longer times without checking. CAUTION: If large items do not have room to tumble, the air flow may be blocked which could result in scorching your valuable items. Many large items, like shag rugs, cannot be dried in home size dryers. *DO NOT tumble dry jackets containing Kapok.* (See filter cleaning instructions above,)

Check ticking for holes or weak seams where feathers or filling could escape. Dry no more than one pillow at a time and set dryer for maximum time. Stop dryer occasionally and shake pillows to redistribute filling for more even drying. Check pillows at end of drying time. If they are not completely dry, return them to dryer and reset for more drying time. Feather pillows dry very slowly and must be dried completely to prevent mildewing. *DO NOT tumble dry pillows containing Kapok.*

Refer to Garment Manufacturers' Care Labels

For more information on care labeling, send for "What's New About CARE LABELS?"

For sale by the Superintendent of Documents, U.S. Government Printing Office, Washington, DC. 20402.

How to sort the clothes

Normally, if you have sorted clothes correctly for washing, you will also have properly sorted drying loads.

Sort by surface texture

Separate

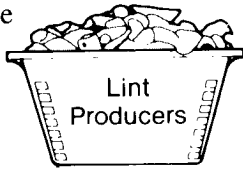

from



LINT PRODUCERS—such as terry toweling and chenille—give up lint. **LINT COLLECTORS**—such as man-made fibers and napped fabrics like velveteen and corduroy—attract lint, and must be dried separately.

Sort by fabric

Separate

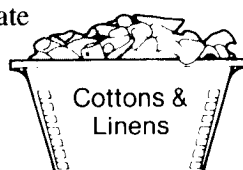

from



from

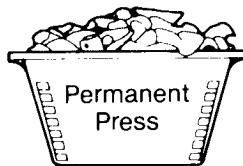

from

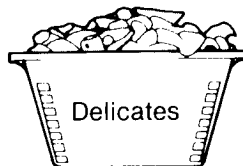

In addition to sorting to reduce lint collection, it is recommended that fabrics of similar construction be dried together whenever possible.

Sort by color

Separate

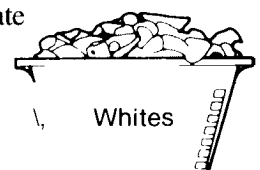

from

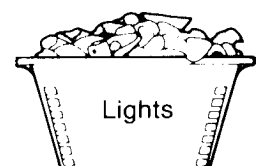

from

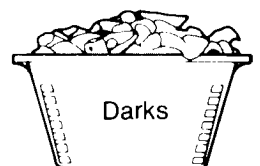

from

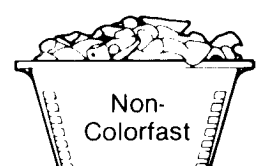

Sort by weight

Separate

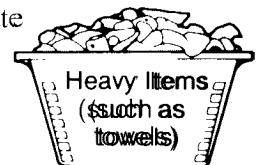

from

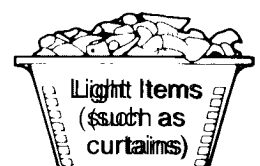

For information on tumble drying extra-large items and different fabrics and loads, see pages 6 and 7.

How to load the clothes

Don't overload your dryer. Crowded loads don't dry efficiently and clothes may be unnecessarily wrinkled.

Loads should look like this:

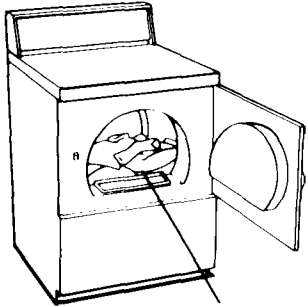

Drum with Cottons & Linens

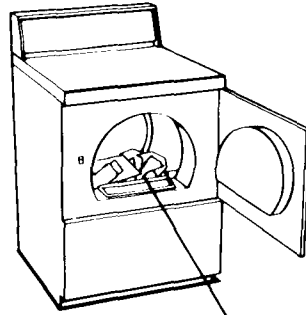

Drum with Permanent Press Load

Clean the lint filter before drying every load.

Clean lint filter (see shaded area) by putting your moistened fingers at the corner of filter and wiping in a downward motion all the way across to the other corner.

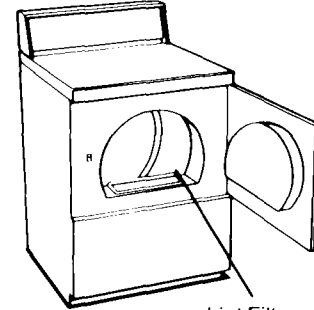

Lint Filter

For additional information on lint filter, see page 13.

Energy-Saving Tips

- Sort clothes by weight so you won't have to run an extra cycle for one or two heavier, slower-drying items. See page 8.
- Do not overload dryer. For efficient drying, clothes need to tumble freely.
- Use Automatic Drying Cycles whenever possible to help prevent overdrying and to save energy.

- To help prevent ironing, use Perm Press Medium Heat or Knits/Delicates Low Heat. Remove garments promptly at end of drying cycle and place on hangers.
- Dry your clothes in consecutive loads. Using a "warm" dryer will save energy.

- Clean dryer lint filter each time you dry.
- Clean dryer exhaust ducting at least once a year. A partially clogged exhaust can lengthen drying time.



Questions? Use This Problem Solver

PROBLEM	POSSIBLE CAUSE AND REMEDY
<p>DRYER WON'T START</p>	<ul style="list-style-type: none"> ● Dryer unplugged. Make sure power cord is plugged in. . No power to dryer. Check fuses and circuit breakers to make sure dryer is getting current. Most electric dryers use two. ● Controls improperly set. Make sure controls are set and START switch is pushed. Opening the door during operation stops the dryer. To re-start, close the door and push the START switch. ● Dryer door is open. Close door securely—dryer will not run with door open. ● Circuit is overloaded. Do not operate other appliances on the same electrical outlet or circuit while the dryer is operating.
<p>CLOTHES TAKE TOO LONG TO DRY</p>	<ul style="list-style-type: none"> ● Controls improperly set. Check all controls to make sure they are correctly set for the load you want to dry. See pages 4-7. ● Clogged lint filter. Remove and clean filter before every load. Periodically clean area under lint filter with vacuum cleaner. See page 13. ● Improper ducting. Make sure dryer is ducted in accordance with Installation Instructions. . Obstruction in exhaust ducting. Make sure ducting is clean and free of obstruction; make sure damper in outside wall cap operates easily. If flexible ducting is used, be sure it is not kinked and is properly installed according to Installation Instructions. ● Blown fuses or tripped circuit breakers. Check household fuses or circuit breakers. Most electric dryers use two. It is possible for one to be blown or tripped and the dryer still tumble without heat. ● Improper sorting. Do not mix heavy, hard-to-dry items with lightweight articles. ● Large loads of moisture-holding fabrics, such as beach towels, take a long time to remove moisture. ● Too many items in dryer. Dry only one washer load at a time. Do not combine loads. . Too few items in dryer. If drying only one article, add two more similar articles, even if dry, to insure proper tumbling.
<p>SHRINKAGE, GENERAL</p>	<ul style="list-style-type: none"> ● Some fabrics will shrink whether machine washed and tumble dried or washed by hand and drip dried; others may be safely washed but will shrink in a dryer. Follow Garment Manufacturers' Care Labels exactly. If in doubt, do not machine wash or tumble dry.

PROBLEM	POSSIBLE CAUSE AND REMEDY
SHRINKAGE, KNITS	<ul style="list-style-type: none"> ● Relaxation shrinkage can occur in knit fabrics that have been improperly stretched and elongated by the manufacturer. When this occurs, garment maybe pressed back into shape after each wash and dry cycle. . Progressive or delayed shrinkage is caused when starch or sizing (in some fabrics) is gradually removed by laundering. Maybe noticed in older garments that have been laundered many times without previous shrinkage. Treat as for Relaxation Shrinkage above. ● Shrinkage caused by overheating occurs in certain knit fabrics that have been heat-shaped. When washing, drying or ironing temperatures exceed the temperatures used to shape set, shrinkage may occur. This cannot be corrected, but it can be prevented by washing in cold or warm water; drying on low heat.
WRINKLING IN PERMANENT PRESS AND "NO-IRON" ITEMS	<ul style="list-style-type: none"> ● Leaving clothes in dryer after tumbling stops. Remove clothes promptly and hang them immediately. ● Too many items in dryer. Dry only one washer load at a time. Do not combine loads. ● Too few items in dryer. If drying only one article, add two or more similar articles, even if dry, to insure proper tumbling. ● Improper loads. Avoid laundering heavy Permanent Press items, such as work clothes, with lighter Permanent Press items, such as shirts or blouses. Do not wash or dry Permanent Press with regular laundry. ● Too many clothes in washer. Items must have room to move freely. Permanent Press loads should always be smaller than regular loads.. no more than medium loads. . Use of incorrect wash and dry cycles. Use Permanent Press Wash Cycle which provides a cool-down rinse to minimize wrinkling. Also, use Permanent Press Dry Cycle. ● Incorrect water level. Use large water level for medium load; medium level or half full for small load. . Washing repeatedly in too hot water. Wash in cool or warm water with plenty of detergent.

(continued next page) 

The Problem Solver (continued)

PROBLEM	POSSIBLE CAUSE AND REMEDY
WRINKLING IN PERMANENT PRESS AND "NO-IRON" ITEMS (continued)	<ul style="list-style-type: none"> ● Accumulation of lime scale due to use of carbonate detergents. If you must use a non-phosphate detergent, avoid the use of a high-carbonate detergent. ● Failure to use fabric softener. Proper use of fabric softener will minimize wrinkling. <p>To remove wrinkles:</p> <ul style="list-style-type: none"> . Retumble on "Permanent Press" setting. . Rerinse and dry on "Permanent Press" setting. . If unsuccessful, retumble on high heat for 10-12 minutes and hang immediately. . Iron carefully. ● Send to dry cleaners for pressing. ● Some wrinkles may remain which cannot be removed? <p>*NOTE: If you follow good laundry procedures and Permanent press clothes still come out wrinkled, the finish may not be good quality. Also, in permanent press synthetic/cotton blends, the cotton portion of the fabric can eventually wear away leaving only the synthetic. Since it's the cotton portion which is treated for Permanent Press, a loss or decrease of Permanent Press performance will result.</p>

If you need more help. . call. toll free:
GE Answer Center™™™™ ‘
800.626.2000
 consumer information service



Care and Cleaning

USER MAINTENANCE INSTRUCTIONS

Good dryer care

The Drum. Porcelain enamel drum is rust-resistant and requires no special care.

The Exterior. Wipe off any spills or washing compounds. Wipe or dust with damp cloth. Try not to strike the surface with sharp objects.

The Lint Filter. Wipe lint filter before every use as described on page 9. Periodically lint filter should be removed and suction hose from vacuum cleaner should be inserted into the opening. See below.

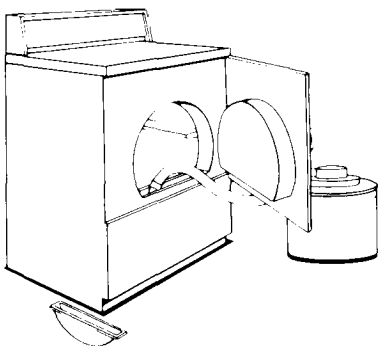

Do not obstruct the flow of combustion and ventilating air. The air intake is located on rear of dryer.

Dryer Exhaust: Inspect and clean the dryer exhaust ducting at least once a year.

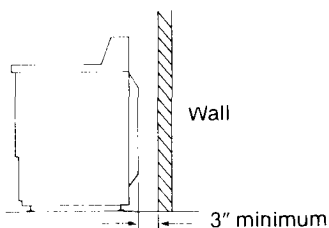

Make sure there is at least 3" clearance from rear dryer louvers to the wall.

To store dryer for a short period of time, disconnect power supply and clean lint filter.

Do not store dryer where it will be exposed to the weather.

CAUTIONS:

- Before having your electric dryer connected in your new residence, be sure your licensed electrician confirms that the supply voltage matches the voltage specified on the rating plate.
- Dryer control panel and finishes may be damaged by some laundry pre-treatment soil and stain remover products if such products are sprayed on or have direct contact with the dryer.

Apply these pre-treatment products away from the dryer. The fabric may then be washed and dried normally. Damage to your dryer caused by pre-treatment products is not covered by your warranty.

How to replace Drum Lamp

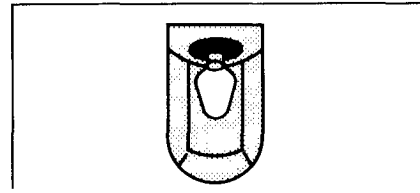

BEFORE REPLACING LIGHT BULB, BE SURE TO UNPLUG THE DRYER POWER CORD. Unscrew the bulb and replace it with the same type 10 watt bulb.



Notes



We'll Be There

With the purchase of your new GE appliance, receive the assurance that if you ever need information or assistance from GE, we'll be there. All you have to do is call—toll-free!

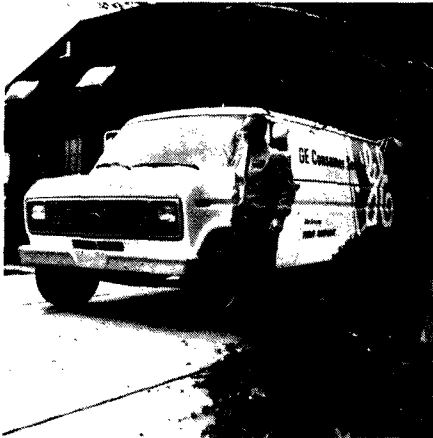

In-Home Repair Service

800-GE-CARES
(800-432-2737)

A GE Consumer Service professional will provide expert repair service, scheduled at a time that's convenient for you. Many GE Consumer Service company-operated locations offer you service today or tomorrow, or at your convenience (7:00 a.m. to 7:00 p.m. weekdays, 9:00 a.m. to 2:00 p.m. Saturdays). Our factory-trained technicians know your appliance inside and out—so most repairs can be handled in just one visit.



Service Contracts

800-626-2224

You can have the secure feeling that GE Consumer Service will still be there after your warranty expires. Purchase a GE contract while your warranty is still in effect and you'll receive a substantial discount. With a multiple-year contract, you're assured of future service at today's prices.

Parts and Accessories

800-626-2002

Individuals qualified to service their own appliances can have needed parts or accessories sent directly to their home, free of shipping charge! The GE parts system provides access to over 47,000 parts.. and all GE Genuine Renewal Parts are fully warranted. VISA, MasterCard and Discover cards are accepted.

User maintenance instructions contained in this booklet cover procedures intended to be performed by any user. Other servicing generally should be referred to qualified service personnel. Caution must be exercised, since improper servicing may cause unsafe operation.



GE Answer Center[®]

800.626.2000

Whatever your question about any GE major appliance, GE Answer Center[®] information service is available to help. Your call—and your question—will be answered promptly and courteously. And you can call any time. GE Answer Center[®] service is open 24 hours a day, 7 days a week.

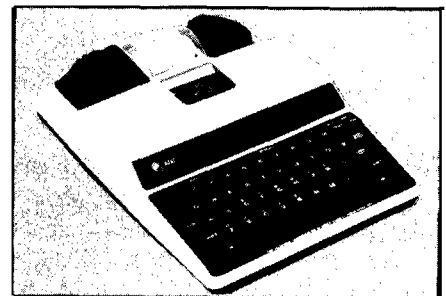

Telecommunication Device for the Deaf

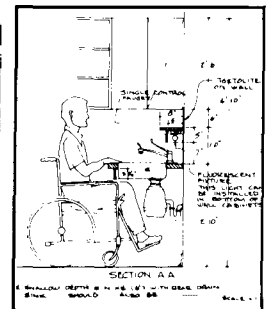

For Customers With Special Needs...

800.626.2000

Upon request, GE will provide Braille controls for a variety of GE appliances, and a brochure to assist in planning a barrier-free kitchen for persons with limited mobility. To obtain these items, free of charge, call 800.626.2000.

Consumers with impaired hearing or speech who have access to a TDD or a conventional teletypewriter may call 800-TDD-GEAC (800-833-4322) to request information or service.

YOUR GE AUTOMATIC CLOTHES DRYER WARRANTY

Save proof of original purchase date such as your sales slip or **cancelled** check to establish warranty period.

WHAT IS COVERED

FULL ONE-YEAR WARRANTY

For one year from date of original purchase, we will provide, free of charge, parts and service labor in your home to repair or replace **any part of the dryer** that fails because of a manufacturing defect.

This warranty is extended to the original purchaser and any succeeding owner for products purchased for ordinary home use in the 48 mainland states, Hawaii and Washington, D.C. in Alaska the warranty is the same except that it is LIMITED because you must pay to ship the product to the service shop or for the service technician's travel costs to your home.

All warranty service will be provided by our Factory Service Centers or by our authorized Customer Care® servicers during normal working hours.

Look in the White or Yellow Pages of your telephone directory for GENERAL ELECTRIC COMPANY, GENERAL ELECTRIC FACTORY SERVICE, GENERAL ELECTRIC-HOTPOINT FACTORY SERVICE or GENERAL ELECTRIC CUSTOMER CARE® SERVICE.

WHAT IS NOT COVERED

● Service trips to your home to teach you how to use the product.

Read your Use and Care material.

If you then have any questions about operating the product, please contact your dealer or our Consumer Affairs office at the address below, or call, toll free:

GE Answer Center™
800.626.2000
consumer information service

● Improper installation.

If you have an installation problem, contact your dealer or installer. You are responsible for providing adequate electrical, exhausting and other connecting facilities.

. Replacement of house fuses or resetting of circuit breakers.

. Failure of the product if it is used for other than its intended purpose or used commercially.

● Damage to product caused by accident, fire, floods or acts of God.

WARRANTOR IS NOT RESPONSIBLE FOR CONSEQUENTIAL DAMAGES.

Some states do not allow the exclusion or limitation of incidental or consequential damages, so the above limitation or exclusion may not apply to you. This warranty gives you specific legal rights, and you may also have other rights which vary from state to state. To know what your legal rights are in your state, consult your local or state consumer affairs office or your state's Attorney General.

Warrantor: General Electric Company

**If further help is needed concerning this warranty, write:
Manager—Consumer Affairs, GE Appliances, Louisville, KY 40225**

Part No. 113 D5497P155
Pub. No. 49-9655

DDE8200G
DDG8280G