

Operating and installation instructions Dialog oven



To avoid the risk of accidents or damage to the appliance it is **essential** to read these instructions before it is installed and used for the first time.



Contents

Warning and safety instructions	6
Caring for the environment	18
Guide to the appliance	19
Controls	20
On/Off sensor control	21
Sensor controls	21
Touch display	22
Symbols	23
Using the appliance	24
Selecting a menu option	24
Scrolling	24
Exiting a menu	24
Changing a value or setting	24
Changing values or settings during a cooking programme	24
Changing a setting in a list	24
Entering numbers with the roller	24
Entering numbers using the numerical keypad	25
Changing the setting with a segment bar	25
Entering letters	25
Displaying Help	25
Features	26
Data plate	26
Scope of delivery	26
Accessories supplied and available to order	26
Safety features	29
PerfectClean treated surfaces	29
Pyrolytic accessories	29
Before using for the first time	30
Miele@home	30
Basic settings	31
Heating up the Dialog oven for the first time and rinsing the steam injection system	32
Settings	34
Settings overview	34
Opening the “Settings” menu	36
Language 	36
Time	36
Date	36
QuickTouch	36

Start screen	37
Brightness	37
Colour scheme	37
Volume.....	37
Units	38
Cooling fan run-on	38
Pyrolytic.....	38
Recommended temperatures.....	38
Safety	38
Catalyser	39
Network.....	39
Miele@home.....	39
Remote control.....	41
SuperVision	41
Showroom programme.....	42
Factory default.....	42
Alarm + minute minder	43
Using the Alarm function.....	43
Using the minute minder function	44
M Chef	45
Principle of operation	45
Gourmet units.....	45
Intensity	45
Adapting existing recipes to M Chef functions	46
Function.....	46
Temperature	46
Gourmet units.....	46
Intensity	46
Cooking duration.....	46
Shelf level.....	46
Gourmet Profi and Gourmet assistant.....	47
Main and sub-menus	48
Suitable cookware for M Chef functions.....	50
Suitable crockery.....	50
Unsuitable crockery.....	51
Energy saving tips	52

Contents

Operation	54
Changing values and settings for a cooking programme.....	55
Changing the temperature and core temperature.....	55
Changing the number of Gourmet units.....	55
Changing the intensity.....	56
Setting cooking durations.....	57
Cancelling a cooking programme.....	58
Pre-heating the oven.....	58
Rapid heat-up.....	59
Pre-heat.....	60
Crisp function.....	61
Change type of heating.....	61
Change function.....	61
Functions using moisture	62
Starting a cooking programme using moisture.....	63
Evaporate residual moisture.....	66
Automatic programmes	68
Using automatic programmes.....	68
Usage notes.....	68
Search.....	69
Special applications	70
Defrost.....	70
Drying.....	72
Heat crockery.....	73
Prove dough.....	73
Low temp. cooking.....	74
Sabbath programme.....	76
Frozen food/Ready meals.....	77
User programmes	78
MyMiele	80
Baking	81
Tips on baking.....	81
Notes on the cooking charts.....	82
Notes on the functions.....	82
Roasting	84
Tips for roasting.....	84
Notes on the cooking charts.....	84
Notes on the functions.....	85
Food probe.....	86

Grilling	89
Tips for grilling	89
Notes on the cooking charts	90
Notes on the functions	91
Cleaning and care	92
Unsuitable cleaning agents	92
Removing normal soiling	93
Removing stubborn soiling.....	94
Cleaning the oven compartment by means of Pyrolytic	95
Descale.....	98
Problem solving guide	102
Service	107
Contact in the event of a fault	107
Warranty	107
Installation	108
Installation dimensions.....	108
Installation in a tall or base unit.....	108
Side view	109
Connections and ventilation.....	110
Installing the Dialog oven	111
Electrical connection	112
Cooking charts	114
Batter	114
Shortcrust pastry.....	115
Yeast dough	116
Quark dough.....	117
Sponge mixture	117
Choux pastry, puff pastry, meringue.....	118
Savoury dishes	119
Beef	120
Pork	122
Veal.....	124
Lamb, game	125
Poultry, fish.....	126
Gourmet Assistant  overview	127
Overview of Automatic programmes 	132
Conformity declaration	137
EU Conformity declaration	137
UK Conformity declaration	137
Copyright and licences	138

Warning and safety instructions

This Dialog oven complies with all current local and national safety requirements. Inappropriate use can, however, lead to personal injury and material damage.

Read the operating and installation instructions carefully before using the Dialog oven. They contain important information on safety, installation, use and maintenance. This prevents both personal injury and damage to the Dialog oven.

In accordance with IEC/EN 60335-1 you are expressly advised to read and follow all instructions in the following sections of this manual: Warning and Safety, Installation and Electrical connection.

Miele cannot be held liable for damage caused by non-compliance with these instructions.

Keep these instructions in a safe place and pass them on to any future owner.

Appropriate use

▶ This Dialog oven is intended for use in domestic households and similar working and residential environments.

▶ This Dialog oven is not intended for outdoor use.

▶ The Dialog oven is intended for domestic use only to cook, bake, roast, grill, defrost, bottle and dry food.

All other types of use are not permitted.

▶ Fire hazard due to flammable materials. If flammable items were dried in the Dialog oven, the moisture in the items would evaporate. This could cause the materials to dry out and possibly self-ignite. Never use the Dialog oven to store or dry items which could ignite easily.

▶ This Dialog oven can only be used by people with reduced physical, sensory or mental capabilities or lack of experience and knowledge if they are supervised whilst using it. They may only use the Dialog oven unsupervised if they have been shown how to use it in a safe manner. They must be able to recognise and understand the dangers of misuse.

- ▶ The oven compartment is equipped with special lamps to cope with particular conditions (e.g. temperature, moisture, chemical resistance, abrasion resistance and vibration). These special lamps must only be used for the purpose for which they are intended. They are not suitable for room lighting. Replacement lamps may only be fitted by a Miele authorised technician or by the Miele Customer Service Department.
- ▶ The Dialog oven contains 2 light sources corresponding to energy efficiency class G.

Safety with children

- ▶ Children under 8 years of age must be kept away from the Dialog oven unless they are constantly supervised.
- ▶ Children aged 8 and older may only use the Dialog oven without supervision if they have been shown how to use it in a safe manner. Children must be able to understand and recognise the possible dangers caused by incorrect operation.
- ▶ Children must not be allowed to clean or maintain the Dialog oven unsupervised.
- ▶ Children should be supervised in the vicinity of the Dialog oven. Never allow children to play with the Dialog oven.
- ▶ Risk of suffocation due to packaging material. Whilst playing, children may become entangled in packaging material (such as plastic wrapping) or pull it over their head, presenting the risk of suffocation.
Keep packaging material away from children.
- ▶ Risk of injury caused by hot surfaces. Children's skin is far more sensitive to high temperatures than that of adults. External parts of the Dialog oven such as the door glass, control panel and the vent become quite hot.
Do not let children touch the Dialog oven when it is in operation.

Warning and safety instructions

- ▶ Risk of injury caused by hot surfaces. Children's skin is far more sensitive to high temperatures than that of adults. The Dialog oven gets much hotter during pyrolytic cleaning than during normal use. Do not let children touch the Dialog oven during Pyrolytic cleaning.
- ▶ Risk of injury from the open door. The oven door can support a maximum weight of 15 kg. Children could injure themselves on an open door. Do not let children sit on the open door, lean against it or swing on it.

Technical safety

- ▶ Unauthorised installation, maintenance and repairs can cause considerable danger for the user. Installation, maintenance and repairs must only be carried out by a Miele authorised technician.
- ▶ Damage to the Dialog oven can compromise your safety. Check the Dialog oven for visible signs of damage. Do not use a damaged Dialog oven.
- ▶ Temporary or permanent operation on an autonomous power supply system or a power supply system that is not synchronised with the mains power supply (e.g. island networks, back-up systems) is possible. A prerequisite for operation is that the power supply system complies with the specifications of EN 50160 or an equivalent standard. The function and operation of the protective measures provided in the domestic electrical installation and in this Miele product must also be maintained in isolated operation or in operation that is not synchronised with the mains power supply, or these measures must be replaced by equivalent measures in the installation. As described, for example, in the current version of BS OHSAS 18001-2 ISO 45001.



Warning and safety instructions

- ▶ Operating a damaged Dialog oven can result in electro-magnetic leakage and present a hazard to the user as well as affecting the functionality of electronic devices such as mobile phones. Do not use the Dialog oven if:
 - The door is warped.
 - The door hinges are loose.
 - The door seals are damaged.
 - Holes or cracks are visible in the casing, the door or the oven compartment walls.
- ▶ The electrical safety of the Dialog oven can only be guaranteed when continuity is complete between it and an effective earthing system. It is most important that this basic safety requirement is fulfilled. If in doubt, the electrical installation should be checked by a qualified electrician.
- ▶ Ensure that the connection data on the Dialog oven's data plate (voltage and frequency) match the mains electricity supply. This data must correspond in order to avoid the risk of damage to the Dialog oven. Compare this before connecting the appliance to the mains. If in any doubt, consult a qualified electrician.
- ▶ Multi-socket adapters and extension leads do not guarantee the required safety of the appliance. Do not use these to connect the Dialog oven to the mains electricity supply.
- ▶ For safety reasons, this Dialog oven may only be used after it has been built in.
- ▶ This Dialog oven must not be installed and operated in mobile installations (e.g. on a ship).
- ▶ Risk of injury due to electric shock. Any contact with live connections or tampering with the electrical or mechanical components of the Dialog oven will endanger your safety and may lead to appliance malfunctions.
Do not open the Dialog oven casing under any circumstances.

Warning and safety instructions

- ▶ While the Dialog oven is under warranty, repairs should only be undertaken by a Miele authorised service technician. Otherwise the warranty is invalidated.
- ▶ Miele can only guarantee the safety of the oven when original Miele spare parts are used. Faulty components must only be replaced by original spare parts.
- ▶ There are 2 seals around the door. These seals must never be removed.
- ▶ If the connection cable is damaged, it must be replaced with a special connection cable by a Miele authorised service technician (see “Installation”, “Electrical connection”).
- ▶ During installation, maintenance and repair work, the Dialog oven must be completely disconnected from the mains electricity supply. To ensure this, do one of the following:
 - Disconnect the mains fuse
 - Completely unscrew the screw-out fuse (in countries where this is applicable)
 - Pull out the plug (if one is present) at the wall socket. To do this, pull the plug and not the mains connection cable.
- ▶ The Dialog oven requires a sufficient supply of cool air for efficient operation. Make sure that the supply of cool air is not hindered in any way (e.g. by fitting heat insulation strips in the housing unit). Furthermore, the required supply of cool air must not be excessively heated by other heat sources (e.g. solid fuel stoves).
- ▶ If the Dialog oven is built in behind a furniture front (e.g. a door), do not close the furniture front while the Dialog oven is in use. Heat and moisture can build up behind the furniture front when closed. This can result in damage to the Dialog oven, the housing unit and the floor. Leave the furniture door open until the Dialog oven has cooled down completely.

Correct use

- ▶ Risk of injury caused by hot surfaces. The Dialog oven gets hot when it is being used. You could burn yourself on the heater elements, oven compartment, accessories or food. Use oven gloves when placing hot food in the appliance or removing it and when working in the hot oven compartment.
- ▶ Due to the high temperatures radiated, objects left near the Dialog oven when it is switched on could start to burn. Do not use the Dialog oven to heat up the room.
- ▶ Oils and fats can ignite if allowed to overheat. Never leave the Dialog oven unattended when cooking with oil or fats. Do not use the Dialog oven for deep-fat frying. Never attempt to put out oil or fat fires with water. Switch the Dialog oven off and extinguish the flames by leaving the door closed.
- ▶ Grilling food for excessively long cooking durations can cause it to dry out with the risk of catching fire. Do not exceed the recommended cooking durations.
- ▶ Please be aware that durations when using an M Chef function are often considerably shorter when cooking, reheating and defrosting than when using a conventional function. Excessively long cooking times can lead to food drying out and burning, or could even cause it to catch fire.
Never use an M Chef function or a Grill function to dry flowers or herbs. Instead, use the Fan plus  or Conventional heat  function.
- ▶ If using alcohol in your recipes, please be aware that high temperatures can cause the alcohol to evaporate. The vapour can catch fire on hot heating elements.
- ▶ When using residual heat to keep food warm, corrosion from high air humidity and condensation can occur in the Dialog oven. This can also cause damage to the control panel, worktop and surrounding kitchen furniture. Keep the Dialog oven on and select the lowest temperature available for the selected function. The cooling fan will then continue to run automatically.

Warning and safety instructions

▶ Food which is stored in the oven compartment or left in it to be kept warm can dry out and the moisture released can lead to corrosion damage in the Dialog oven. Always cover food that is left in the oven to keep warm.

▶ An accumulation of heat can cause the enamel on the floor of the oven to crack or flake off.

Never line the floor of the oven compartment with aluminium foil or oven liners.

If you wish to place crockery on the floor of the oven compartment during cooking, or place crockery on the floor of the oven compartment to heat it up, you can do so, but only with the Fan plus  function, without the Rapid heat-up function.

▶ The oven compartment floor can become damaged by items being pushed around on it. When placing pots, pans or crockery on the oven compartment floor, ensure that you avoid pushing them around.

▶ Risk of injury caused by steam. Pouring a cold liquid onto a hot surface creates steam, which can cause severe scalding. The sudden temperature change can also cause damage to hot enamelled surfaces. Never pour cold liquids directly onto hot enamelled surfaces.

▶ Danger of injury caused by steam. During cooking processes using moisture and during the residual moisture evaporation process steam is produced which can cause serious injury by scalding. Never open the door while steam is being injected or during the evaporation of residual water.

▶ It is important that the temperature in the food being cooked is evenly distributed and sufficiently high.

This can be achieved by stirring or turning the food, and observing a sufficiently long standing time (see charts), which should be added to the time needed for reheating, defrosting or cooking.

During the standing time, the temperature is distributed evenly in the food.

Warning and safety instructions

▶ Risk of injury caused by hot food. When heating food up, the heat is created directly in the food itself. For this reason the crockery will remain cooler than the food (except when using oven-proof stoneware). The crockery is only warmed by the heat of the food. Before serving, always check the temperature of the actual food itself after taking it out of the oven. The temperature of the container is not an indication of the temperature of the food or liquid in it. **This is particularly important when preparing food for babies, children, and the elderly or infirm.** After reheating food, especially food for babies and small children, stir the food or shake the container and check that the temperature does not pose any danger of burning. Double check after it has been left to stand.

▶ The Dialog oven is not suitable for cleaning or disinfecting items. Items can get extremely hot. There is a risk of burning when items are removed from the oven.

▶ Risk of injury from increased pressure in closed containers or bottles. Pressure can build up during reheating in sealed containers or bottles, causing them to explode. Never cook or reheat food or liquids in sealed containers or bottles. Open containers beforehand. In the case of baby bottles, the screw top and teat must be removed.

▶ When heating food, and in particular liquids, the boiling point may be reached without the production of the typical bubbles. The liquid does not boil evenly throughout. This boiling delay can result in the liquid boiling over explosively. Take care when taking the container out of the oven, as the hot liquid can cause severe scalding. Under certain circumstances, the pressure can be so high that the door opens automatically.

Stir liquids well before reheating or cooking. After reheating, wait at least 20 seconds before removing the container from the oven. In addition, a glass rod or similar item, if available, can be placed in the container during reheating.

Warning and safety instructions

▶ If you cook eggs without their shells, the yolks could explode due to the resulting pressure.

Prick the yolk several times before cooking to avoid this.

▶ Eggs heated in their shells can burst, even after they have been taken out of the oven.

Eggs can only be cooked in their shells in a specially designed egg-boiling device. Do not reheat hard boiled eggs using M Chef functions.

▶ Food with a thick skin or peel, such as tomatoes, sausage, potatoes and aubergines can burst when heated or cooked. Pierce or score the skin of these types of food several times to allow steam to escape.

▶ Do not use thermometers containing mercury or liquid as these are not suitable for use with very high temperatures and break very easily.

Only use the Miele food probe supplied with the appliance to measure the temperature of the food.

▶ Cushions or pads filled with cherry kernels, gel, etc., such as those used in aromatherapy, can ignite when heated even after they have been removed from the oven.

Do not heat these kinds of cushions and pads up in the Dialog oven.

▶ Crockery and lids with hollow handles or knobs can collect moisture in the hollow spaces. When the moisture evaporates, pressure can build up and the item can explode. If the hollow recess is sufficiently ventilated, the item can be used.

Do not use crockery with hollow knobs or handles for cooking with the M Chef functions.

▶ Plastic containers which are not heat-resistant melt at high temperatures and could ignite and damage the Dialog oven.

Only use plastic containers that are heat-resistant. Follow the instructions from the crockery manufacturer.

Warning and safety instructions

▶ Unsuitable crockery can suffer damage and cause damage to the Dialog oven.

Do not use any closed metal containers, aluminium foil, cutlery, metal-plated crockery, lead crystal glassware, temperature-sensitive plastics, metal clips or plastic or paper covered wire ties. (see “Suitable cookware for M Chef functions”).

Do not leave the Dialog oven unattended when heating or cooking food in containers made of wood or other inflammable materials.

▶ Fire hazard due to containers made of flammable materials.

Plastic disposable containers must meet the requirements specified in “Suitable cookware for M Chef functions”.

Do not leave the Dialog oven unattended when heating or cooking food in disposable containers made of plastic, paper or other inflammable materials.

▶ Heat-retaining packaging usually contains a thin layer of aluminium foil that reflects electro-magnetic waves. As a result, the paper surrounding the aluminium foil can become so hot that it combusts.

Do not use heat-retaining packaging, such as bags for grilled chicken, for warming food with M Chef functions.

▶ Reheating food in closed containers results in an increase in pressure, which can cause them to explode.

Do not use tins for reheating food.

▶ Risk of injury from the open door. You could bang into the open door or trip over it. Avoid leaving the door open unnecessarily.

▶ The door can support a maximum load of 15 kg. Do not lean or sit on the door when open, or place heavy items on it. Make sure that nothing gets trapped between the door and the oven compartment. Doing so could damage the Dialog oven.

Warning and safety instructions



The following applies to stainless steel surfaces:

- ▶ Adhesives will damage the stainless steel surface and cause it to lose its dirt-repellent protective coating. Do not use sticky notes, adhesive tape or other types of adhesive on the stainless steel surface.
- ▶ Magnets can cause scratches. Do not use the stainless steel surface as a magnetic notice board.

Cleaning and care

- ▶ Risk of injury due to electric shock. The steam from a steam cleaning appliance could reach live electrical components and cause a short circuit. Do not use a steam cleaner to clean the appliance.
- ▶ Scratches on the door glass can cause the glass to break. Do not use abrasive cleaners, hard sponges, brushes or sharp metal tools to clean the door glass.
- ▶ Coarse soiling in the oven compartment can cause thick smoke to develop. Coarse soiling should be removed from the oven compartment before running the pyrolytic cleaning programme.
- ▶ In warm, moist environments, there is a higher probability of pest infestations (such as cockroaches). Ensure the Dialog oven and the area surrounding it are always kept clean.
Damage caused by pests is not covered by the warranty.

Accessories

- ▶ Only use original Miele accessories. If other parts are used, warranty, performance and product liability claims will be invalidated.
- ▶ Miele will guarantee to supply functional spare parts for a minimum of 10 years and up to 15 years following the discontinuation of your Dialog oven.
- ▶ The Miele Gourmet oven dish HUB 62-22 (if available) must not be inserted into shelf level 1. This will damage the floor of the oven. Do not place a Miele oven dish on the upper support of shelf level 1 either as it will not be secured by the non-tip safety notches. As a general rule, use shelf level 2.
- ▶ With M Chef functions, metal lids reflect electro-magnetic waves and hence prevent cooking. Oven dishes and pots must be used without a lid or with a glass lid with M Chef functions.
- ▶ Only use the Miele food probe supplied with the appliance. If it is faulty, it must be replaced with a new original Miele food probe.
- ▶ The plastic on the food probe can melt at very high temperatures. Do not use the food probe when using the grill functions. (Exceptions: M Chef + Fan grill  and Fan grill ). Do not store the food probe in the oven compartment when it is not being used.
- ▶ Accessories that are not suitable for pyrolytic cleaning will be damaged by the high temperatures. Remove all accessories that are not suitable for pyrolytic cleaning from the oven compartment before starting the pyrolytic cleaning programme. This also applies to optional accessories that are not suitable for pyrolytic cleaning (see “Cleaning and care”).

Caring for the environment

Disposing of the packaging material

The packaging material is used for handling and protects the appliance from transport damage. The packaging material used is selected from materials which are environmentally friendly for disposal and can generally be recycled.

Recycling the packaging material reduces the use of raw materials. Use material-specific collection points for valuable materials and take advantage of return options. Your Miele dealer will take the packaging material away.

Disposing of your old appliance

Electrical and electronic appliances contain many valuable materials. They also contain certain materials, compounds and components which were essential for their correct functioning and safety. These could be hazardous to human health and to the environment if disposed of with household waste or if handled incorrectly. Please do not, therefore, dispose of your old appliance with household waste.



Instead, please make use of officially designated collection and disposal points to dispose of and recycle electrical and electronic appliances in your local community, with your dealer or with Miele, free of charge. By law, you are solely responsible for deleting any personal data from the old appliance prior to disposal. You are legally obliged to remove any old batteries which are not securely enclosed by the appliance and to remove any lamps without destroying them, where this is possible. These must be taken to a suitable collection point where they can be handed in free of charge. Please ensure that your old appliance poses no risk to children while being stored for disposal.



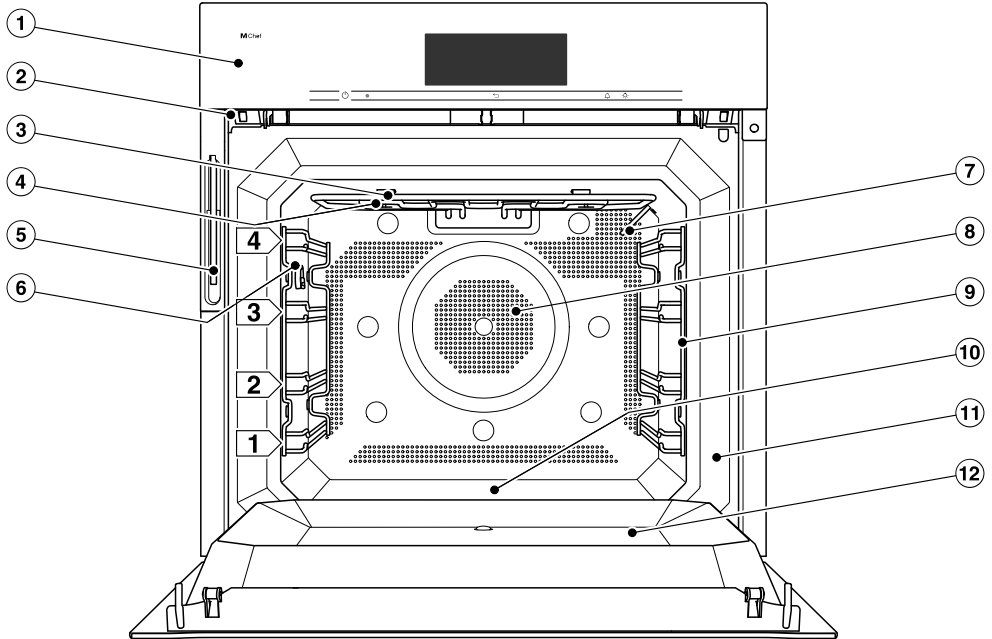

Dialog oven

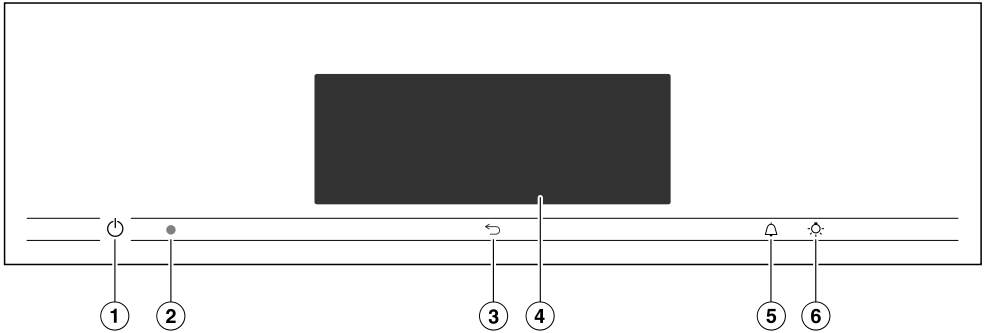

- ① Controls with M Chef logo
- ② Door lock for pyrolytic cleaning
- ③ Top heat/grill element with antenna for M Chef functions
- ④ Steam inlet openings
- ⑤ Water intake pipe for the steam injection system
- ⑥ Connection socket for the food probe
- ⑦ Temperature sensor
- ⑧ Air inlet for the fan with ring heating element behind it
- ⑨ Side runners with 4 shelf levels
- ⑩ Oven floor with bottom heat element underneath it
- ⑪ Front frame with data plate
- ⑫ Door

Controls



- ① Recessed on/off sensor 
For switching the Dialog oven on and off
- ② Optical interface
(For Miele Service only)
- ③  sensor control
To go back a step
- ④ Touch display
For displaying information and for operation
- ⑤  sensor control
For setting the minute minder or alarms
- ⑥  sensor control
For switching the oven interior lighting on and off

On/Off sensor control





The  On/Off sensor control is recessed and reacts to touch.

It is used for switching the Dialog oven on and off. As soon as the Dialog oven is switched on, the M Chef logo lights up on the top left-hand side of the control panel.

Sensor controls

The sensor controls react to touch. Every touch of a sensor control is confirmed with an audible tone. This audible tone can be switched off if required, by selecting Volume | Keypad tone | Off.

If you want the sensor controls to respond even when the Dialog oven is switched off, select QuickTouch | On with time.

Sensor control	Function
	Depending on which menu you are in, this will take you back a level or back to the main menu.
	If a menu appears in the display or if a cooking programme is in progress, you can use this sensor control to set a minute minder (e.g. when boiling eggs) or an alarm (a specific time) at any point (see “Alarm and minute minder”).
	If a menu is showing in the display or if a cooking programme is running when you open the door, touching the  sensor control will switch the oven interior lighting on or off. The oven interior lighting switches off automatically after about 1 minute.

Controls

Touch display

The sensitive surface of the touch display can be scratched by pointed or sharp objects, e.g. pens.

Only touch the display with your fingers.

Make sure that water cannot get behind the touch display.

The touch display is split into multiple areas.

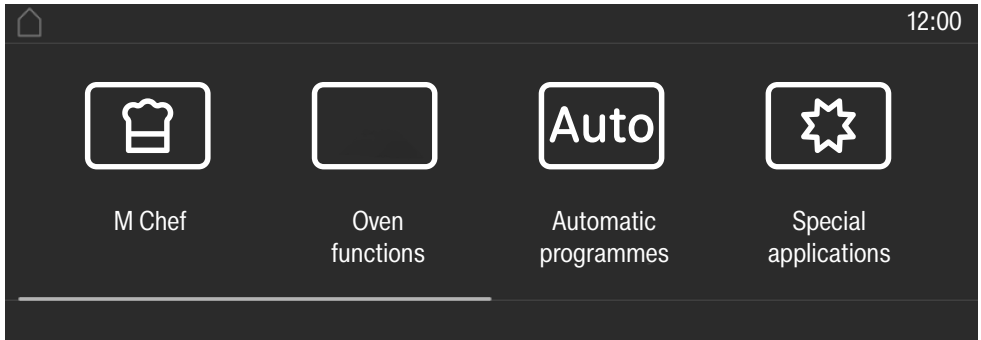

The menu path appears on the left of the **header**. The individual menu options are separated by a vertical line. ... I indicates that there are more options available, which are not visible because there is not enough space in the display.

If you touch a menu name in the header, the display will switch to that menu. To switch to the start screen, touch .

The time of day is shown on the right of the header. Additional symbols may also appear; for example: SuperVision .

The current menu and menu options are shown in the **centre**. You can scroll to the right or left by swiping your finger across the display to the right or left. Touch a menu option to select it (see “Operation”).

The operation fields that appear in the **footer** vary according to the menu that is selected; for example: Change or OK.

Symbols

The following symbols may appear in the display:

Symbol	Meaning
	This symbol indicates that there is additional information and advice about using the appliance. Press the <i>OK</i> sensor control to confirm the information.
	This indicates that there are more options available, which are not visible because there is not enough space in the display.
	Alarm
	Minute minder
	Some settings, e.g. display brightness and buzzer volume are selected using a bar chart.
	The system lock or sensor lock is on (see “Settings – Safety”). The controls are locked.
	Core temperature when using the food probe
	Remote control (only appears if you are in the Miele@home system and have selected <i>Remote control On</i>).
	SuperVision (only appears if you are in the Miele@home system and have selected <i>SuperVision SuperVision display On</i>)

Using the appliance

You operate the Dialog oven via the touch display by touching the desired menu option.

Each time you touch a possible option, the relevant characters (word and/or symbol) light up **orange**.

Fields for confirming an operating step are highlighted in **green** (e.g. *OK*).

Selecting a menu option

- Touch the field or value you want in the display.

Scrolling

You can scroll left or right.

- Swipe across the screen. To do this, place your finger on the touch display and swipe it in the direction you want.

The bar at the bottom shows you where you are in the current menu.

Exiting a menu

- Touch the ↩ sensor control or touch the ... I symbol in the menu path.
- Touch the ⏏ symbol to switch to the status display.

Entries made before this which have not been confirmed with *OK* will not be saved.

Changing a value or setting

Changing values or settings during a cooking programme

Depending on the function, as soon as a cooking programme is in progress, you can change the values or settings for this programme.

- Touch the function, temperature or current Gourmet units in the middle of the touch display or touch *Change*.

The settings for the cooking programme will appear.

- Change the desired value or setting.

The value or setting is now saved.

Changing a setting in a list

The current setting is highlighted in orange.

- Touch the desired setting.

The setting is now saved. This will take you back to the previous menu.

Entering numbers with the roller

- Swipe the roller up or down until the value you want is displayed in the centre.

- Confirm with *OK*.

The changed number is now saved.

Entering numbers using the numerical keypad

- Touch  in the bottom right of the input field.

The numerical keypad will appear.

- Touch the desired numbers.

As soon as you enter a valid value, *OK* turns green.

Use the arrow key if you need to delete the last entered number.

- Confirm with *OK*.

The changed number is now saved.

Changing the setting with a segment bar

Some settings are represented by a bar  with seven segments. If all of the segments are illuminated, the maximum value is selected.

If none of the segments are illuminated or if only one is, the minimum value is selected or the setting is switched off altogether (e.g. buzzers).

- Touch the corresponding segment on the segment bar to change the setting.
- Select *On* or *Off* to switch the setting on or off.
- Confirm your selection with *OK*.

The setting is now saved. This will take you back to the previous menu.

Entering letters

Letters are entered using a display keyboard. It is best to select short, memorable names.

- Touch the desired letters or characters.

Tip: You can add a line break for longer programme names using the  symbol.

- Touch *Save*.

The name is now saved.

Displaying Help

Context-sensitive help is available for certain functions. In this case, *Help* appears in the bottom line.

- Touch *Help* to display information in text and pictures.
- Touch *Close* to return to the previous menu.

Features

Data plate

The data plate is located on the front frame, visible when the door is open.

The data plate states the model number, the serial number as well as connection data (voltage, frequency and maximum rated load).

Please have this information to hand, should you need to contact Miele regarding any questions or problems.

Scope of delivery

- Operating and installation instructions for using the Dialog oven functions
- A cookbook with recipes for the automatic programmes and other functions
- Baking tray, universal tray and wire rack
- Food probe
- Screws for securing your Dialog oven in the housing unit
- Descaling tablets and a plastic tube with suction cup for descaling the steam injection system

Accessories supplied and available to order

All the accessories listed as well as the cleaning and care products are designed for the Miele Dialog oven.

These are available to order via the Miele Webshop, the Miele Customer Service Department or from your Miele dealer.

When ordering, please quote the model number of your Dialog oven and the reference number of the accessories required.

Side runners

There are side runners on the left and right of the oven compartment with shelves  for inserting accessories.

The side runners are suitable for pyrolytic cleaning and are fixed to the sides of the oven compartment.

Each level consists of 2 rails, one above the other. The accessories (e.g. the wire rack) are pushed into the oven between the two rails.

Baking tray, universal tray and rack with non-tip notches

Baking tray HBB 51:

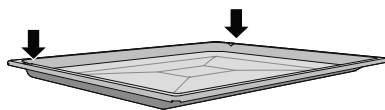

Universal tray HUBB 51:

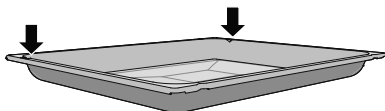

Rack HBBR 52:

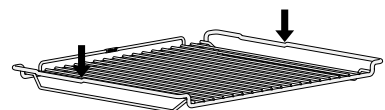

These accessories are inserted into the oven between the two rails of a side runner.

Always position the rack with the non-tip notches at the back.

These accessories have non-tip safety notches towards the back of their short sides. The non-tip safety notches prevent the trays from being pulled out completely when you only wish to pull them out partially.



If you are using the universal tray with the rack on top, insert the tray between the rails of the side runners and the rack will automatically slide in above them.

The surfaces of the baking tray and the universal tray are treated with a PerfectClean enamel.

The rack is suitable for Pyrolytic cleaning.

Grilling and roasting insert HGBB 51

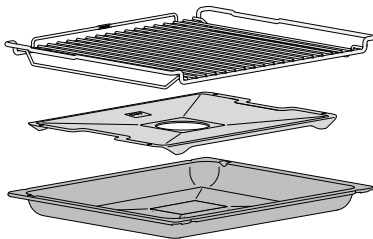

The grilling and roasting insert fits between the rack and the universal tray. The juices from the food being grilled or roasted collect under the insert. This prevents them from spitting and making the oven dirty. The juices can then be used for making gravy and sauces.

The enamelled surface has been treated with PerfectClean.

The grilling and roasting insert is not suitable for use with M Chef functions.

It must only be used with conventional cooking functions.

Round baking trays



The **solid round baking tray HBF 27-1** is suitable for cooking pizzas, flat cakes made with yeast or whisked mixtures, sweet and savoury tarts, baked desserts, flat bread, and can also be used for frozen cakes and pizzas.

The **perforated round baking tray HBFP 27-1** has been specially developed for baked goods made from fresh yeast and quark dough and for baking bread and rolls. The tiny perforations assist in browning the underside of baked goods. The tray can also be used for dehydrating or drying food.

The enamelled surface of both baking trays has been treated with PerfectClean.

- Insert the rack and place the round baking tray on the rack.

The round perforated baking tray is not suitable for use with M Chef functions.

It must only be used with conventional cooking functions.

Features

Baking stone HBS 70



The baking stone is ideal for items which need a well baked base such as pizza, quiche, bread, bread rolls and savoury snacks.

The baking stone is made from heat-retaining fireclay and is glazed. A paddle made of untreated wood is supplied with the baking stone for placing food on it and taking it off.

- Slide the rack in and place the baking stone on it.

The baking stone is not suitable for use with M Chef functions. It must only be used with conventional cooking functions.

Food probe

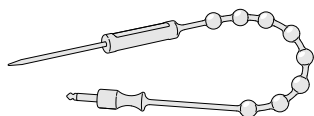

Using the food probe enables the temperature during the cooking programme to be monitored very precisely (see "Roasting - Food probe").

Handle HEG

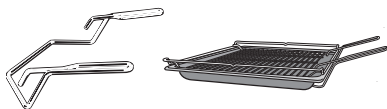

The handle makes it easier to take the universal tray, baking tray and rack out of the oven.

Gourmet oven dishes HUB 62-22 Oven dish lids HBD 60-22

Unlike other oven dishes, the Miele Gourmet oven dishes can be placed in the oven directly on the side runners. They have non-tip safety notches just like the wire rack. This Gourmet dish is also suitable for use on an induction hob.

The surface of the oven dish has a non-stick coating.

A matching metal lid is available to order separately. Please quote the model number when ordering.

With M Chef functions, metal lids reflect electro-magnetic waves and hence prevent cooking. Miele oven dishes with metal lids must only be used with conventional cooking functions. The Miele oven dish must only be used without the lid with M Chef functions.

Depth: 22 cm

HUB 62-22

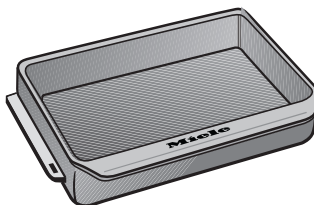

HBD 60-22*

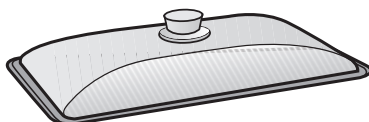

* Only suitable for use with conventional cooking functions

Accessories for cleaning and care

- Descaling tablets, plastic tube with suction cup for descaling the Dialog oven
- Miele all-purpose microfibre cloth
- Miele oven cleaner

Safety features

- **System lock** 
(see “Settings – Safety”)
- **Sensor lock**
(see “Settings – Safety”)
- **Cooling fan**
(see “Settings – Cooling fan run-on”)
- **Safety switch-off**
The safety switch-off is activated automatically if the Dialog oven has been operating for an unusually long period of time. The period of time will depend on the particular oven function being used.
- **Door**
The door seals prevent electromagnetic waves leaking. When the oven is operating, air is passed through the door to keep the outer pane cool.
- **Door locking** for pyrolytic cleaning
At the beginning of a pyrolytic cleaning programme the door will lock for safety reasons. The door will only be unlocked when the temperature in the oven compartment has dropped to below 280 °C.

PerfectClean treated surfaces

PerfectClean surfaces have very good non-stick properties and are exceptionally easy to clean.

Food can be easily removed from these surfaces. Soiling from baking and roasting can be easily removed from these surfaces.

Food can be sliced or cut up on PerfectClean surfaces.

However, do not use ceramic knives as these will scratch the PerfectClean surface.

Surfaces treated with PerfectClean enamel can be cleaned as you would clean glass.

Read the instructions in “Cleaning and care” so that the benefits of the non-stick properties and easy cleaning are retained.

PerfectClean treated surfaces:

- Universal tray
- Baking tray
- Grilling and roasting insert
- Round perforated baking tray
- Round baking tray

Pyrolytic accessories

The side runners are suitable for pyrolytic cleaning and are fixed to the sides of the oven compartment. The rack HBBR 52 is suitable for pyrolytic cleaning and can be left in the oven compartment during pyrolytic cleaning.

See “Cleaning and care” for more information.

Before using for the first time

Miele@home

Your Dialog oven is equipped with an integrated WiFi module.

To use this feature, you will need:

- A WiFi network
- The Miele app
- A Miele user account. The user account can be created via the Miele app.

The Miele app will guide you as you connect your Dialog oven to your home WiFi network.

Once your Dialog oven is connected to your WiFi network, you can use the app, for example, to carry out the following activities:

- Call up information on the operating status of your Dialog oven
- Retrieve information on Dialog oven cooking programmes that are in progress
- Stop cooking programmes that are in progress

Connecting your Dialog oven to your WiFi network will increase energy consumption, even when the Dialog oven is switched off.

Make sure that the signal of your WiFi network is sufficiently strong in the place where you want to install your Dialog oven.

Availability of the WiFi connection

The WiFi connection shares a frequency range with other appliances (including microwave ovens and remote control toys). This can give rise to sporadic or even complete connection failures. Therefore, the availability of featured functions cannot be guaranteed.

Miele@home availability

The ability to use the Miele app depends on the availability of the Miele@home service in your country.

The Miele@home service is not available in every country.

For information about availability, please visit www.miele.com.

Miele App

The Miele App is available to download free of charge from the Apple App Store® or from the Google Play Store™.



See “Settings – Miele@home” for information on setting up Miele@home.

Before using for the first time

Basic settings

The following settings must be made before starting up for the first time. You can change these settings again at a later time (see “Settings”).

 Risk of injury caused by hot surfaces.

The Dialog oven gets hot when it is being used.

For safety reasons, the Dialog oven may only be used when it has been fully installed.

The Dialog oven will switch on automatically when it is connected to the electricity supply.

Setting the language

- Select the desired language.

If you have selected the wrong language by mistake, proceed as described in “Settings –  Language”.

Setting the location

- Select the required location.

Setting the date

- Set the day, then the month, and finally the year.
- Confirm with *OK*.

Setting the time

- Set the time of day in hours and minutes.
- Confirm with *OK*.

Completing the commissioning process

- Follow any further instructions in the display.

The oven is now ready for use.

Before using for the first time



Heating up the Dialog oven for the first time and rinsing the steam injection system

When the Dialog oven is heated up for the first time it may give off a slight smell. This can be eliminated by heating the empty Dialog oven for at least an hour. It is a good idea to rinse out the steam injection system at the same time.

It is important to ensure that the kitchen is well ventilated during the heating process. Prevent the odour from escaping into other rooms.

- Remove any protective wrapping and stickers from the Dialog oven and any accessories.
- Before heating the oven compartment up, wipe the interior with a damp cloth to remove any dust or bits of packaging.
- Insert all trays and the wire rack.
- Switch the Dialog oven on with the On/Off  sensor control.

The main menu will appear.

- Select Oven functions .
- Select Moisture plus .

The recommended temperature will appear (160 °C).

The oven heating and cooling fan will switch on.

- Set the maximum possible temperature (250 °C).
- Confirm with OK.

- Select Automatic burst of steam.

The prompt to draw in water then appears.

- Fill a suitable container with the required amount of mains water.
- Open the door.
- Pull the water intake pipe forwards (located below the control panel on the left).

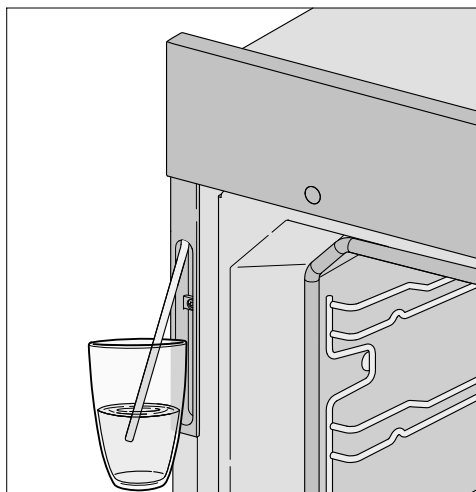

- Immerse the end of the water intake pipe in the container with the mains water.
- Confirm with OK.

The water intake process will begin.

The amount of water actually drawn up into the oven may be less than the amount specified as required, leaving a small amount in the container.

Before using for the first time

- Remove the water container after the water intake process and close the door.

The message confirming that the intake process is completed will disappear.

The sound of the pump running can be heard again briefly. Residual water in the water intake pipe is being drawn into the oven.

After a short time, a burst of steam will be released automatically.

 Risk of injury caused by steam. The steam escaping is very hot. Do not open the door when the burst of steam is being released.

Heat the Dialog oven up for at least an hour.

- After at least an hour, switch the Dialog oven off with the  On/Off sensor control.

Cleaning the oven compartment after heating it up for the first time

 Risk of injury caused by hot surfaces.

The Dialog oven gets hot when it is being used. You could burn yourself on the heater elements, oven compartment or accessories.





Allow the heater elements, oven compartment and accessories to cool before manual cleaning.

- Take all accessories out of the oven compartment and clean it by hand (see “Cleaning and care”).
- Clean the oven compartment with a clean sponge and a solution of hot water and washing-up liquid or a clean, damp microfibre cloth.
- Dry all surfaces with a soft cloth.



Leave the oven door open until the oven compartment is completely dry.

Settings

Settings overview

Menu option	Available settings
Select language 	... deutsch english ... Location
Time	Clock type Analogue* Digital Clock format 24 h* 12 h (am/pm) Set Synchronise Permitted* Not permitted
Date	
QuickTouch	On with time Off*
Start screen	Main menu* M Chef Oven functions Automatic programmes Special applications MyMiele User programmes
Brightness	Display  M Chef 
Colour scheme	Bright Dark*
Volume	Buzzer tones  Keypad tone  Welcome melody On* Off
Units	Weight g* lb lb/oz Temperature °C* °F

* Factory default setting

Menu option	Available settings
Cooling fan run-on	Time controlled Temperature controlled*
Pyrolytic	With reminder Without reminder*
Recommended temperatures	
Safety	System lock  On Off* Sensor lock On Off*
Catalyser	
Network	On Off*
Miele@home	Module settings Module status Start module activity IP settings DNS settings SSID settings Network encryption System settings Change appliance name Appliance list Update appliance list Sign on more appliances Sign out of system Set as timekeeper WPS push button
Remote control	On Off*
SuperVision	SuperVision display On Off* Display in standby On* Only if there is a fault Appliance options Display this appliance Buzzer tones
Showroom programme	Demo mode On Off* M Chef 
Factory default	Settings User programmes Recommended temperatures MyMiele

* Factory default setting

Settings

Opening the “Settings” menu

In the  Settings menu, you can personalise your Dialog oven by adapting the factory default settings to suit your requirements.

You are in the main menu.

- Select  Settings.
- Select the desired setting.



You can check settings or change them.

Settings cannot be changed while a cooking process is in progress.

Language

You can set your language and location.

After selecting and confirming your choice, the language you have selected will appear in the display.

Tip: If you have selected the wrong language by mistake, select  in the main menu. Follow the  symbol to get back to the **Select language ** sub-menu.

Time

Clock type

The time of day can be displayed as Analogue (with a clock face) or Digital (h:min) format.

With the digital display, the date is also shown.

Clock format

The time of day can be displayed in the 24- or 12-hour format (24 h or 12 h (am/pm)).

Set

Set the hours and the minutes.

If there is a power cut, the current time of day will reappear once power has been restored. The time of day is saved for approx. 200 hours.

Synchronise

If the Dialog oven has been connected to a WiFi network and signed in to the Miele app and you select **Permitted**, the time will be synchronised based on the location setting in the Miele app.

Date

Set the date.

When the Dialog oven is switched off, the date will only appear in the display if **Time | Clock type | Digital** has been selected.

QuickTouch

Select how you want the time of day to show in the display when the Dialog oven is switched off:

- On with time
The time of day always shows in the display. All sensor controls react to touch as normal.
- Off
To save energy, the display does not light up. The Dialog oven has to be switched on before it can be used.
- Night dimming
To save energy, the time of day only shows in the display between 05:00 and 23:00. The display appears dark at all other times.

Start screen

The Dialog oven is factory-set for the main menu to appear when it is switched on. You can change this default setting so that, for instance, the oven functions or MyMiele settings appear in the status display straight away (see “MyMiele”).

This new status display will then appear when the Dialog oven is next switched on.

Select the ↩ sensor control or follow the path in the header to get to the main menu.

Brightness

Display

The display brightness is represented by a bar with segments.

- ■■■■■■■■
Maximum brightness
- ■■■■■■■□
Minimum brightness

M Chef

The brightness of the M Chef logo on the control panel is represented by a bar with seven segments.

- ■■■■■■■■
Maximum brightness
- ■■■■■■■□
Minimum brightness

Colour scheme

Choose between a light or dark colour scheme for the display.

- Bright
The display has a light background with dark characters.
- Dark
The display has a dark background with white characters.

Volume

Buzzer tones

If buzzers are switched on, a buzzer will sound when the set temperature is reached and at the end of a set time.

The volume of the buzzers is represented by a bar with seven segments.

- ■■■■■■■■
Maximum volume
- □■■■■■■□
Buzzers are switched off

Keypad tone

The volume of the tone that sounds each time a sensor control is touched is represented by a bar with seven segments.

- ■■■■■■■■
Maximum volume
- □■■■■■■□
Keypad tone is switched off

Welcome melody

The melody that sounds when you touch the ⏻ On/Off sensor control can be switched on or off.

Settings

Units

Weight

For automatic programmes, you can set the weight of food in grams (g), pounds (lb) or pounds/ounces (lb/oz).

Temperature

You can set the temperature in degrees Celsius (°C) or degrees Fahrenheit (°F).

Cooling fan run-on

The cooling fan will continue to run for a while after the oven has been switched off to prevent any humidity building up in the oven compartment, on the control panel or on the oven housing unit.

- Temperature controlled
The cooling fan switches off when the temperature in the oven drops below 70 °C.
- Time controlled
The cooling fan switches off after a period of about 25 minutes.

Condensate can damage the housing unit, damage the worktop and lead to corrosion in the Dialog oven.

If you have set the cooling fan to Time controlled and leave food in the oven compartment to keep warm, moisture levels in the oven will increase, leading to condensation forming on the control panel and furniture front, and drops of moisture collecting under the worktop.

Do not leave food in the oven compartment to keep it warm if you have selected Time controlled.

Pyrolytic

You can set whether the recommendation for carrying out pyrolytic cleaning will appear (With reminder) or will not appear (Without reminder).

Recommended temperatures

If you often cook with different temperatures, it makes sense to change the recommended temperatures.

After selecting this menu option, a list of operating modes will appear in the display.

- Select the relevant operating mode.
The recommended temperatures are displayed along with the available temperature range.
- Change the recommended temperatures.
- Confirm with OK.

Safety

System lock

The system lock prevents the Dialog oven being switched on by mistake.

The alarm and minute minder can still be used when the system lock is active.

The system lock will remain activated even after a mains outage.

- On
The system lock has been activated. If you want to use the Dialog oven, switch it on and touch the  symbol for at least 6 seconds.
- Off
The system lock is deactivated. The Dialog oven can now be used as normal.



Sensor lock

The sensor lock prevents the cooking programme being switched off by mistake or settings being changed. Apart from the ⏻ On/Off sensor control, the activated sensor lock prevents the sensor controls and fields in the display from working for a few seconds after a programme has been started.

- On
The sensor lock is activated. Touch the  symbol for at least 6 seconds to deactivate the sensor lock for a short period of time.
- Off
The sensor lock is deactivated. All sensor controls react to touch as normal.

Catalyser

Odour reduction is represented by a bar with seven segments.

- 
Maximum odour reduction
- 
The catalyser is deactivated

Network

Your Dialog oven can be connected to your local WiFi network via its integrated WiFi module and then controlled using a mobile device (e.g. smartphone or tablet PC).

Make sure that the signal of your WiFi network is sufficiently strong in the place where you want to install your Dialog oven.

- If you want to connect your Dialog oven to your local WiFi network, select Network | On.

Miele@home

Your Dialog oven is a Miele@home-compatible appliance with SuperVision functionality.

Your Dialog oven is fitted ex-works with a WiFi communication module and is suitable for wireless communication.

There are a number of ways of connecting your Dialog oven to your WiFi network. We recommend connecting your Dialog oven to your WiFi network with the help of the Miele app or via WPS.

Module settings

If you would rather set up the connection to your router yourself rather than using the Miele@mobile app or WPS, or if you have a special network configuration, you can enter the relevant settings if you have the necessary technical knowledge.

- Module status
- Start module activity
 - Restart
 - Restart with default settings
 - Restart in Service mode
- IP settings
 - IP set to auto-retrieve
 - IP address
 - Subnet mask
 - Standard gateway
- DNS settings
 - Accept DNS automatically
 - DNS Server 1

Settings

- DNS Server 2
- SSID settings
 - Enter SSID
 - Search SSID
- Network encryption
 - Authentication
 - Network code

Select Network status to show the current module settings.

Start module activity

If you wish to reset all entered settings and values for Miele@home, you can restore the factory default settings on your WiFi module. Any settings that do not affect Miele@home will remain unchanged.

- Select Restart with default settings and confirm with OK.

Please wait will appear in the display.

A few minutes later Restart successful will appear in the display.

- Confirm with OK.

The WiFi module has been reset to its factory default settings.

If the factory default settings were not restored to your WiFi module, repeat the instructions above.

System settings

- Change appliance name
Enter the appliance name using the keyboard. You can add a line break for longer appliance names using the ↵ symbol. The new appliance name will be used by the communication module and by the Miele@mobile app.
- Appliance list
Select this menu option to display signed in household appliances. Follow the instructions on the display.
- Update appliance list
Select this menu option after signing on or signing off further household appliances.
- Sign on more appliances
Select this menu option to sign in additional Miele@home-compatible household appliances. Follow the instructions on the display.
- Sign out of system
Select this menu option to sign the Dialog oven out of the Miele@home system and to deactivate the SuperVision function. Follow the instructions on the display. Sign the Dialog oven out of the Miele@home system if the Dialog oven is being disposed of or sold, or if a used Dialog oven is being put into operation. This is the only way to ensure that all personal data has been removed and the previous owner will no longer be able to access the Dialog oven.
- Set as timekeeper
Select this menu option to synchronise the time of day on all networked appliances.

WPS push button

As an alternative to networking your Dialog oven via the Miele@mobile app, we recommend using WPS (Wireless Protected Setup). To do so, you will need a WPS-compatible router.

- Select WPS push button.

Please wait **will** appear in the display.

- Activate the WPS function on your router within 2 minutes.
- Once the connection has been made, confirm the message with **OK**.

The Dialog oven will then go back to the Miele@home menu.

If the connection fails, you have probably not activated WPS on your router quickly enough. Repeat the steps above.

Remote control

If you have installed the Miele app on your mobile device, have access to the Miele@home system and have activated the remote control function (On), you can retrieve information on Dialog oven cooking programmes that are in progress or end a cooking programme in progress, for instance.

The  symbol will appear in the top right-hand side of the display.

SuperVision

The Dialog oven is a Miele@home-compatible household appliance with SuperVision functionality for monitoring other household appliances in the Miele@home system.

The SuperVision function cannot be activated until the Miele@home system has been set up.

SuperVision display

- On
The SuperVision function is switched on.
The  symbol will appear in the top right-hand side of the display.
- Off
The SuperVision function is switched off. No other SuperVision functions are available.

Display in standby

The SuperVision display function is also available when the oven is in standby. However, the time of day display must be switched on (Settings | QuickTouch | On with time).

- On
Active household appliances that are signed in to the Miele@home system are always displayed.
- Only if there is a fault
Only faults on active household appliances are shown.

Settings

Appliance options

All household appliances signed in to the Miele@home System are displayed. Once you have selected an appliance, you can access further settings:

- Display this appliance
 - On
The SuperVision function for this appliance is switched on.
 - Off
The SuperVision function for this appliance is switched off. The appliance is still signed in to the Miele@home system. Faults are displayed, even if the SuperVision function for the appliance has been switched off.
- Buzzer tones
You can select whether the buzzers are switched on (On) or switched off (Off) for this appliance.

Showroom programme

This function enables the Dialog oven to be demonstrated in showrooms without heating up. This setting is not needed for domestic use.

Demo mode

If you have demo mode activated, Demo mode active. The appliance will not heat up will appear when you switch the Dialog oven on.

- On
Touch *OK* for at least 4 seconds to activate demo mode.
- Off
Touch *OK* for at least 4 seconds to deactivate demo mode. The Dialog oven can now be used as normal.

M Chef

The brightness of the M Chef logo can be adjusted on the Dialog oven (see “Settings - Brightness”).

Factory default

- Settings
Any settings that have been altered will be reset to the factory default settings.
- User programmes
All user programmes will be deleted.
- Recommended temperatures
Any recommended temperatures that have been changed will be reset to the factory default settings.
- MyMiele
All MyMiele entries will be deleted.

Using the  sensor control, you can set a minute minder, e.g. for boiling eggs, or an alarm for a specific time.

Two alarms can be set simultaneously; two minute minder durations or an alarm and a minute minder duration.

Using the Alarm function

The  alarm can be used to specify a particular time for a buzzer to sound.

Setting the alarm

If QuickTouch | Off has been selected, you will need to switch on the Dialog oven before setting the alarm. The alarm time will then appear in the display when the Dialog oven is switched off.

- Select the  sensor control.
- Select New alarm.
- Set the time for the alarm.
- Confirm with *OK*.

When the Dialog oven is switched off,  and the alarm time will appear in the display instead of the time of day.

If you are cooking at the same time or if you are in a different menu,  and the alarm time will appear at the top right-hand side of the display.

At the specified time for the alarm,  will flash in the display next to the time and a buzzer will sound.

- Select the  sensor control or the set alarm time in the display.

The buzzer will stop and the symbols in the display will go out.

Changing an alarm

- Select the alarm in the display or select the  sensor control and the desired alarm.

The set alarm time appears in the display.

- Set the new time for the alarm.
- Confirm with *OK*.

The adjusted alarm time is now saved and will appear in the display.

Deleting an alarm

- Select the alarm in the display or select the  sensor control and the desired alarm.

The set alarm time appears in the display.

- Select *Reset*.
- Confirm with *OK*.

The alarm will be deleted.

Alarm + minute minder

Using the minute minder function

The  minute minder can be used to time other activities in the kitchen, e.g. boiling eggs.

The minute minder can also be used at the same time as a cooking programme for which the cooking duration start and finish times have been set (e.g. as a reminder to stir the food or add seasoning, etc.).

- The maximum minute minder time that can be set is 9 hours, 59 minutes and 59 seconds.

Tip: When using a function that uses moisture, use the timer to remind you to inject steam manually at the desired time.

Setting the minute minder

If QuickTouch | Off has been selected, you will need to switch on the Dialog oven before setting the minute minder. The minute minder can then be seen counting down in the display when the Dialog oven is switched off.

Example: you want to boil some eggs and set a minute minder duration of 6 minutes and 20 seconds.

- Select the  sensor control.
- Select New minute minder time.
- Set the minute minder time you require.
- Confirm with *OK*.

When the Dialog oven is switched off, the minute minder time counts down in the display and  appears instead of the time of day.

If you are cooking at the same time or if you are in a different menu, the minute minder duration and  will appear at the top right-hand side of the display.

At the end of the minute minder duration,  will flash, the time will start counting up and a buzzer will sound.

- Select the  sensor control or the desired minute minder in the display.

The buzzer will stop and the symbols in the display will go out.

Changing the minute minder duration

- Select the minute minder in the display or select the  sensor control and then the desired minute minder duration.

The minute minder duration selected will appear.

- Set a new minute minder duration.
- Confirm with *OK*.

The changed minute minder duration is now saved and will count down in minutes. Minute minder durations of less than 10 minutes will count down in seconds.

Deleting the minute minder duration

- Select the minute minder in the display or select the  sensor control and then the desired minute minder duration.

The minute minder duration selected will appear.

- Select *Reset*.
- Confirm with *OK*.

The minute minder duration is now deleted.

Principle of operation

M Chef technology uses electro-magnetic waves to heat the food.

The Dialog oven combines two different cooking methods:

- M Chef heats the entire body of the food using electromagnetic waves.
- Conventional heating elements are also used to cook the food and brown it.

An antenna in the roof of the oven releases electro-magnetic waves and measures how much energy is absorbed by the food at short intervals. The energy absorption rate depends on the type of food. Cake, for example, absorbs electro-magnetic waves more efficiently than fatty food or frozen food.

Gourmet units

Gourmet units are the units that indicate how much energy the food has absorbed during cooking.

The Dialog oven regularly measures how much energy the food has absorbed and adapts the amount of energy yet to be released accordingly. The number of Gourmet units used depends, for example, on the weight and type of food being cooked.

The M Chef functions use a combination of M Chef technology and conventional heat. There are, therefore, two different procedures for setting a cooking process:

- In addition to the temperature you also have to set the number of Gourmet units. This energy is then directed into the food until the

number set has been used.

The more Gourmet units you set, the more energy the food receives.

- You don't set any Gourmet units, just the temperature. Gourmet units are automatically allocated to the food. This distribution stops if:
 - A maximum value of 2000 Gourmet units has been reached.
 - You interrupt the distribution of Gourmet units by selecting Stop.
 - You end the cooking process.

Intensity

The intensity determines how quickly and evenly the food should absorb the energy in the form of Gourmet units.

- Strong
For most food, e.g. bread, flaky pastry, casseroles, terrines, roast meat and fish. Depending on the food an average of 11 Gourmet units are used per minute, with a maximum of 13 Gourmet units per minute.
- Medium
For heavy cake mixes (e.g. chocolate cake and almond cake), tray bakes, rolls, pizza and meat. Depending on the food an average of 9 Gourmet units are used per minute.
- Gentle
For delicate food, e.g. cheese cake, crème caramel and soufflés. Depending on the food an average of 3 Gourmet units are used per minute.

These settings will vary depending on the food and should only be taken as a guide.

M Chef

Tip: Recipes for M Chef functions and Automatic programmes can be found in the cookbook for your Dialog oven.



Adapting existing recipes to M Chef functions

The M Chef functions offer more settings than with conventional cooking functions.



The conventional settings should be adapted to suit the food if you are using an M Chef function.

Function

The M Chef functions are a combination of M Chef technology and conventional methods of heating.

- Use the M Chef function with the heating type that equates to the conventional heating type for your recipe (e.g. M Chef + Fan plus  instead of Fan plus .

Temperature

- Owing to the short cooking durations with M Chef functions, the temperature should be set 20 °C higher than you would set it for a conventional function (e.g. 200 °C with M Chef + Conventional heat  instead of 180 °C for Conventional heat .

Grilling functions are the exception here, where the temperature is the same.

Gourmet units

- Check the number of Gourmet units used in a comparable recipe in the cookbook for your Dialog oven for guidance.

- With M Chef functions you do not set any Gourmet units, just the temperature.
- Check the food at regular intervals. If the food has been cooked to your liking, take a note of the number of Gourmet units required.

This way you will get a feel for how many Gourmet units are needed for cooking different types of food.

With double the amount of ingredients for fish and seafood you need approx. 1.5 times the number of Gourmet units, and for gratins and vegetables you need approx. 1.25 times the number of Gourmet units. When cooking meat we recommend using the food probe.

Intensity

- For guidance, check the intensity setting used in a comparable recipe in the Dialog oven cookbook and see “How it works” for more information.

Cooking duration



Depending on the type of food being cooked, durations with M Chef functions are shorter than with their corresponding conventional functions.

- Check whether the food is done after about half the time it would take to cook with a conventional function. If necessary, cook it for a little longer.



Shelf level

- In general use Shelf level 2. Position the food centrally on the rack or baking tray. This will ensure even cooking results.

Gourmet Profi and Gourmet assistant

Go to M Chef  in the main menu to find the Gourmet Profi  and Gourmet assistant  menus.

Gourmet Profi

If you want to carry out all settings for a cooking programme yourself, you will find the **M Chef functions** here such as M Chef + Fan plus  or M Chef + Auto roast  (see “Main menu and sub-menus”).

Depending on the type of food, select the relevant function and set the temperature, Gourmet units and intensity yourself (see “Operation”). The duration with an M Chef function will be shorter than with the corresponding conventional function and results will be better.

Tip: It is not essential to set the number of Gourmet units. If you only set the temperature, Gourmet units will be added as soon as the food is placed in the oven. Check the food at regular intervals to get a feel for how many Gourmet units are required.

Gourmet assistant























If you need help choosing the right settings for a cooking programme, this function will help you with a variety of applications from cakes, bread and bread rolls to pizza, meat, fish and seafood as well as bakes and vegetables.

The Dialog oven will recommend the settings to suit the food to ensure optimum results are achieved. The cooking function is predefined and cannot be changed. The recommended values for temperature, Gourmet units, intensity and duration (depending on the application) can be altered. The influence of these settings on cooking results is described under “Operation”.







Most applications follow the recipes in the Dialog oven cookbook. Results may be different if ingredients and quantities differ.

An overview of applications is given at the end of this document under “Gourmet Assistant overview ”.

Main and sub-menus

Menu	Recommended value	Range
M Chef 		
Gourmet Profi 		
M Chef + Fan plus 	180 °C	30–250 °C
M Chef + Conventional heat 	200 °C	30–280 °C
M Chef + Moisture plus 	180 °C	130–250 °C
M Chef + Intensive bake 	190 °C	50–250 °C
M Chef + Auto roast 	180 °C	100–230 °C
M Chef + Full grill 	240 °C	200–300 °C
M Chef + Fan grill 	200 °C	100–260 °C
Gourmet assistant 		
Oven functions 		
Fan plus 	160 °C	30–250 °C
Conventional heat 	180 °C	30–280 °C
Moisture plus 	160 °C	130–250 °C
Intensive bake 	170 °C	50–250 °C
Auto roast 	160 °C	100–230 °C
Bottom heat 	190 °C	100–280 °C
Top heat 	190 °C	100–250 °C
Full grill 	240 °C	200–300 °C
Economy grill 	240 °C	200–300 °C
Fan grill 	200 °C	100–260 °C
Automatic programmes 		

Main and sub-menus

Menu	Recommended value	Range
Special applications 		
Defrost	–	–
Drying	80 °C	50–100 °C
Heat crockery	50 °C	50–80 °C
Prove dough	35 °C	30–50 °C
Low temp. cooking	100 °C	80–120 °C
Sabbath programme		
Conventional heat	180 °C	30–280 °C
Bottom heat	190 °C	100–280 °C
User programmes 		
Settings 		
Maintenance 		
Descalc		
Pyrolytic		
MyMiele  		

Suitable cookware for M Chef functions

In order for electro-magnetic waves to reach the food, they must be able to penetrate the crockery being used. Electro-magnetic waves pass through porcelain, glass, card and plastic, but not metal. With this in mind, be sure not to use crockery with metallic decoration or metal lids. Metal reflects electro-magnetic waves which can create sparks and the waves are not absorbed by the metal.

 Fire hazard due to using unsuitable crockery with M Chef functions.

Unsuitable crockery can suffer damage and cause damage to the Dialog oven.

Make sure that the crockery you use with M Chef functions is suitable.

The type of material crockery is made from will influence cooking results and durations.

Suitable crockery

With M Chef functions, metal lids reflect electro-magnetic waves and hence prevent cooking.

Oven dishes and pots must be used without a lid or with a glass lid with M Chef functions.

You can use the following crockery and material with M Chef functions:

- Metal dishes such as springform tins, baking tins, roasting dishes and pots
- Heat-resistant glass and ceramic glass
- Porcelain
 - Without metallic decoration
Metallic decoration (e.g. gold rims or cobalt blue) can cause sparking.
 - Without hollow knobs and handles
Moisture can gather in the hollow knobs and handles. When the moisture evaporates, pressure can build up and the item can explode.
- Roasting bags and tubes
Please follow the manufacturer's instructions.

 Fire hazard due to metal parts. Metal parts such as metal clips or plastic and paper ties that have wire running through them can heat inflammable materials until they burn. Do not use metal clips or plastic and paper ties containing wire.

Suitable cookware for M Chef functions

- Heat-resistant plastic containers and single-use plastic containers
Special plastic containers are available from retail outlets. To protect the environment, we do not recommend the use of single-use containers.

Plastic must be heat-resistant to a minimum of 150 °C. Otherwise the plastic may melt and fuse with the food.

Only use plastic containers that are heat-resistant (oven-proof).

Do not leave the Dialog oven unattended when reheating or cooking food in disposable containers made of plastic, paper or other inflammable materials.

Unsuitable crockery

Crockery and lids with hollow handles or knobs can collect moisture in the hollow spaces. When the moisture evaporates, pressure can build up and the item can explode. If the hollow recess is sufficiently ventilated, the item can be used.

Do not use crockery with hollow knobs or handles for cooking with the M Chef functions.

You must **not** use the following crockery and material with M Chef functions:

- Aluminium foil
- Cutlery and crockery with metallic decoration (e.g. gold rims, cobalt blue)
- Crockery with hollow handles
- Stoneware

 Risk of injury caused by hot crockery.







Stoneware can get hot.

Do not use stoneware crockery with M Chef operating modes.

- Wooden dishes and clay pots
Water in the material evaporates during the cooking process. This can cause cracks to appear and the material will be damaged.
- Perforated baking tins
- Grilling and roasting insert HGBB 51

Energy saving tips

Cooking programmes

- If possible, use the automatic programmes for cooking food.
 - Remove all accessories from the oven compartment that are not required for cooking.
 - In general, if a range of temperatures is given in a recipe or chart, it is best to select the lower temperature and to check the food after the shortest duration.
 - Preheat the oven only if instructed to do so in the recipe or the cooking chart.
 - If possible, do not open the door during a cooking programme. If the door is opened during a cooking programme, the heat in the oven automatically switches off. The fan continues to operate. As soon as the door is closed again, the cooking programme will continue. If the door is opened during an M Chef programme, the supply of Gourmet units is interrupted until the door is closed again.
 - Use dark, matt baking tins and cooking containers made of non-reflective materials (enamelled steel, heat-resistant glass, coated aluminium). Shiny materials such as stainless steel or aluminium reflect the heat and therefore can give a more uneven result. Do not cover the oven floor or the wire rack with heat-reflecting aluminium foil.
- It is best to use metal baking tins if possible. Bakeware made from silicone, glass or ceramic may prevent the underside browning sufficiently.
 - Monitor cooking durations to avoid wasting energy when cooking. Set the cooking duration or use a food probe.
 - Most food can be cooked using the M Chef + Fan plus  or Fan plus  functions. Since the fan distributes the heat in the oven compartment straight away, it allows you to use a lower temperature than you would with M Chef + Conventional heat  or Conventional heat . The Fan plus  function also enables you to cook on multiple shelf levels at the same time.
 - M Chef + Fan grill  and Fan grill  are the best functions for grilled dishes. With these functions, you can use lower temperatures than in other grill functions which use the maximum temperature setting.
 - Foods which you are unable to cook at the same time should, if possible, be cooked one after the other in order to make use of existing heat in the oven.

Residual heat utilisation

- In cooking programmes using temperatures greater than 140 °C and with cooking durations longer than 30 minutes, the temperature can be turned down to the lowest possible level about 5 minutes before the end of the cooking programme. The residual heat in the oven is sufficient for cooking the food until it is done. Do not switch the Dialog oven off (see “Warning and safety instructions”).
- If you have set a cooking duration for a cooking programme, the oven heating elements will switch off automatically shortly before the end of cooking. The residual heat in the oven is sufficient to complete the cooking process.
- It is best to start the pyrolytic cleaning programme immediately after a cooking programme. The residual heat in the oven will help reduce the amount of energy required.

Settings

Select the setting **QuickTouch | Off** for the control elements in order to reduce energy consumption.

Energy-saving mode

The Dialog oven will switch itself off automatically to save energy if a cooking programme is not being run and controls have not been operated. The time of day will appear in the display or the display will remain dark (see “Settings”).

Operation

- Switch the Dialog oven on.

The main menu will appear.

- Select the operating mode you want to use (see “Main menu and sub-menus”).

The operating mode will appear in the display. Depending on the operating mode, the recommended values will appear in the display, including the temperature and the Gourmet Units for M Chef operating modes.

- Change the recommended values for the cooking process if necessary.

It is not essential to set a specific number of Gourmet Units for **M Chef operating modes**.

If the recommended values are used, the food will be cooked and browned by the heater elements from the outside and Gourmet Units will be automatically added to the food. This stops if:

- A maximum value of 2000 Gourmet Units has been reached.
- You interrupt the addition of Gourmet Units by selecting *Stop*.
- You end the cooking process.

Read more about setting the recommended values in “Changing values and settings for a cooking process”.

- Confirm with *OK*.
- If you have selected an operating mode **without** the *Pre-heat* function, place the food in the oven.

- If you have selected an operating mode **with** the *Pre-heat* function, place the food in the oven as soon as *Place food in oven* appears.

- Close the door.

The required and the actual temperature will appear when using **conventional operating modes**.

With **M Chef operating modes**, the required temperature will appear in the display, followed shortly by the addition of Gourmet Units in addition to the conventional heating method. The number of units can be followed in the display.

You will see the temperature increasing with all operating modes. A buzzer will sound when the set temperature is reached for the first time.

- Take the food out of the oven and switch the Dialog oven off at the end of the cooking process.

Changing values and settings for a cooking programme

Depending on the function, as soon as a cooking programme is in progress, you can change the values or settings for this programme.

Depending on the function, you can change the following settings:

- Temperature
- Gourmet Units
- Intensity
- Duration
- Ready at
- Start at
- Core temperature
- Pre-heat
- Rapid heat-up
- Crisp function
- Change type of heating
- Change function

Changing the temperature and core temperature

You can permanently set the recommended temperature to suit your cooking preferences in Settings | Recommended temperatures.

The  core temperature only appears if you are using the food probe (see “Roasting – Food probe”).

- Select Change.
- Change the temperature and the core temperature if necessary.
- Confirm with OK.

The cooking programme will resume with the new desired temperatures.

If the Pre-heat function has been activated and the temperature first set had not been reached before changing the temperature Appliance pre-heating. Do not place food in the oven yet. will appear in the display.

Confirm the message with OK.

Changing the number of Gourmet units

If you want to set a specific number of Gourmet units as well as the temperature when using M Chef functions, this energy will be added to the food until this number of units has been used up.

If you only set the temperature and do not specify a number of Gourmet units, Gourmet units will be automatically added to the food. This stops if:

- A maximum value of 2,000 Gourmet units has been reached.
- You interrupt the addition of Gourmet units by selecting Stop.
- You end the cooking programme.

If you have set a cooking duration, the number of Gourmet units added will appear in the display as soon as the cooking programme has come to an end.

Operation

- To increase the degree of cooking (e.g. to well done instead of medium when roasting):
Increase the number of Gourmet units. This increases the cooking duration.
- If the degree of cooking has almost been reached:
Reduce the number of Gourmet units. This reduces the cooking duration.
- If the degree of cooking has already been reached, but the food has not browned sufficiently:
Interrupt the addition of Gourmet units by selecting **Stop**. The food will then be browned by the heater elements from the outside.

Increasing or reducing the number of Gourmet units

- Select **Change**.
- Change the number of Gourmet units
- Confirm with **OK**.

Gourmet units are added to the food.

Interrupting or stopping the addition of Gourmet units

- Select **Stop**.

The addition of Gourmet units stops and the desired temperature appears in the display.

- To continue adding units, select **Start**.

The Gourmet units will be added to the food and the number of units will appear in the display.

Changing the intensity

The intensity determines how quickly and evenly the food should absorb the energy in the form of Gourmet units.

- **Strong**
For most food, e.g. bread, flaky pastry, casseroles, terrines, roast meat and fish. Depending on the food an average of 11 Gourmet units are used per minute, with a maximum of 13 Gourmet units per minute.
- **Medium**
For heavy cake mixes (e.g. chocolate cake and almond cake), tray bakes, rolls, pizza and whole poultry. Depending on the food an average of 9 Gourmet units are used per minute.
- **Gentle**
For delicate food, e.g. cheese cake, crème caramel and soufflés. Depending on the food an average of 3 Gourmet units are used per minute.

These settings will vary depending on the food and should only be taken as a guide.

- Select **Change**.
- Select **Open** further settings.
- Change the intensity
- Confirm with **OK**.

The cooking programme will continue with the new intensity level.

Setting cooking durations

Cooking results can be impaired if there is a long delay between the food being placed in the oven and the start of cooking. Fresh food can change colour and even deteriorate. When baking, the cake mixture or dough can dry out, and the raising agents can lose their effectiveness. Select as short as possible a time until the cooking programme starts.

You have placed the food in the oven compartment, selected an operating mode and the required settings such as the temperature.

By entering **Duration**, **Ready at** or **Start at**, you can automatically switch the cooking process off or on and off.

You **cannot** combine **Ready at** and **Start at** with the **Pre-heat** function.

- **Duration**
Enter the required cooking duration for the food. At the end of this duration, the oven heating automatically switches off and if you are using M Chef operating modes you can choose whether to add any remaining Gourmet Units to the food or not. The maximum duration that can be set is 12:00 hours.
- **Ready at**
Set the time you want cooking to finish at. When this time is reached, the oven heating automatically switches off and if you are using M Chef operating modes you can choose whether to add any remaining Gourmet Units to the food or not.

- **Start at**
This function will only appear in the menu if you have set a **Duration** or **Ready at time**. With **Start at**, you have to specify when you want the cooking process to start. The oven will start heating up at that time automatically and Gourmet Units will be added to the food if you are using M Chef operating modes.

If the total number of Gourmet Units set have not been used at the end of the cooking duration, **Cooking finished**.

Continue with remaining Gourmet Units? will appear in the display.

If you confirm with **Yes**, the cooking process will continue until all Gourmet Units have been added.

If you select **No**, the cooking process will stop.

If the set number of Gourmet Units has been added, but the duration has not been reached, the oven heating will remain switched on until the duration has been reached. No more Gourmet Units will be added to the food. The heater elements will continue to cook the food and heat and brown it from the outside until the end of the cooking process.

- **Select Change.**
- **Select Open further settings.**
- **Set the desired times.**
- **Confirm with OK.**

Operation

Changing the set cooking durations

- Select **Change**.
- Select **Open further settings**.
- Select the desired time and change it.
- Confirm with **OK**.

These settings will be deleted in the event of a power failure.

Deleting the set cooking durations

- Select **Change**.
- Select **Open further settings**.
- Set the required duration to -- --.
- Confirm with **OK**.

If you delete **Duration**, the set times for **Ready at** and **Start at** are also deleted.

If you delete **Ready at** or **Start at**, the cooking programme will start using the cooking duration set.

Cancelling a cooking programme

- Touch the  sensor control twice.
- When **Cancel cooking?** appears, select **Yes**.

The oven will stop heating up and Gourmet units will no longer be added if you are using M Chef functions. Any cooking durations set will be deleted.







Pre-heating the oven

The **Rapid heat-up** function is used to quickly pre-heat the oven in some conventional cooking functions.

The **Pre-heat** function is used to quickly pre-heat the oven in all functions. If you have set a cooking duration, it will only start to count down when the desired temperature is reached and you have placed the food in the oven.

It is only necessary to pre-heat the oven in a few instances.

Use the **Dialog oven cookbook** for guidance.

- Most dishes can be placed in the cold oven to make use of the heat produced during the heating-up phase.
- Pre-heat the oven when cooking the following food with the following functions:
 - Dark bread dough as well as beef sirloin joints and fillet with the M Chef + Fan plus , M Chef + Moisture plus , M Chef + Conventional heat , Fan plus , Moisture plus  and Conventional heat  functions
 - Cakes and pastries with a short cooking duration (approx. 30 minutes or less) as well as delicate items (e.g. sponge) with the Conventional heat  function (without the **Rapid heat-up** function)

Rapid heat-up

The Rapid heat-up function is used to quickly pre-heat the oven.

The Rapid heat-up function is switched on as the factory default setting for the following functions:

- Fan plus 
- Auto roast 
- Conventional heat 
- Moisture plus 

If you set a temperature above 100 °C and the Rapid heat-up function is switched on, a rapid heating-up phase heats the oven to the set temperature. The top heat/grill element and the ring heating element come on together with the hot air fan.

Delicate items (e.g. sponge or biscuits) will brown too quickly on the top if the Rapid heat-up function is used.

Switch off the Rapid heat-up function for these items.

Switching off Rapid heat-up for a cooking programme

The Rapid heat-up function has to be switched off separately for each cooking programme.

Example: You have selected a conventional cooking function and the required settings such as the temperature.

You want to switch off the Rapid heat-up function for this cooking programme.

- Select Change.
- Select Open further settings.
- Select Pre-heat.

The Rapid heat-up | On field will appear.

- Select Rapid heat-up.

Off will appear in the Rapid heat-up field.

- Confirm with OK.

The Rapid heat-up function is switched off.

Instead of Rapid heat-up, Heating-up phase will appear in the display.

Operation

Pre-heat

The Pre-heat function is generally switched on in all functions, except when you set a cooking programme to switch on and switch off automatically.

In the M Chef functions, Gourmet units are not used during the heating-up phase. As soon as food is placed in the oven, it is heated up and browned by the heater elements from the outside and Gourmet units are added.

If you have set a cooking duration, it will only start to count down when the desired temperature is reached and you have placed the food in the oven.

Start the cooking programme immediately without delaying the start time.

Switching off Pre-heat for a cooking programme

Example: You have selected an M Chef function and the required settings such as the temperature, Gourmet units and intensity.

You want to switch off the Pre-heat function for this cooking programme.

- Place the food in the oven.
- Select Change.
- Select Open further settings.
- Select Pre-heat.

Off will appear in the Pre-heat field.

- Confirm with OK.

The oven heating will switch on and Gourmet units will be added during the heating-up phase. This stops if:

- A maximum value of 2,000 Gourmet units has been reached.
- You interrupt the addition of Gourmet units by selecting Stop.
- You end the cooking programme.

Crisp function

It is a good idea to use the Crisp function function (moisture reduction) when cooking food which has a moist topping e.g. quiche, pizza, tray bakes with fresh fruit toppings or muffins.

Poultry in particular gets a nice crisp skin with this function.

Switching on Crisp function

The Crisp function function can be used with any operating mode and has to be switched on separately for each cooking programme.

Example: You have selected a function and the required settings such as the temperature.

You want to switch on the Crisp function function for this cooking programme.



- Select Change.
- Select Open further settings.
- Select Crisp function.

On will appear in the Crisp function field.

- Confirm with OK.

The Crisp function function is switched on.

Change type of heating

This menu option only appears with the M Chef + Moisture plus  and Moisture plus  functions (see “Functions using moisture – Changing the method of heating”).

Change function



You can change to another function during a cooking programme.

- Select Change.
- Select Open further settings.
- Select Change function.
- Select the new function.

The new function appears in the display with its corresponding recommended values.

- Set the values for the cooking programme and confirm with OK.

Functions using moisture

Your Dialog oven is equipped with a steam injection system for cooking with moisture. Baking, roasting and cooking with the M Chef + Moisture plus  and Moisture plus  functions guarantees optimum steam and air flow for even cooking and browning results.

Depending on the function, set the temperature and Gourmet units (if required) and specify the number of bursts of steam.

After selecting the desired function, set the temperature and the number and type of bursts of steam (Automatic burst of steam, 1 burst of steam, 2 bursts of steam or 3 bursts of steam).

Fresh mains water is taken into the steam injection system via the water intake pipe underneath the control panel on the left.

Liquids, other than water, can cause damage to the Dialog oven.
Only use mains water when cooking with the addition of moisture.

The water is injected as bursts of steam into the oven compartment during the cooking programme. The steam openings are located at the back left corner of the ceiling of the oven.

Suitable food items

One burst of steam takes about 5–8 minutes. The number of bursts of steam and when they are performed will depend on the type of food being cooked:



- **Yeast doughs** will rise better if steam is released at the beginning of the programme.
- **Bread and bread rolls** rise better if steam is released at the start. Another burst of steam at the end of the programme will give the bread and rolls a glistening crust.
- When **roasting meat with a high fat content**, releasing steam at the beginning of roasting will help render the fat.

Additional moisture is not suitable for mixtures which already contain a lot of moisture, such as meringues. These need to dry out during baking.

Tip: Use the Dialog oven cookbook for guidance.

Starting a cooking programme using moisture

It is normal for condensation to form on the inside of the door during steam injection. This will evaporate during the course of the cooking programme.

- Prepare the food and place it in the oven.
- Select the function you want to use (M Chef + Moisture plus  or Moisture plus .

The recommended settings will appear in the display.

- Change the recommended values if necessary.
- Confirm with *OK*.

The selection display for releasing the bursts of steam will then appear.

Selecting the bursts of steam

- **Select** Automatic burst of steam, 1 burst of steam, 2 bursts of steam or 3 bursts of steam.
 - Automatic burst of steam
1 burst of steam will be injected into the Dialog oven automatically after the heating-up phase.
 - Manual
You can release 1, 2 or 3 bursts of steam manually using the touch display.
 - Time controlled
You can set the times for the bursts of steam to be released. The Dialog oven then releases 1, 2 or 3 bursts of steam at the set times.

If you are cooking food, e.g. bread or bread rolls, in a pre-heated oven, it is best to release the bursts of steam manually and switch on the Pre-heat function in the M Chef + Moisture plus  function. The first burst of steam should be released as soon as you have placed the food in the oven.

If you select more than one burst of steam, the second burst of steam cannot be released before the temperature in the oven compartment has reached at least 130 °C.

If you want to use the Pre-heat function with the M Chef + Moisture plus  function, be aware of the heating-up phase when it comes to manual and time-controlled bursts of steam (see “Operation – Pre-heat”).

- If you have selected Time controlled, set the time for each burst of steam.
- Confirm with *OK*.

The prompt to draw in water then appears.

Functions using moisture

Preparing and starting the water intake process

- Fill a suitable container with the required amount of mains water.
- Open the door.
- Pull the water intake pipe forwards (located below the control panel on the left).

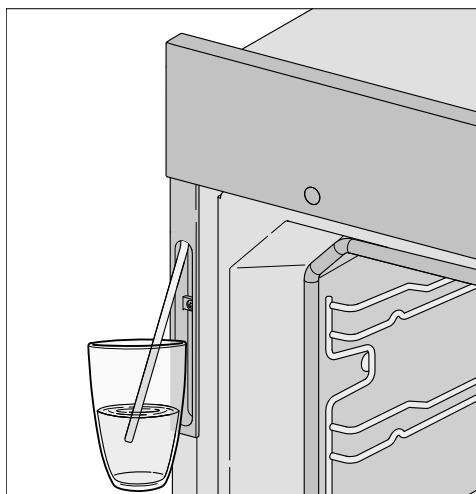

- Immerse the end of the water intake pipe in the container with the mains water.
- Confirm with *OK*.

The water intake process will begin.

The amount of water actually drawn up into the oven may be less than the amount specified as required, leaving a small amount in the container.

You can interrupt and resume the intake process at any time by selecting *Stop* or *Start*.

- Remove the water container after the water intake process and close the door.

The message confirming that the intake process is completed will disappear.

The sound of the pump running can be heard again briefly. Residual water in the water intake pipe is being drawn into the oven.

The oven heating and cooling fan will switch on. The required and the actual temperature will appear.

You will see the temperature increasing. A buzzer will sound when the set temperature is reached for the first time.

If you have selected *Time controlled*, you can check the time before steam is released by selecting *Change*.

Change type of heating

The M Chef + Moisture plus  function uses M Chef + Fan plus with the addition of moisture as standard.

The Moisture plus  function uses Fan plus with the addition of moisture as standard.

You can also use moisture with another method of heating instead of Fan plus:

- Conventional heat
- Intensive bake
- Auto roast

- Select Change.
- Select Open further settings.
- Select Change type of heating.
- Select the method of heating you want.
- Confirm with *OK*.

Cooking will be carried out using the method of heating selected.

With the M Chef + Moisture plus  function, Gourmet units are also added to the food.

Releasing bursts of steam

 Danger of injury caused by steam.

Steam can cause severe scalding. In addition, steam condensing on the control panel will cause the sensor controls and the touch display to react more slowly.

Do not open the door whilst steam is being released.

Automatic burst of steam

Once the heating-up phase has been completed, the burst of steam is released automatically.

The water will evaporate in the oven compartment and Burst of steam active will appear in the display.

After the burst of steam, Burst of steam finished will appear in the display.

- Continue cooking the food until the end of the cooking duration.

Manual

You can release the bursts of steam as soon as Start Manual burst of steam appears.

Wait until the heating-up phase is completed to allow the steam to be distributed evenly by the warm air in the oven.

Tip: Refer to the recipes in the cookbook or the Miele app for tips on when to release the bursts of steam. Use the  Minute minder function to remind you of the timing.

Functions using moisture

■ Select Start.

The burst of steam will be released.

Burst of steam active appears.

- Proceed as described to release further bursts of steam as soon as Start Manual burst of steam appears.

After the final burst of steam, Burst of steam finished will appear in the display.

- Continue cooking the food until the end of the cooking duration.

Time controlled

The Dialog oven will release the burst of steam at the specified time.

Burst of steam active appears when the burst of steam is being released.

After the final burst of steam, Burst of steam finished will appear in the display.

- Continue cooking the food until the end of the cooking duration.

Evaporate residual moisture

When cooking using the addition of moisture, the water will be equally distributed between the bursts of steam and used up as long as the programme is not interrupted.

However, if a cooking programme with moisture is manually interrupted before all the bursts of steam have been released or if there is a power cut, the water for these unused bursts of steam will remain in the steam injection system.

The next time M Chef + Moisture plus , Moisture plus  or an automatic programme with moisture is used, Evaporate residual moisture? will appear in the display.

- It is best to start the evaporation of residual water straight away so that only fresh water is used during the next food cooking programme.

 Risk of injury caused by steam. Steam can cause severe scalding. Do not open the door whilst bursts of steam are being released.

Depending on the amount of water, evaporation of residual water can take up to 30 minutes.

The oven compartment is heated up and the remaining water is evaporated, causing condensation to form in the oven compartment and on the door.

- Be sure to wipe away the condensation from the door and oven compartment once the compartment has cooled down.

Starting residual water evaporation immediately

 Risk of injury caused by steam. Steam can cause severe scalding. Do not open the door whilst bursts of steam are being released.

- Select a function or an automatic programme that uses moisture.

The prompt *Evaporate residual moisture?* will then appear.

- Select **Yes**.

Evaporate res. moisture and a time then appear in the display.

The residual water evaporation will then start. You can follow the time counting down in the display.

The time shown in the display will depend on the amount of residual water left in the steam injection system. During the evaporation process, the duration may be adjusted by the system according to the amount of water currently present.

At the end of the residual water evaporation process, *Process finished* will appear.

- Select the  sensor control.

A cooking process using an operating mode or an automatic programme with moisture can now be run.

Whilst residual water is evaporating, moisture will condense on the door and in the oven compartment. This moisture needs to be removed after the oven compartment has cooled down.

Skipping residual water evaporation

Allowing further intake of water can, under extremely adverse circumstances, cause water to overflow from the steam injection system into the oven compartment. It is therefore best not to cancel the residual water evaporation process.

- Select a function or an automatic programme that uses moisture.

Evaporate residual moisture? appears.

- Select **Skip**.

A cooking programme using a function or an automatic programme with moisture can now be run.

You will be prompted to carry out the evaporation of residual water again the next time you select a function or an automatic programme with moisture and when you switch the oven off.

Automatic programmes

The wide range of automatic programmes enables you to achieve excellent results with ease.

Most of the automatic programmes use M Chef technology. Settings such as the number of Gourmet units and the intensity are automatically set in these programmes. Recipes for automatic programmes can be found in the cookbook supplied with your Dialog oven.

An overview of applications is given at the end of this document under “Overview of automatic programmes ”.

Using automatic programmes

- Select Automatic programmes .

A list will appear in the display.

- Select the desired category.

The automatic programmes available for the category selected will then appear.

- Select the desired automatic programme.
- Follow the instructions on the display.

Some automatic programmes will prompt you to use the food probe. Read the information under “Roasting – Food probe”.

The core temperatures cannot be changed for the automatic programmes.

Usage notes

- When using automatic programmes, the recipes provided are designed as a guide only. Other similar recipes, including those using different quantities, can be used for the automatic programme in question.
- After cooking, allow the oven compartment to cool down to room temperature again before starting an automatic programme.
- Some automatic programmes require a pre-heating phase before food can be placed in the oven. A prompt will appear in the display indicating when this needs to be done.
- Some automatic programmes require the addition of liquid after a certain cooking duration. You will be prompted by a message in the display when this needs to be done (e.g for adding liquid).
- The duration quoted for automatic programmes is an estimate. It may increase or decrease depending on the programme. The duration, in particular with meat, will vary depending on the initial temperature of the food.
- When using the food probe, the cooking duration will depend on when the core temperature is reached.
- If by the end of an automatic programme the food is not cooked enough for your taste, select **Continue cooking** or **Continue baking**. Conventional heating will then be used for 2 minutes to continue cooking or baking the food.

Search

(Depending on language)

Under Automatic programmes, you can search by the name of the categories and the automatic programmes.

There is a full text search function which can also be used to search for parts of words.

From the main menu:

- Select Automatic programmes .

The category list will appear in the display.

- Select Search.
- Use the keyboard to type in the search text, e.g. "Bread".

The number of hits will be shown in the footer.

If no match is found, or if there are more than 40 matches, the hits field is deactivated and you will need to change the search text.

- Select XX hits.

The categories and automatic programmes found will then appear.

- Select the desired automatic programme, or the category and then the desired automatic programme.

The automatic programme will start.

- Follow the instructions on the display.

Special applications

This section provides information on the following applications:

- Defrost
- Drying
- Heat crockery
- Prove dough
- Low temp. cooking
- Sabbath programme
- Frozen food/ready meals

Defrost

This programme has been developed for gently defrosting frozen food, such as a whole chicken, minced meat, fish or fruit.

Air in the oven compartment is circulated by the fan and the frozen food is gently and rapidly defrosted by electro-magnetic waves.

You simply select the height and weight of the frozen food and the Dialog oven then automatically calculates the number of Gourmet units required.



Danger of bacteria.

Bacteria such as salmonella can cause life-threatening food poisoning.

It is particularly important to observe food hygiene rules when defrosting fish and meat, and in particular when defrosting poultry.

Do not use the liquid produced during defrosting.

Process the food as required as soon as it has been defrosted.

- Measure the height of the frozen food and then weigh it.
- Place the frozen food, unwrapped, in a bowl or dish made from a material that is suitable for use with M Chef functions.
- Place the bowl or the dish on the wire rack.

- Select Special applications .
- Select Defrost.
- Enter the height of the frozen food, and then confirm with *OK*.
- Enter the weight of the frozen food and then confirm with *OK*.
- Follow the instructions on the display.

The food will now be gently defrosted. Depending on the frozen food, an average of 7 Gourmet units are used per minute and the whole process takes 15–45 minutes.

- Turn or stir the food when prompted to do so. Rotate frozen food that is not suitable for turning over.
- Frozen food that weighs more than 1 kg should be turned or stirred several times during defrosting, even if you have not been prompted to do so by a display message. Rotate frozen food that is not suitable for turning over. This will help you to achieve an even result.

Fish and meat do not need to be fully defrosted before cooking. Defrost until the food has started to thaw. The surface will then be sufficiently thawed to absorb herbs and seasoning.

Defrosting a cream filled cake

Frozen cream cakes are a very delicate food that can be quickly and gently defrosted in the Dialog oven.

- Place the frozen cream cake on a serving platter.
- Place the platter on the rack.
- Select Special applications .
- Select Defrost.
- Enter the height of the cream cake, and then confirm with *OK*.

Tip: If the height of the cream cake is in between two settings, select the lower value.

- Enter the weight of the cream cake, and then confirm with *OK*.
- Reduce the number of recommended Gourmet Units to 15–20 % and confirm with *OK*.
- Follow the instructions in the display.

The cream cake will defrost gently. The process takes approx. 30 minutes.

- Turn the cream cake when prompted to do so and then turn it every 8–10 minutes.
- Check that it is defrosting evenly every time to turn it.

Special applications





Drying



Dehydrating or drying is a traditional method of preserving fruit, certain vegetables and herbs.

It is important that fruit and vegetables are ripe and not bruised before they are dried.

- Peel and core the food for drying, if necessary, and cut it up.
- Distribute the food for drying evenly in a single layer according to size over the wire rack or the universal tray.
- Dry on a maximum of 2 levels at the same time.
Place the food for drying on shelf levels 2+3.
If using the wire rack and universal tray, place the universal tray below the wire rack.
- Select Special applications .
- Select Drying.
- Alter the recommended temperature if necessary and then set the duration.
- Follow the instructions on the display.
- Turn the food for drying on the universal tray at regular intervals.

The drying times are longer for whole or halved dried food.

Food for drying		🌡️ [°C]	🕒 [h]
Fruit		60–70	2–8
Vegetables		55–65	4–12
Mushrooms		45–50	5–10
Herbs*		30–35	4–8

 Special application/Operating mode, 🌡️ Temperature, 🕒 Drying time,  Special application Drying,  Operating mode Conventional heat

* Dry herbs only on the universal tray on shelf level 2 and use the Conventional heat  operating mode, as the fan is switched on in the Drying special application.

- Reduce the temperature if condensation begins to form in the oven compartment.

Removing the dried food

 Risk of injury caused by hot surfaces.

The oven gets hot during operation. You could burn yourself on the heating elements, oven compartment or accessories.

Use oven gloves when removing dried food from the oven.

- Allow the dried fruit or vegetables to cool down after drying.

Dried fruit needs to be completely dry, but also soft and elastic. Juice should not escape when cut.

- Store dried food in sealed glass jars or tins.

Heat crockery

If the crockery is pre-heated, the food does not cool down as quickly.

Use heat-resistant crockery.

- Place the wire rack on shelf level 2 and place the crockery to be warmed on it. Depending on the size of the crockery, you can also place the rack on the oven floor.
- Select Special applications .
- Select Heat crockery.
- Alter the recommended temperature if necessary and then set the time.
- Follow the instructions on the display.

 Risk of injury caused by hot surfaces.

The Dialog oven gets hot when it is being used. You could burn yourself on the heater elements, oven compartment or accessories. Droplets of water may have accumulated underneath the crockery.

Use oven gloves when removing the crockery from the oven.

Prove dough

This programme is designed specifically for proving yeast dough **without** the addition of moisture.

If you wish to prove yeast dough **with** the addition of moisture, use the relevant automatic programmes.

- Select Special applications .
- Select Prove dough.
- Alter the recommended temperature if necessary and then set the duration.
- Follow the instructions on the display.

Special applications

Low temp. cooking

The Low temp. cooking cooking method is ideal for cooking beef, pork, veal or lamb when a tender result is desired.

First sear the meat all over at a high temperature on the hob in order to seal it.

Then place the meat in the pre-heated oven compartment where the low temperature and long cooking duration will cook it to perfection and ensure it is very tender.

The meat will relax. The juices inside will start to circulate evenly throughout the meat to reach the outer layers. This gives very tender and succulent results.

- Only use lean meat which has been correctly hung and trimmed. Bones must be removed before cooking.
- For searing, use a suitable cooking oil or fat that can withstand high temperatures (e.g. clarified butter, vegetable oil).
- Do not cover meat during the cooking process.

The cooking duration takes approx. 2–4 hours depending on the weight and size of the meat and how well you want it cooked.

- As soon as the cooking process is done, you can carve the meat straight from the oven. It does not need to rest.
- The meat can be left in the oven compartment to keep warm until you serve it. This will not affect results in any way.

- Serve on pre-heated plates with very hot sauce or gravy to prevent it cooling down too quickly. The meat is at the ideal temperature for eating straight away.

Using the Low temp. cooking special application

Observe the information under “Roasting – Food probe”.

- Select Special applications .
- Select Low temp. cooking.
- Follow the instructions on the display. Place the necessary accessories in the oven compartment for the pre-heating phase.
- Set the temperature and the core temperature.
- Whilst the oven is pre-heating, sear the meat thoroughly on all sides on the hob.

 Danger of burning due to hot surfaces.

The Dialog oven gets hot when it is being used. You could burn yourself on the heater elements, oven compartment or accessories.

Use oven gloves when placing hot food in the appliance or removing it and when working in the hot oven compartment.



- As soon as Place food in oven and use the food probe appears in the display, place the seared meat on the wire rack and insert the metal tip of the food probe fully into the centre of the meat.
- Close the door.

At the end of the programme, Process finished appears in the display and a buzzer sounds.

Using the Conventional heat function

Follow the information in the cooking charts at the end of this book.

Use the universal tray with the wire rack placed on top of it. Switch off the Rapid heat-up function for the pre-heating phase.

- Place the wire rack together with the universal tray on shelf level 2.
- Select Oven functions .
- Select the Conventional heat  function and a temperature of 120 °C.
- Switch off the Rapid heat-up function.
- Pre-heat the oven together with the universal tray and wire rack for approx. 15 minutes.
- Whilst the oven is pre-heating, sear the meat thoroughly on all sides on the hob.

 Danger of burning due to hot surfaces.

The Dialog oven gets hot when it is being used. You could burn yourself on the heater elements, oven compartment or accessories.

Use oven gloves when placing hot food in the appliance or removing it and when working in the hot oven compartment.

- Place the seared meat on the wire rack.
- Select Change.
- Reduce the temperature to 100 °C (see “Cooking charts”).
- Continue cooking the meat until it is done.



Special applications

Sabbath programme

The Sabbath programme is for religious observance.

After you have selected the special application, select the operating mode and temperature.

The programme sequence will only start after the door is opened and closed:

- After approx. 5 minutes, the cooking process will begin using the Conventional heat  or Bottom heat  operating mode.
- The Dialog oven will heat up to the temperature you have set and will maintain this temperature for a maximum of 72 hours.
- The oven interior lighting does not come on, even when the door is opened.
- Sabbath programme appears constantly in the display.
- The time of day does not appear.

Once the Sabbath programme has started, it cannot be changed or saved under User programmes.

Once a Sabbath programme has started, you can only end it prematurely by switching off the Dialog oven.

- Select Special applications .
- Select Sabbath programme.
- Select the operating mode you want to use.

You will not be able to start the special application if you have set a minute minder or alarm.

- Set the temperature.
- Confirm with *OK*.

Sabbath programme  and the set temperature will appear in the display.

- Open the door when you want to start the cooking process.
- Place the food in the oven compartment.
- Close the door.

The oven heating will switch on after 5 minutes.

The Dialog oven will switch off automatically after 72 hours. If you want to end the special application prematurely:

- Switch the Dialog oven off with the On/Off  sensor control.

Frozen food/Ready meals

Tips for cakes, pizza and baguettes

- Bake cakes, pizza and baguettes on baking paper on the rack.
Do not use the baking tray or the universal tray for frozen foods with a large surface area. The tray could become warped and difficult, or even impossible, to remove from the oven compartment when hot. Additional use will make the warping worse.
- Use the lowest temperature recommended on the packaging.

Tips for French fries, croquettes and similar items

- These frozen items can be cooked on the baking tray or universal tray.
Place baking parchment on the tray so that they cook gently.
- Select the Conventional heat  function, switch off the Rapid heat-up function and switch on the Crisp function function.
- Use the highest temperature recommended on the packaging and place the frozen foods in the pre-heated oven.
- Turn the food several times during cooking.

Preparing frozen food/ready meals

Handling food carefully will help protect your health.

Cakes, pizzas and french fries should be cooked until golden, not dark brown.

- Select the function and temperature recommended on the packaging.
- Pre-heat the oven compartment.
- Place the food in the pre-heated oven compartment on the shelf level recommended on the packaging.
- Check the food at the end of the shortest cooking duration recommended on the packaging.

User programmes

You can save up to 20 User programmes:

- At the end of an Automatic programme, save it as a User programme.
- Save a cooking programme that has settings such as function, temperature, Gourmet units, intensity and duration or core temperature once it has finished.
- You can use the Miele@mobile App to transmit programme settings for selected recipes to your Dialog oven and then start the programme. These settings are not saved.

If you wish to save the programme, you have to give it a name. When you call up and start your programme again, it will run automatically.

Saving a user programme

When a cooking programme that had the cooking duration or Gourmet units set or an automatic programme has finished, **Process finished** and **Save** will appear in the display.

- Select **Save** to save the last settings as a user programme.

A summary of your settings will appear in the display.

- Check the settings and confirm with **Accept**.
- Enter the programme name using the keyboard.

You can add a line break for longer programme names using the **↵** symbol.

Select the **↔** sensor control if you do not want to save the settings.

- Once you have entered the programme name, select **Save**.
- Confirm the message informing you that your programme name has been saved with **OK**.

Starting user programmes

- Place the food in the oven.
- Select User programmes .
- Select the programme you want to use.

You can start the programme immediately or delay the start.

- Start now
The programme will start immediately. The oven heating will switch on immediately.
 - Start later
This menu option only appears when you are using the food probe. Specify the time you want cooking to start. The oven heating will switch on automatically at the time you have set.
 - Ready at
Specify the time you want cooking to stop. The oven heating will switch off automatically at the time you have set.
 - Start at
Specify the time you want cooking to start. The oven heating will switch on automatically at the time you have set.
 - Display cooking stages
A summary of your settings will appear in the display.
- Select the menu option you want.

The programme selected will begin straight away or at the time set.

Deleting user programmes

- Select User programmes .

The programme names appear in the display.

- Select Process.
- Select Delete programme.
- Select the programme you want to use.
- Confirm with OK.

The programme will be deleted.

Go to Settings | Factory default | User programmes to delete all user programmes at the same time.

MyMiele

Under MyMiele , you can save frequently used applications.

It is particularly useful with automatic programmes as you do not need to work through every menu level in order to start your programme.

Tip: You can also set menu options that you have entered in MyMiele as your start screen (see “Settings – Start screen”).

Add entry

You can add up to 20 entries.

- Select MyMiele .
- Select Add entry.

You can select sub-menus from the following:

- M Chef 
- Oven functions 
- Automatic programmes 
- Special applications 
- User programmes 

- Confirm with OK.

The selected sub-option with its symbol appears in the list.

- Proceed as described for further entries. Only sub-options which have not yet been added are available for selection.

The position of the MyMiele  menu will change in the main menu.

Editing MyMiele

After selecting Process, you can add entries (up to a maximum of 20), sort entries (if there are more than 4) or delete entries.

Deleting entries

- Select MyMiele .
- Select Process.
- Select Delete entry.
- Select the entry that you want to delete.
- Confirm with OK.

The entry will then be removed from the list.

You can delete all MyMiele entries at the same time with Settings | Factory default | MyMiele.

Sorting entries

The order can be rearranged as long as there are more than 4 entries.

- Select MyMiele .
- Select Process.
- Select Sort entry.
- Select the entry.
- Select the position you want to move it to.
- Confirm with OK.

The entry will now appear in the position you want it in.

Handling food carefully will help protect your health.

Cakes, pizzas and french fries should be cooked until golden, not dark brown.

Tips on baking

- If you are using M Chef functions, the food is cooked from the inside by electro-magnetic waves and at the same time browned on the outside by the heater elements. Cooking durations are shorter this way than with conventional functions. The set temperature is higher in order to achieve the level of browning required in the shorter time.
- Set a cooking duration. When baking, do not delay the start for too long. Otherwise the cake mixture or dough will dry out and the raising agents will lose their effectiveness.
- Generally speaking, you can use wire racks, baking trays, universal trays and any type of bakeware made of heat-resistant material.
- The bakeware used depends on the oven function and how the food is cooked. It is best to use metal baking tins if possible. Bakeware made from silicone, glass or ceramic may prevent the underside browning sufficiently.
- Avoid using bright, thin-walled tins made from a shiny material as they give an uneven or poor browning result. In certain unfavourable conditions, the food will not bake properly.

- Position rectangular tins with the longer side across the width of the oven compartment for optimum heat distribution and even baking results.
- Always place bakeware on the wire rack.
- Bake cakes with fruit toppings or deep cakes on the universal tray.

Using baking parchment

Miele accessories, e.g. the universal tray, are treated with PerfectClean enamel (see "Features"). Surfaces treated with PerfectClean enamel generally do not need to be greased or covered with baking parchment.

- Use baking parchment when baking lye mixtures because the sodium hydroxide used can damage the surface treated with PerfectClean.
- Use baking parchment when baking sponge, meringue, macaroons or similar items. Due to their high egg white content, these are more likely to stick.
- Use baking paper when cooking frozen food on the rack.

Baking

Notes on the cooking charts

You can find the cooking charts at the end of this book.

Selecting the temperature

- As a general rule, select the lower temperature given in the chart. Baking at temperatures higher than those recommended may reduce the cooking duration, but will lead to uneven browning of the food and unsatisfactory cooking results.

If you are using M Chef functions, the food is cooked from the inside by electro-magnetic waves and at the same time browned on the outside by the heater elements. Cooking durations are shorter this way than with conventional functions. The set temperature is higher in order to achieve the level of browning required in the shorter time.

Selecting the cooking duration

Unless otherwise stated, the cooking durations given in the cooking charts are for an oven compartment which has not been pre-heated. With a pre-heated oven compartment, shorten times by around 10 minutes.

- As a general rule, check the food after the shortest duration. Stick a wooden skewer into the food.

If it comes out clean without any batter/dough on it, the food is done.

Notes on the functions

You can find an overview of all the functions with their recommended values in “Main and sub-menus”.

Using Automatic programmes

- Follow the instructions on the display.

Use the Dialog oven cookbook for guidance.

Using M Chef + Fan plus

Use this function for baking cakes and bread.

- Place the food on shelf level 2.

Using Fan plus

Since the fan distributes the heat around the oven compartment straight away, it allows you to use a lower temperature than you would with the Conventional heat  function.

Use this function for baking biscuits and cookies.

Use this function if you are baking on multiple shelves at the same time.

- 1 shelf level: place flat items (e.g. biscuits) on shelf level 1.
- 1 shelf level: place tray cakes and cakes in baking tins on shelf level 2.
- 2 shelf levels: place the food on shelf levels 2+3.

Tips

- If you are cooking on multiple shelves at the same time, slide the universal tray in on the lowest level.
- For moist biscuits and cakes, bake on a maximum of 2 shelf levels at once.

Using M Chef + Moisture plus and Moisture plus



Use these functions for cooking with moisture.

- Place the food on shelf level 2.

Using M Chef + Intensive bake and Intensive bake

Use these functions for baking cakes with moist toppings.

Do **not** use these functions for baking thin biscuits.

- M Chef + Intensive bake : Place the food on shelf level 2.
- Intensive bake : Place the food on shelf level 1.

Using M Chef + Conventional heat and Conventional heat

Dark metal, enamel, or aluminium baking tins with a matt finish, as well as heat-resistant glass, ceramic, and coated bakeware can be used.

Use these functions for baking traditional recipes. If using an older recipe or cookbook, set the oven temperature 10 °C lower than the recommended one. The cooking duration is shortened when you use the M Chef + Conventional heat  function.

- Place the food on shelf level 2.

Roasting

Tips for roasting

- You can use all crockery made from temperature-resistant materials, e.g. roasting dishes and pots (metal lids can only be used with conventional cooking functions), ovenproof glass dishes, roasting bags and tubes, universal trays, wire racks on top of universal trays.
You should only use a grilling and roasting insert (if you have one) on the universal tray and a clay pot with conventional cooking functions.
- **Pre-heating** the oven is only required when roasting beef sirloin joints and fillet. Pre-heating is generally not necessary.
- Use a **roasting dish** for roasting meat. The oven compartment will also stay cleaner than when roasting on the wire rack. This ensures that sufficient stock remains for making gravy.
- If you are using a **roasting bag or tube**, follow the instructions on the packaging.
- If you are using the **wire rack** or an **open roasting dish** for roasting, you can add a little fat or oil to very lean meat or place a few strips of streaky bacon on the top.
- **Season** the meat and place in the roasting dish. Dot with butter or brush with oil or cooking fat. For large lean cuts of meat (2–3 kg) and fatty poultry, add about 1/8 litre of water to the dish.

- Do not add too much liquid during cooking as this will hinder the **browning** process. Browning only occurs towards the end of the cooking duration. Remove the lid about halfway through the cooking duration if a more intensive browning result is desired.
- At the end of the programme, take the food out of the oven, cover it and leave to **stand** for about 10 minutes. This helps retain juices when the meat is carved.
- For a crisp finish, baste **poultry** 10 minutes before the end of the cooking duration with slightly salted water.

Notes on the cooking charts

You can find the cooking charts at the end of this book.

- Take note of the temperature range, the shelf levels and the timings. These also take the type of cooking container, the size of the meat and cooking practices into account.

Selecting the temperature

If you are using M Chef functions, the food is cooked from the inside by electro-magnetic waves and at the same time browned on the outside by the heater elements. Cooking durations are shorter this way than with conventional functions. The set temperature is higher in order to achieve the level of browning required in the shorter time.

- As a general rule, select the lower temperature given in the chart. If higher temperatures are used than those specified, the meat will brown on the outside, but will not be properly cooked through.
- When roasting on the wire rack, set a temperature approx. 10 °C lower than for roasting in a roasting dish.

Selecting the cooking duration

Unless otherwise stated, the durations given in the cooking chart are for an oven which has not been pre-heated.

- The traditional British method for calculating the roasting time is to allow 15 to 20 minutes per lb/450 grams, according to type of meat, plus approx. 20 minutes, adjusting the length of time as roasting proceeds to obtain the required result. The roasting time can also be determined by multiplying the thickness of the roast [cm] with the time per cm [min/cm], depending on the type of meat:
 - Beef/venison: 15–18 min/cm
 - Pork/veal/lamb: 12–15 min/cm
 - Sirloin/fillet: 8–10 min/cm
- As a general rule, check whether the food is cooked after the shortest duration.

Cooking durations with M Chef functions are shorter than with conventional cooking functions.

Use the Dialog oven cookbook for guidance.



Tips

- For frozen meat, increase the cooking duration by approx. 20 minutes per kg.
- Frozen meat weighing less than approx. 1.5 kg does not need to be defrosted before roasting.

Notes on the functions

You can find an overview of all the functions with their recommended values in “Main and sub-menus”.

Use the Bottom heat  function towards the end of the cooking duration to brown the base of the food.

Do not use the M Chef + Intensive bake  and Intensive bake  functions for roasting as the juices will become too dark.



Using Automatic programmes

- Follow the instructions on the display.

Use the Dialog oven cookbook for guidance.

Using M Chef + Fan plus and Fan plus

Use these functions for roasting meat, fish and poultry that needs to be well browned as well as sirloin joints and fillet.

Since the fan distributes the heat around the oven compartment straight away when using the Fan plus  function, it allows you to use a lower temperature than you would with the Conventional heat  function.

- Place the food on shelf level 1.

Roasting

Using M Chef + Auto roast and Auto roast

Use these functions for roasting meat, fish and poultry that needs to be well browned as well as sirloin joints and fillet.

The oven heats initially to a high searing temperature (approx. 230 °C) during the searing phase. As soon as this temperature has been reached, the oven automatically drops the temperature back down to the pre-selected cooking temperature (continued roasting temperature).

- Place the food on shelf level 1.

Using M Chef + Moisture plus and Moisture plus

Use these functions for cooking with moisture.

- Place the food on shelf level 1.

Using M Chef + Conventional heat and Conventional heat

Use this function for baking traditional recipes. If using an older recipe or cookbook, set the oven temperature 10 °C lower than the recommended one. This will not change the cooking duration.

- Place the food on shelf level 1.

Food probe

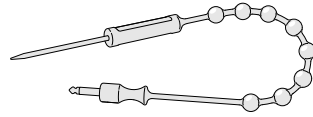

The food probe enables precise temperature controlled roasting.

How it works

The metal tip of the food probe must be fully inserted into the centre of the food all the way to the handle. There is a temperature sensor in the metal tip which measures the core temperature of the food during cooking. The rise in the core temperature of the food reflects the progress of cooking. Set a lower or higher core temperature, depending on whether you want your roast to be medium or well done.

The core temperature can be set up to 99 °C. Information on food and respective core temperatures can be found in the cooking charts at the end of this book.

The cooking duration will be similar when cooking with or without the food probe.

Important usage notes

- You can place the meat in a pot or on the rack.
- The metal tip of the food probe must be fully inserted into the centre of the food so that the temperature sensor reaches more or less to the core.
- When cooking poultry, insert the metal tip into the thickest part of the breast. Press the breast with your index finger and thumb to find the thickest part.
- The metal tip must not touch any bone or be inserted in areas with a lot of fat. Heavily marbled areas and bones can cause cooking to end prematurely.
- If the meat is very heavily marbled with fat, select the highest core temperature given in the cooking charts.
- When using aluminium foil or roasting bags, insert the food probe through the foil/bag into the centre of the food. You can also place meat inside the bag or foil with the food probe already inserted. Follow the roasting bag manufacturer's instructions.

Using the food probe

- Insert the metal tip of the food probe completely into the centre of the food all the way to the handle.

If you are cooking several pieces of meat at the same time, insert the food probe into the largest piece of meat.

- Place the food in the oven compartment.

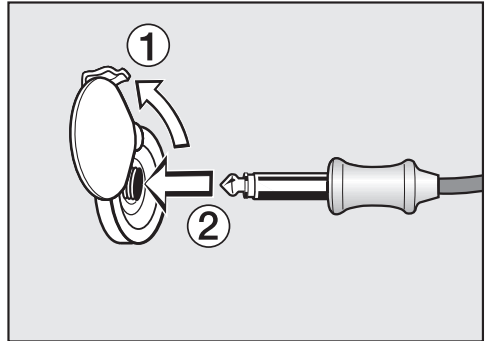

- Insert the plug of the food probe into the socket until you feel it engage.
- Close the door.
- Select the function or automatic programme.
- Set the temperature and the core temperature if necessary.

The core temperatures cannot be changed for the automatic programmes.

Follow the instructions on the display.

The cooking programme is brought to an end as soon as the core temperature is reached.

 Risk of injury caused by hot surfaces.

The food probe can get hot. You could burn yourself on it.

Wear oven gloves when removing the food probe from its socket.

Roasting

Delaying the start of a cooking programme with food probe

You can set the cooking process to start at a later time.

- Select **Change** | Open further settings and enter a time in the **Start at** field.
- In automatic programmes, select **Start later**.

The finish time can be calculated approximately because the duration of a cooking programme is about the same, whether or not the food probe is used.

You cannot set **Duration** and **Ready at** because the total cooking duration is determined by when the set core temperature is reached.

Using residual heat

The oven heating turns off shortly before the end of the cooking programme. The remaining heat in the oven is enough to finish the cooking programme.

Using the residual heat in the oven saves energy.

Energy save phase will appear in the display to show that the oven is in energy save mode. The measured core temperature is no longer visible.

The cooling fan continues to run, as does the hot air fan if a function using the fan has been chosen.

Once the core temperature has been reached, **Process finished** will appear in the display and a buzzer will sound if buzzer tones are switched on.

Tip: If the food is not yet cooked sufficiently, insert the food probe into another place and repeat the programme.

 Risk of injury caused by hot surfaces.

If you grill with the door open, hot air will escape from the oven instead of being cooled by the cooling fan. The control elements will get hot. Grill with the oven door closed.

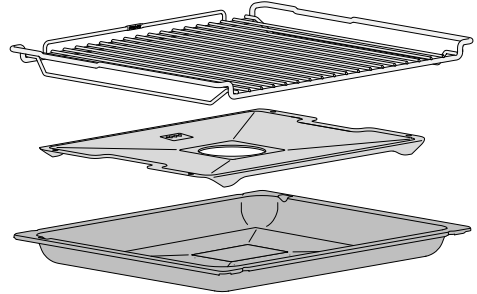

Do not use the baking tray.

Tips for grilling

- Pre-heating is necessary when grilling. Pre-heat the top heat/grill element for approx. 5 minutes with the door closed.
- Trim the meat if necessary. Do not season the meat with salt before grilling as this draws the juices out.
- Add a little oil to lean meat if necessary. Do not use other types of fat as they can easily burn and cause smoke.
- Clean fish in the normal way. To enhance the flavour, season with a little salt. Fish can also be drizzled with lemon juice.
- Use the universal tray with the wire rack placed on top of it. If you have a grilling and roasting insert, it should be placed in between them when using conventional cooking functions. The juices collect under the insert. This prevents them from spitting and making the oven dirty and they can then be used for making gravy and sauces.

- To grill, brush the wire rack with oil and then place the food on the wire rack.

Grilling

Notes on the cooking charts

You can find the cooking charts at the end of this book.

- Take note of the temperature range, the shelf levels and the durations. These take the size of the meat and cooking practices into account.
- Check the food after the shortest duration quoted.

Selecting the temperature

- As a general rule, select the lower temperature given in the chart. If higher temperatures are used than those specified, the meat will brown on the outside, but will not be properly cooked through.

Choosing a shelf level

- Select the shelf level depending on the thickness of the food to be cooked.
- Place flat food in shelf level 3 or 4.
- Place thicker food in shelf level 1 or 2.

Selecting the cooking duration

- Grill thinner cuts of meat/slices of fish for approx. 6–8 minutes per side. It is best to grill food of a similar thickness at the same time so that the cooking durations do not vary too much.
- As a general rule, check whether the food is cooked after the shortest duration.
- To **test the food**, press down on the meat with a spoon. This lets you determine how well the meat has been cooked.
 - **Rare/pink**
If the meat gives easily to the pressure of the spoon, it will still be red on the inside.
 - **Medium**
If there is some resistance, the inside will be pink.
 - **Well done**
If there is very little resistance, it is cooked through.

Tip: If the surface of a thicker cut of meat is browned but the centre is still raw, move the food to a lower level or reduce the temperature and continue grilling. This will stop the surface from becoming excessively charred.

Notes on the functions

You can find an overview of all the functions with their recommended values in “Main and sub-menus”.



The plastic on the food probe can melt at very high temperatures.

Do not use the food probe when using the grill functions.

Do not store the food probe in the oven compartment when it is not being used.

Using M Chef + Full grill and Full grill

Use these functions to grill flat thin cuts in large quantities and for browning large baked dishes.

When using the M Chef + Full grill  function, the food is cooked from the inside by electro-magnetic waves and at the same time browned on the outside by the whole of the top heat/grill element. Grilling times are shorter than with the Full grill  function.



Using Economy grill

Use this function to grill flat thin cuts in smaller quantities and for browning small baked dishes.

Only the centre of the top heat/grill element glows red to generate the required heat.

Using M Chef + Fan grill and Fan grill

Use these functions for grilling thicker food, such as chicken.

When using the M Chef + Fan grill  function, the food is cooked from the inside by electro-magnetic waves and at the same time browned on the outside by the top heat/grill element and the fan switching on and off alternately. Grilling times are shorter than with the Fan grill  function.

Cleaning and care

 Risk of injury caused by hot surfaces.

The Dialog oven gets hot when it is being used. You could burn yourself on the heater elements, oven compartment or accessories.

Allow the heater elements, oven compartment and accessories to cool before manual cleaning.

 Risk of injury due to electric shock.

The steam from a steam cleaning appliance could reach live electrical components and cause a short circuit.

Never use a steam cleaner for cleaning.

All surfaces can discolour or alter if unsuitable cleaning agents are used. The Dialog oven front is particularly susceptible to damage from oven cleaners and descaling agent. All surfaces are susceptible to scratching. Scratches on glass can in some circumstances lead to breakage.

Remove all cleaning agent residues immediately.

Unsuitable cleaning agents

To avoid damaging the surfaces, do not use:

- cleaning agents containing soda, ammonia, acids or chlorides
- cleaning agents containing descaling agents on the front
- abrasive cleaning agents (e.g. powder cleaners, scouring milk, scouring pads)
- solvent-based cleaning agents
- stainless-steel cleaning agents
- dishwasher cleaner
- glass cleaning agents
- cleaning agents for ceramic glass hobs
- hard, abrasive brushes or sponges (e.g. pot scourers, brushes or sponges which have been previously used with abrasive cleaning agents)
- melamine eraser blocks
- sharp metal scrapers
- wire wool
- spot cleaning with mechanical cleaning agents
- oven cleaners
- stainless-steel spiral pads

If soiling is left on for any length of time, it may become impossible to remove. If items are used frequently without being cleaned, it may become very difficult to clean them. It is therefore best to remove any soiling immediately.

The accessories are not dishwasher-safe.

Tip: Soiling caused by spilt fruit juices and cake mixtures is best removed while the oven compartment is still warm.

Removing normal soiling

There is a delicate fibreglass seal around the oven compartment to seal the glass in the oven door. This can be damaged by rubbing or scouring.
Avoid cleaning the fibreglass seal.

There are 2 seals around the door. These seals must never be removed.

Removing normal soiling

- Remove normal soiling immediately with warm water, washing-up liquid and a clean sponge or a clean, damp microfibre cloth.
- Remove all cleaning agent residues thoroughly with clean water. This is particularly important for any parts with a PerfectClean finish, as cleaning agent residues will impair the non-stick function.
- After cleaning, wipe the surfaces dry using a soft cloth.

Do not put the food probe into water or clean it in the dishwasher as this will damage it.
Clean the food probe with a damp cloth only.

Cleaning and care

Removing stubborn soiling

Spilt fruit and roasting juices may cause lasting discolouration or matt patches on surfaces. This discolouration will not affect the properties of the surface finish. Do not attempt to remove these stains. Only use the equipment specified.

- Baked-on deposits can be removed with a glass scraper or with a stainless-steel spiral pad (e.g. Spontex Spirinett), hot water and washing-up liquid.

Using oven cleaners

- Very stubborn soiling on PerfectClean surfaces can be cleaned using the Miele oven cleaner, which must only be applied to cold surfaces.

If the oven spray gets into gaps and openings, a strong odour is generated during subsequent cooking programmes.

Do not spray the oven cleaner onto the roof of the oven compartment.

Do not spray the oven cleaner into the gaps and openings of the oven compartment walls and rear wall.

- Follow the instructions on the packaging.

Oven cleaners from other manufacturers must only be used in a cold oven and for no longer than a maximum of 10 minutes.

- You can then also use the scouring pad on the back of a washing-up sponge to remove the soiling.
- Remove all cleaning agent residues thoroughly with clean water.
- Dry all surfaces with a soft cloth.

Cleaning the oven compartment by means of Pyrolytic

Instead of cleaning the oven compartment manually you can run the Pyrolytic  function.

During pyrolytic cleaning the oven compartment reaches temperatures in excess of 400 °C. Any residual soiling is burnt off and turned to ash by the high temperatures.

There are 3 pyrolytic settings available, each with a different duration:

- Level 1 for light soiling
- Level 2 for heavier soiling
- Level 3 for very heavy soiling

The oven door is automatically locked when the pyrolytic cleaning process is started. It cannot be opened until after the programme has finished.

The timer can be used to delay the start time of the pyrolytic cleaning programme, for instance to make use of cheaper electricity tariffs.

At the end of the pyrolytic cleaning programme any residues such as ash from the pyrolytic process, which may be formed depending on the oven compartment's degree of soiling, can be easily wiped away.

Preparing for pyrolytic cleaning

Accessories that are not suitable for pyrolytic cleaning will be damaged by the high temperatures.

Remove all accessories that are not suitable for pyrolytic cleaning from the oven compartment before starting the pyrolytic cleaning programme. This also applies for optional accessories that are not suitable for pyrolytic cleaning.

The accessories below are suitable for pyrolytic cleaning and can be left in the oven compartment during pyrolytic cleaning:

- Side runners
- Rack HBRR 52
- Remove all accessories that are not suitable for pyrolytic cleaning from the oven.
- Place the rack on the top shelf level.

Coarse soiling in the oven compartment can cause thick smoke to develop.

Burnt-on residues can cause lasting discolouration or matt spots on enamelled surfaces.

Before starting the pyrolytic cleaning programme, remove coarse soiling from the oven compartment and scrape any burnt-on residues off enamelled surfaces with a glass scraper.

Cleaning and care

Starting pyrolytic cleaning

 Risk of injury caused by hot surfaces.

The Dialog oven gets much hotter during pyrolytic cleaning than during normal use.

Do not let children touch the Dialog oven during Pyrolytic cleaning.

- Select Maintenance .
- Select Pyrolytic.
- Select the level required according to the amount of soiling.
- Confirm with *OK*.

Follow the instructions on the display.

- Confirm with *OK*.

You can start pyrolytic cleaning straight away or schedule it to begin at a later time.



Starting pyrolytic cleaning straight away

- To start the pyrolytic cleaning programme straight away, select *Start now*.
- Confirm with *OK*.

The pyrolytic cleaning programme will start.

The door will lock automatically. The oven heating and the cooling fan will then switch on automatically.

The time left for the pyrolytic cleaning programme will start counting down in the display. You cannot alter the duration.

You can use the minute minder at the same time as running the cleaning programme. At the end of the minute minder time the buzzer will sound,  will start flashing and the time can be viewed counting up in the display. When you touch the  sensor control, the acoustic and optical signals are switched off.

Starting pyrolytic cleaning at a later time

- To start the pyrolytic cleaning programme later, select *Start later*.
- Confirm with *OK*.
- Set the time at which pyrolytic cleaning should start.
- Confirm with *OK*.

The door will lock automatically. Start at and the start time set will appear in the display.

You can reset the start time via *Change* at any point up to the starting time.

As soon as the start time has been reached, the oven heating and cooling fan will switch on automatically and the time remaining will appear in the display.

Finalising pyrolytic cleaning

When the time left has fully elapsed, a message will appear in the display to tell you that the door is unlocking.

Process finished will appear in the display and a buzzer will sound as soon as the door has been unlocked.

- Switch the Dialog oven off.

The visual and acoustic signals will switch off.

 Risk of injury caused by hot surfaces.

At the end of the pyrolytic cleaning programme, the Dialog oven will still be very hot. You could burn yourself on the heater elements, oven compartment or accessories.

Allow the heater elements, oven compartment and accessories to cool down before removing any pyrolytic residues or oiling the side runners.

- Clean the oven compartment and accessories suitable for pyrolytic cleaning to remove any pyrolytic residues (e.g. ash) that can build up depending on the degree of soiling in the oven compartment.
- Add a few drops of heat-resistant cooking oil to some kitchen paper and use this to lubricate the side runners.

Most residues can be removed with hot water, a little washing-up liquid and a clean sponge or a clean, damp microfibre cloth.

There is a delicate fibreglass seal around the oven compartment to seal the glass in the oven door. This can be damaged by rubbing or scouring.

Avoid cleaning it where possible.

Enamelled surfaces can be permanently discoloured by spilt fruit juices. Such discolouration does not affect the properties of the enamel. Do not attempt to remove these stains.

Pyrolytic cleaning interrupted

The following events will cause the pyrolytic cleaning programme to stop:

- Switching the Dialog oven off.
- A power cut.

If pyrolytic cleaning is cancelled, the oven door will remain locked until the temperature inside the oven drops to below 280 °C.

If you switch the Dialog oven off, *Switch appliance off?* will appear in the display.

- If you want to cancel the pyrolytic cleaning programme, select *Yes*.

The door will unlock as soon as the temperature in the oven drops below 280 °C and the Dialog oven will switch off.

- If you want the pyrolytic cleaning programme to continue, select *No*.

The pyrolytic cleaning programme will then continue.

If there has been a power cut, *Pyrolytic - cancelled* will appear in the display once power is restored.

The door will unlock as soon as the temperature in the oven drops below 280 °C.

A buzzer sounds and *Process finished* appears.

- Select the  sensor control.
- Start the pyrolytic cleaning programme again.

Cleaning and care

Descale

The frequency of descaling will depend on the water hardness level in your area.

The descaling process can be run at any time.

However, to ensure that the oven functions correctly, you will be automatically prompted to run the descaling process for the steam injection system after a certain number of cooking processes.

The oven will count down in the display the last 10 cooking processes that can be run before it needs to be descaled. You will then not be able to run any operating mode or automatic programme using moisture assistance.

These operating modes can only be used again after you have carried out a descaling process. All other operating modes and automatic programmes without moisture assistance can still be used.

Descaling process sequence

Once the descaling process has been started it must be completed through to the end. It cannot be cancelled.

Descaling takes approx. 90 minutes and consists of several steps:

1. Preparing the descaling process
2. Drawing in the descaling solution
3. Activation phase
4. Rinse 1
5. Rinse 2
6. Rinse 3
7. Residual water evaporation

Preparing the descaling process

You will need a container of approx. 1 litre capacity.

A plastic tube (with suction cup) is supplied with your oven so that you do not have to hold the container with the descaling agent underneath the water intake pipe.

We recommend using the descaling tablets supplied. They have been specially developed for Miele for optimum results.

Tip: Miele descaling tablets are available to order from the Miele webshop, from the Miele Customer Service Department or from your Miele dealer.

Other descaling agents, which contain other acids besides citric acid and/or other undesirable substances, such as chlorides for example, could cause damage.

Moreover, the descaling result required could not be guaranteed if the descaling solution was not of the appropriate concentration.

- Fill the container with approx. 600 ml of cold tap water and thoroughly dissolve one descaling tablet in it.

Carrying out the descaling process

- Select Maintenance .
- Select Descale.

If the functions and automatic programmes with moisture are already disabled, the descaling process can be started immediately by touching **OK**.

- Push the universal tray into the top shelf level as far as it will go to collect the descaling solution after it has been used. Confirm the message shown with **OK**.

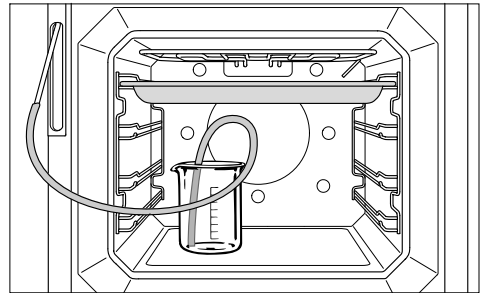

- Place the container with the descaling solution on the floor of the oven.
- Attach one end of the plastic tube to the water intake pipe. Place the other end of the plastic tube in the bottom of the descaling solution container and secure the plastic tube to the container with the suction cup.
- Confirm with **OK**.

The water intake process will begin. You will hear the noise of the pump.

You can interrupt and resume the intake process at any time by selecting **Stop** or **Start**.

Cleaning and care

The amount of solution specified can be more than the amount which is actually taken in. Some of the solution may therefore be left in the container at the end of descaling.

A message will appear to confirm that the intake process is completed.

- Confirm with *OK*.

The **activation phase** will begin. You can follow the time counting down in the display.

- Leave the container with the tube connected to the water intake pipe in the oven compartment. Top the container up with approx. 300 ml of water, as the system will need to draw in some more liquid during the activation phase.

The system will take in more liquid at approximately 5 minute intervals. You will hear the noise of the pump.

The cooling fan remains switched on for the whole duration of the process.

At the end of the activation phase, a buzzer will sound.

Rinsing the steam injection system after the activation phase

After the activation phase the steam injection system must be rinsed out to remove residues of descaling solution.

To do this approx. 1 litre of fresh tap water is pumped through the steam injection system three times and is collected in the universal tray.

- Take the universal tray with the collected descaling agent out of the oven and empty it. Place the tray back in the oven again on the top shelf level.
- Remove the plastic tube from the container.
- Remove the container, rinse it out thoroughly and fill it with approx. 1 litre of fresh tap water.
- Replace the container in the oven compartment and secure the plastic tube in the container.
- Confirm with *OK*.

The intake process for the **first rinse** will start.

The water is fed through the steam injection system and is collected in the universal tray.

Instructions for preparing the **second rinse** will appear.

- Take the universal tray with the collected rinse water out of the oven and empty it. Place the tray back in the oven again on the top shelf level.
- Remove the plastic tube from the container and fill it with approx. 1 litre of fresh tap water.
- Replace the container in the oven compartment and secure the plastic tube in the container.
- Confirm with *OK*.
- Proceed in exactly the same way for the **third rinse**.

Leave the universal tray with the collected rinse water from the third rinse in the oven compartment during residual moisture evaporation.

Evaporating residual moisture

After the third rinse residual moisture evaporation will commence.

- Remove the container and tube from the oven compartment.
- Close the door.
- Confirm with *OK*.

 Danger of injury caused by steam.
Steam can cause severe scalding.
Do not open the door while the residual water is being evaporated.

The oven heating will switch on and the duration of residual moisture evaporation will appear.

The duration is amended automatically depending on the actual amount of residual moisture.

Finalising the descaling process

At the end of residual water evaporation, an information window appears with tips on cleaning after the descaling process.

- Confirm with *OK*.

A buzzer sounds and *Process finished* appears.

- Switch the Dialog oven off with the On/Off  sensor control.

 Risk of injury caused by hot surfaces.

The Dialog oven gets hot when it is being used. You could burn yourself on the heater elements, oven compartment or accessories.





Allow the heater elements, oven compartment and accessories to cool before manual cleaning.

- Remove the universal tray with the collected fluid and empty it.
- When the oven compartment has cooled down, clean away any condensation and descaling agent residues.
- Leave the oven door open until the oven compartment is completely dry.

Problem solving guide

Many malfunctions and faults that can occur in daily operation can be easily remedied. Time and money will be saved because a service call will not be needed.

The following guide may help you to find the reason for a malfunction or a fault, and to correct it.

Problem	Cause and remedy
<p>The display is dark.</p>	<p>You have selected QuickTouch Off. When the Dialog oven is switched off, the display is switched off.</p> <ul style="list-style-type: none"> ■ As soon as the Dialog oven is turned on, the main menu will appear. If you want the time of day to be displayed constantly, select QuickTouch On with time. <hr/> <p>There is no power to the Dialog oven.</p> <ul style="list-style-type: none"> ■ Check whether the fuse has tripped. If it has, contact a qualified electrician or Miele Service.
<p>The buzzer does not sound.</p>	<p>The buzzers are deactivated or set at too low a volume.</p> <ul style="list-style-type: none"> ■ Switch on the buzzers or increase the volume with Settings Volume Buzzer tones.
<p>The oven compartment does not heat up.</p>	<p>Demo mode is activated.</p> <p>You can select menu options in the display and sensor controls, but the oven heating does not work.</p> <ul style="list-style-type: none"> ■ Deactivate demo mode by selecting Settings Showroom programme Demo mode Off.
<p>System lock  appears in the display when the oven is switched on.</p>	<p>The  system lock has been activated.</p> <ul style="list-style-type: none"> ■ You can deactivate the system lock for a cooking programme by touching the  symbol for at least 6 seconds. ■ If you want to permanently deactivate the system lock, select the Safety System lock  Off setting.
<p>Power cut -process cancelled appears in the display.</p>	<p>There has been a brief power cut. This has caused the current cooking programme to stop.</p> <ul style="list-style-type: none"> ■ Switch the Dialog oven off and then back on again. ■ Restart the cooking programme.
<p>12:00 appears in the display.</p>	<p>The power supply was interrupted for longer than 200 hours.</p> <ul style="list-style-type: none"> ■ Reset the time and date.



Problem solving guide

Problem	Cause and remedy
Maximum operating duration reached appears in the display.	<p>The Dialog oven has been operating for an unusually long time. This has triggered the safety switch-off function.</p> <ul style="list-style-type: none"> ■ Confirm with <i>OK</i>. Touch ↵ sensor control to delete the message <i>Process finished</i>. <p>The Dialog oven is ready to use again.</p>
F32 appears in the display.	<p>The Door lock for pyrolytic cleaning has not locked.</p> <ul style="list-style-type: none"> ■ Switch the Dialog oven off and then back on again. Start the pyrolytic cleaning programme again. ■ If the message appears again, contact Miele Service.
F33 appears in the display.	<p>The Door lock for pyrolytic cleaning has not opened.</p> <ul style="list-style-type: none"> ■ Switch the Dialog oven off and then back on again. ■ If the door lock still does not deactivate itself, contact Miele.
 Fault and a fault code not listed here appears in the display.	<p>A fault has occurred that you cannot resolve.</p> <ul style="list-style-type: none"> ■ Call the Miele Customer Service Department.
Function currently not available appears in the display after selecting the Descale function.	<p>The steam injection system is faulty.</p> <ul style="list-style-type: none"> ■ Call Miele Service.
Fault with moisture control - the automatic programmes will run without moisture appears in the display after selecting an Automatic programme.	<p>The steam injection system is faulty.</p> <ul style="list-style-type: none"> ■ Call Miele Service. <p>Automatic programmes can be run without using moisture.</p>
Programmes with moisture are not taking in water.	<p>Demo mode is activated. You can select menu options in the display and sensor controls, but the steam injection system pump will not work.</p> <ul style="list-style-type: none"> ■ Deactivate demo mode by selecting <i>Settings Showroom programme Demo mode Off</i>.
	<p>The pump for the steam injection system is faulty.</p> <ul style="list-style-type: none"> ■ Call the Miele Customer Service Department.

Problem solving guide

Problem	Cause and remedy
<p>During a cooking programme with an M Chef function, the cooling fan is running with a very high spin speed.</p>	<p>The Dialog oven can get much hotter when using M Chef functions than it does with conventional cooking functions. The spin speed will reduce automatically at the end of the cooking programme.</p> <ul style="list-style-type: none"> ■ If it happens too frequently, check that the appliance is correctly installed (see “Installation”). <p>With very small amounts of food in the oven (e.g. baking 2 rolls) the Dialog oven will heat up more than it would with larger amounts of food.</p> <ul style="list-style-type: none"> ■ It is better to cook larger amounts of food.
<p>A noise can be heard after a cooking programme.</p>	<p>The cooling fan remains switched on after a cooking programme (see “Settings – Cooling fan run-on”).</p>
<p>The Dialog oven has switched itself off.</p>	<p>The Dialog oven will switch itself off automatically to save energy if no other action is taken within a certain time frame after switching it on or after the end of a cooking programme.</p> <ul style="list-style-type: none"> ■ Switch the Dialog oven back on again.
<p>The food is unevenly cooked.</p>	<p>If food has browned too much in certain places, the temperature selected was too high.</p> <ul style="list-style-type: none"> ■ Select a lower temperature. <p>If there are hard bits or dry areas on the food, the intensity was set too high.</p> <ul style="list-style-type: none"> ■ Set a lower intensity level or set few Gourmet units.
<p>Cakes/biscuits are not cooked properly after the duration given in the cooking chart.</p>	<p>A different temperature from the one given in the recipe was used.</p> <ul style="list-style-type: none"> ■ Select the temperature required for the recipe. <p>The ingredient quantities are different from those given in the recipe.</p> <ul style="list-style-type: none"> ■ Check whether you amended the recipe. The addition of more liquid or more eggs makes a moister mix which requires a longer cooking duration.

Problem solving guide

Problem	Cause and remedy
<p>The food is not sufficiently browned after adding the set number of Gourmet units.</p>	<p>A temperature has been set that is too low.</p> <ul style="list-style-type: none"> ■ Select a higher temperature. For a more intensive browning level, finish cooking the food using a conventional function.
<p>The browning of cakes/biscuits is uneven.</p>	<p>The wrong temperature or shelf level was selected.</p> <ul style="list-style-type: none"> ■ There will always be a slight unevenness in browning. If browning is very uneven, check whether the correct temperature and shelf level were selected.
	<p>The material or colour of the bakeware is not suitable for the oven function selected.</p> <ul style="list-style-type: none"> ■ Light-coloured and shiny bakeware is not very suitable for the M Chef + Conventional heat  and Conventional heat  functions. Dark, matt bakeware is best for baking. ■ It is best to use metal baking tins with M Chef functions if possible. Bakeware made from silicone, glass or ceramic and bakeware with a silicone underlay may prevent the underside browning sufficiently.
	<p>The catalyser for odour reduction is switched on. This can lead to an uneven browning result on more delicate food such as sponge cakes and biscuits.</p> <ul style="list-style-type: none"> ■ Select the Catalyser Off setting.
<p>There is still soiling in the oven compartment after a pyrolytic cleaning programme.</p>	<p>The pyrolytic cleaning programme burns off soiling in the oven and leaves it as ash.</p> <ul style="list-style-type: none"> ■ Remove the ash using a damp microfibre cloth or with a clean sponge and a solution of hot water and washing-up liquid. <p>If there is still coarse soiling left in the oven after the pyrolytic cleaning programme you should start the programme again, selecting a longer duration if necessary.</p>

Problem solving guide

Problem	Cause and remedy
The accessories make noises when being pushed into or pulled out of the oven.	<p>The pyrolytic resistant surface of the side runners creates friction when accessories are being pushed into or pulled out of the oven.</p> <ul style="list-style-type: none">■ To reduce the friction, add a few drops of heat resistant cooking oil to some kitchen paper and use this to lubricate the side runners. Repeat this after every pyrolytic cleaning programme.
The oven lighting does not switch on.	<p>The oven interior lighting is faulty.</p> <ul style="list-style-type: none">■ Call Miele Service.

Contact in the event of a fault

In the event of any faults which you cannot remedy yourself, please contact your Miele dealer or the Miele Customer Service Department.

You can book a Miele Customer Service Department call-out online at www.miele.com/service.

Contact information for the Miele Customer Service Department can be found at the end of this document.

Please quote the model identifier and serial number of your appliance (Fabr./SN/Nr.) when contacting the Miele Customer Service Department. This information can be found on the data plate.

Please note that telephone calls may be monitored and recorded for training purposes and that a call-out charge will be applied to service visits where the problem could have been resolved as described in this booklet.

This information is given on the data plate, which is visible on the front frame of the oven when the door is fully open.

Warranty

For information on the appliance warranty specific to your country please contact Miele. See back cover for address.

In the UK, your appliance warranty is valid for 2 years from the date of purchase. However, you must activate your cover by calling 0330 160 6640 or registering online at www.miele.co.uk.

Installation

Installation dimensions

Dimensions are given in mm.

Installation in a tall or base unit

If the Dialog oven is to be installed in a base unit underneath a hob, please also observe the installation instructions for the hob as well as the building-in depth required for the hob.

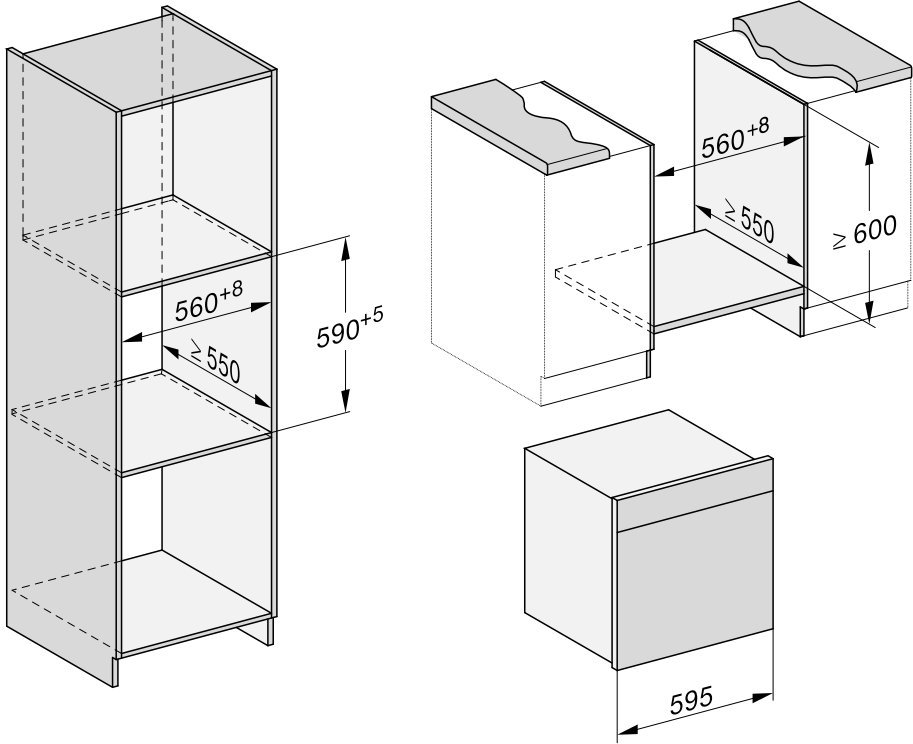

Side view

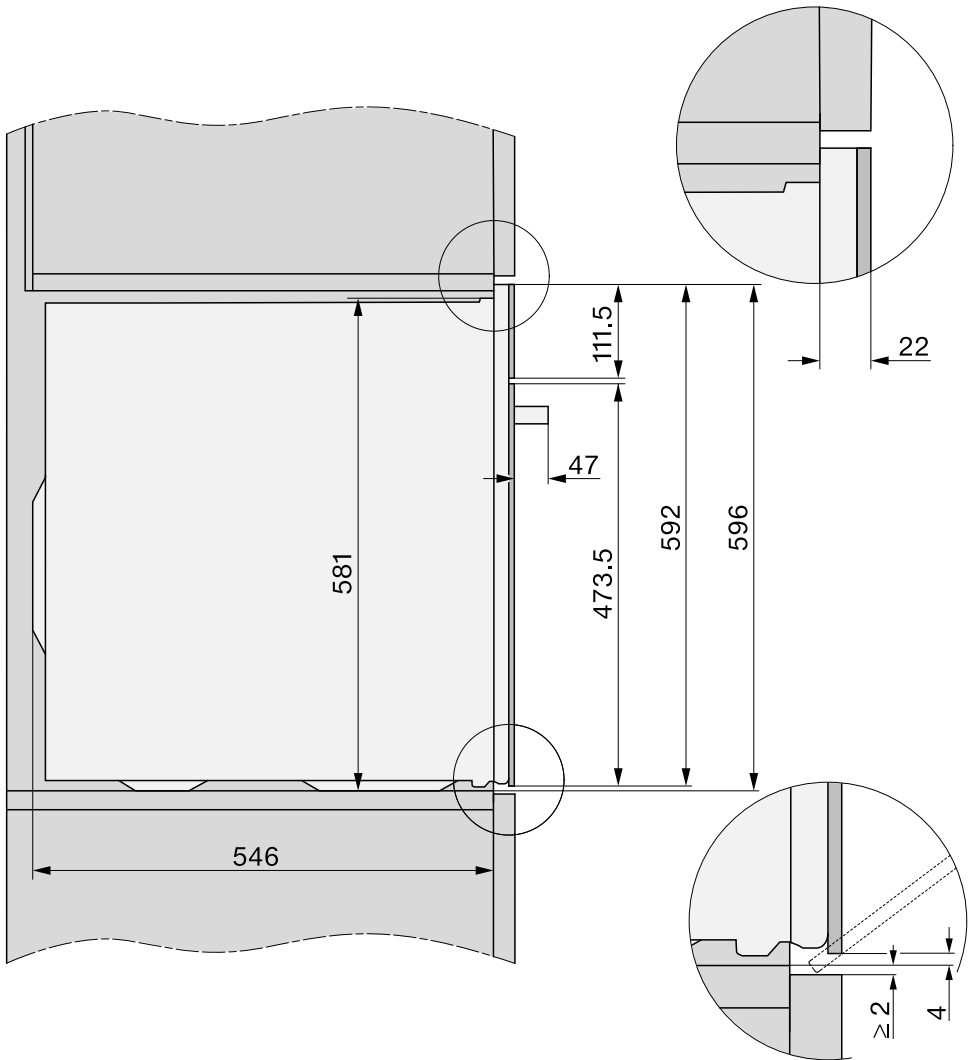

Installation

Connections and ventilation

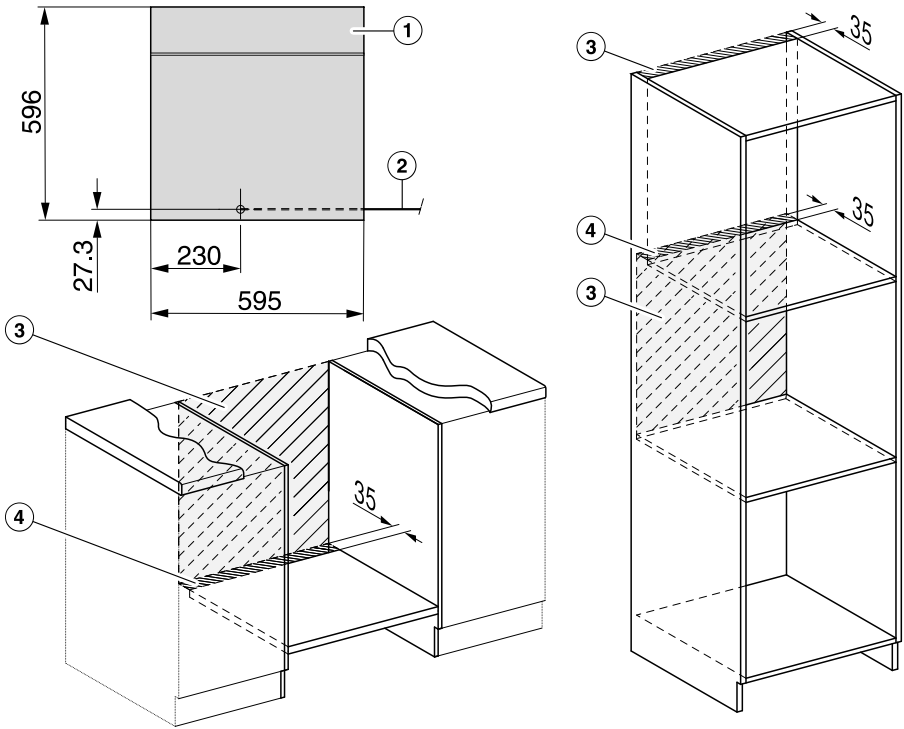

- ① Front view
- ② Mains connection cable, length = 2000 mm
- ③ No connections permitted in this area
- ④ Ventilation cut-out, min. 150 cm²

Installing the Dialog oven

For safety reasons, the Dialog oven may only be used when it has been fully installed.

The Dialog oven requires a sufficient supply of cool air for efficient operation. The required supply of cool air must not be excessively heated by other heat sources (e.g. solid fuel stoves).

The following must be observed when installing the appliance:

Do not fit a back panel in the housing unit.

Ensure that the interim shelf that the Dialog oven sits on does not abut the wall.

Do not fit heat insulation strips to the side panels of the housing unit.

- Before starting installation work, ensure that there is no power to the socket.
- Connect the Dialog oven to the electrical supply.

Lifting the Dialog oven by the door handle could cause damage to the door.

Use the handles on the side of the casing to lift the appliance.

- Push the Dialog oven into the housing unit and align it.
- Open the door.

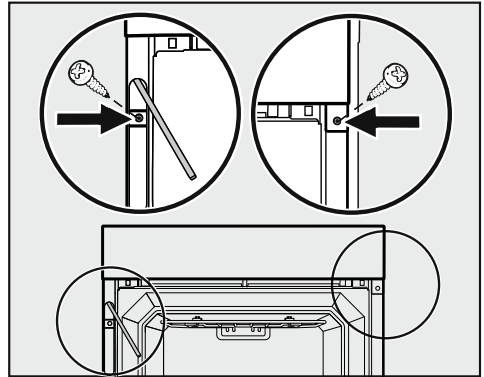

- Pull the water intake pipe forwards (located below the control panel on the left).
- Secure the Dialog oven to the side panels of the housing unit using the screws supplied.

Installation

Electrical connection

All electrical work should be carried out by a suitably qualified and competent Miele approved service technician in strict accordance with current national and local safety regulations (BS 7671 in the UK).

This appliance is supplied with a mains cable for connection to a 220–240 V, 50 Hz single phase supply.

The fuse rating must be at least 16 A.

The voltage and connected load are given on the data plate situated at the front of the Dialog oven interior. Please ensure that these match the household mains supply.

Connection should be made via a fused connection unit or a suitable isolator, which complies with national and local safety regulations, and the on/off switch should be easily accessible after the appliance has been installed.

If the switch is not accessible after installation (depending on country) an additional means of disconnection must be provided for all poles.

Switches with a minimum all-pole contact gap of 3 mm are suitable for isolating the appliance. These include circuit breakers, fuses and protective devices.

For extra safety it is advisable to protect the appliance with a suitable residual current device (RCD). Please contact a qualified electrician for advice.

If the cable is damaged a new cable must be fitted by a Miele approved service technician.

This appliance conforms with European Standard EN 55011 as a Group 2, Class B product. Group 2 appliances use high frequency energy in the form of electro-magnetic waves to create heat in food. Class B is assigned to appliances that are suitable for domestic use.

Important UK

The wires in the mains lead are coloured in accordance with the following code:

- Green/yellow = earth
- Blue = neutral
- Brown or black = live

 **WARNING - THIS APPLIANCE MUST BE EARTHED**

Temporary or permanent operation on an autonomous power supply system or a power supply system that is not synchronised with the mains power supply (e.g. island networks, back-up systems) is possible. A prerequisite for operation is that the power supply system complies with the specifications of EN 50160 or an equivalent standard. The function and operation of the protective measures provided in the domestic electrical installation and in this Miele product must also be maintained in isolated operation or in operation that is not synchronised with the mains power supply, or these measures must be replaced by equivalent measures in the installation. As described, for example, in the current version of BS OHSAS 18001–2 ISO 45001.

Electrical connection: Other countries

All electrical work should be carried out by a suitably qualified and competent Miele approved service technician in strict accordance with local and national safety regulations.

The voltage and rated load are given on the data plate situated at the front of the oven interior. Please ensure that these match the household mains supply.

For extra safety it is advisable to install a suitable residual current device (RCD) / ground fault interrupter (GFI). Contact a qualified electrician for advice.

If the cord is damaged a new cord must be fitted by a Miele approved service technician.

 **WARNING - THIS APPLIANCE MUST BE EARTHED**

Hong Kong

This appliance is supplied with a power cord with plug for connection to a 230 V, 50 Hz socket outlet.



























Taiwan









This appliance is supplied with a power cord with plug for connection to a 220 V, 60 Hz socket outlet.

Temporary or permanent operation on an autonomous power supply system or a power supply system that is not synchronised with the mains power supply (e.g. island networks, back-up systems) is possible. A prerequisite for operation is that the power supply system complies with the specifications of EN 50160 or an equivalent standard. The function and operation of the protective measures provided in the domestic electrical installation and in this Miele product must also be maintained in isolated operation or in operation that is not synchronised with the mains power supply, or these measures must be replaced by equivalent measures in the installation. As described, for example, in the current version of BS OHSAS 18001–2 ISO 45001.

Cooking charts

Batter

Cakes/biscuits (accessories)		 [°C]		 4 1	GU	INT	 [min]	CF
Muffins (tray)		165	✓	2	150		25–35	–
		150–160	–	2	–	–	40–50	–
Small cakes (1 tray)*		150	–	2	–	–	30–40	–
		170 ¹	–	2	–	–	15–25	–
Small cakes (2 trays)*		150 ¹	–	2+3	–	–	30–40	–
Madeira cake (loaf tin, 30 cm)		170	–	2	--		35–45	–
		160–170 ¹	–	2	–	–	60–70	–
Marble cake (loaf tin, 30 cm/ring cake tin, Ø 26 cm)		200	–	2	200		30–40	–
		170–180	–	2	–	–	60–70	–
Marble cake (Bundt cake tin, Ø 26 cm)		200	–	2	250		30–40	–
		170–180	✓	2	–	–	60–70	–
Nut cake (loaf tin, 30 cm)		160	–	2	250		50–60	✓
		150–160	–	2	–	–	65–75	–
Nut cake (ring cake tin/Bundt cake tin, Ø 26 cm)		160	✓	2	270		40–50	–
		150–160	✓	2	–	–	65–75	–
Ring cake (Bundt cake tin, Ø 26 cm)		180	–	2	280		55–65	–
		150–160	–	2	–	–	80–90	–
Fresh fruit cake (tray)		180	–	2	220		25–35	✓
		160–170	–	1	–	–	40–50	✓
Fresh fruit cake (springform cake tin, Ø 26 cm)		160	✓	2	300		40–50	✓
		160–170	–	2	–	–	55–65	✓
Flan base (flan base tin, Ø 28 cm)		160–170	–	2	–	–	30–40	–

 Function,  Temperature,  Rapid heat-up or Pre-heat (depending on function),  Shelf level, GU Gourmet Units, INT Intensity (| Gentle, || Medium, ||| Strong),  Duration, CF Crisp function,  M Chef + Fan plus,  Fan plus,  M Chef + Conventional heat,  Conventional heat, ✓ On, – Off, -- No value set

* The settings also apply for testing in accordance with EN 60350-1.

¹ Pre-heat the oven before putting food inside.

Shortcrust pastry

Cakes/biscuits (accessories)		[°C]		1	GU	INT	[min]	CF
Biscuits (1 tray)		150–160	-	2	-	-	25–35	-
Biscuits (2 trays)		150–160	-	2+3	-	-	25–35 ²	-
Drop cookies (1 tray)*		140	-	2	-	-	18–25	-
		160 ¹	-	3	-	-	25–30	-
Drop cookies (2 trays)*		140	-	2+3	-	-	60–70 ²	-
Flan base (flan base tin, Ø 28 cm)		180–190 ¹	-	2	-	-	20–30	-
Cheesecake (springform cake tin, Ø 26 cm)		155	-	2	200		55–65	-
		150–160	-	2	-	-	85–95	-
Apple pie, single crust (springform cake tin, Ø 20 cm)*		170	-	2	-	-	90–100	-
		180	-	2	-	-	70–80	-
Apple pie, double crust (springform cake tin, Ø 26 cm)		180	-	2	300		40–50	✓
		170–180	-	2	-	-	65–75	-
Fresh fruit cake, glazed (springform cake tin, Ø 26 cm)		170	-	2	300		45–55	-
		160–170	-	2	-	-	65–75	-
Fresh fruit cake, glazed (tray)		180	-	2	250		50–60	✓
		160–170	-	2	-	-	65–75	✓
Fruit flan (tray)		210–220	✓	1	250		35–45	✓
		190–200	-	2	-	-	55–65	✓

Function, Temperature, Rapid heat-up or Pre-heat (depending on function), Shelf level, GU Gourmet Units, INT Intensity (| Gentle, || Medium, ||| Strong), Duration, CF Crisp function, M Chef + Fan plus, Fan plus, M Chef + Conventional heat, Conventional heat, M Chef + Intensive bake, Intensive bake, ✓ On, – Off

* The settings also apply for testing in accordance with EN 60350-1.

1 Pre-heat the oven before putting food inside.

2 Take the trays out of the oven early if the food is sufficiently browned before the specified cooking duration has elapsed.

Cooking charts

Yeast dough

Cakes/biscuits (accessories)		[°C]		4	GU	INT	[min]	CF
Bundt cake (Bundt cake tin, Ø 24 cm)		180	-	2	180		40-50	-
		170-180	-	2	-	-	55-65	-
Stollen		170	-	2	180		40-50	-
		150-160	-	2	-	-	70-80	-
Streusel cake with/without fruit (tray)		190	-	2	200		35-40	✓
		170-180	-	2	-	-	45-55	✓
Fresh fruit cake (tray)		190	-	3	200		35-40	✓
		200	✓	3	-	-	45-55	✓
Raisin whirls (tray)		180	✓	2	140		20-30	-
		160-170	-	2	-	-	35-45	-
White bread (free-form), in 2 cooking stages		200	✓	2	-	-	12 ⁴	-
	1				100		20-30	
White bread (loaf tin, 30 cm)		200	✓	2	170		30-40 ⁵	-
Wholegrain bread (loaf tin, 30 cm), in 2 cooking stages		220	✓	2	-	-	25 ⁵	-
		180 ²	-				25-35	
Proving yeast dough		30-35	-	- ³	-	-	15-60	-

Function, Temperature, Rapid heat-up or Pre-heat (depending on function), 4 Shelf level, GU Gourmet Units, INT Intensity (| Gentle, || Medium, ||| Strong), Duration, CF Crisp function, M Chef + Fan plus, Fan plus, M Chef + Conventional heat, Conventional heat, Moisture plus with method of heating Fan plus, Moisture plus with method of heating Conventional heat, ✓ On, - Off

- 1 Continue cooking with the new function.
- 2 Reduce the temperature after the specified cooking duration and continue cooking.
- 3 Place the wire rack on the floor of the oven and stand the bowl containing the dough on the wire rack.
- 4 2 bursts of steam | Manual: Release the first burst of steam straight after placing the food in the oven and the second burst of steam after 5 minutes.
- 5 2 bursts of steam | Time controlled: Release the first burst of steam 1 minute after placing the food in the oven and the second burst of steam after 7 minutes.

Quark dough

Cakes/biscuits (accessories)		[°C]		4 1	GU	INT	[min]	CF
Streusel cake with/without fruit (tray)		190	-	3	200		35-40	✓
		170-180	-	3	-	-	45-55	✓
Apple turnovers (tray)		180	-	2	130		20-30	-
		160-170	-	2	-	-	30-40	-

Function, Temperature, Rapid heat-up or Pre-heat (depending on function), Shelf level, GU Gourmet Units, INT Intensity (| Gentle, || Medium, ||| Strong), Duration, CF Crisp function, M Chef + Fan plus, M Chef + Conventional heat, Conventional heat, ✓ On, - Off

Sponge mixture

Cakes/biscuits (accessories)		[°C]		4 1	GU	INT	[min]	CF
Sponge cake base (2 eggs, springform cake tin, Ø 26 cm)		180	-	2	70		15-20	-
		170-180	-	2	-	-	25-30	-
Sponge cake base (4-6 eggs, springform cake tin, Ø 26 cm)		180	✓	2	150		20-25	✓
		170-180 ¹	-	2	-	-	40-50	✓
Whisked sponge (springform cake tin, Ø 26 cm)*		170-180	-	2	-	-	30-40	-
		160-170 ¹	-	2	-	-	25-35	-
Swiss roll sponge (tray)		180-190	✓	2	-	-	15-20	-













Function, Temperature, Rapid heat-up or Pre-heat (depending on function), Shelf level, GU Gourmet Units, INT Intensity (| Gentle, || Medium, ||| Strong), Duration, CF Crisp function, M Chef + Fan plus, Fan plus, M Chef + Conventional heat, Conventional heat, ✓ On, - Off









* The settings also apply for testing in accordance with EN 60350-1.

¹ Pre-heat the oven before putting food inside.

Cooking charts

















Choux pastry, puff pastry, meringue









Cakes/biscuits (accessories)		 [°C]			GU	INT	 [min]	CF
Choux buns (tray)		190	-	2	350		30-40	✓
		190 ¹	-	2	-	-	35-45	✓
Pastry puffs (tray)		210	✓	2	130		15-25	-
		180-190	-	2	-	-	30-40	-
Macaroons (1 tray)		120-130	-	2	-	-	40-50	✓
Macaroons (2 trays)		120-130	-	2+3	-	-	45-55	✓
Apple strudel (tray)		220 ¹	-	2	120		30-40	✓
		200-210 ¹	-	2	-	-	45-55	✓

 Function,  Temperature,  Rapid heat-up or Pre-heat (depending on function),
 Shelf level, GU Gourmet Units, INT Intensity (| Gentle, || Medium, ||| Strong),  Duration,
 CF Crisp function,  M Chef + Fan plus,  Fan plus,  M Chef + Conventional heat,
 Conventional heat, ✓ On, - Off

¹ Pre-heat the oven before putting food inside.

Savoury dishes

Food (accessories)		 [°C]		 ⁴	GU	INT	 [min]	CF
Savoury flan, shortcrust pastry (tray)		240	✓	2	220		25–35	✓
		200–210	✓	2	–	–	45–55	✓
Onion tart (tray)		190	✓	2	250		35–45	✓
		180–190	✓	2	–	–	50–60	✓
Pizza, yeast dough (tray)		220	✓	2	100		25–35	✓
		200–210 ³	–	2	–	–	35–45	✓
Pizza, quark dough (tray)		200–210 ³	–	3	–	–	35–45	✓
Toast* (wire rack)		300 ⁴	✓	3	–	–	5–8	–
Baked dishes/gratins (e.g. toast) (wire rack on universal tray)	 ²	250 ⁴	✓	3	–	–	4–7	–
Grilled vegetables (wire rack and universal tray) ¹	 ²	275 ⁴	✓	4/3	–	–	5–10 ⁵	–
Corn on the cob (wire rack on universal tray)		300 ⁴	✓	3	–	–	15–25 ⁶	–





















 Function,  Temperature,  Rapid heat-up or Pre-heat (depending on function), ⁴ Shelf level, GU Gourmet Units, INT Intensity (| Gentle, || Medium, ||| Strong),  Duration, CF Crisp function,  M Chef + Conventional heat,  Conventional heat,  Full grill, ✓ On, – Off











* The settings also apply for testing in accordance with EN 60350-1.

- 1 Place the wire rack on shelf level 4 and the universal tray on shelf level 3.
- 2 Depending on the amount, you can also use the Economy grill  function.
- 3 Pre-heat the oven before putting food inside.
- 4 Pre-heat the oven for 5 minutes before putting food inside.
- 5 Turn the food halfway through cooking.
- 6 Rotate the food several times during the cooking programme.

Cooking charts

Beef

Food (accessories)		 [°C]		 ⁴	GU	INT	 [min]	 [°C]
Braised beef, approx. 1 kg (roasting dish with lid)	 ²	150–160	✓	2	–	–	130–140 ⁶	--
Fillet of beef (rare), approx. 1.3 kg (wire rack on universal tray) ¹	 ²	120 ³	✓	2	60		30–40	45–48
	 ²	130 ³ 100 ⁴	✓	2	–	–	50–60	45–48
Fillet of beef (medium), approx. 1.3 kg (wire rack on universal tray) ¹	 ²	120 ³	✓	2	60		55–65	54–57
	 ²	130 ³ 100 ⁴	✓	2	–	–	110–120	54–57
Fillet of beef (well done), approx. 1.3 kg (wire rack on universal tray) ¹	 ²	120 ³	✓	2	60		130–140	63–66
	 ²	130 ³ 100 ⁴	✓	2	–	–	200–210	63–66
Sirloin joint (rare), approx. 1 kg (wire rack on universal tray) ¹	 ²	120 ³	✓	2	70		30–40	45–48
	 ²	130 ³ 100 ⁴	✓	2	–	–	50–60	45–48
Sirloin joint (medium), approx. 1 kg (wire rack on universal tray) ¹	 ²	120 ³	✓	2	70		55–65	54–57
	 ²	130 ³ 100 ⁴	✓	2	–	–	110–120	54–57
Sirloin joint (well done), approx. 1 kg (wire rack on universal tray) ¹	 ²	120 ³	✓	2	70		130–140	63–66
	 ²	130 ³ 100 ⁴	✓	2	–	–	200–210	63–66
Burgers/meat patties (wire rack on universal tray) ^{*1}		300 ⁵	✓	3	–	–	15–25 ⁷	--



















 Function,  Temperature,  Rapid heat-up or Pre-heat (depending on function), ⁴ Shelf level, GU Gourmet Units, INT Intensity (| Gentle, || Medium, ||| Strong),  Duration,  Core temperature,  Fan plus,  M Chef + Conventional heat,  Special application Low temp. cooking,  Full grill, ✓ On, – Off













* The settings also apply for testing in accordance with EN 60350-1.

- 1 Slide the wire rack and universal tray into the oven during the heating-up phase.
- 2 Sear the meat on the hob first.
- 3 Pre-heat the oven for 15 minutes before putting food inside.
- 4 Reduce the temperature after the heating-up phase and continue cooking.
- 5 Pre-heat the oven for 5 minutes before putting food inside.
- 6 Add approx. 0.25 litres of liquid at the start of the cooking programme and roast with the lid on to start with. Remove the lid 100 minutes into the cooking duration and add around another 0.25 litres of liquid. Continue cooking.
- 7 Turn the food halfway through cooking.

Cooking charts

Pork



















Food (accessories)		 [°C]		 ⁴	GU	INT	 [min]	 [°C]
Pork joint/pork neck roast, approx. 1.5 kg (roasting dish)		150	✓	2	--		110–120 ¹⁰	85
Pork joint/pork neck roast, approx. 1.5 kg (roasting dish with lid)		170–180	✓	2	-	-	120–150 ¹¹	80–90
Pork joint with crackling, approx. 2 kg (roasting dish), in 2 cooking stages	 ³	130	-	2	-	-	70	80–90
	 ⁴	200						
Pork tenderloin, approx. 350 g (roasting dish)		200	✓	2	150		15–25	--
Pork tenderloin, approx. 350 g (wire rack on universal tray) ¹		130 ⁷	-	2	-	-	70–90	60–69
		90–100 ⁸						
Gammon, approx. 1 kg (dish and wire rack)		140	-	2	500		70–80 ¹²	--
Gammon joint, approx. 1 kg (wire rack on universal tray) ¹		130 ⁷	-	2	-	-	140–160	63–66
		95–105 ⁸						
Meat loaf, approx. 1 kg (dish and wire rack)		230	✓	2	--		40–50 ¹³	75
Meat loaf, approx. 1 kg (universal tray)		190–200	✓	2	-	-	70–80	75–85
Bacon (wire rack and universal tray) ²		275 ⁹	✓	4/3	-	-	4–6	--
Sausages (wire rack on universal tray)		300 ⁹	✓	3	-	-	15–25 ¹⁴	--









 Function,  Temperature,  Rapid heat-up or Pre-heat (depending on function), ⁴ Shelf level, GU Gourmet Units, INT Intensity (| Gentle, || Medium, ||| Strong),  Duration,  Core temperature,  M Chef + Fan plus,  Fan plus,  M Chef + Conventional heat,  Conventional heat,  Moisture plus,  Special application Low temp. cooking,  Full grill, ✓ On, - Off, -- No value set

- 1 Slide the wire rack and universal tray into the oven during the heating-up phase.
- 2 Place the wire rack on shelf level 4 and the universal tray on shelf level 3.
- 3 3 bursts of steam | Time controlled: Release the first burst of steam 5 minutes after placing the food in the oven, the second burst of steam after 20 minutes and the third burst of steam after 50 minutes.
Increase the temperature after 50 minutes. Turn the meat, add approx. 0.5 litres of liquid and continue cooking.
- 4 Change the function after 70 minutes, reduce the temperature and continue cooking.
- 5 Sear the meat on the hob first.
- 6 Depending on the amount, you can also use the Economy grill  function.
- 7 Pre-heat the oven for 15 minutes before putting food inside.
- 8 Reduce the temperature after the heating-up phase and continue cooking.
- 9 Pre-heat the oven for 5 minutes before putting food inside.
- 10 Add approx. 0.5 litres of liquid after cooking for 30 minutes.
- 11 Roast with the lid on to start with. Remove the lid 60 minutes into the cooking duration and add approx. 0.5 litres of liquid.
- 12 Add approx. 0.25 litres of liquid at the start of the cooking programme.
- 13 Add approx. 0.25 litres of liquid after cooking for 15 minutes.
- 14 Turn the food halfway through cooking.

Cooking charts













Veal









Food (accessories)		 [°C]		 ⁴	GU	INT	 [min]	 [°C]
Braised veal, approx. 1 kg (roasting dish with lid)	 ²	160	✓	2	-	-	120-130 ⁴	--
Fillet of veal (pink), approx. 1 kg (wire rack on universal tray) ¹	 ²	120 ³	✓	2	70		30-40	45-48
	 ²	120 ³	✓	2	-	-	50-60	45-48
Fillet of veal (medium), approx. 1 kg (wire rack on universal tray) ¹	 ²	120 ³	✓	2	70		55-65	54-57
	 ²	120 ³	✓	2	-	-	110-120	54-57
Fillet of veal (well done), approx. 1 kg (wire rack on universal tray) ¹	 ²	120 ³	✓	2	70		130-140	63-66
	 ²	120 ³	✓	2	-	-	200-210	63-66
Saddle of veal (pink), approx. 1 kg (wire rack on universal tray) ¹	 ²	120 ³	✓	2	70		30-40	45-48
	 ²	120 ³	✓	2	-	-	50-60	45-48
Saddle of veal (medium), approx. 1 kg (wire rack on universal tray) ¹	 ²	120 ³	✓	2	70		55-65	54-57
	 ²	120 ³	✓	2	-	-	110-120	54-57
Saddle of veal (well done), approx. 1 kg (wire rack on universal tray) ¹	 ²	120 ³	✓	2	70		130-140	63-66
	 ²	120 ³	✓	2	-	-	200-210	63-66

 Function,  Temperature,  Rapid heat-up or Pre-heat (depending on function), ⁴ Shelf level, GU Gourmet Units, INT Intensity (| Gentle, || Medium, ||| Strong),  Duration,  Core temperature,  Fan plus,  M Chef + Conventional heat,  Special application Low temp. cooking, ✓ On, - Off

- 1 Slide the wire rack and universal tray into the oven during the heating-up phase.
- 2 Sear the meat on the hob first.
- 3 Pre-heat the oven for 15 minutes before putting food inside.
- 4 Roast with the lid on to start with. Remove the lid 90 minutes into the cooking duration and add approx. 0.5 litres of liquid.

Lamb, game

Food (accessories)		 [°C]		 ⁴	GU	INT	 [min]	 [°C]
Leg of lamb on the bone, approx. 1.5 kg (roasting dish)	 ²	150	✓	2	280		80–110 ⁵	64–82
		170–180	–	2	–	–	80–120	64–82
Saddle of lamb, off the bone (wire rack on universal tray) ¹	 ²	130 ³ 95–105 ⁴	–	2	–	–	40–60	54–66
		180–190 ³	–	2	–	–	15–25	54–66
Saddle of venison, off the bone (universal tray)	 ²	160–170 ³	–	2	–	–	70–90	60–80
Roebuck saddle, off the bone (universal tray)	 ²	140–150 ³	–	2	–	–	25–35	60–80
Leg of wild boar, off the bone, approx. 1 kg (roasting dish)	 ²	150	✓	2	220		70–90 ⁶	75–85

 Function,  Temperature,  Rapid heat-up or Pre-heat (depending on function), ⁴ Shelf level, GU Gourmet Units, INT Intensity (| Gentle, || Medium, ||| Strong),  Duration,  Core temperature,  M Chef + Fan plus,  Conventional heat,  Special application Low temp. cooking, ✓ On, – Off

- Slide the wire rack and universal tray into the oven during the heating-up phase.
- Sear the meat on the hob first.
- Pre-heat the oven for 15 minutes before putting food inside.
- Reduce the temperature after the heating-up phase and continue cooking.
- Roast with the lid on to start with. Remove the lid 40 minutes into the cooking duration and add approx. 0.5 litres of liquid.
- Roast with the lid on to start with. Remove the lid 30 minutes into the cooking duration and add approx. 0.5 litres of liquid.

Cooking charts

Poultry, fish

Food (accessories)		[°C]		4	GU	INT	[min]	[°C]	CF
Poultry, 0.8–1.5 kg (wire rack on universal tray)		230	✓	2	--		30–40	75	✓
		170–180	–	2	–	–	55–65	80–85	✓
Chicken, approx. 1.2 kg (wire rack on universal tray)		190 ¹	✓	2	–	–	65–75 ³	--	–
Poultry, approx. 2 kg (e.g. duck) (roasting dish)		190 220 ²	–	2	350		90–110 ⁴	90	✓
		180–190	✓	2	–	–	100–120 ⁵	85–90	✓
Poultry, approx. 4 kg (e.g. goose) (roasting dish)		160–170	✓	2	–	–	180–200	90–95	✓
Fish, 200–300 g (e.g. trout) (universal tray)		200	✓	2	100		10–20	70–75	–
		220–230	✓	2	–	–	20–30 ⁶	70–75	–
Trout, 2 pieces weighing 230–250 g each (universal tray)		225 ¹	✓	2	–	–	12–17 ³	--	–
Fish, 1–1.5 kg (e.g. salmon trout, char) (universal tray)		225	✓	2	--		20–30	70–75	–

Function, Temperature, Rapid heat-up or Pre-heat (depending on function), Shelf level, GU Gourmet Units, INT Intensity (| Gentle, || Medium, ||| Strong), Duration, Core temperature, CF Crisp function, M Chef + Fan plus, Fan plus, Conventional heat, Auto roast, Fan grill, Moisture plus with method of heating Conventional heat, ✓ On, Full grill, – Off, -- No value set

- 1 Pre-heat the oven for 5 minutes before putting food inside.
- 2 Increase the temperature after around 70 minutes and continue cooking.
- 3 Turn the food being grilled halfway through the cooking duration.
- 4 Add approx. 0.25 litres of liquid at the start of the cooking programme. Place the meat breast side down in the roasting dish. Turn the meat after 40 minutes and brush it with salted water after 60 minutes.
- 5 Add approx. 0.25 litres of liquid at the start of the cooking programme. Turn the meat after 60 minutes.
- 6 Manually inject 1 burst of steam 5 minutes into the cooking programme.

The charts on the following pages list the Gourmet Assistant applications in your Dialog oven.

Recipes for items listed in the charts are to be found in the cookbook for your Dialog oven.

The cooking function is predefined and cannot be changed. The recommended values for temperature, Gourmet units, intensity and duration can be altered.

If you wish to cook larger or smaller amounts than specified in the recipes, use a correspondingly larger or smaller tray or container, e.g. the round baking tray instead of the universal tray.

Ingredient quantities that differ from those in the recipe are listed accordingly. Otherwise, quantities are as per the recipe.

Gourmet Assistant

Cakes

Tray-baked cake

Butter cake (**recipe:** "Butter cake")

Streusel cake with fruit

Yeast dough (**recipe:** "Streusel cake with fruit (Yeast dough)")

Quark and oil dough (**recipe:** "Streusel cake with fruit (Quark and oil dough)")

Creamed cake

Marble cake (**recipe for all tins:** "Marble cake")

Gugelhupf tin 24 cm (**specified amount of ingredients**)

Rectangular tin 30 cm (**0.7 times the amount of ingredients**)

Ring cake tin 26 cm (**specified amount of ingredients**)

Sponge cake (**recipe for all tins:** "Vanilla sponge cake")

Gugelhupf tin 24 cm

Rectangular tin 30 cm

Ring cake tin 26 cm

Gourmet Assistant
Bread
Focaccia (recipe: "Focaccia")
Round baking tray (0.3 times the amount of ingredients)
Universal tray (specified amount of ingredients)
White bread
On tray (recipe: "White bread, fresh")
800 g (specified amount of ingredients)
1000 g (1.25 times the amount of ingredients)
Rectangular tin 25 cm (recipe: "White herb bread", 0.8 times the amount of ingredients)
Rectangular tin 30 cm (recipe: "White herb bread", specified amount of ingredients)
Wheatgrain bread (recipe: "Mixed grain bread, fresh")
Rectangular tin 25 cm (0.8 times the amount of ingredients)
Rectangular tin 30 cm (specified amount of ingredients)
Rolls
Sweet yeast rolls (recipe: "Raisin rolls")
5 pieces (half the quantity of ingredients)
10 pieces (specified amount of ingredients)
White rolls (recipe: "White rolls, fresh")
4 pieces (half the quantity of ingredients)
8 pieces (specified amount of ingredients)

Gourmet Assistant
Pizza & Quiche
Puff pastry parcels (recipe: "Sausage rolls")
4 pieces (0.7 times the amount of ingredients)
6 pieces (specified amount of ingredients)
8 pieces (1.3 times the amount of ingredients)
Pizza (recipe: "Pizza (Yeast dough)")
Baking tray (specified amount of ingredients)
Round baking tray (half the quantity of ingredients)
Quiche (recipe: "Quiche Lorraine")
Flan (recipe: "Cheese flan")
Baking tray (double the amount of ingredients)
Round baking tray (specified amount of ingredients)
Meat
Poultry
Chicken, whole (recipe: "Chicken")
Roast turkey breast (recipe: "Stuffed turkey breast")
Veal
Fillet of veal (recipe for all degrees of doneness: "Fillet of veal")
Pink / Medium / Well done
Loin of veal (recipe for all degrees of doneness: "Loin of veal")
Pink / Medium / Well done
Beef
Fillet of beef (recipe for all degrees of doneness: "Fillet of beef")
Rare / Medium / Well done
Sirloin joint (recipe for all degrees of doneness: "Sirloin joint")
Rare / Medium / Well done
Pork
Meat loaf (recipe: "Meat loaf")
Gammon joint (recipe: "Gammon joint")
Pork roast (recipe: "Pork roast")
Pork tenderloin
Pink / Medium / Well done

Gourmet Assistant overview

Gourmet Assistant
Fish
Salmon gratin (recipe: “Salmon gratin”)
2 portions (0.3 times the amount of ingredients)
4 portions (0.7 times the amount of ingredients)
6 portions (specified amount of ingredients)
8 portions (1.3 times the amount of ingredients)
Salmon trout, whole (recipe: “Stuffed salmon trout”, without filling)
600–1800 g (adjust amount of ingredients to suit)
Pikeperch fillet (recipe “Zander on a bed of herbs”)
400–1600 g (adjust amount of ingredients to suit)
Seafood
Bearded mussels (recipe: “Thai mussels”)
500–2000 g (adjust amount of ingredients to suit)

Gourmet Assistant

Bakes & gratins

Potato gratin (recipe: "Potato gratin")

2 portions (half the quantity of ingredients)

4 portions (specified amount of ingredients)

6 portions (1.5 times the amount of ingredients)

8 portions (double the amount of ingredients)

Lasagne (recipe: "Lasagne")

2 portions (half the quantity of ingredients)

4 portions (specified amount of ingredients)

6 portions (1.5 times the amount of ingredients)

8 portions (double the amount of ingredients)

Pasta bake (recipe: "Pasta bake")

2 portions (half the quantity of ingredients)

4 portions (specified amount of ingredients)

6 portions (1.5 times the amount of ingredients)

8 portions (double the amount of ingredients)

Vegetables

Ratatouille (recipe: "Ratatouille")

500–3000 g (adjust amount of ingredients to suit)

Root vegetables (recipe "Oriental root vegetables")

500–2500 g (adjust amount of ingredients to suit)

Overview of Automatic programmes Auto

The charts on the following pages list the factory-set Automatic programmes on your Dialog oven.

The recipes for these programmes are in the cookbook for your Dialog oven.

Automatic programmes
M Chef menu
Mince Vegetables Rice
Kebab Cauliflower Focaccia
Salmon Chicken Brioche
Lamb Veg Potatoes
Seafood Salmon Beef
Char Veg Potatoes
Sea bass Chicken
Cakes
Apple sponge
Gateau
Butter cake
Prove dough
Caramel apple cake
Cheesecake
Coconut cake
Almond cake
Marble cake
Vanilla sponge cake
Chocolate nut cake
Streusel cake with fruit
Yeast dough
Quark and oil dough
Tea cake
Cinnamon macadamia ring

Automatic programmes
Cookies/Muffins
Biscuits
Raisin whirls
Chocolate cherry muffins
Drop cookies
Vanilla biscuits
Walnut muffins
Choux buns
Bread
Focaccia
Plaited loaf
Marbled plaited yeast loaf
White herb bread
Tiger bread
White bread, fresh
Granary bread
Mixed grain bread, fresh
Mixed grain bread, frozen
Ginger loaf
Rolls
Croissants
Raisin rolls
Chocolate rolls
White rolls, fresh
White rolls, frozen

Overview of Automatic programmes Auto

Automatic programmes
Pizza & Quiche
Vegetarian flan
Cheese flan
Kohlrabi strudel with lobster
Salmon en croûte
Pizza
Yeast dough
Quark and oil dough
Quiche Lorraine
Spinach in puff pastry
Tomato Ricotta quiche
Savoy cabbage strudel
Sausage rolls
Meat
Poultry
Duck
Chicken
Stuffed turkey breast
Veal
Fillet of veal
Loin of veal
Beef
Fillet of beef
Sirloin joint
Pork
Meat loaf
Gammon joint
Pulled pork
Pork roast
Stuffed fillet of pork
Fillet of pork en crouete

Automatic programmes
Fish
Sea bream with vegetables
Fish in ice
Cod with a herb topping
Confit salmon
Salmon pie
Salmon gratin
Stuffed salmon trout
Sea bass in a salt crust
Zander on a bed of herbs
Seafood
Vegetables and prawns
Confit scallops
Thai mussels
Bakes & gratins
Chicory gratin
Potato gratin
Lasagne
Moussaka
Pasta bake
Paella
Shepherd's pie
Terrine & Co
Meat paté
Chicken and lobster terrine
Salmon terrine

Overview of Automatic programmes Auto

Automatic programmes
Vegetables
Antipasti
Aubergine
White mushrooms
Peppers
Baked cauliflower
Fennel with Prosecco
Mixed vegetables
Ratatouille
Asparagus
Oriental root vegetables
Courgette gratin
Dessert
Pineapple gratin
Baked yeast dumplings
Crème caramel
Crumble
Raspberry soufflé
Pumpkin soufflé
Key lime pie
Chocolate delight

EU Conformity declaration

Miele hereby declares that this oven complies with Directive 2014/53/EU.

The complete text of the EU declaration of conformity is available from one of the following internet addresses:

- Products, Download from www.miele.ie
- For service, information, operating instructions etc: go to www.miele.ie/domestic/customer-information-385.htm and enter the name of the product or the serial number

Frequency range of the WiFi module	2.4000–2.4835 GHz
------------------------------------	-------------------

Maximum transmission power of the WiFi module	< 100 mW
---	----------

UK Conformity declaration

Miele hereby declares that this oven complies with UK Radio Equipment Regulations 2017, as amended.

The complete text of the UK declaration of conformity is available from one of the following internet addresses:

- Products, Download from www.miele.co.uk
- For service, information, operating instructions etc: go to www.miele.co.uk and enter the name of the product or the serial number

Frequency range of the WiFi module	2.4000–2.4835 GHz
------------------------------------	-------------------

Maximum transmission power of the WiFi module	< 100 mW
---	----------

Copyright and licences

Miele uses software to operate and control the appliance.

The copyright authorisation from Miele and other relevant software suppliers (e.g. Adobe) must be respected.

Miele and their suppliers reserve the rights to the software components.

In particular the following are prohibited:

- copying and distribution,
- modifications and derivations,
- decompilation, reverse engineering, disassembling and other such reductions of software.

This product contains Adobe® Flash® Player Software under licence from Adobe Systems Incorporated, Adobe Macromedia Software LLC. Adobe and Flash are registered trademarks of Adobe Systems Incorporated.

Components which fall under GNU General Public Licence and further Open Source licences are integrated into the software.

An overview of the integrated Open Source components and a copy of the current licence can be obtained at <http://www.miele.com/device-software-licences>. You will need to enter the specific product name.

Miele will provide the source code for all components of software licensed under the GNU General Public Licence and comparable Open Source licences.

For source code requests, please email info@miele.com.

United Kingdom

Miele Co. Ltd., Fairacres, Marcham Road, Abingdon, Oxon, OX14 1TW

Tel: 0330 160 6600, Internet: www.miele.co.uk/service, E-mail: info@miele.co.uk

Australia

Miele Australia Pty. Ltd.

ACN 005 635 398

ABN 96 005 635 398

Level 4, 141 Camberwell Road

Hawthorn East, VIC 3123

Tel: 1300 464 353

Internet: www.miele.com.au

China Mainland

Miele Electrical Appliances Co., Ltd.

1-3 Floor, No. 82 Shi Men Yi Road
Jing' an District

200040 Shanghai, PRC

Tel: +86 21 6157 3500

Fax: +86 21 6157 3511

E-mail: info@miele.cn,

Internet: www.miele.cn

Hong Kong, China

Miele (Hong Kong) Ltd.

41/F - 4101, Manhattan Place

23 Wang Tai Road

Kowloon Bay, Hong Kong

Tel: (852) 2610 1025

Fax: (852) 3579 1404

Email:

customerservices@miele.com.hk

Website: www.miele.hk

India

Miele India Pvt. Ltd.

1st Floor, Copia Corporate Suites,
Commercial Plot 9,

Mathura Road, Jasola,

New Delhi - 110025

E-mail: customercare@miele.in

Website: www.miele.in

Ireland

Miele Ireland Ltd.

2024 Bianconi Avenue

Citywest Business Campus

Dublin 24

Tel: (01) 461 07 10

Fax: (01) 461 07 97

E-Mail: info@miele.ie

Internet: www.miele.ie

Malaysia

Miele Sdn Bhd

Suite 12-2, Level 12

Menara Sapura Kencana

Petroleum

Solaris Dutamas No. 1

Jalan Dutamas 1

50480 Kuala Lumpur, Malaysia

Phone: +603-6209-0288

Fax: +603-6205-3768

New Zealand

Miele New Zealand Limited

IRD 98 463 631

8 College Hill

Freemans Bay, Auckland 1011

New Zealand

Tel: 0800 464 353

Internet: www.miele.co.nz

Singapore

Miele Pte. Ltd.

29 Media Circle

#11-04 ALICE@Mediapolis

Singapore 138565

sTel: +65 6735 1191

Fax: +65 6735 1161

E-Mail: info@miele.com.sg

Internet: www.miele.sg

South Africa

Miele (Pty) Ltd.

63 Peter Place

Bryanston 2194

P.O. Box 69434

Bryanston 2021

Tel: (011) 875 9000

Fax: (011) 875 9035

E-mail: info@miele.co.za

Internet: www.miele.co.za

Thailand

Miele Appliances Ltd.

BHIRAJ TOWER at EmQuartier

43rd Floor Unit 4301-4303

689 Sukhumvit Road

North Klongton Sub-District

Vadhana District

Bangkok 10110, Thailand

United Arab Emirates

Miele Appliances Ltd.

Showroom 1

Eiffel 1 Building

Sheikh Zayed Road, Umm Al Sheif

P.O. Box 114782 - Dubai

Tel. +971 4 3044 999

Fax. +971 4 3418 852

800-MIELE (64353)

E-Mail: info@miele.ae

Website: www.miele.ae

Manufacturer: Miele & Cie. KG, Carl-Miele-Straße 29, 33332 Gütersloh, Germany

DO 7860

en-GB

M.-Nr. 11 527 591 / 03