

Panasonic®

LUMIX

S1R

Owner's Manual

Digital Camera

DC-S1R

A firmware update has been made available to improve camera capabilities and to add functionality.

- For information about functions that have been added or modified, refer to the pages for "Firmware Update".



[Click here to move to "Firmware Update".](#)

DVQP1845ZE
F0319MR5110

Please read these instructions carefully before using this product, and save this manual for future use.

**Register online at <http://shop.panasonic.com/support>
(U.S. customers only)**

Dear Customer,

Thank you for choosing Panasonic!

You have purchased one of the most sophisticated and reliable products on the market today. Used properly, we're sure it will bring you and your family years of enjoyment. Please take time to fill in the information below. The serial number is on the tag located on the underside of your camera. Be sure to **retain this manual** as your convenient camera information source.

Date of Purchase	Dealer Phone No.
Dealer Purchased From	Model No.
Dealer Address	Serial No.

Please note that the actual controls and components, menu items, etc. of your Digital Camera may look somewhat different from those shown in the illustrations in this Owner's Manual.

Carefully observe copyright laws.

Recording of pre-recorded tapes or discs or other published or broadcast material for purposes other than your own private use may infringe copyright laws. Even for the purpose of private use, recording of certain material may be restricted.

About Owner's Manual

- This document provides an explanation with the assumption that menu settings are in the default settings.
- Description in this document is based on the interchangeable lens (S-R24105).

❖ Symbols Used in the Text

Symbols for recording modes, pictures, and videos that can be used













In this document, symbols are placed at the start of functional explanations (recording modes, pictures, and videos) showing conditions in which these functions can be used.

Black icons show conditions in which these can be used, and gray icons show conditions in which these cannot be used.

Example:   /  

Operating symbols

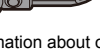
In this document, camera operation is explained using the following symbols:

	(A)		Front dial
	(B)		Rear dial
	(C)		Cursor button up/down/left/right or Joystick up/down/left/right
	(D)		Press the center of the joystick
	(E)		[MENU/SET] button
	(F)		Control dial





- For information about operation methods of the operation part, refer to page 62.
- Other symbols, such as icons shown on the camera screen, are also used in explanations.
- This document describes the procedure for selecting menu items as follows:
Example) Set [Picture Quality] of the [Photo] ([Image Quality]) menu to [STD.].

 →  →  → [Picture Quality] → Select [STD.]

For information about menu operation methods, refer to page 73.

Notification classification symbols

In this document, notifications are classified and described using the following symbols:

	To confirm prior to using the function
	Hints for better use of the camera and tips for recording
	Notifications and supplementary items regarding specifications
	Related information and page number

Chapters

1. Introduction	17
2. Getting Started	31
3. Basic Operations	56
4. Easy Recording	77
5. Image Recording	82
6. Focus/Zoom	91
7. Drive/Shutter	125
8. Metering/Exposure/ISO Sensitivity	178
9. White Balance/Image Quality	194
10. Flash	216
11. Recording Videos	230
12. Playing Back and Editing of Images	259
13. Camera Customization	277
14. Menu Guide	303
15. Wi-Fi/Bluetooth	370
16. Connecting to Other Devices	426
17. Materials	445

Contents

About Owner's Manual	3
Chapters	5
Contents by Function	14

1. Introduction **17**

Before Use	17
Standard Accessories	20
Lenses That Can Be Used	21
Memory Cards That Can Be Used	22
Names of Parts	24
Camera	24
Supplied Lens	28
Displaying Viewfinder/Monitor	29
Status LCD Display	30

2. Getting Started **31**

Attaching a Shoulder Strap	31
Charging the Battery	33
Charging with the Charger	33
Battery Insertion	36
Charging the Battery with the Camera	38
Charging While Using the Camera	40
Notifications Regarding Charging/Power Supply	42
[Power Save Mode]	44
Inserting Cards (Optional)	46
Formatting Cards (Initialization)	48
Attaching a Lens	49
Attaching a Lens Hood	51
Setting the Clock (When Turning On for the First Time)	53

3. Basic Operations 56

Basic Recording Operations	56
How to Hold the Camera	56
Adjusting the Angle of the Monitor	58
Taking Pictures	59
Recording Videos	60
Selecting the Recording Mode	61
Camera Setting Operations	62
Display Settings	66
Setting the Viewfinder	66
Switching Between the Monitor and Viewfinder	67
Switching the Display Information	68
Turning On the Status LCD Backlight	70
Quick Menu	71
Menu Operation Methods	73
[Reset]	76

4. Easy Recording 77

Intelligent Auto Mode	77
Recording Using Touch Functions	80
Touch Shutter	80
Touch AE	81

5. Image Recording 82

[Aspect Ratio]	82
[Picture Size]	83
[Picture Quality]	85
[Double Card Slot Function]	87
[Folder / File Settings]	88
[File Number Reset]	90

6. Focus/Zoom 91

Selecting the Focus Mode	91
Using AF	92
[AF Custom Setting(Photo)]	96
Selecting the AF Mode	98
[Face/Eye/Body/Animal Detect.].....	99
[Tracking].....	102
[225-Area].....	104
[Zone (Vert./ Horz.)]/ [Zone (Square)]/ [Zone (Oval)].....	105
[1-Area+]/ [1-Area].....	107
[Pinpoint]	108
[Custom1] to [Custom3].....	110
AF Area Movement Operation	112
Moving the AF Area by Touch	113
Moving the AF Area Position with the Touch Pad	115
[Focus Switching for Vert / Hor].....	116
Record Using MF	117
Recording Images with Zoom	121
Extended Tele Conversion	122

7. Drive/Shutter 125

Selecting the Drive Mode.....	125
Taking Burst Pictures.....	126
6K/4K Photo Recording	130
Notes on 6K/4K Photos	135
Selecting Pictures from a 6K/4K Burst File	138
Correcting Pictures After Recording (Post-Recording Refinement).....	140
Picture Selection Operations	141
Recording with Time Lapse Shot.....	145
Recording with Stop Motion Animation	148
Time Lapse Shot/Stop Motion Animation Videos	151
Recording Using the Self-timer.....	153
Bracket Recording	155

Post-Focus Recording	161
Selecting the Focus Position for the Picture to Save	164
Focus Stacking	166
[Silent Mode].....	169
[Shutter Type].....	170
Image Stabilizer	172
Image Stabilizer Settings	174

8. Metering/Exposure/ISO Sensitivity **178**

[Metering Mode].....	178
Program AE Mode	179
Aperture-Priority AE Mode.....	181
Shutter-Priority AE Mode	183
Manual Exposure Mode.....	185
Preview Mode	188
Exposure Compensation	189
Locking Focus and Exposure (AF/AE Lock).....	191
Setting the ISO Sensitivity	192

9. White Balance/Image Quality **194**

Setting the White Balance (WB)	194
Adjusting the White Balance	197
[Photo Style]	199
[Filter Settings].....	204
[Simultaneous Record w/o Filter]	209
[High Resolution Mode]	210
[HLG Photo].....	214

10. Flash **216**

Using an External Flash (Optional).....	216
Removing the Hot Shoe Cover	216
Setting Flash Functions	219
[Firing Mode]/[Manual Flash Adjust.]	219
[Flash Mode]	220

[Flash Synchro]	223
Adjusting the Flash Output	224
[Auto Exposure Comp.]	225
[Red-Eye Removal]	225
Recording Using a Wireless Flash	226

11. Recording Videos **230**

Recording Videos	230
Video Settings	233
[Rec. File Format]	233
[Rec Quality]	234
[Image Area of Video]	238
[Continuous AF]	239
[AF Custom Setting(Video)]	240
[Luminance Level]	241
Recording While Controlling Overexposure (Knee)	241
Displaying/Setting the Sound Recording Level	243
Creative Video Mode	244
[CreativeVideo Combined Set.]	246
[High Speed Video]	247
Recording Videos Using a Connected External Device	248
External Monitor/Recorder ([HDMI Rec Output])	248
External Microphones (Optional)	253
XLR Microphone Adaptor (Optional)	256
Headphones	257

12. Playing Back and Editing of Images **259**

Playing Back Pictures	259
Playing Back Videos	261
Extracting a Picture	263
Switching the Display Mode	264
Enlarged Display	264
Thumbnail Screen	266
Calendar Playback	267
Group Images	268

Deleting Images.....	269
[RAW Processing]	271
[Video Divide]	276

13. Camera Customization **277**

Fn Buttons	278
Register Functions to the Fn Buttons.....	279
Use the Fn Buttons	285
Fn Lever	286
Register a Function to the Fn Lever.....	286
Use the Fn Lever	288
[Dial Operation Switch]	289
Register Functions to the Dials	289
Temporarily Change Dial Operation	290
Quick Menu Customization.....	291
Register to the Quick Menu	291
Custom Mode	296
Register in Custom Mode	296
Using Custom Mode	298
Calling Settings.....	299
My Menu.....	300
Registration in My Menu	300
Edit My Menu.....	301
[Save/Restore Camera Setting].....	302

14. Menu Guide **303**

[Photo] Menu	304
[Video] Menu	318
[Custom] Menu	325
[Setup] Menu	349
[Playback] Menu	361
Entering Characters.....	369

15. Wi-Fi/Bluetooth **370**

Wi-Fi/Bluetooth Functions.....	370
Connecting to a Smartphone	372
Installing “LUMIX Sync”	373
Connecting to a Smartphone (Bluetooth Connection).....	374
Connecting to a Smartphone ([Wi-Fi connection]).....	377
Terminating the Wi-Fi Connection.....	382
Operating the Camera with a Smartphone	383
[Remote shooting]	384
[Shutter Remote Control].....	386
Transferring Recorded Images.....	388
Transferring Recorded Images Automatically	390
Recording Location Information	392
Camera Power Operations	393
Automatically Setting the Clock.....	394
Saving Settings Information	395
Sending Images from the Camera.....	396
[Smartphone].....	399
[PC]	402
[Printer].....	405
[Web service].....	407
[Cloud Sync. Service].....	410
Wi-Fi Connections	412
[Via Network]	412
[Direct]	416
Connect to Wi-Fi Using Previously Saved Settings.....	417
Send Settings and Selecting Images.....	419
Image Send Settings	419
Selecting Images.....	420
[Wi-Fi Setup] Menu	421
“LUMIX CLUB”	422

16. Connecting to Other Devices 426

Viewing on a TV	426
Importing Images to a PC.....	430
Installing Software.....	430
Copying Images to a PC	433
Storing on a Recorder	436
Tethered Recording.....	438
Installing Software.....	438
Operating the Camera from a PC	439
Printing	441

17. Materials 445

Using Optional Accessories.....	445
Battery Grip (Optional)	445
Shutter Remote Control (Optional)	446
AC Adaptor (Optional)/DC Coupler (Optional)	447
Monitor/Viewfinder Displays	448
Recording Screen	448
Playback Screen	453
Message Displays	456
Troubleshooting.....	459
Cautions for Use.....	470
Usage Duration, Number of Pictures.....	480
Number of Recordable Pictures, Recordable Time	482
List of Default Settings/Saving Customization/ Copied Settings	485
List of Functions That Can Be Set in Each Recording Mode.....	497
Specifications	502
Index.....	509
Trademarks and Licences	517

Contents by Function

Power Source

Charging	→ 33
Charging error	→ 35
	→ 40
Battery indication	→ 42
Power supply	→ 40
[Battery Information]	→ 356
Power save function	→ 44
Usage duration, Number of pictures	→ 480

Card

Cards that can be used	→ 22
[Card Format]	→ 48
[Double Card Slot Function]	→ 87
[Destination Card Slot]	→ 87
Switching the playback card	→ 260
	→ 266
Folder structure	→ 435
[Folder / File Settings]	→ 88
[File Number Reset]	→ 90
Entering characters	→ 369
Number of recordable pictures, Recordable time	→ 482

Lens

Attaching	→ 49
[Image Stabilizer]	→ 172

Basic Settings

[Language]	→ 359
[Clock Set]	→ 53
[Time Zone]	→ 359
[Beep]	→ 354
[Copyright Information]	→ 350
[Reset]	→ 76

Viewfinder

Diopter adjustment	→ 66
Display magnification	→ 66
Eye sensor	→ 67
[Eye Sensor AF]	→ 332

Display

Recording screen	→ 448
Playback screen	→ 453
Viewfinder	→ 29
Status LCD	→ 30
Control panel	→ 451
Switching display	→ 68
Monitor/viewfinder adjustment	→ 352
Monitor/viewfinder luminance	→ 352
Display speed	→ 351
Level gauge	→ 339
Grid lines	→ 341
[Histogram]	→ 340
[Sheer Overlay]	→ 347
Checking overexposure	→ 346
[HLG View Assist]	→ 347

AF/MF

Focus mode	→ 91
Selecting the AF mode	→ 98
	→ 331
Face/eye/human detection	→ 99
Animal detection	→ 100
Movement tracking	→ 102
[AF ON]	→ 94
Moving the AF area	→ 112
Enlarged display	→ 94
	→ 119
Setting the AF sensitivity	→ 96
AF/AE Lock	→ 191
Touch AF	→ 114
[Touch Pad AF]	→ 115
[AF Assist Light]	→ 309
MF	→ 117
[MF Guide]	→ 330
[MF Assist]	→ 330
[Focus Peaking]	→ 310

Drive		Exposure	
Drive mode	→ 125	[Exposure Comp.]	→ 189
Burst	→ 126	Program Shift	→ 180
[6K/4K PHOTO]	→ 130	Preview mode	→ 188
[Time Lapse Shot]	→ 145	[Metering Mode]	→ 178
Recording with Stop Motion Animation	→ 148	AE Lock	→ 191
[Self Timer]	→ 153	[One Push AE]	→ 283
[Post-Focus]	→ 161	[Touch AE]	→ 81
Image Quality		[Sensitivity]	→ 192
[Picture Size]	→ 83	[Extended ISO]	→ 327
[Picture Quality]	→ 85	Video Recording	
RAW	→ 85	Video recording	→ 230
JPEG	→ 85	Creative Video mode	→ 244
Aspect ratio	→ 82	[Rec. File Format]	→ 233
[White Balance]	→ 194	[AVCHD]	→ 233
[Photo Style]	→ 199	[MP4]	→ 233
[Filter Settings]	→ 204	[Rec Quality]	→ 234
[Color Space]	→ 328	Resolution	→ 234
[6K/4K PHOTO Noise Reduction]	→ 140	Frame rate	→ 234
[Flicker Decrease (Photo)]	→ 315	Bit rate	→ 234
[Long Exposure NR]	→ 306	Angle of view	→ 238
[i.Dynamic Range]	→ 307	Exposure settings	→ 231
[Vignetting Comp.]	→ 308	Setting the AF sensitivity	→ 240
[Diffraction Compensation]	→ 308	[Continuous AF]	→ 239
Taking Pictures		[High Speed Video]	→ 247
Recording mode	→ 61	Luminance level	→ 241
Quick menu	→ 71	Knee	→ 241
Zoom	→ 121	Sound recording	→ 243
[Ex. Tele Conv.]	→ 122	Headphones	→ 257
[Image Stabilizer]	→ 172	[Sound Output]	→ 257
Bracket recording	→ 155	Wind noise reduction	→ 323
Bulb recording	→ 187	Attenuator	→ 243
[High Resolution Mode]	→ 210	[Flicker Decrease (Video)]	→ 320
[Multiple Exposure]	→ 316	HDMI output	→ 248
[HLG Photo]	→ 214	Output bit value (HDMI)	→ 251
[Shutter Type]	→ 170	External microphone	→ 253
[Silent Mode]	→ 169	XLR Microphone Adaptor	→ 256
Remote control recording	→ 446	Remote control recording	→ 446
Screen display	→ 448		

Flash	
External flash	→ 216
[Firing Mode]	→ 219
[Flash Mode]	→ 220
Flash output adjustment	→ 224
[Flash Synchro]	→ 223
[Wireless Flash Setup]	→ 226
Playback	
[Auto Review]	→ 338
Playing back pictures	→ 259
Playing back videos	→ 261
Thumbnail display	→ 266
Calendar display	→ 267
Enlarged display	→ 264
Group images	→ 268
Saving 6K/4K photos	→ 138
Viewing on a TV	→ 426
Deleting	→ 269
Screen display	→ 453
Editing of Images	
[RAW Processing]	→ 271
[Protect]	→ 365
[Rating]	→ 365
[Resize]	→ 366
[Rotate]	→ 366
[Video Divide]	→ 276
[Copy]	→ 367
Customization	
[Custom] menu	→ 325
Function button	→ 278
Function lever	→ 286
Custom recording mode	→ 296
My Menu	→ 300
Quick menu	→ 291
Dial operation	→ 289
Saving camera settings	→ 302
Connecting with Other Devices	
Sending images (PC)	→ 430
Printing	→ 441
Viewing on a TV	→ 426
HDMI output	→ 428
Tethered recording	→ 438
Cable holder	→ 249
Wi-Fi/Bluetooth	
Bluetooth connection	→ 374
[Wi-Fi connection]	→ 377
	→ 412
[Wi-Fi Setup]	→ 421
Smartphone app “LUMIX Sync”	→ 372
[Remote shooting]	→ 384
Location information	→ 392
Sending images	→ 388
([Smartphone])	→ 399
Sending images ([PC])	→ 402
Sending images ([Printer])	→ 405
Sending images ([Web service])	→ 407
Sending images ([Cloud Sync. Service])	→ 410
Saving camera settings	→ 395
“LUMIX CLUB”	→ 422
Software	
“PHOTOfunSTUDIO”	→ 431
“SILKYPIX”	→ 432
“LUMIX Tether”	→ 438
Maintenance	
[Sensor Cleaning]	→ 359
[Pixel Refresh]	→ 359

1. Introduction

Before Use

❖ Firmware of Your Camera/Lens

Firmware updates may be provided in order to improve camera capabilities or to add functionality. For smoother recording, we recommend updating the firmware of the camera/lens to the latest version.

- **For the latest information on the firmware or to download/update the firmware, visit the following support website:**
<https://panasonic.jp/support/global/cs/dsc/>
(English only)
- To check the firmware version of the camera/lens, attach the lens to the camera and select [Firmware Version] in the [Setup] ([Others]) menu. You can also update the firmware in [Firmware Version]. (→ 360)
- This document provides explanations for camera firmware version 1.0.



❖ Handling of the Camera

Do not subject the camera to strong vibration, impacts, or pressure. These may cause a malfunction or damage.

- Do not drop or knock against hard surfaces.
- Do not push hard on the lens section or monitor.

If sand, dust, or liquid gets on the monitor, wipe it off with a dry soft cloth.

- Touch operations may be incorrectly recognized.

When using in low temperatures (–10 °C to 0 °C (14 °F to 32 °F))

- Before use, attach a Panasonic lens with a minimum recommended operating temperature of –10 °C (14 °F).

Do not place a hand inside the camera mount.

This may cause a failure or damage because the sensor is a precision device.

If you shake the camera while turning the camera off, a sensor may operate or a rattling sound may be heard. This is caused by the image stabilizer mechanism in the body. It is not a malfunction.

❖ Splash Resistant

Splash Resistant is a term used to describe an extra level of protection this camera offers against exposure to a minimal amount of moisture, water or dust. Splash Resistant does not guarantee that damage will not occur if this camera is subjected to direct contact with water.

In order to minimize the possibility of damage please be sure the following precautions are taken:

- Splash Resistant works in conjunction with the lenses that were specifically designed to support this feature.
- Securely close the doors, socket caps, contact points cover, etc.
- When the lens or cap is removed or a door is open, do not allow sand, dust, and moisture to enter inside.
- If liquid gets on the camera, wipe it off with a dry soft cloth.

❖ Condensation (When the Lens, the Viewfinder or Monitor is Fogged Up)

- Condensation occurs when there are temperature or humidity differences. Be careful because condensation can lead to stains or mold on the lens, viewfinder, and monitor or cause a failure.
- If condensation occurs, turn off the camera and leave it for approx. 2 hours. The fog will disappear naturally when the temperature of the camera becomes close to the ambient temperature.

❖ Be Sure to Perform Trial Recording in Advance

Perform trial recording in advance of an important event (wedding, etc.) to check that recording can be performed normally.

❖ **No Compensation Regarding Recording**

Please note that compensation cannot be provided in the event that recording could not be performed due to a problem with the camera or a card.

❖ **Be Careful with Regard to Copyrights**

Under copyright law, you may not use the images and audio you have recorded for other than personal enjoyment without the permission of the copyright holder.

Be careful because there are cases where restrictions apply to recording even for the purpose of personal enjoyment.

❖ **Also Read “Cautions for Use” (→ [470](#))**

Standard Accessories

Check that all the accessories are supplied before using the camera.

- The accessories and their shape will differ depending on the country or area where the camera was purchased.

For details on the accessories, refer to "Owner's Manual" (supplied).

- **Digital camera body** is referred to as **camera** in this document.
- **Battery pack** is referred to as **battery pack** or **battery** in this document.
- **Battery charger** is referred to as **battery charger** or **charger** in this document.
- **The memory card is optional.**

Lenses That Can Be Used

The lens mount of this camera is compliant with the L-Mount standard of Leica Camera AG. It can be used with 35 mm full-frame compatible interchangeable lenses and APS-C size interchangeable lenses of this standard.

- In this document, a 35-mm full-frame interchangeable lens compliant with the Leica Camera AG L-Mount standard is referred to as a **full-frame lens**, and an APS-C-size interchangeable lens compliant with this standard is referred to as an **APS-C lens**. When no differentiation is made between full-frame lenses and APS-C lenses, they are both referred to as the **lens**.

❖ Notes on the Use of APS-C Lenses

When APS-C lenses are used, some functions, such as image area, are disabled or operate differently. (→ 82, 83, 130, 161, 170, 204, 210, 214, 238, 316)

- Refer to catalogs/websites for most current information regarding supported lenses.

<https://panasonic.jp/support/global/cs/dsc/>
(English only)



-  The angle of view while recording with an APS-C lens is equivalent to the angle of view of a focal length of 1.5× when converted to the focal length of a 35 mm film camera. (If a 50 mm lens is used, the angle of view will be equivalent to a 75 mm lens.)

Memory Cards That Can Be Used

You can use an XQD memory card and SD memory card with this camera.

- An XQD memory card is referred to as **XQD card** in this document.

SD memory card, SDHC memory card, and SDXC memory card are referred to by the generic name of **SD card**.

When not differentiating between an XQD card and SD card, a card is referred to as simply **card**.

XQD card

XQD memory card (32 GB to 256 GB)

- Operation with Sony XQD G Series/M Series has been verified for this camera.
(As of January 2019)

- AVCHD videos cannot be recorded with an XQD card.

SD card

SD memory card (512 MB to 2 GB)

- The camera supports SDHC/SDXC memory cards compliant with UHS Speed Class 3 of the UHS-I/ UHS-II standard.

SDHC memory card (4 GB to 32 GB)

- The camera supports SDHC/SDXC memory cards compliant with Video Speed Class 90 of the UHS-II standard.



SDXC memory card (48 GB to 128 GB)

- Operation with the Panasonic cards on the left has been verified.

- For the latest information, check the following support website.

<https://panasonic.jp/support/global/cs/dsc/>

(English only)



❖ SD Cards That Can Be Used Stably with This Camera

To ensure the following recording functions can be used stably, use a card of the supported SD Speed Class, UHS Speed Class, and Video Speed Class.

- Speed classes are SD card standards to guarantee the minimum speed necessary for continuous writing.
- When using an XQD card, you will be able to use the functions regardless of the type of card.

Recording function	Speed Class	Example of indication
4K video	UHS Speed Class 3	U3
High Speed Video		
6K/4K Photo	Video Speed Class 30 or higher	V30
Post-Focus		





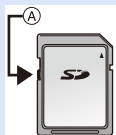

- If you set the write-protect switch (A) of an SD card to "LOCK", you may not be able to write or delete data, format the card, or display the data in recording date and time order.
- The data stored on a card may be damaged due to electromagnetic waves, static electricity or a failure of the camera or card. We recommend backing up important data.
- Keep the memory card out of reach of children to prevent swallowing.

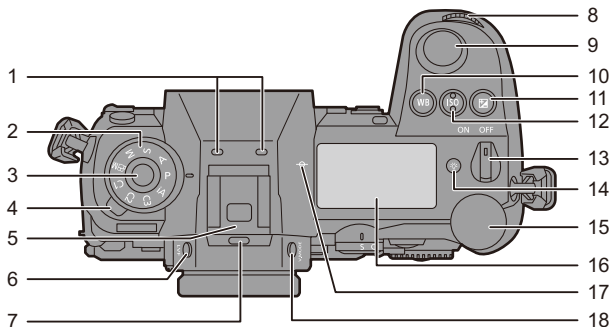

Names of Parts

Camera



1	Stereo microphone (→ 243) • Take care not to block the microphone with a finger. Audio will be difficult to record.	9	Shutter button (→ 59)
2	Mode dial (→ 61)	10	[WB] (White Balance) button (→ 194)
3	Mode dial lock button (→ 61)	11	[] (Exposure compensation) button (→ 189)
4	Drive mode dial (→ 125)	12	[ISO] (ISO sensitivity) button (→ 192)
5	Hot shoe (hot shoe cover) (→ 216) • Keep the hot shoe cover out of reach of children to prevent swallowing.	13	Camera on/off switch (→ 53)
6	[LVF] button (→ 67)	14	[] (Status LCD backlight) button (→ 70, 353)
7	Speaker (→ 354)	15	Rear dial (→ 63)
8	Front dial (→ 63)	16	Status LCD (→ 30, 353)
		17	[] (Recording distance reference mark) (→ 120)
		18	[V.MODE] button (→ 66)

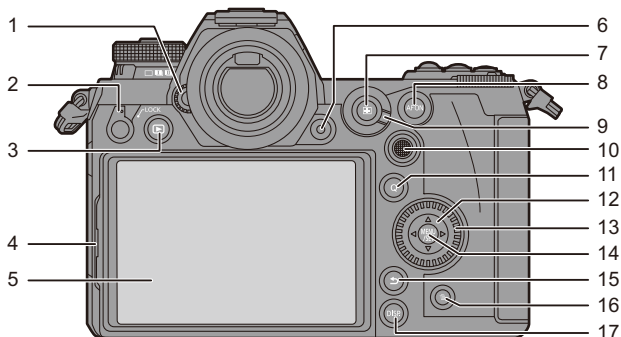

1	Diopter adjustment dial (→ 66)
2	Operation lock lever (→ 65)
3	[▶] (Playback) button (→ 259)
4	Monitor lock lever (→ 58)
5	Monitor (→ 448)/ Touch screen (→ 64)
6	Video rec. button (→ 230)
7	[] (AF mode) button (→ 92)
8	[AF ON] button (→ 94)
9	Focus mode lever (→ 92, 117)
10	Joystick (→ 64)/ Fn buttons (→ 278) Center: Fn8, ▲: Fn9, ►: Fn10, ▼: Fn11, ◀: Fn12

11	[Q] button (→ 71)
12	Cursor buttons (→ 63)/ Fn buttons (→ 278) ▲: Fn13, ►: Fn14, ▼: Fn15, ◀: Fn16
13	Control dial (→ 63)
14	[MENU/SET] button (→ 63, 73)
15	[↵] (Cancel) button (→ 75)
16	[🗑] (Delete) button (→ 269)
17	[DISP.] button (→ 68)



- If you press [⊙], the following buttons light. The lighting timing can be changed in [Illuminated Button] in the [Custom] ([Operation]) menu. (→ 337)
– [▶] button/[Q] button/[↵] button/[🗑] button/[DISP.] button

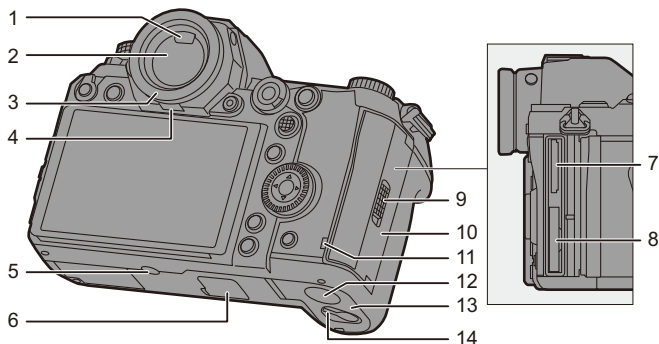

1	Eye sensor (→ 67)
2	Viewfinder (→ 67)
3	Eye cup (→ 473)
4	Eye cup lock lever (→ 473)
5	Tripod mount (→ 478) • If you attempt to attach a tripod with a screw length of 5.5 mm (0.22 inch) or more, you may not be able to securely fix it in place or it may damage the camera.
6	Battery grip connector (cover for the battery grip connector) (→ 445) • Keep the cover for the battery grip connector out of reach of children to prevent swallowing.
7	Card slot 2 (→ 46)
8	Card slot 1 (→ 46)
9	Card door lock lever (→ 46)

10	Card door (→ 46)
11	Card access lamp (→ 47)
12	DC Coupler cover (→ 447) • When using an AC adaptor, ensure that the Panasonic DC Coupler (DMW-DCC16: optional) and AC Adaptor (DMW-AC10: optional) are used.
13	Battery door (→ 36)
14	Battery door release lever (→ 36)

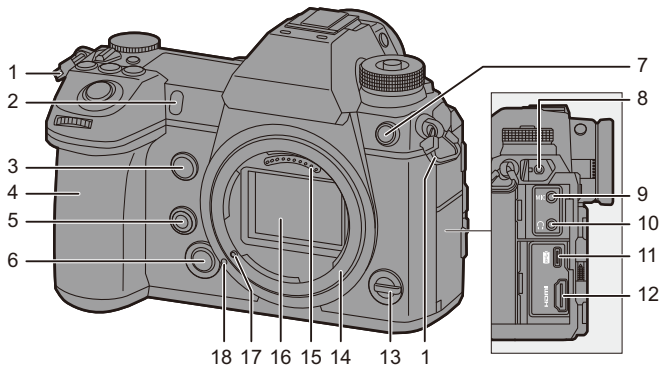

1	Shoulder strap eyelet (→ 31)		
2	Self-timer lamp (→ 153)/ AF assist lamp (→ 309)		
3	Fn button (Fn1) (→ 278)		
4	Grip		
5	Preview button (→ 188)/ Fn button (Fn2) (→ 278)		
6	Lens release button (→ 50)		
7	Flash synchro socket (flash synchro socket cap) (→ 217) • Keep the flash synchro socket cap out of reach of children to prevent swallowing.		
8	[REMOTE] socket (→ 446)		
9	[MIC] socket (→ 253)		
		7	Headphone socket (→ 257) • Excessive sound pressure from earphones and headphones can cause hearing loss.
		8	
		9	
		10	USB port (→ 433, 441)
		11	[HDMI] socket (→ 426)
		12	
		13	Fn lever (→ 286)
		14	Mount
		15	Contact points
		16	Sensor
		17	Lens lock pin
		18	Lens fitting mark (→ 50)

Supplied Lens

S-R24105

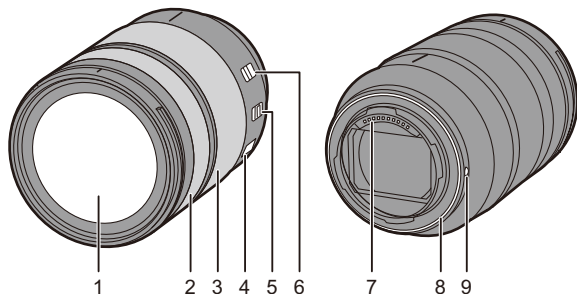

1	Lens surface
2	Focus ring (→ 118)
3	Zoom ring (→ 121)
4	O.I.S. switch (→ 173)
5	[AF/MF] switch (→ 92, 117) <ul style="list-style-type: none"> You can switch between AF and MF. If [MF] is set on either the lens or camera, operation will be with MF.

6	Zoom lock switch <ul style="list-style-type: none"> When you set the focal length to 24 mm and set the switch to [LOCK], the zoom ring is locked.
7	Contact points
8	Lens mount rubber (→ 474)
9	Lens fitting mark (→ 50)

Displaying Viewfinder/Monitor

At the time of purchase, the viewfinder/monitor displays the following icons.

For information about the icons other than those described here, refer to page 448.

Viewfinder

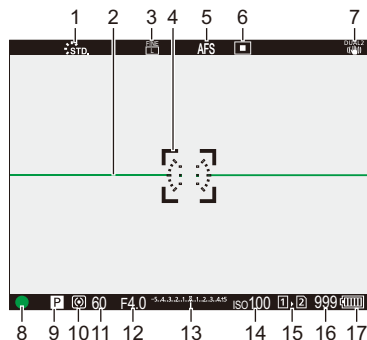

Monitor

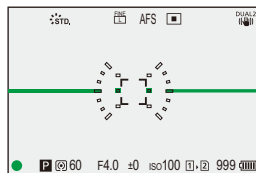

1	Photo Style (→ 199)	11	Shutter speed (→ 59)
2	Level gauge (→ 339)	12	Aperture value (→ 59)
3	Picture quality (→ 85)/ Picture size (→ 83)	13	Exposure compensation value (→ 189)/Manual Exposure Assist (→ 186)
4	AF area (→ 112)	14	ISO sensitivity (→ 192)
5	Focus mode (→ 91, 117)	15	Card slot (→ 46)/Double card slot function (→ 87)
6	AF mode (→ 98)	16	Number of recordable pictures (→ 482)/Number of pictures that can be taken continuously (→ 128)/ Available recording time (→ 483)
7	Stabilizer (→ 172)	17	Battery indication (→ 42)
8	Focus (lit green) (→ 59)/Recording state (lit red) (→ 211, 230)		
9	Recording mode (→ 61)		
10	Metering mode (→ 178)		



- Press [] to switch between display/hide of the level gauge.

Status LCD Display

This displays the recording settings of the camera.

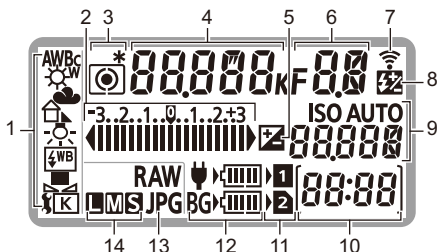

1	White balance (→ 194)	9	ISO sensitivity (→ 192)/ Exposure compensation value (→ 189)
2	Exposure compensation value (→ 189)/ Exposure Bracket (→ 158)	10	Number of recordable pictures (→ 482)/ Number of pictures that can be taken continuously (→ 128)/ Available recording time (→ 483)
3	Metering mode (→ 178)	11	Card slot (→ 46)
4	Shutter speed (→ 59)/ White balance (Color Temperatures) (→ 195)	12	Battery indication (→ 42)/ Power supply indication (→ 40)
5	Exposure compensation (→ 189)	13	Picture quality (→ 85)
6	Aperture value (→ 59)	14	Picture size (→ 83)
7	Wireless (Wi-Fi/Bluetooth) connection state (→ 370)		
8	Flash output adjustment (→ 224)		



- Recording information is not displayed on the status LCD during playback and menu operation.



- Lighting method of the status LCD backlight (→ 70)

2. Getting Started

Attaching a Shoulder Strap

Attach a shoulder strap to the camera with the following procedure to prevent it from dropping.

- 1 Pass the shoulder strap through the shoulder strap eyelet (A).**
- 2 Pass the end of the shoulder strap through the ring and then pass it through the fastener.**
- 3 Pass the end of the shoulder strap through the other hole of the fastener.**
- 4 Pull the shoulder strap and check that it will not come out.**
 - Attach the opposite end of the shoulder strap with the same procedure.

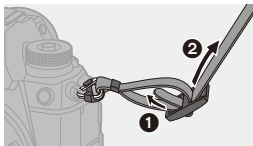
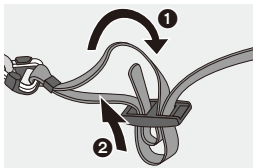
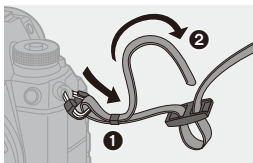
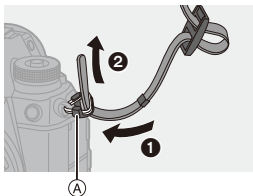



- Use the shoulder strap around your shoulder.
 - Do not wrap the strap around your neck.
It may result in injury or accident.
- Do not leave the shoulder strap where an infant can reach it.
 - It may result in an accident by mistakenly wrapping around the neck.

Charging the Battery

You can charge the battery either using the supplied charger, or in the camera body.

If you turn on the camera, you can also charge the battery while the camera is powered from an electrical outlet.

Instead of using an electrical outlet, you can also connect the camera using a device that supports USB PD (USB Power Delivery).

- The battery that can be used with the camera is DMW-BLJ31. (As of January 2019)



- The battery is not charged at the time of purchase. Charge the battery before use.

Charging with the Charger

Charging time	Approx. 130 min
----------------------	-----------------

- Use the supplied charger and AC adaptor.
- The indicated charging time is for when the battery has been discharged completely. The charging time may vary depending on how the battery has been used. The charging time for the battery in hot/cold environments or a battery that has not been used for a long time may be longer than normal.



- **Use the products supplied with the camera for charging.**
- Use the charger indoors.

1 Connect the charger and the AC adaptor with the USB connection cable (C–C).

- Hold the plugs and insert them straight. (Inserting these at an angle may cause deformation or malfunction)

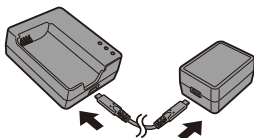

2 Connect the AC cable to the AC adaptor and then insert into the electrical outlet.

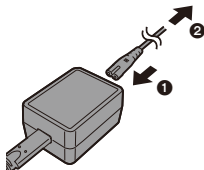

3 Insert the battery.

- Insert the terminal end of the battery and push.
- The [CHARGE] lamp (A) blinks and charging begins.

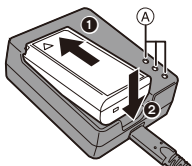

- Do not use any other USB connection cables except the supplied USB connection cable (C–C). This may cause malfunction.
- Do not use any other AC adaptors except the supplied one. This may cause malfunction.
- Do not use any other AC cables except the supplied one. This may cause malfunction.

❖ [CHARGE] Lamp

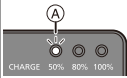
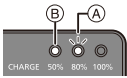
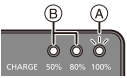
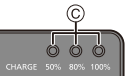
Charging status	0% to 49%	50% to 79%	80% to 99%	100%
[CHARGE] lamp				

Ⓐ Blinking

Ⓑ Lit

Ⓒ Off



- After charging, disconnect the power source connection and remove the battery.
- If the [50%] lamp is blinking quickly, then charging is not occurring.
 - The temperature of the battery or surroundings is either too high or too low. Try charging at an ambient temperature between 10 °C and 30 °C (50 °F and 86 °F).
 - The terminals of the charger or the battery are dirty. Remove the connection to the power source, and wipe with a dry cloth.

Battery Insertion

- Always use genuine Panasonic batteries (DMW-BLJ31).
- If you use other batteries, we cannot guarantee the quality of this product.

1 Turn off the camera.

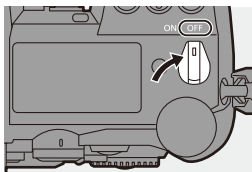

2 Open the battery door.

- Move the battery door release lever to the [OPEN] position.

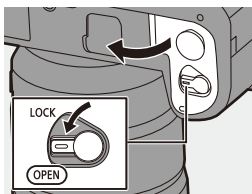

3 Insert the battery.

- Insert the terminal end of the battery and push until a locking sound is heard.
- Check that the lever (A) is holding the battery in place.

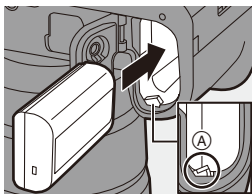

4 Close the battery door.

- Close the battery door, and move the battery door release lever to the [LOCK] position.

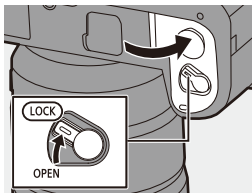

❖ Removing the Battery

- ❶ Turn off the camera.
- ❷ Open the battery door.
 - Check that the card access lamp **(A)** is off and then open the battery door.
- ❸ Push the lever **(B)** in the direction of the arrow and then remove the battery.

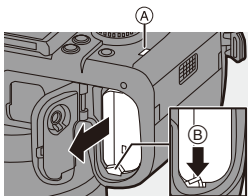

- Ensure that no foreign objects are adhering to the inner side (rubber seal) of the battery door.
- Remove the battery after use.
(The battery will drain if left inserted in the camera for a long period of time.)
- The battery becomes warm after use, during charging, and immediately after charging.
The camera also becomes warm during use. This is not a malfunction.
- Check that the camera is turned off and the card access lamp is off before removing the battery.
(The camera may stop operating correctly or the card and recorded images may be damaged.)
- Be careful when removing the battery as the battery will jump out.

Charging the Battery with the Camera

Charging time	Approx. 140 min
----------------------	-----------------

- Using the camera body and the supplied AC adaptor.
The camera is turned off.
- The indicated charging time is for when the battery has been discharged completely.
The charging time may vary depending on how the battery has been used.
The charging time for the battery in hot/cold environments or a battery that has not been used for a long time may be longer than normal.

- Use the products supplied with the camera for charging.

- 1 Turn off the camera.**
- 2 Insert the battery into the camera.**
- 3 Connect the camera USB port and the AC adaptor using the USB connection cable (C-C).**

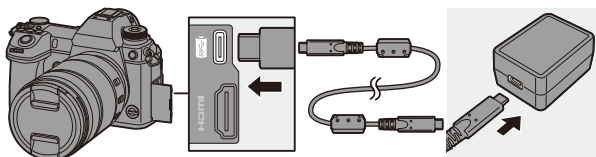

- Hold the plugs and insert them straight.
(Inserting these at an angle may cause deformation or malfunction)

4 Connect the AC cable to the AC adaptor and then insert into the electrical outlet.

- The battery display on the status LCD will blink, and charging starts.

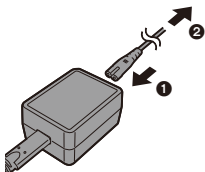

- You can also charge the battery by connecting a USB device (PC, etc.) and the camera with the USB connection cable (C–C or A–C). In that case, charging may take a while.
- When using the Battery Grip (DMW-BGS1: optional), the battery within the Battery Grip will also be charged.



- Do not use any other USB connection cables except the supplied USB connection cables (C–C and A–C). This may cause malfunction.
- Do not use any other AC adaptors except the supplied one. This may cause malfunction.
- Do not use any other AC cables except the supplied one. This may cause malfunction.
- Even when the camera on/off switch is set to [OFF] thus turning the camera off, it consumes power. When the camera will not be used for a long time, remove the power plug from the electrical outlet in order to save power.

❖ Status LCD Display

Charging status	Charging	Charging complete	Charging error
Display	CHARGE	FULL	Err



- After charging, disconnect the connection to the power source.
- When an error is displayed, charging is not possible.
 - The temperature of the battery or surroundings is either too high or too low. Try charging at an ambient temperature between 10 °C and 30 °C (50 °F and 86 °F).

Charging While Using the Camera

When charging with both the camera body and the supplied AC adaptor (→ 38), you can charge while the camera is being supplied with power by turning the camera on. You can record while charging.

This is also possible by connecting devices that support USB PD (USB Power Delivery) to the camera.

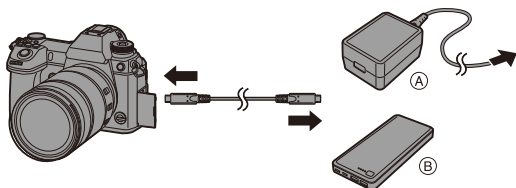

Ⓐ AC adaptor

Ⓑ Devices that support USB PD (mobile battery, etc.)

- Insert the battery into the camera.
- Connect using the supplied USB connection cable (C–C).
- Use a device (mobile battery, etc.) with an output of 9 V/3 A (27 W or more) that supports USB PD.
- When the camera is on, charging will take longer than when the camera is off.



- Even when connecting with devices that support USB PD, you may not be able to charge while using the camera.
- If connecting with devices (PC, etc.) that do not support USB PD and turning the camera on, then this will supply power only.
- If the camera temperature rises under the any of following conditions, charging may stop. If the temperature rises further, [] will be displayed, and power supply will stop.
Wait until the camera cools down.
 - When continuously recording video, etc. while charging/supplying power
 - When the ambient temperature is high
- Turn off the camera before connecting or disconnecting the power plug.
- Remaining charge in the battery may decrease depending on usage conditions. When the battery level is depleted, the camera will turn off.
- Depending on the power supply capabilities of the connected devices, charging may not be possible.

Notifications Regarding Charging/Power Supply

❖ Power Indications

Indication on status LCD

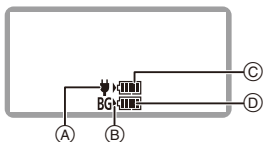

- Ⓐ Receiving power from the USB connection cable
- Ⓑ Power source
- Ⓒ The battery level of the battery in the camera

Indication on monitor

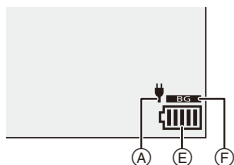

- Ⓓ The battery level of the battery in the Battery Grip
- Ⓔ Battery indication
- Ⓕ Using the battery in the Battery Grip

	80% or higher
	79% to 60%
	59% to 40%
	39% to 20%
	19% or below
 Blinking	Low battery • Charge or replace the battery.





- The battery level indicated on the screen is approximate.
The exact level varies depending on the environment and the operating conditions.
- The highest battery level reading of Ⓒ or Ⓓ blinks during charging.
- When a charging error occurs, the status LCD display icon Ⓐ blinks.



• It has been found that counterfeit battery packs which look very similar to the genuine product are made available for purchase in some markets. Some of these battery packs are not adequately protected with internal protection to meet the requirements of appropriate safety standards. There is a possibility that these battery packs may lead to fire or explosion. Please be advised that we are not liable for any accident or failure occurring as a result of use of a counterfeit battery pack. To ensure that safe products are used, we recommend that a genuine **Panasonic battery pack is used.**



- Do not leave any metal items (such as clips) near the contact areas of the power plug.
Otherwise, a fire and/or electric shocks may be caused by short-circuiting or the resulting heat generated.
- Do not use the AC adaptor, AC cable, or USB connection cables (C–C and A–C) on other devices.
This may cause a malfunction.
- Do not use USB extension cables or USB conversion adaptors.
- The battery can be charged even when it still has some charge left, but it is not recommended that the battery charge be frequently topped up while the battery is fully charged.
(Since characteristic swelling may occur.)
- If there is a power outage or other problem with the electrical outlet, then charging may not complete successfully.
Reconnect the power plug.
- Do not connect to keyboards or printer USB ports, or to USB hubs.
- If the connected PC enters sleep status, then charging/power supply may stop.



- The battery level display on the monitor can be changed to a percentage:
[] ⇒ [] ⇒ [Remaining Battery Level] (→ [352](#))
- You can confirm the degree of deterioration of the battery:
[] ⇒ [] ⇒ [Battery Information] (→ [356](#))

[Power Save Mode]

This is a function to automatically turn the camera to sleep (power save) status or turn off the viewfinder/monitor if no operation is performed for a set time. Reduces battery consumption.

 ⇒ [] ⇒ [] ⇒ Select [Power Save Mode]

[Sleep Mode]	Sets the amount of time until the camera is put into sleep.	
[Sleep Mode(Wi-Fi)]	Sets the camera to sleep 15 minutes after being disconnected from Wi-Fi.	
[Auto LVF/Monitor Off]	Sets the amount of time it takes for the viewfinder/monitor to turn off. (The camera is not turned off.)	
[Power Save LVF Shooting]	Puts the camera into sleep when the recording screen is displayed using automatic viewfinder/monitor switching. • [Power Save LVF Shooting] does not work when [Time to Sleep] is set to [OFF].	
	[Time to Sleep]	Sets the amount of time until the camera is put into sleep.
	[Method of Activation]	Sets the screen where the camera is put to sleep. [Only Control Panel]: Puts the camera into sleep only when the control panel (→ 68) is displayed. [While Recording Standby]: Puts the camera into sleep from any screen during recording standby.

- To recover from [Sleep Mode], [Sleep Mode(Wi-Fi)], or [Power Save LVF Shooting], perform one of the following operations:
 - Press the shutter button halfway.
 - Set the camera on/off switch to [OFF] and then [ON] again.
- To recover from [Auto LVF/Monitor Off], press one of the buttons.



- [Power Save Mode] does not work during the following operations:
 - PC or printer connection
 - Video recording/video playback
 - [6K/4K Pre-Burst] recording
 - [Time Lapse Shot]
 - [Stop Motion Animation] (when [Auto Shooting] is set)
 - [Multiple Exposure] recording
 - During HDMI output for recording
- The settings will be as follows when using the AC Adaptor (DMW-AC10: optional):
 - [Sleep Mode], [Sleep Mode(Wi-Fi)], and [Power Save LVF Shooting]: Disabled
 - [Auto LVF/Monitor Off]: [5MIN.]

Inserting Cards (Optional)

You can use an XQD card and SD card with this camera. (→ 22)

1 Open the card door.

- Slide the card door in the direction of the arrow while pushing down the card door lock lever.

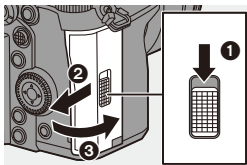

2 Insert the cards.

- (A) Card slot 1: XQD card
- (B) Card slot 2: SD card
- Match the orientation of the cards as shown in the figure and then insert them firmly until they click.
- Do not touch the SD card connection contacts (C).

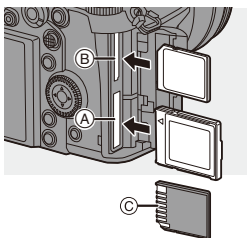

3 Close the card door.

- Close the card door and slide it firmly in the direction of the arrow until it clicks.
- The cards are displayed on the status LCD.

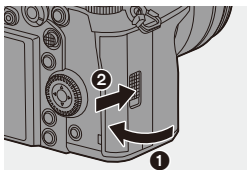

- You can set the way to record to card slots 1 and 2.
[] → [] → [Double Card Slot Function] (→ 87)

❖ Card Access Indications

The card access lamp lights while the card is being accessed.

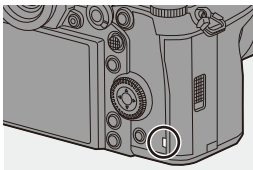

❖ Removing a Card

- 1 Open the card door.
 - Check that the card access lamp (A) is off and then open the card door.
- 2 Push the card until it clicks and then pull the card out straight.

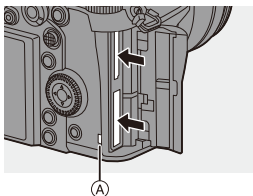

- The card may be hot just after the camera has been used. Be careful when removing.
- **Do not perform the following operations during access. The camera may operate incorrectly or the card and recorded images may be damaged.**
 - Turn off the camera.
 - Remove the battery or card or disconnect the power plug.
 - Subject the camera to vibration, impacts, or static electricity.

Formatting Cards (Initialization)

Format the cards with the camera before use in order to ensure optimal card performance.



- **When a card is formatted, all of the data stored in the card is erased and cannot be restored.**

Save a backup of necessary data before formatting the card.



⇒ [] ⇒ [] ⇒ Select [Card Format]

Settings: [Card Slot 1(XQD)]/[Card Slot 2(SD)]



- Do not turn off the camera or perform another operation during formatting.
- Take care not to turn off the camera while formatting is in progress.
- Cards that have not been formatted after purchase should be formatted on the camera.
- If the card has been formatted with a PC or other device, format it again with the camera.

Attaching a Lens

You can attach the Leica Camera AG L-Mount standard lens to this camera.

For information about the lens that can be used, refer to page 21.

- Change the lens in a location where there is not a lot of dirt and dust. If dirt or dust gets on the lens, refer to page 472.
- Change the lens while the lens cap is attached.

- 1 Turn off the camera.**
- 2 Turn the lens rear cap and the body cap in the direction of the arrow to remove them.**
 - When removing the body cap, rotate it while pressing the lens release button (A).

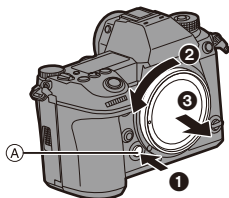
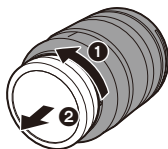

3 Align the lens fitting marks (B) on the lens and camera and then rotate the lens in the direction of the arrow.

- Attach the lens by rotating it until it clicks.

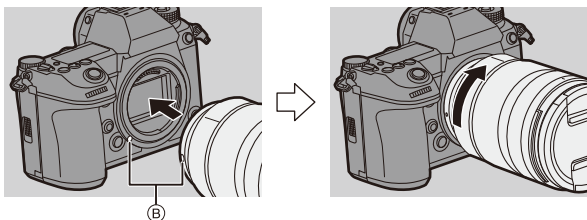

- Insert the lens straight in.
Inserting this at an angle to attach it may damage the camera lens mount.

❖ Removing a Lens

- 1 Turn off the camera.
- 2 While pressing the lens release button (A), rotate the lens in the direction of the arrow until it stops and then remove it.

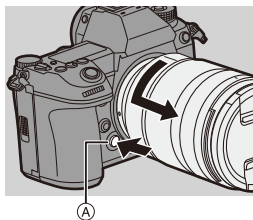

- After removing the lens, be sure to attach the body cap and the lens rear cap.

Attaching a Lens Hood

For recording against strong backlight, a lens hood can reduce the inclusion of unwanted light in images and drop in contrast resulting from the irregular reflection of light that occurs within the lens.

It allows you take more beautiful pictures by cutting out excess light.

When attaching the lens hood (flower shape) supplied with the interchangeable lens (S-R24105)

Hold the lens hood by placing your fingers as shown in the figure.

- Do not hold the lens hood in such a way that it will become bent.

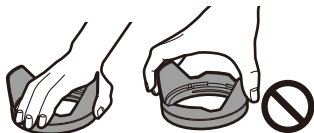

- 1** Align mark **(A)** (□) on the lens hood with the mark on the tip of the lens.

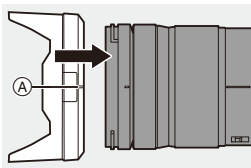

- 2** Rotate the lens hood in the direction of the arrow to align mark **(B)** (○) on the lens hood with the mark on the tip of the lens.

- Attach the lens hood by rotating it until it clicks.

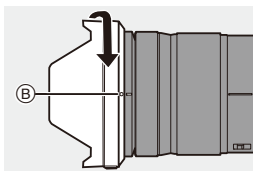

❖ Removing the Lens Hood

While pressing the lens hood button, rotate the lens hood in the direction of the arrow and then remove it.

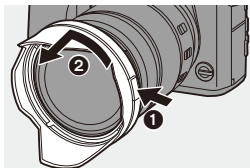

• The lens hood can be attached in the reverse direction when carrying the camera.

- 1 Remove the lens hood.
- 2 Align mark © (○) on the lens hood with the mark on the tip of the lens.
- 3 Attach the lens hood by rotating it in the direction of the arrow until it clicks.

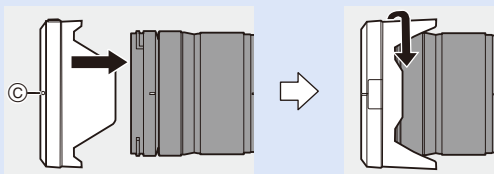

Setting the Clock (When Turning On for the First Time)

When you turn the camera on for the first time, a screen to set the time zone and clock appears.

Be sure to set these settings before use to ensure images are recorded with the correct date and time information.



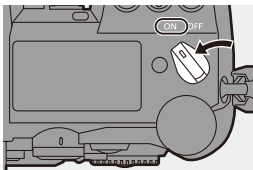

1 Set the camera on/off switch to [ON].

- If the language select screen is not displayed, proceed to Step 4.









2 When [Please set the language] appears, press or .

3 Set the language.

- Press   to select the language and then press  or .

4 When [Please set the time zone] appears, press or .

5 Set the time zone.

- Press   to select the time zone and then press  or .
- If you are using Daylight Savings , press . (The time will move forward by 1 hour.)
To return to the normal time, press  again.



- (A) Time difference from GMT (Greenwich Mean Time)



6 When [Please set the clock] appears, press  or .

7 Set the clock.

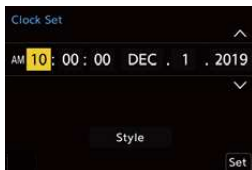
- ◀▶: Select an item (year, month, day, hour, minute, or second).
- ▲▼: Select a value.



To set the display order  and time display format 

- If you select [Style] and then press  or , the screen for setting the display order and time display format appears.

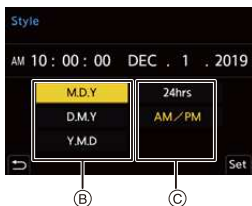

8 Confirm your selection.

- Press  or .

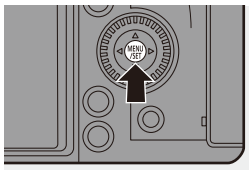



9 When [The clock setting has been completed.] appears, press  or .



- If the camera is used without setting the clock, it will be set to 0:00:00, January 1st 2019.
- Clock settings are maintained for approx. 3 months using the built-in clock battery even without the battery.
(Leave the fully-charged battery in the camera for approx. 24 hours to charge the built-in battery.)



- [Time Zone] and [Clock Set] can be changed from the menu:

–  ⇒ [] ⇒ [] ⇒ [Time Zone] (→ [359](#))

–  ⇒ [] ⇒ [] ⇒ [Clock Set]

3. Basic Operations

Basic Recording Operations

How to Hold the Camera

To minimize camera shake, hold the camera so that it will not move during recording.

Hold the camera with both hands, keep your arms still at your side, and stand with your feet shoulder width apart.

- Hold the camera firmly by wrapping your right hand around the camera grip.
- Support the lens from below with your left hand.
- Do not cover the AF assist lamp (A) or microphone (B) with your fingers or other objects.

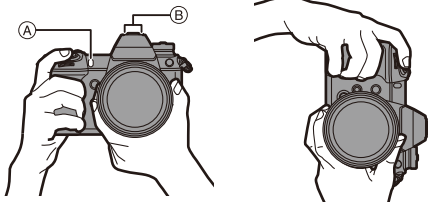

❖ Vertical Orientation Detection Function

This function detects when pictures were recorded with the camera held vertically orientated.

With the default settings, pictures are automatically played back vertically oriented.



- If you set [Rotate Disp.] to [OFF], pictures will be played back without being rotated. (→ 363)



- When the camera is tilted significantly up or down, the vertical orientation detection function may not work correctly.
- Images recorded using the following functions cannot be displayed vertically orientated:
 - Video recording/[6K/4K PHOTO]/[Post-Focus]

Adjusting the Angle of the Monitor

This camera has a 3-axis tiltable monitor.

Adjust the angle of the monitor to match the recording conditions.

This is useful for high and low angle recording.

- High angle recording (horizontal position)

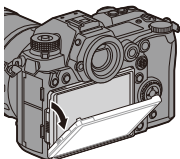

- Low angle recording (horizontal position)

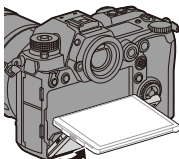

- High angle recording/Low angle recording (vertical position)

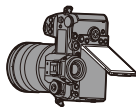
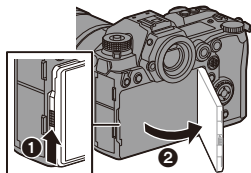

- Open the monitor while pushing up on the monitor lock lever.



- Take care not to trap a finger in the monitor.
- Do not apply an excessive force to the monitor. This may cause damage or malfunction.
- When you will not use the camera, fully close the monitor by returning it to its original position.
- When attaching to a tripod, close the monitor by returning it to its original position.
- The opening angle of the monitor may be limited by the tripod used.

Taking Pictures

1 Adjust the focus.

- Press the shutter button halfway (press it gently).
- The aperture value (A) and shutter speed (B) are displayed.
(When the correct exposure cannot be obtained, the indications blink in red.)
- Once the subject is in focus, the focus indication (C) lights.
(When the subject is not in focus, the indication blinks.)
- You can also perform the same operation by pressing [AF ON].

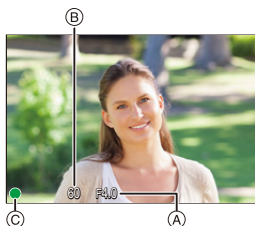
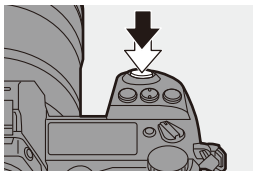

2 Start recording.

- Press the shutter button fully (press it further).

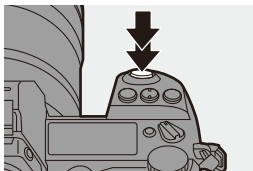



- Recorded pictures can be displayed automatically by setting [Auto Review] of the [Custom] ([Monitor / Display]) menu. You can also change the picture display duration to your preferred setting. (→ 338)



- With the default settings, you cannot take a picture until the subject is brought into focus.
If you set [Focus/Shutter Priority] in the [Custom] ([Focus/Shutter]) menu to [BALANCE] or [RELEASE], you will be able to take a picture even when the subject is not in focus. (→ 329)

Recording Videos

1 Start recording.

- Press the video rec. button.
- Release the video rec. button right after you press it.

2 Stop recording.

- Press the video rec. button again.

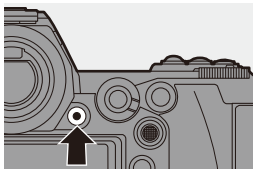

Selecting the Recording Mode

While pressing the mode dial lock button (❶), rotate the mode dial (❷).

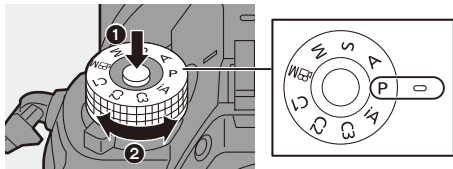

iA	Intelligent Auto mode (→ 77)
P	Program AE mode (→ 179)
A	Aperture-Priority AE mode (→ 181)
S	Shutter-Priority AE mode (→ 183)
M	Manual Exposure mode (→ 185)
 M	Creative Video mode (→ 244)
C1/C2/C3	Custom mode (→ 296)

Camera Setting Operations

When changing the camera settings, operate the camera using the following operation parts.

To prevent accidental operation, you can disable operation with the operation lock lever.

1	Front dial (→ 63)
2	Rear dial (→ 63)
3	Control dial (→ 63)
4	Cursor buttons (→ 63)
5	[MENU/SET] button (→ 63)
6	Joystick (→ 64)
7	Touch screen (→ 64)
8	Operation lock lever (→ 65)

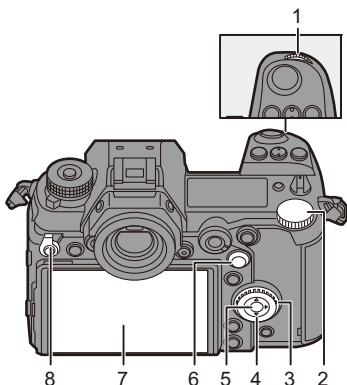

❖ Front Dial ()/Rear Dial ()

Rotate:

Selects an item or numeric value.

- Sets the aperture, shutter speed, and other settings when you are recording in the P/A/S/M modes.

The operation method can be changed in [Dial Set.]. (→ [336](#))

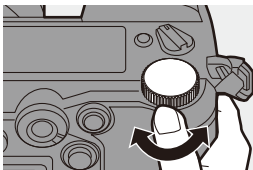
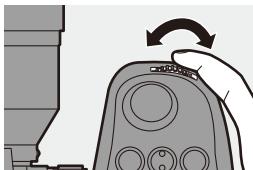

❖ Control Dial ()

Rotate:

Selects an item or numeric value.

- Adjusts the headphone volume during recording. The function can be changed in [Control Dial Assignment] of [Dial Set.]. (→ [336](#))

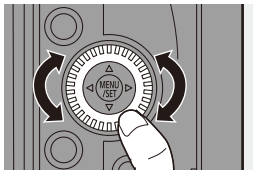

❖ Cursor Buttons ()

Press:

Selects an item or numeric value.

❖ [MENU/SET] Button ()

Press:

Confirms a setting.

- Displays the menu during recording and playback.

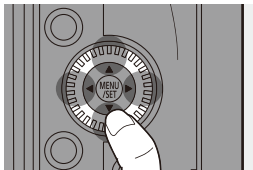

❖ Joystick (▲▼◀▶/⊙)

The joystick can be operated in 8 directions by tilting it up, down, left, right and diagonally and by pressing the center part.

Ⓐ **Tilt:** Selects an item or numeric value, or moves a position.

- Place your finger on the center of the joystick before tilting. The joystick may not work as expected when the sides are pressed.

Ⓑ **Press:** Confirms a setting.

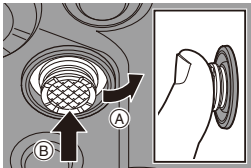

- When recording, this moves the AF area and MF Assist.

The joystick functions for recording can be changed in [Joystick Setting]. (→ 337)

❖ Touch Screen

Operations can be performed by touching the icons, slide bars, menus, and other items displayed on the screen.

Ⓐ **Touch**

Operation of touching and then lifting your finger from the touch screen.

Ⓑ **Drag**

Operation of moving a finger while it touches the touch screen.

Ⓒ **Pinch (widen/narrow)**

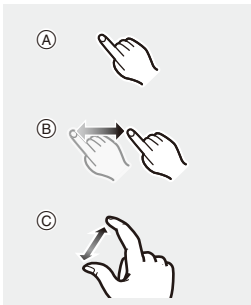

Operations of widening the distance between two fingers (pinch out) and narrowing the distance between two fingers (pinch in) while they are touching the touch screen.





- Touch the screen with clean and dry fingers.
- If you will use a commercially available monitor protection sheet, observe the precautions for the sheet.
(Visibility and operability may be impaired depending on the type of monitor protection sheet.)
- The touch screen may not operate correctly in the following cases:
 - When you are wearing gloves
 - When the touch screen is wet



- Touch operations can be disabled:
[] ⇒ [] ⇒ [Touch Settings] (→ 333)

❖ Operation Lock Lever

Aligning the operation lock lever with the [LOCK] position disables the following operation parts.

The operation parts to disable can be set in [Lock Lever Setting] of the [Custom] ([Operation]) menu. (→ 334)

- Cursor buttons
- [MENU/SET] button
- Joystick
- Touch screen
- Front dial
- Rear dial
- Control dial
- [DISP.] button

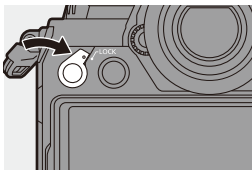

Display Settings

Setting the Viewfinder

❖ Adjusting the Viewfinder Diopter

Rotate the diopter adjustment dial while looking through the viewfinder.

- Adjust the diopter until you can see the characters clearly.

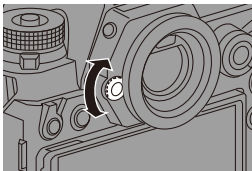

❖ Switching the Viewfinder Display Magnification

Press [V.MODE].

- The display magnification of the viewfinder can be switched between 3 levels.

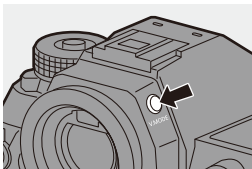

Switching Between the Monitor and Viewfinder

With the default settings, automatic viewfinder/monitor switching is set. When you look through the viewfinder, the eye sensor works and the camera switches from monitor display to viewfinder display. You can switch to viewfinder display or monitor display with [LVF].

Press [LVF] (A).

(B) Eye sensor

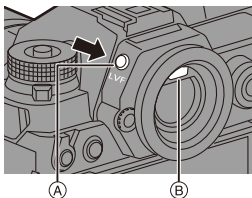





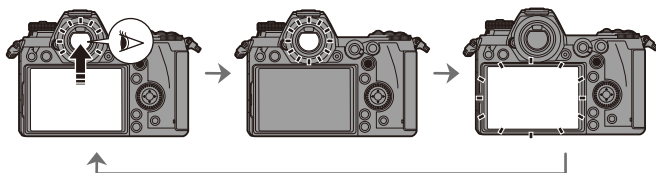

Automatic viewfinder/
monitor switching

Viewfinder display

Monitor display



-  • The eye sensor may not work correctly due to the shape of eyeglasses, the way the camera is held, or bright light shining around the eyepiece.
- The camera does not switch between the viewfinder and monitor automatically during video playback.
- When the monitor is open, the eye sensor does not work.

-  • To focus when looking through the viewfinder:
[] → [] → [Eye Sensor AF] (→ 332)
- The sensitivity of the eye sensor can be changed:
[] → [] → [Eye Sensor] (→ 353)

Switching the Display Information

The recording information (icons) on the recording screen and playback screen can be hidden.

The monitor on the rear of the camera can be set to display only recording information or turned off.

Press [DISP.].

- The display information is switched.

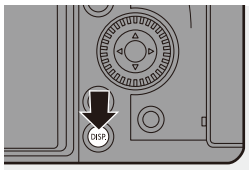

❖ Recording Screen

Monitor

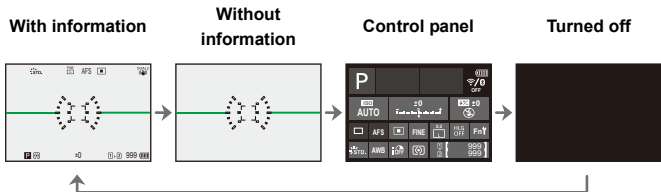

Viewfinder

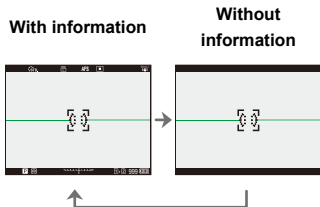













- Press [] to switch between display/hide of the level gauge.
This can also be set by using [Level Gauge]. (→ 339)

Control panel operation

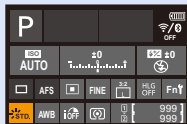
You can touch items on the control panel to directly change their settings. These can also be changed with the following operations:

- 1 Press one of the cursor buttons to enable selection of items.
 - Selected items are displayed in yellow.
- 2 Rotate  or  to select an item.
 - You can also select by pressing    .
- 3 Rotate  to change the settings values.



- The types of screen to display on the monitor can be restricted:
[] → [] → [Show/Hide Monitor Layout] (→ 345)
- The display can be changed so that live view and display information do not overlap:
[] → [] → [LVF/Monitor Disp. Set] (→ 343)

❖ Playback Screen

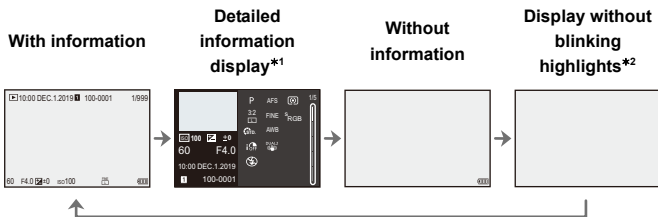

*1 Pressing   switches the display information.

- Detailed information display
- Histogram display
- Photo Style display
- White balance display
- Lens information display

*2 This is a screen without blinking highlights display that is shown when [Blinking Highlights] of the [Custom] ([Monitor / Display]) is set to [ON].



In other than this screen, overexposed parts of the screen will blink. (→ 345)

Turning On the Status LCD Backlight

Press [:◑:].

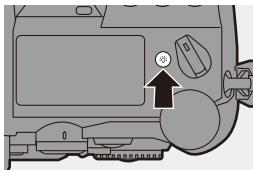
- The backlight will turn on.
- If the camera is left without any operations for approx. 5 seconds, the backlight turns off.
- With the default settings, the illumination button will also light.
- If you press [:◑:] again or fully press the shutter button, the backlight turns off.
- The status LCD backlight and illumination button do not light while you are using the following functions:
 - Video recording/[6K/4K PHOTO]/[Post-Focus]
 - Burst recording
 - Playback
 - Menu
 - Quick menu



- ➔ • The lighting method of the status LCD backlight can be changed:
[] ➔ [] ➔ [Status-LCD] (➔ [353](#))

Quick Menu

This menu enables you to quickly set functions that are frequently used during recording without calling the menu screen. You can also change the Quick menu display method and the items to display.

1 Display the Quick menu.

- Press [Q].

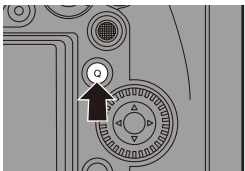

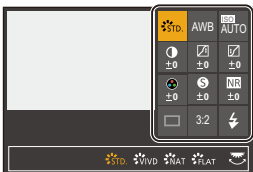

2 Select a menu item.

- Press ▲▼◀▶.
- Directions on the diagonal can also be selected using the joystick.
- Selection is also possible by rotating .
- Selection is also possible by touching a menu item.



3 Select a setting item.

- Rotate  or .
- Selection is also possible by touching a setting item.

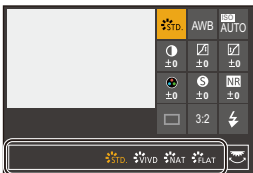

4 Close the Quick menu.

- Press the shutter button halfway.
- You can also close the menu by pressing [Q].

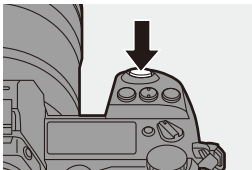



- Some items cannot be set depending on the recording mode or camera settings.



- The Quick menu can be customized:

[] ⇒ [] ⇒ [Q.MENU Settings] (→ [291](#))

Menu Operation Methods

In this camera, the menu is used for setting a wide variety of functions and performing camera customizations.

Menu operation is possible in a variety of ways including using the cursors, joystick, dials, and touch.

Configuration and operation parts of the menu

The menu can be operated by pressing ◀▶ to move between menu screens.

Use the operation parts indicated below to operate the main tab, the sub tab, and menu items without moving to the corresponding menu levels.

- You can also operate the menu by touching the icons on the main tab and the sub tab, menu items and setting items.

- Ⓐ Main tab ([Q] button)
- Ⓑ Sub tab (☀)
- Ⓒ Menu item (☀)
- Ⓓ Setting item

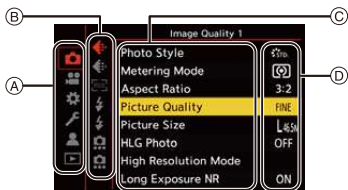

1 Display the menu.

- Press .

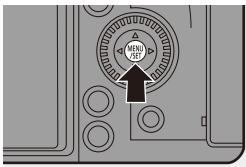



2 Select a main tab.

- Press ▲▼ to select a main tab and then press ▶.
- You can also perform the same operation by rotating to select the main tab and then pressing or .





3 Select a sub tab.

- Press ▲▼ to select a sub tab and then press ►.
- You can also perform the same operation by rotating  to select the sub tab and then pressing  or .







4 Select a menu item.

- Press ▲▼ to select a menu item and then press ►.
- You can also perform the same operation by rotating  to select the menu item and then pressing  or .



5 Select a setting item and then confirm your selection.

- Press ▲▼ to select a setting item and then press  or .
- You can also perform the same operation by rotating  to select the setting item and then pressing  or .
- The display and selection methods differ depending on the setting item.



6 Close the menu.

- Press the shutter button halfway.
- You can also close the menu by pressing [DISP.] several times.



➔ • For details about menu items, refer to Menu Guide. (➔ 303)

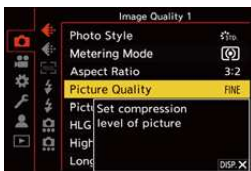

❖ Displaying Descriptions About Menu Items and Settings

If you press [DISP.] while a menu item or setting item is selected, a description about the item is displayed on the screen.



❖ Grayed Out Menu Items

Menu items that cannot be set are displayed grayed out.

If you press  or  while a grayed out menu item is selected, the reason why it cannot be set is displayed.

- The reason why a menu item cannot be set may not be displayed depending on the menu item.

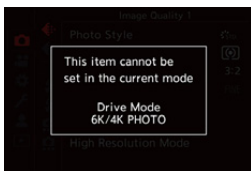

[Reset]

Return each of the following settings to the default setting:

- Recording settings
- Network settings (settings of [Wi-Fi Setup] and [Bluetooth])
- Setup and custom settings (other than [Wi-Fi Setup] and [Bluetooth])

 ⇒ [] ⇒ [] ⇒ Select [Reset]



- If you reset the setup and custom settings, the following settings will also be reset:
 - Settings of [Rotate Disp.], [Picture Sort], [Magnify from AF Point], [HLG View Assist (Monitor)], and [Delete Confirmation] in the [Playback] menu
- The folder numbers and clock settings are not reset.



- List of default settings (→ [485](#))

4. Easy Recording

Intelligent Auto Mode

iA P A S M



The [iA] mode (Intelligent Auto mode) can record images using settings automatically selected by the camera.

The camera detects the scene to set the optimal recording settings automatically to match the subject and recording conditions.

1 Set the mode dial to [iA].

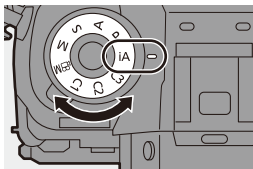

2 Aim the camera at the subject.

- When the camera detects the scene, the recording mode icon changes.

(Automatic Scene Detection)



3 Adjust the focus.

- Press the shutter button halfway.
 - Once the subject is in focus, the focus indication lights.
- (When the subject is not in focus, the indication blinks.)

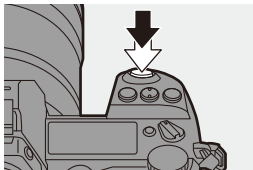

- [AF-ON] of the AF mode works and the AF area is displayed aligned to any humans or animals.

4 Start recording.

- Press the shutter button fully.

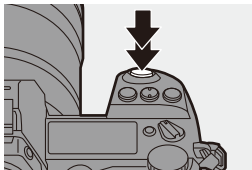

- Backlight compensation operates automatically to prevent subjects from appearing dark when there is a backlight.

❖ Types of Automatic Scene Detection

: Scenes detected during picture taking

: Scenes detected during video recording



:
i-Portrait & Animal



:
i-Portrait*¹



:
i-Scenery



:
i-Macro



:
i-Night Portrait*²



:
i-Night Scenery



:
i-Food



:
i-Sunset



:
i-Low Light



:
iA

*¹ Detected when animal detection is disabled.

*² Detected when using an external flash.







- If none of the scenes are applicable, recording is with [iA] (standard setting).
- Different scene types may be selected for the same subject depending on the recording conditions.

❖ AF Mode

Changing the AF mode.

- Each press of [] changes the AF mode.

 <p>([Face/Eye/Body/Animal Detect.])</p>	<p>The camera detects a person's face, eyes, and body (entire body or upper half of the body) and the body of animals, and adjusts the focus.</p> <ul style="list-style-type: none"> • Each press of  switches the person, animal or eye to be brought into focus. It cannot be switched by touching. • Animal detection will maintain the enable/disable setting selected during other than [iA] mode. 	
 <p>([Tracking])</p>	<p>When the focus mode is set to [AFC], the AF area follows the movement of the subject, maintaining focusing.</p> <p>Aim the AF area over the subject and then press and hold the shutter button halfway.</p> <ul style="list-style-type: none"> • The camera will track the subject while the shutter button is pressed halfway or fully. 	



- For information about AF modes, refer to page 99 and 102.

❖ Flash

When recording using a flash, the camera switches to the appropriate flash mode for the recording conditions.

When Slow Sync. ([iS], [iS^s]), be careful with regard to camera shake because the shutter speed becomes slow.



- When [iS] or [iS^s], Red-Eye Removal works.



- For information about external flashes, refer to page 216.

Recording Using Touch Functions

Touch Shutter



This function focuses on a touched position and then releases the shutter.

- With the default settings, the Touch Tab is not displayed. Set [Touch Tab] to [ON] in [Touch Settings]. (→ 333)

1 Touch [**<**].

2 Touch [**☞**].

- The icon changes to [**☞**] indicating that you can start Touch Shutter recording.



3 Touch the subject you wish to focus on.

- The AF operates and the image will be recorded.



❖ How to Disable Touch Shutter

Touch [**☞**].

- The icon changes to [**☞**].

- If focus adjustment failed, the AF area will be lit red.

Touch AE



This function adjusts the brightness according to a touched position. When a subject's face appears dark, you can make the screen brighter to match the face.

- With the default settings, the Touch Tab is not displayed. Set [Touch Tab] to [ON] in [Touch Settings]. (→ 333)

1 Touch [].

2 Touch [].

- The Touch AE settings screen appears.



3 Touch the subject to which you wish to adjust the brightness.

- To return the position to which to adjust the brightness to the center, touch [Reset].



4 Touch [Set].

❖ How to Disable Touch AE

Touch [].

- You can also adjust both the focus and brightness to those of the position you touch. (At this time, Touch AE is not available):
[] ⇒ [] ⇒ [Touch Settings] ⇒ [Touch AF] ⇒ [AF+AE] (→ 113)

5. Image Recording

[Aspect Ratio]

iA P A S M 



You can select the image aspect ratio.



 → [] → [] → Select [Aspect Ratio]

[4:3]	Aspect ratio of a 4:3 monitor
[3:2]	Aspect ratio of a standard film camera
[16:9]	Aspect ratio of a 16:9 TV
[1:1]	Square aspect ratio
[65:24]	Panoramic aspect ratio
[2:1]	



- [16:9] and [1:1] aspect ratios are not available when using the following functions:
 - 6K photo
 - [Post-Focus] (when set to [6K 18M])
- [65:24] and [2:1] aspect ratios are not available when using the following functions:
 - [iA] mode
 - Taking burst pictures
 - [6K/4K PHOTO]/[Post-Focus]
 - [Time Lapse Shot]
 - [Stop Motion Animation]
 - [HLG Photo]
 - [High Resolution Mode]
 - [Filter Settings]
 - [Multiple Exposure]
- When using APS-C lenses, [65:24]/[2:1] are not available.



- You can register functions to Fn buttons:
[] → [] → [Fn Button Set] → [Setting in REC mode] → [Aspect Ratio]
(→ 278)

[Picture Size]

iA P A S M 



Sets the picture's image size. The image size varies depending on the [Aspect Ratio] or the lens used.

When an APS-C lens is used, the image area switches to the one for APS-C, thereby narrowing the angle of view.

 →  →  → Select [Picture Size]

[Aspect Ratio]	Picture size			
	When using full-frame lenses		When using APS-C lenses	
[4:3]	[L] (41.5M)	7440×5584	[L] (18M)	4880×3664
	[M] (21M)	5296×3968	[M] (9M)	3472×2608
	[S] (10.5M)	3792×2848	[S] (4.5M)	2480×1856
[3:2]	[L] (46.5M)	8368×5584	[L] (20M)	5504×3664
	[M] (23.5M)	5952×3968	[M] (10M)	3920×2608
	[S] (12M)	4272×2848	[S] (5M)	2784×1856
[16:9]	[L] (39.5M)	8368×4712	[L] (17M)	5504×3096
	[M] (20M)	5952×3352	[M] (8M)	3840×2160
	[S] (10M)	4272×2400	[S] (2M)	1920×1080
[1:1]	[L] (31M)	5584×5584	[L] (13.5M)	3664×3664
	[M] (15.5M)	3968×3968	[M] (7M)	2608×2608
	[S] (8M)	2848×2848	[S] (3.5M)	1856×1856
[65:24]	[L] (26M)	8368×3088	—	
[2:1]	[L] (35M)	8368×4184	—	

- When [Ex. Tele Conv.] is set, the [M] and [S] image sizes are indicated with [EX].



- [Picture Size] is not available when the following functions are being used:
 - [6K/4K PHOTO]/[Post-Focus]
 - [RAW] ([Picture Quality])
 - [High Resolution Mode]
 - [Multiple Exposure]



- You can register functions to Fn buttons:



[] ⇒ [] ⇒ [Fn Button Set] ⇒ [Setting in REC mode] ⇒ [Picture Size]
(→ [278](#))

[Picture Quality]

iA P A S M 



Set the compression rate used for storing pictures.

 → [] → [] → Select [Picture Quality]

Setting	File format	Settings details
[FINE]	JPEG	JPEG images that give priority to image quality.
[STD.]		JPEG images of standard image quality. This is useful for increasing the number of recordable pictures without changing the picture size.
[RAW+FINE]	RAW+JPEG	This records RAW and JPEG images ([FINE] or [STD.]) simultaneously.
[RAW+STD.]		
[RAW]	RAW	This records RAW images.



Note on RAW

RAW format refers to a data format of images that have not been processed on the camera.

Playback and editing of RAW images require the camera or the dedicated software.



- You can process RAW images on the camera. (→ 271)
- Use software (“SILKYPIX Developer Studio” by Ichikawa Soft Laboratory) to process and edit RAW files on a PC. (→ 430)
- Pictures taken with [RAW] cannot be displayed enlarged to the maximum magnification during playback.
Take pictures with [RAW+FINE] or [RAW+STD.] if you want to check their focus on the camera after recording.



- RAW images are always recorded in the [L] size of the [3:2] aspect ratio.
- When you delete an image recorded with [RAW+FINE] or [RAW+STD.] on the camera, both the RAW and JPEG images will be deleted simultaneously.
- [Picture Quality] is not available when the following functions are being used:
 - [6K/4K PHOTO]/[Post-Focus]
 - [High Resolution Mode]
 - [Multiple Exposure]







- You can register functions to Fn buttons:

[] ⇒ [] ⇒ [Fn Button Set] ⇒ [Setting in REC mode] ⇒ [Picture Quality] (→ 278)

[Double Card Slot Function]

This sets the way recording to the card slots 1 and 2 is performed.

 ⇒  ⇒ [] ⇒ Select [Double Card Slot Function]

[Recording Method]	 [Relay Rec]	Selects the priority of card slots for recording. [Destination Card Slot]: [1 → 2]/[2 → 1] Relays recording to the card in the other card slot after the first card runs out of free space.
	 [Backup Rec]	Records the same images to both cards simultaneously.
	 [Allocation Rec]	Allows you to specify the card slot to be used for recording for different image formats. [JPEG/HLG Photo Destn.]/[RAW Destination]/[6K/4K Photo Destination]/[Video Destination]





- The double slot function is not available for AVCHD videos, as these cannot be recorded to card slot 1 (XQD card).

Notes about Backup Recording

- We recommend using cards of the same capacity.
- When using the following combinations of cards, recording videos, 6K/4K photos, and recording with [Post-Focus] are not available:
 - SDXC memory card and XQD card of 32 GB or less
 - SD memory card or SDHC memory card, and XQD card over 32 GB



- You can register card switching of [Destination Card Slot] to the Fn button:
 - [] ⇒ [] ⇒ [Fn Button Set] ⇒ [Setting in REC mode] ⇒ [Destination Card Slot] (→ 278)

[Folder / File Settings]

Set the folder and file name where to save the images.

Folder name		File name	
100ABCDE 		PABC0001.JPG 	
1	Folder number (3 digits, 100 to 999)	3	Color space ([P]: sRGB, [_]: AdobeRGB)
2	5-character user-defined segment	4	3-character user-defined segment
		5	File number (4 digits, 0001 to 9999)
		6	Extension

→ → [] → Select [Folder / File Settings]

[Select Folder]*	Selects a folder for storing images. <ul style="list-style-type: none"> The folder name and the number of files that can be stored will be indicated. 	
[Create a New Folder]	Creates a new folder with an incremented folder number. <ul style="list-style-type: none"> If there are no recordable folders in the card, a screen for resetting the folder number is displayed. 	
	[OK]	Increments the folder number without changing the 5-character user-defined segment (2 above).
	[Change]	Changes the 5-character user-defined segment (2 above). This will also increment the folder number.
[File Name Setting]	[Folder Number Link]	Uses the 3-character user-defined segment (4 above) to set the folder number (1 above).
	[User Setting]	Changes the 3-character user-defined segment (4 above).

* When [Double Card Slot Function] is set to [Allocation Rec], [Select Folder (Slot 1(XQD))] and [Select Folder (Slot 2(SD))] will be displayed.

- Follow the steps on page 369 when the character entry screen is displayed.
Available characters: alphabetic characters (upper-case), numerals, [_]



- Each folder can store up to 1000 files.
- File numbers are assigned sequentially from 0001 to 9999 in the order of recording.

If you change the storage folder, a number continuing on from the last file number will be assigned.



- In the following cases, a new folder with an incremented folder number will be created automatically when the next file is saved:
 - The number of files in the current folder reaches 1000.
 - The file number reaches 9999.
- New folders cannot be created when there are folders numbered from 100 all the way up to 999.

We recommend backing up your data and formatting the card.

- [Select Folder] is not available when [Backup Rec] in [Double Card Slot Function] is being used.

[File Number Reset]

Resets the file number of the next recording to 0001.

 ⇒ [] ⇒ [] ⇒ Select [File Number Reset]
Settings: [Card Slot 1(XQD)]/[Card Slot 2(SD)]



- When recording is performed after resetting this item, the folder number is updated and the file number starts from 0001.
- Folder numbers from 100 to 999 can be assigned.
When the folder number reaches 999, the file number cannot be reset.
We recommend backing up your data and formatting the card.
- **To reset the folder number to 100:**
 - ① Perform [Card Format] to format the card.
 - ② Perform [File Number Reset] to reset the file number.
 - ③ Select [Yes] on the folder number reset screen.

6. Focus/Zoom

Selecting the Focus Mode

iA P A S M 



Select the focusing method (focus mode) to match subject movement.

Set the focus mode lever.

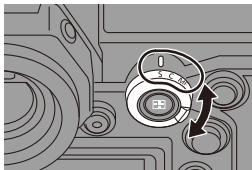

[S] ([AFS])	This is suitable for recording still subjects. While the shutter button is pressed halfway, this maintains a single point of focus. The focus stays locked while the shutter button is pressed halfway.
[C] ([AFC])	This is suitable for recording moving subjects. While the shutter button is pressed halfway, the focus is constantly adjusted according to the movement of the subject. <ul style="list-style-type: none">• This predicts the movement of the subject, maintaining focusing. (Movement prediction)
[MF]	Manual focusing. Use this when you want to fix the focus or avoid activating AF. (→ 117)



- [AFC] works in the same manner as [AFS] in the following situations:
 - [M] mode
 - In low light situations
- When the following functions are being used, [AFC] switches to [AFS]:
 - [65:24]/[2:1] ([Aspect Ratio])
 - [High Resolution Mode]
- When using [High Speed Video], [AFS] and [AFC] change to [MF].
- This function is not available for Post-Focus recording.

Using AF

iA P A S M



AF (Auto Focus) refers to automatic focusing.

Select the focus mode and the AF mode appropriate for the subject and scene.

1 Set the focus mode to [S] or [C].

- Set the focus mode lever. (→ 91)

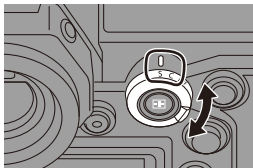

2 Select the AF mode.

- Press [] to display the AF mode selection screen, and set using or . (→ 98)
- In [iA] mode, each press of [] switches between [] and []. (→ 79)

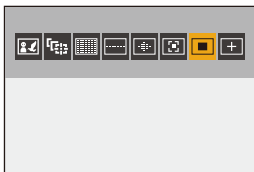

3 Press the shutter button halfway.

- The AF operates.
- If maintaining focus on the subject is difficult during video recording with [AFC], press the shutter button halfway again to re-adjust the focus.

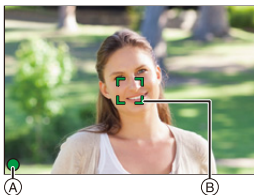

	Focus	
	In focus	Not in focus
Focus icon ^(A)	Lights	Blinking
AF area ^(B)	Green	Red
AF beep	Two beeps	—

Low illumination AF

- In dark environments, low illumination AF automatically operates, and the focus icon is indicated as [^{LOW}].
- Achieving focus may take more time than usual.

Starlight AF

- If the camera detects stars in the night sky after determining low illumination AF, then Starlight AF will be activated.
When focus is achieved, the focus icon will display [^{STAR}], and the AF area will be displayed on the area in focus.
- Edges of the screen cannot detect Starlight AF.

❖ [AF ON] button

You can also activate AF by pressing [AF ON].

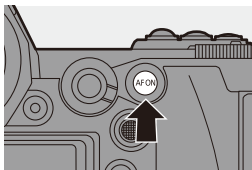

Subjects and recording conditions that make focusing difficult with AF mode

- Fast-moving subjects
- Extremely bright subjects
- Subjects without contrast
- Subjects recorded through windows
- Subjects near shiny objects
- Subjects in very dark locations
- When recording subjects both distant and near



- When recording with [AFC], if you move the zoom from the wide-angle end to the telephoto end, or suddenly reduce the distance to the subject, it may take time to achieve focus.
- If using the zoom after achieving focus, the focus may be erroneous. In that case, re-adjust the focus.



- The AF beep volume and sound can be changed:
[🔧] → [📶] → [Beep] → [AF Beep Volume]/[AF Beep Tone] (→ 354)

❖ Magnify the AF Area Position ([AF-Point Scope])



This magnifies the focus position when the AF mode is [□], [■], or [⊕].
(In other AF modes, the center of the screen is magnified.)

This magnifies the subject, allowing you to check focus and observe an enlarged subject as with a telephoto lens.

- Use the Fn button registered with [AF-Point Scope] to operate. In default settings, this is registered in [Fn1].

For information about the Fn button, refer to page 278.

On the recording screen, press and hold [Fn1].

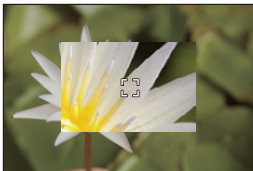
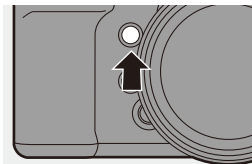

- Part of the screen is displayed enlarged while [Fn1] is pressed and held.
- When the screen is enlarged, pressing the shutter button halfway re-acquires focus in a small central AF area.
- When the screen is enlarged, turn  or  to adjust the magnification. Use  for more detailed adjustments.



- If the camera temperature rises under any of the following conditions,  may be displayed and use of AF Point Scope may not be possible. Wait until the camera cools down.

- During continuous usage of AF Point Scope
- When the ambient temperature is high
- When the screen is enlarged, [AFC] changes to [AFS].
- When the following functions are being used, AF Point Scope cannot be used:
 - Video recording/[6K/4K PHOTO]/[Post-Focus]
 - [65:24]/[2:1] ([Aspect Ratio])
 - [Miniature Effect] ([Filter Settings])
 - [Multiple Exposure]



- You can change the display method of the magnified screen:  ⇒ [] ⇒ [AF-Point Scope Setting] (→ [332](#))

[AF Custom Setting(Photo)]



Select features of AF operation when recording using [AFC] that are appropriate for the subject and scene.

Each of these features can be further customized.

1 Set the focus mode to [AFC]. (→ 91)

2 Set [AF Custom Setting(Photo)].

- → [CAMERA] → [FOCUS] → [AF Custom Setting(Photo)]



[Set 1]	Basic general-purpose setting
[Set 2]	Setting in which the subject moves in only one direction at a constant speed
[Set 3]	Setting for scenes in which the subject moves in random directions, and obstacles are likely to appear
[Set 4]	Setting for scenes where the speed of the subject changes significantly



- When the following function is being used, [AF Custom Setting(Photo)] is not available:

– [6K/4K PHOTO]

- You can register functions to Fn buttons:

[] → [] → [Fn Button Set] → [Setting in REC mode] → [AF Custom Setting(Photo)] (→ 278)

❖ Adjusting AF Custom Settings

- 1 Press ◀▶ to select the AF Custom setting type.
- 2 Press ▲▼ to select items and press ◀▶ to adjust.
 - To reset settings to the default, press [DISP].
- 3 Press  or .

[AF Sensitivity]	Sets the tracking sensitivity for the movement of subjects.	
	+	When the distance to the subject changes drastically, the camera re-adjusts the focus immediately. You can bring different subjects into focus one after another.
	–	When the distance to the subject changes drastically, the camera waits for a short period of time before re-adjusting the focus. This allows you to prevent the focus from being accidentally re-adjusted when, for example, an object moves across the image.
[AF Area Switching Sensitivity]	Sets the sensitivity for switching the AF area to match subject movement. (When in an AF mode where the AF area uses 225-area focusing)	
	+	When the subject moves out of the AF area, the camera immediately switches the AF area to keep the subject in focus.
	–	The camera switches the AF area at a gradual pace. Effects caused by a slight movement of the subject or by obstacles in front of the camera will be minimized.
[Moving Object Prediction]	Sets the level of movement prediction for changes in the speed of subject movement.	
	<ul style="list-style-type: none"> • At larger setting values, the camera tries to maintain focus by responding even to sudden movements of the subject. However, the camera becomes more sensitive to slight movements of the subject, so focusing may become unstable. 	
	0	This is suited to a subject with minimal changes in speed.
	+1	These are suited to a subject that changes its speed.
+2		

Selecting the AF Mode

iA P A S M 





Select the focusing method to match the position and number of subjects.

1 Press [].

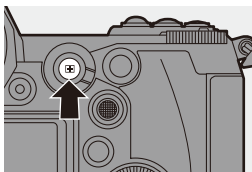







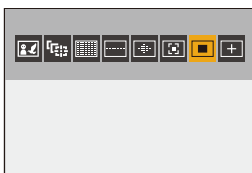

- The AF mode selection screen appears.



2 Select the AF mode.

- Press ◀▶ to select an item and then press  or .



	[Face/Eye/Body/ Animal Detect.]	→ 99
	[Tracking]	→ 102
	[225-Area]	→ 104
	[Zone (Vert./ Horz.)]	→ 105
	[Zone (Square)]*	→ 105
	[Zone (Oval)]	→ 105
	[1-Area+]	→ 107
	[1-Area]	→ 107
	[Pinpoint]	→ 108
	to [Custom1] to	→ 110
	[Custom3]*	

- * This is not displayed with the default settings. From [Show/Hide AF Mode], you can set the items to display on the selection screen. (→ 331)



- In [Time Lapse Shot], [⏮] cannot be used.
- When the focus mode is set to [AFC], [⊕] is not available.
- When the following functions are being used, the AF mode is fixed to [■]:
 - [65:24]/[2:1] ([Aspect Ratio])
 - [Miniature Effect] ([Filter Settings])
- The AF mode cannot be set when using Post-Focus.



[Face/Eye/Body/Animal Detect.]

The camera detects a person's face, eyes, and body (entire body or upper half of the body) and adjusts the focus.

With the default settings, animal detection will also operate, enabling detection of animals, such as birds, canines (including wolves), and felines (including lions).

When the camera detects a person's face (A/B) or body or an animal's body (C), an AF area is displayed.

Yellow	AF area to be brought into focus. The camera selects this automatically.
White	Displayed when multiple subjects are detected.

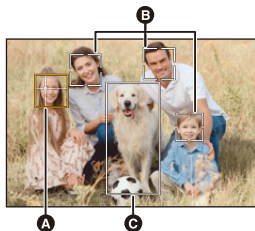

- Eye detection works only for the eyes inside the yellow frame (A).



- When a person's eyes are detected, the eye closer to the camera will be brought into focus.
The exposure will be adjusted to the face. (When [Metering Mode] is set to [☉])
- The camera can detect the faces of up to 15 people.
- The camera can detect a combined total of up to 3 human and animal bodies.
- If any humans or animals are not detected, the camera operates as [⏮].

❖ Specify the Person, Animal, or Eye to Bring into Focus

When the person or animal to be brought into focus is shown using the white AF area, you can change this to a yellow AF area.

• Touch operation

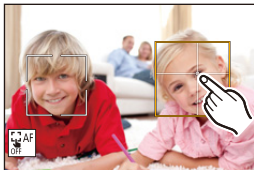

Touch the person, animal or eye indicated with the white AF area.

- The AF area will change to yellow.
- Touching outside the AF area displays the AF area setting screen. Touch [Set] to set the [] AF area at the position touched.
- To cancel the setting, touch [].







• Button operation

Press .

- Each press of  switches the person, animal or eye to be brought into focus.
- To cancel the settings specified, press  again.







❖ Enable/Disable Animal Detection

- 1 Press [] to display the AF mode selection screen.
- 2 Select [] and then press .
 - This disables animal detection, and the icon changes to [].
 - Press  again to enable animal detection.

❖ Move and Change the Size of the Yellow AF Area



You can move the yellow AF area to the position of the white AF area and replace the white AF area with the yellow AF area.

If moving to a position outside an AF area, then the [■] AF area will be set.

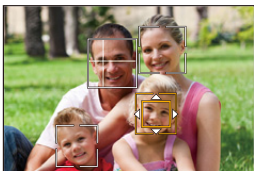
- 1 Press [] to display the AF mode selection screen.
- 2 Select [] and then press ▼.
- 3 Press ▲▼◀▶ to move the position of the AF area.
- 4 Rotate  or  to change the size of the AF area.
- 5 Press  .
 - On the recording screen, press  , or touch [] to cancel the AF area setting.



Operations on the AF area movement screen

Button operation	Touch operation	Description of operation
▲▼◀▶	Touch	Moves the AF area <ul style="list-style-type: none"> • Positions can be moved to the diagonal directions using the joystick.
	Pinch out/ pinch in	Enlarges/reduces the AF area in small steps.
	—	Enlarges/reduces the AF area.
[DISP.]	[Reset]	First time: Returns the AF area position to the center. Second time: Returns the AF area size to the default setting.



[Tracking]

When the focus mode is set to [AFC], the AF area follows the movement of the subject, maintaining focusing.



Start tracking.

- Aim the AF area over the subject, and press the shutter button halfway. The camera will track the subject while the shutter button is pressed halfway or pressed fully.
- The AF area turns red when tracking fails.
- When the focus mode is set to [AFS], focus will be aligned with the AF area position. Tracking will not work.





- In [M] mode, while recording video, and while recording with [6K/4K Burst(S/S)], tracking will continue even if the shutter button is released. To cancel tracking, press  or , or touch . Tracking is also available with [AFS].



- Set [Metering Mode] to [C] to continue to adjust the exposure as well.
- In the following,  operates as :
 - [Monochrome]/[L.Monochrome]/[L.Monochrome D]/[Monochrome(HLG)] ([Photo Style])
 - [Sepia]/[Monochrome]/[Dynamic Monochrome]/[Rough Monochrome]/[Silky Monochrome]/[Soft Focus]/[Star Filter]/[Sunshine] ([Filter Settings])
 - When the subject is small

❖ Move the Position of the AF Area

- 1 Press [] to display the AF mode selection screen.
- 2 Select [] and then press ▼.
- 3 Press ▲▼◀▶ to move the position of the AF area.
 - Positions can be moved to the diagonal directions using the joystick.
 - You can also move the AF area by touching.
 - To return the position back to the center, press [DISP].
- 4 Press  .





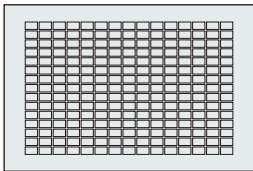



[225-Area]

The camera selects the most optimal AF area to focus from 225 areas. When multiple AF areas are selected, all selected AF areas will be brought into focus. When the focus mode is set to [AFC], ensuring that the subject stays within the 225 areas during recording will ensure the subject stays in focus.



❖ Specify the [AFC] Start Point

When the focus mode is set to [AFC], you can specify at which area to start [AFC].

- ❶ Set the focus mode to [AFC]. (→ 91)
- ❷ Set [AFC Start Point (225-Area)] to [ON].
 -  ⇒  ⇒ [] ⇒ [AFC Start Point (225-Area)] ⇒ [ON]
- ❸ Press [] to display the AF mode selection screen.
- ❹ Select [] and then press ▼.
 - After performing Steps ❶ and ❷, the icon changes from [] to [].
- ❺ Press ▲▼◀▶ to move the position of the AF area.
 - Positions can be moved to the diagonal directions using the joystick.
 - You can also move the AF area by touching.
 - To return the position back to the center, press [DISP.].
- ❻ Press .

[Zone (Vert./ Horz.)] / [Zone (Square)] / [Zone (Oval)]

[Zone (Vert./ Horz.)]

From the 225 AF areas, vertical and horizontal zones can be focused.

Horizontal pattern

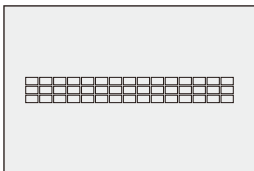

Vertical pattern

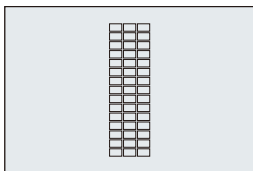

[Zone (Square)]

From the 225 AF areas, a central square zone can be focused.

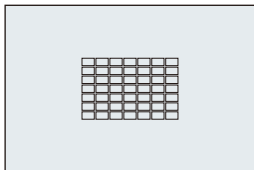





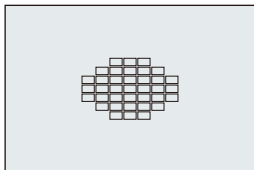





[Zone (Oval)]

From the 225 AF areas, a central oval zone can be focused.





-  is not displayed with default settings. Set [Zone (Square)] to [ON] in [Show/Hide AF Mode]. (→ 331)

❖ Move and Change the Size of the AF Area

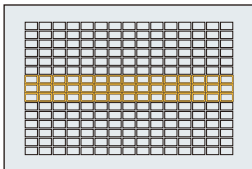
- ❶ Press [] to display the AF mode selection screen.
- ❷ Select [], [] or [] and then press ▼.
- ❸ Press ▲▼◀▶ to move the position of the AF area.
 - You can also move the AF area by touching.
 - When [] is selected
 - Press ▲▼ to switch to a horizontal pattern AF area.
 - Press ◀▶ to switch to a vertical pattern AF area.
 - When []/[] are selected
 - Positions can be moved to the diagonal directions using the joystick.
- ❹ Rotate  or  to change the size of the AF area.
 - You can also pinch out/pinch in the AF area to change the size.
 - The first press of [DISP.] returns the AF area position to the center. The second press returns the size of the AF area to the default.
- ❺ Press .



- ➔ • The display method for the AF area using 225-area focusing can be changed:
 [] ➔ [] ➔ [AF Area Display] (➔ 341)

[1-Area+]/ [1-Area]

[1-Area+]

Emphasis within a single AF area can be focused.

Even when the subject moves out of the single AF area, this remains focused in a supplementary AF area (A).

- Effective when recording moving subjects that are difficult to track with [].

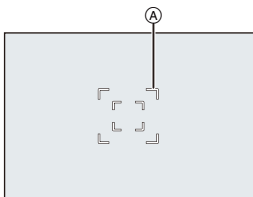





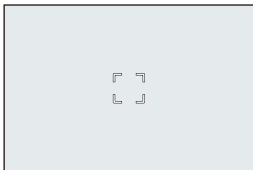

[1-Area]

Specify the position to be brought into focus.



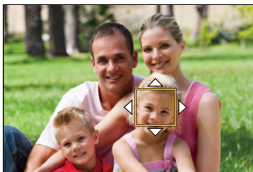

❖ Move and Change the Size of the AF Area

- 1 Press [] to display the AF mode selection screen.
- 2 Select [] or [] and then press ▼.
- 3 Press ▲▼◀▶ to move the position of the AF area.
- 4 Rotate  or  to change the size of the AF area.
- 5 Press .



Operations on the AF area movement screen

Button operation	Touch operation	Description of operation
	Touch	Moves the AF area <ul style="list-style-type: none"> • Positions can be moved to the diagonal directions using the joystick.
	Pinch out/ pinch in	Enlarges/reduces the AF area in small steps.
	—	Enlarges/reduces the AF area.
[DISP.]	[Reset]	First time: Returns the AF area position to the center. Second time: Returns the AF area size to the default setting.



- Change the movement speed of a single AF area:
[📷] ⇒ [FOCUS] ⇒ [1-Area AF Moving Speed] (→ 311)

[Pinpoint]





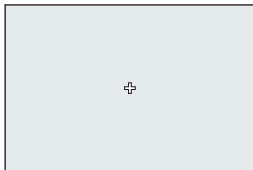



You can achieve a more precise focus on a small point.

If you press the shutter button halfway, the screen that lets you check the focus will be enlarged.







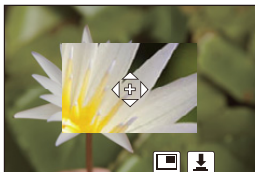

- When the focus mode is set to [AFC], [⊕] is not available.

❖ Move the Position of the AF Area

- 1 Press [] to display the AF mode selection screen.
- 2 Select [] and then press ▼.
- 3 Press ▲▼◀▶ to set the position of [] and then press  or  .
 - Positions can be moved to the diagonal directions using the joystick.
 - The selected position on the screen will be enlarged.
 - The AF area cannot be moved to the edge of the screen.
- 4 Press ▲▼◀▶ to fine-adjust the position of [].
- 5 Press  or  .





Operations on the Magnification Window



Button operation	Touch operation	Description of operation
▲▼◀▶	Touch	Moves []. <ul style="list-style-type: none"> • Positions can be moved to the diagonal directions using the joystick.
	Pinch out/ pinch in	Enlarges/reduces the screen in small steps.
	—	Enlarges/reduces the screen.
		Switches magnification window (windowed mode/full screen mode). 
[DISP.]	[Reset]	First time: Returns to the screen in Step 3. Second time: Returns the AF area position to the center.

- When the picture is displayed in windowed mode, you can enlarge the picture by approx. 3× to 6×; when the picture is displayed in full screen, you can enlarge the picture by approx. 3× to 10×.
- You can also take a picture by touching [].



- When the following functions are being used, [] switches to []:
– Video recording/[6K/4K PHOTO]



- You can change the display method of the magnified screen:
[] → [] → [Pinpoint AF Setting] (→ 331)

[C1] [C2] [C3] **[Custom1] to [Custom3]**

The shape of the AF area can be set freely in the 225 AF areas.





The set AF area can be registered using [] to [].

The AF area can also be moved while maintaining the set shape.



- This is not displayed with default settings. In [Show/Hide AF Mode], set [Custom1] to [Custom3] to [ON]. (→ 331)

Register the AF Area Shape

- 1 Press [] to display the AF mode selection screen.
- 2 Select one of [] to [] and then press .

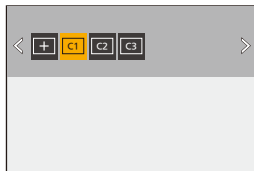

3 Select the AF area.



● Touch operation

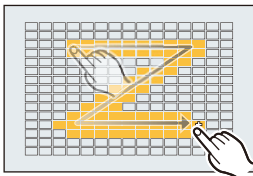

Touch the area to make the AF area.

- To select consecutive points, drag the screen.
- To cancel selection of the selected AF area, touch it again.



● Button operation

Press ▲▼◀▶ to select the AF area and then set with  or .
(Repeat this)

- Positions can be moved to the diagonal directions using the joystick.
- To cancel selection of the selected AF area, press  or  again.
- To cancel all selections, press [DISP.].

4 Press [Q].

◆ Move the Position of the AF Area

1 Press [] to display the AF mode selection screen.

2 Select a registered AF mode shape ([C1] to [C3]) and then press ▼.

3 Press ▲▼◀▶ to move the position of the AF area and then press



- Positions can be moved to the diagonal directions using the joystick.
- Press [DISP.] to return the [+] position to the center.

AF Area Movement Operation

iA P A S M 





In default settings, you can use the joystick to directly move and change the size of the AF area when recording.

1 Move the position of the AF area.

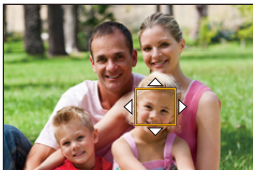

- On the recording screen, tilt the joystick.

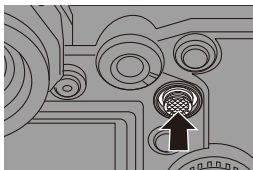

- Pressing  enables switching between the default and set AF area positions.
In [, this operation switches the person, animal or eye to be brought into focus.
Display the magnified screen with [].



2 Change the size of the AF area.

- Rotate  or .
- Use  for more detailed adjustments.
- The first press of [DISP.] returns the AF area position to the center. The second press returns the size of the AF area to the default.

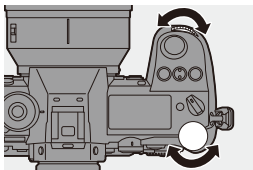

3 Confirm your selection.

- Press the shutter button halfway.
- Return to the recording screen.
- For [AF], on the recording screen, press  to cancel the AF area setting.

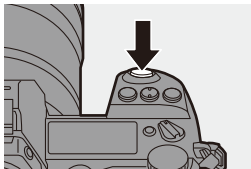

- When [Metering Mode] is [M], the metering target also moves together with the AF area.
- In [M], [AF-C], [AF-ON], [C1], and [C3], the size of the AF area cannot be changed.
- In [M], moving the AF area and changing the size are not possible.
- You can set the AF area to loop when moved:
[M] → [AF] → [Looped Focus Frame] (→ 333)

Moving the AF Area by Touch

You can move the AF area to a touched position on the monitor.
You can also change the size of the AF area.

 → [M] → [Touch Settings] →
Select [Touch AF]

[AF]	This focuses on the touched subject.
[AF+AE]	This focuses on and adjusts brightness for the touched subject.
[OFF]	—



❖ Focus on the Touched Position ([AF])

- 1 Touch the subject.
 - Moves the AF area to the touched position.
- 2 Pinch in/pinch out to change the AF area size.
 - The first touch of [Reset] returns the AF area position to the center. The second press returns the size of the AF area to the default.
- 3 Touch [Set].
 - In [+], touch [Exit].
 - For [], on the recording screen, touch [] to cancel the AF area setting.

❖ Focus on and Adjust Brightness for the Touched Position ([AF+AE])

- 1 Touch the subject to which you wish to adjust the brightness.
 - At the touched position, an AF area that works in the same way as [] is displayed.
This places a point to adjust brightness at the center of the AF area.
- 2 Pinch in/pinch out to change the AF area size.
 - The first touch of [Reset] returns the AF area position to the center. The second press returns the size of the AF area to the default.
- 3 Touch [Set].
 - On the recording screen, touch [] (when [] or [] is set: []) to cancel the [AF+AE] setting.

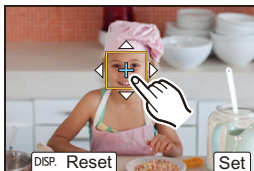

Moving the AF Area Position with the Touch Pad

During viewfinder display, you can touch the monitor to change the position and size of the AF area.

1 Set [Touch Pad AF].

-  → [] → [] → [Touch Settings] → [Touch Pad AF] → [EXACT]/[OFFSET]

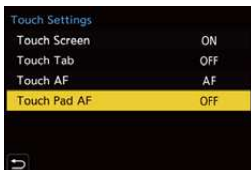



2 Move the position of the AF area.

- During viewfinder display, touch the monitor.



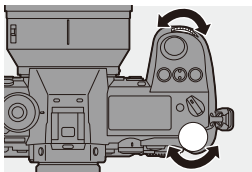

3 Change the size of the AF area.

- Rotate  or .
- Use  for more detailed adjustments.
- The first press of [DISP.] returns the AF area position to the center. The second press returns the size of the AF area to the default.



4 Confirm your selection.

- Press the shutter button halfway.
- For [], on the recording screen, press  to cancel the AF area setting.

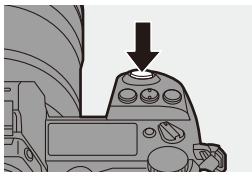

❖ Setting Items ([Touch Pad AF])

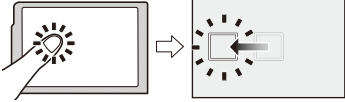
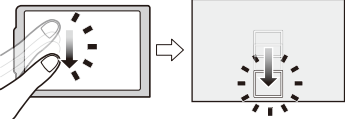
[EXACT]	Moves the AF area of the viewfinder by touching a desired position on the touch pad.	
[OFFSET]	Moves the AF area of the viewfinder according to the distance you drag the touch pad.	
[OFF]	—	—

[Focus Switching for Vert / Hor]

Memorizes separate positions for AF areas for when the camera is vertically aligned and for when it is horizontally aligned.

Two vertical orientations, left and right, are available.



MENU SET → [⚙️] → [AF] → Select [Focus Switching for Vert / Hor]

[ON]	Memorizes separate positions for vertical and horizontal orientations.
[OFF]	Sets the same position for vertical and horizontal orientations.



- In MF, this memorizes the MF Assist display position.
- This does not work when using [] or [C1] to [C3].

Record Using MF

iA P A S M 



MF (Manual Focus) refers to manual focusing.

Use this function when you want to fix the focus or when the distance between the lens and the subject is determined and you do not want to activate AF.

1 Set the focus mode lever to [MF].

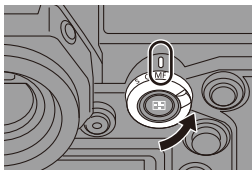

2 Select the point to be brought into focus.

- Tilt the joystick to select the point to bring into focus.
- Even by pressing [], you can display the focus position movement screen.
- To return the position to be brought into focus to the center, press [DISP.].

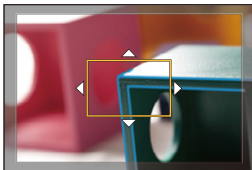

3 Confirm your selection.

- Press .
- This switches to the MF Assist screen, and shows an enlarged display.

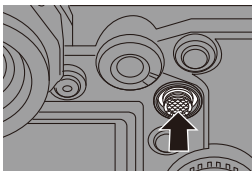

4 Adjust the focus.

- Rotate the focus ring.
- Ⓐ MF Assist (enlarged screen)
 - This will display the in-focus portion highlighted with color. (Peaking Ⓑ)
 - A recording distance guideline is displayed.
- (MF Guide Ⓒ)
- Ⓓ Indicator for ∞ (infinity)

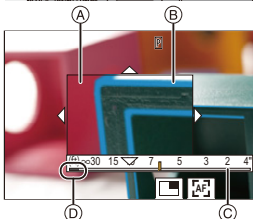
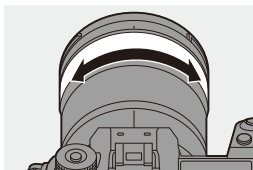

5 Close the MF Assist screen.





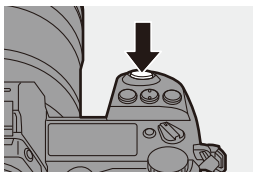

- Press the shutter button halfway.
- This operation can also be performed by pressing .

6 Start recording.

- Press the shutter button fully.

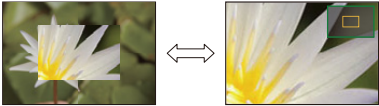

❖ Operations on the MF Assist Screen

Button operation	Touch operation	Description of operation
	Drag	Moves the enlarged display position. <ul style="list-style-type: none"> Positions can be moved to the diagonal directions using the joystick.
	Pinch out/ pinch in	Enlarges/reduces the screen in small steps.
	—	Enlarges/reduces the screen.
		Switches magnification window (windowed mode/full screen mode). 
[DISP.]	[Reset]	First time: Returns the MF Assist position to the center. Second time: Returns the MF Assist size to the default setting.
[AF ON]		The AF operates.

- When the picture is displayed in windowed mode, you can enlarge the picture by approx. 3× to 6×; when the picture is displayed in full screen, you can enlarge the picture by approx. 3× to 20×.



- On the recording screen, you can rotate the focus ring to display the MF Assist screen. If you have enlarged the picture by rotating the focus ring, the assist screen will close approx. 10 seconds after the operation.
- During MF, pressing [AF ON] will activate AF.
- The recording distance reference mark is a mark used to measure the focus distance. Use this when taking pictures with MF or taking close-up pictures.

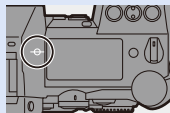

- Change the peaking sensitivity and the display method:
[] ⇒ [] ⇒ [Focus Peaking] (→ 310)
- Memorizes the MF Assist position separately for vertical and horizontal orientations:
[] ⇒ [] ⇒ [Focus Switching for Vert / Hor] (→ 116)
- You can change the display method of the magnified screen:
[] ⇒ [] ⇒ [MF Assist] (→ 330)
- Change the MF Guide display method:
[] ⇒ [] ⇒ [MF Guide] (→ 330)
- Disable focus ring operation:
[] ⇒ [] ⇒ [Focus Ring Lock] (→ 330)
- Set the movement of the MF Assist position to loop:
[] ⇒ [] ⇒ [Looped Focus Frame] (→ 333)
- The camera memorizes the focus position when you turn it off:
[] ⇒ [] ⇒ [Lens Focus Resume] (→ 348)
- The amount of focus movement can be set:
[] ⇒ [] ⇒ [Focus Ring Control] (→ 348)

Recording Images with Zoom

iA P A S M 



Use the optical zoom of the lens to zoom to telephoto or wide-angle.

When taking pictures, use [Ex. Tele Conv.] to increase a telescopic effect without image deterioration.

When recording videos, use [Image Area of Video] to obtain the same telescopic effect as [Ex. Tele Conv.].

- For details about [Image Area of Video], refer to page [238](#).

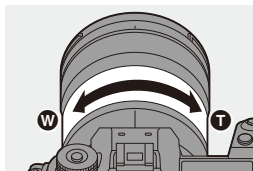

Rotate the zoom ring.

- T**: Telephoto
- W**: Wide-angle

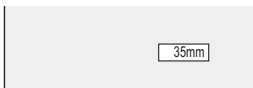

- Rotating the zoom ring displays the focal length on the recording screen.



- The focal length display can be hidden:
[] → [] → [Focal Length] (→ [344](#))

Extended Tele Conversion



[Ex. Tele Conv.] enables you to take pictures that are further enlarged beyond what is available with the optical zoom, without any deterioration in image quality.

- The [Ex. Tele Conv.] maximum magnification ratio differs depending on the [Picture Size] set in the [Photo] ([Image Quality]) menu.
 - Set to [EX]M]: 1.4×
 - Set to [EX]S]: 2.0×

1 Set [Picture Size] to [M] or [S].

- → [📷] → [🔍] → [Picture Size] → [M] or [S]

2 Set [Ex. Tele Conv.].

- → [📷] → [🔍] → [Ex. Tele Conv.]

[ZOOM]	Changes the zoom magnification.
[TELE CONV.]	Fixes the zoom magnification at the maximum.
[OFF]	—

❖ Changing the Zoom Magnification

Button operation

- 1 Set [Ex. Tele Conv.] to [ZOOM].
 - ⇒ [] ⇒ [] ⇒ [Ex. Tele Conv.] ⇒ [ZOOM]
- 2 Set the Fn button to [Zoom Control]. (→ 278)
- 3 Press the Fn button.
- 4 Press the cursor buttons to operate the zoom.
 - ▲▶: T (telephoto)
 - ◀▼: W (wide-angle)
 - Press the Fn button again, or wait a specified time to end zoom operation.
 - Displayed zoom magnifications (A) are approximate.



Touch operation

- With the default settings, the Touch Tab is not displayed. Set [Touch Tab] to [ON] in [Touch Settings]. (→ 333)

- 1 Set [Ex. Tele Conv.] to [ZOOM].
 - ⇒ [] ⇒ [] ⇒ [Ex. Tele Conv.] ⇒ [ZOOM]
- 2 Touch [].
- 3 Touch [].





- 4 Drag the slide bar to operate the zoom.

- T: Telephoto
- W: Wide-angle

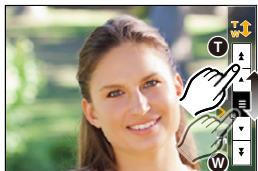
- To end Touch Zoom operations, touch [] again.



- You can register functions to Fn buttons:

[] ⇒ [] ⇒ [Fn Button Set] ⇒ [Setting in REC mode] ⇒ [Ex. Tele Conv.] (→ 278)

- When displaying the [Ex. Tele Conv.] setting screen using the Fn button, pressing [DISP.] allows you to change the [Picture Size] setting.



- [Ex. Tele Conv.] is not available when the following functions are being used:
 - 6K photo
 - [65:24]/[2:1] ([Aspect Ratio])
 - [RAW] ([Picture Quality])
 - [HLG Photo]
 - [High Resolution Mode]
 - [Toy Effect]/[Toy Pop] ([Filter Settings])
 - [Post-Focus] (only when [6K 18M] is set)
 - [Multiple Exposure]
- [ZOOM] in [Ex. Tele Conv.] is not available when the following functions are being used:
 - [6K/4K PHOTO]/[Post-Focus]

7. Drive/Shutter

Selecting the Drive Mode



You can switch the drive mode to Single, Burst, etc. to match the recording conditions.

Rotating the drive mode dial.

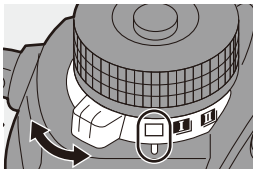

	Single	Takes one picture each time the shutter button is pressed.
	Burst (→ 126, 130)	Takes pictures continuously while the shutter button is pressed and held. 6K/4K photo recording is also possible.
	Time Lapse Shot/ Stop Motion Animation (→ 145, 148)	Takes pictures with Time Lapse Shot or Stop Motion Animation.
	Self-timer (→ 153)	Takes pictures when the set time elapses after the shutter button is pressed.



- You can register functions to Fn buttons:

[] → [] → [Fn Button Set] → [Setting in REC mode] → [Drive Mode]
(→ 278)



Taking Burst Pictures

iA P A S M 







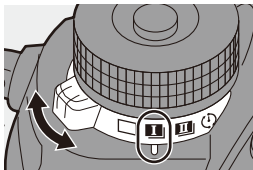

Takes pictures continuously while the shutter button is pressed and held. You can choose a burst setting which enables burst recording in high image quality, [H], [M] or [L], or one which enables high-speed burst recording, [] (6K/4K photo), to suit the recording conditions.

1 Set the drive mode dial to [] (Burst Shot 1) or [] (Burst Shot 2).

- Configure the burst settings for each of [] and [].



2 Select the burst rate.

-  → [] → [] → [Burst Shot 1 Setting]/[Burst Shot 2 Setting]
- With the default settings, [H] is set for [] and [] is set for [].

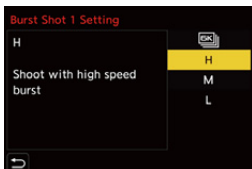

	For information about 6K/4K photo recording, refer to “6K/4K Photo Recording”. (→ 130)
[H]	Takes high-speed burst pictures.
[M]	Takes medium-speed burst pictures.
[L]	Takes low-speed burst pictures.

3 Close the menu.

- Press the shutter button halfway.

4 Start recording.

- Takes burst pictures while the shutter button is pressed fully.

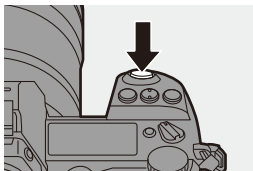

❖ Burst Rate

	Mechanical shutter, electronic front curtain	Electronic shutter	Live View when taking burst pictures
[H] (High speed)	9 frames/second ([AFS]/[MF]) 6 frames/second ([AFC])	9 frames/second ([AFS]/[MF]) 5 frames/second ([AFC])	None ([AFS]/[MF]) Available ([AFC])
[M] (Medium speed)	5 frames/second	5 frames/second	Available
[L] (Low speed)	2 frames/second	2 frames/second	Available

- The burst rate may be lower depending on the settings for recording such as [Picture Size] and focus mode.

❖ Number of burst picture frames

	[Picture Quality]		
	[FINE]/[STD.]	[RAW+FINE]/ [RAW+STD.]	[RAW]
[H] (High speed)	50 frames or more	35 frames or more	40 frames or more
[M] (Medium speed)			
[L] (Low speed)			

- When recording under the test conditions specified by Panasonic.
The number of burst picture frames that can be taken becomes fewer depending on the recording conditions.
- The burst rate will become lower during recording but pictures can continue to be taken until the card becomes full.

❖ Number of Pictures That Can Be Taken Continuously

When you press the shutter button halfway, the number of pictures that can be taken continuously will appear on the recording screen and the status LCD.

Example) When 20 frames: [r20]

- Once recording starts, the number of pictures that can be taken continuously will decrease. When [r0] appears, the burst rate decreases.
- When [r99+] is displayed on the recording screen, you can take 100 or more burst pictures.



❖ Focus when Taking Burst Pictures

Focus mode	[Focus/Shutter Priority]	[H]	[M]/[L]
[AFS]	[FOCUS]	Fixed to the focus of the first frame	
	[BALANCE]		
	[RELEASE]		
[AFC]	[FOCUS]	Estimated focus	Normal focus
	[BALANCE]	Estimated focus	
	[RELEASE]		
[MF]	—	Focus set with manual focus	

- When the subject is dark with [AFC], the focus is fixed to that of the first frame.
- With estimated focus, the burst rate takes priority and the focus is estimated to the extent possible.
- With normal focus, the burst rate may become slow.

❖ Exposure when Taking Burst Pictures

Focus mode	[H]	[M]/[L]
[AFS]	Fixed to the exposure of the first frame	The exposure is adjusted for each frame
[AFC]	The exposure is adjusted for each frame	
[MF]	Fixed to the exposure of the first frame	



- It may take a while to save burst pictures.
If you continue to take burst pictures while saving is in progress, the number of burst picture frames that can be taken will be reduced.
When taking burst pictures, we recommend using a high-speed card.
- We recommend using the Shutter Remote Control (DMW-RS2: optional) when taking burst pictures with the shutter button pressed.
- Taking burst pictures does not work while you are using the following functions:
 - [High Resolution Mode]
 - [Rough Monochrome]/[Silky Monochrome]/[Miniature Effect]/[Soft Focus]/[Star Filter]/[Sunshine] ([Filter Settings])
 - [Post-Focus]
 - [Multiple Exposure]

6K/4K Photo Recording

iA P A S M 



With 6K Photo, you can take high-speed burst pictures at 30 frames/second and save the desired pictures, each made up of approx. 18 million pixels, extracted from their burst file.

With 4K Photo, you can take high-speed burst pictures at 60 frames/second and save the desired pictures, each made up of approx. 8 million pixels.

- “6K PHOTO” is a high-speed burst picture function to extract and save the desired pictures from images with an aspect ratio for pictures of 4:3 or 3:2 and an effective picture size equivalent to the number of pixels (approx. 18 megapixels) for images of 6K size (around 6,000 wide×3,000 high).





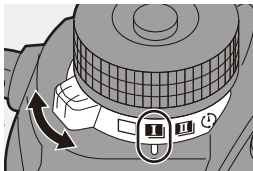

- Use a card rated at UHS Speed Class 3 or higher when using an SD card for this function.
- The angle of view becomes narrower.

1 Set the drive mode dial to **[I]** (Burst Shot 1) or **[II]** (Burst Shot 2).

- Configure the burst settings for each of **[I]** and **[II]**.



2 Select **[6K/4K PHOTO]**.

-  →  →  → [Burst Shot 1 Setting]/[Burst Shot 2 Setting] → 
- With the default settings,  is set for **[II]**.

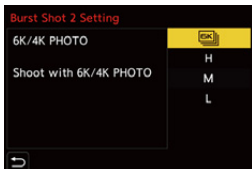

3 Select [Picture Size / Burst Speed].

-  →  →  → [6K/4K PHOTO] → [Picture Size / Burst Speed]



	Picture size	Burst rate
[6K 18M]*1	[4:3]: 4992×3744	30 frames/second
	[3:2]: 5184×3456	
[4K H 8M]*2	[4:3]: 3328×2496	60 frames/second
	[3:2]: 3504×2336	
[4K 8M]*2	[16:9]: 3840×2160	30 frames/second
	[1:1]: 2880×2880	

*1 6K photo

*2 4K photo

4 Select [Rec Method].

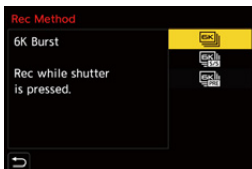



  
[6K/4K Burst]

When you wish to capture the best moments of a fast-moving subject

Takes burst pictures while the shutter button is pressed.

Audio recording: None

 <p>[6K/4K Burst(S/S)]</p> <p>"S/S" is an abbreviation for start/stop.</p>	<p>When you wish to capture an unpredictable photo opportunity</p> <p>Starts taking burst pictures when the shutter button is pressed. Pressing the button again stops taking burst pictures.</p> <p>The start tone and stop tone are output.</p>			
 <p>[6K/4K Pre-Burst]</p>	<p>When you wish to capture at the moment of a photo opportunity</p> <p>Takes burst pictures for approx. 1 second before and after the moment the shutter button is pressed. The shutter sound is output once only.</p> <table border="1" data-bbox="409 569 970 643"> <tr> <td data-bbox="409 569 688 643"> Recording duration: Approx. 2 seconds </td> <td data-bbox="688 569 970 643"> Audio recording: None </td> </tr> </table>		Recording duration: Approx. 2 seconds	Audio recording: None
Recording duration: Approx. 2 seconds	Audio recording: None			

* Audio is not played back during playback with the camera.

5 Close the menu.

- Press the shutter button halfway.

6 Start recording.

- [Continuous AF] works and the focus is adjusted continuously during recording with AF.

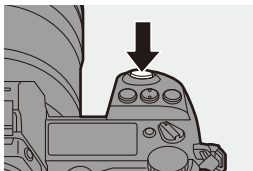

[6K/4K Burst]

- 1 Press the shutter button halfway.
- 2 Press the shutter button fully and keep it pressed during recording.

- (A) Press and hold
(B) Recording is performed

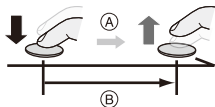

- Press the shutter button fully early because recording will take approx. 0.5 second to start after it is pressed fully.
- Even if you remove your finger from the shutter button immediately after the start of recording, recording may be performed for a maximum of approx. 1.5 seconds after you remove it.

[6K/4K Burst(S/S)]

- 1 Press the shutter button fully to start recording.
- 2 Press the shutter button fully again to stop recording.

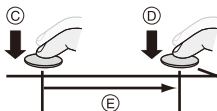

- Ⓒ Start (First)
- Ⓓ Stop (Second)
- Ⓔ Recording is performed

- You can add markers by pressing [Q] during recording. (Up to 40 markers per recording)

This allows you to skip to the positions where you added markers when selecting pictures from a 6K/4K burst file.

[6K/4K Pre-Burst]

Press the shutter button fully.

- Ⓕ Approx. 1 second
- Ⓖ Recording is performed

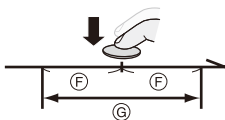

- While the recording screen is displayed, the AF will operate constantly to continue focusing.

The exposure is also adjusted continuously, except in [M] mode.

- When the subject is not at the center, use AF/AE Lock if you wish to lock the focus and exposure. (→ 191)

- The camera takes burst pictures and saves the data as a 6K/4K burst file for which [Rec. File Format] is [MP4].
- In default settings, Auto Review operates, and a screen that lets you select pictures from a burst file will be displayed.

To continue recording, press the shutter button halfway to return to the recording screen.

For how to select and save pictures from a recorded 6K/4K burst file, refer to page 138.



- The continuous recordable time varies depending on the [Picture Size / Burst Speed] setting.
 - [6K 18M]: 10 minutes
 - [4K H 8M]/[4K 8M]: 15 minutes
- The file save method differs depending on the type of card.
 - SDHC memory card, XQD card of 32 GB or less:
A new file will be created to continue recording if the file size exceeds 4 GB.
 - SDXC memory card, XQD card over 32 GB:
Files are not divided for recording.
- If the camera temperature rises under the any of following conditions, [] may be displayed and recording may stop. Wait until the camera cools down.
 - When 6K/4K photo recording is performed continuously
 - When using [6K/4K Pre-Burst]
 - When using [Pre-Burst Recording]
 - When the ambient temperature is high
- When [6K/4K Pre-Burst] or [Pre-Burst Recording] is set, the battery drains faster and the camera temperature rises. Set these settings only when recording.

❖ [Pre-Burst Recording] ([6K/4K Burst]/[6K/4K Burst(S/S)])

The camera starts recording approx. 1 second before the shutter button is pressed fully, so you will not miss a photo opportunity.



⇒ [] ⇒ [] ⇒ [6K/4K PHOTO] ⇒ Select [Pre-Burst Recording]
Settings: [ON]/[OFF]



- [PRE] is displayed on the recording screen.
- The AF operation and function limitations are the same as with [6K/4K Pre-Burst].

Notes on 6K/4K Photos

❖ Shutter Sound for Recording

An electronic shutter is used for 6K/4K photo recording. You can set a shutter sound or beep tone in [Beep] of the [Setup] ([IN/OUT]) menu.

(→ 354)

- High-speed burst pictures can be taken quietly when used in combination with [Silent Mode]. (→ 169)

❖ Difficult Recording Scenes

Recording in extremely bright locations or indoors

When you record in an extremely bright location or under fluorescent/LED lighting, the color tone or brightness of the image may change or horizontal stripes may appear on the screen.

Lowering the shutter speed may reduce the effect of horizontal stripes.

Fast-moving subjects

If you record a fast-moving subject, it may appear distorted in the recorded image.

❖ Camera Settings for 6K/4K Photo

The settings are automatically switched to the optimal settings for 6K/4K photo recording.

- The following [Photo] menus are fixed:

[Picture Size]*	[6K] (18 M)	[Picture Quality]	[FINE]
	[4K] (8 M)	[Shutter Type]	[ELEC.]

- 6K/4K burst files are taken using the following settings.

The settings in the [Video] menu are not applied to 6K/4K burst files.

[Rec. File Format]	[MP4]	[Continuous AF]	[ON]
[Rec Quality]*	[6K/200M/30p] [4K/150M/60p] [4K/100M/30p]	[Luminance Level]	[0-1023] (when 6K photo recording) [0-255] (when 4K photo recording)

* Switches to a setting that matches the [Picture Size / Burst Speed] setting.

- With 6K/4K photo recording, the ranges that the following functions can be set differ from when taking pictures:
 - Shutter speed: 1/30 (1/60 when [4K H 8M] is set) to 1/16000
 - [Min. Shutter Speed]: [1/1000] to [1/30] ([1/60] when [4K H 8M] is set)
 - Exposure compensation: ± 3 EV
- With 6K/4K photo recording, the following functions are not available:
 - Flash
 - Bracket recording
 - Program Shift
 - AF mode (+)
 - [MF Assist] ([6K/4K Pre-Burst] only)



- The following functions are not available during 6K/4K photo recording:
 - HDMI output
- Using HDMI output results in the following:
 - [6K/4K Pre-Burst] changes to [6K/4K Burst].
 - [Pre-Burst Recording] is not available.
- 6K/4K photo recording does not work while you are using the following functions:
 - [High Resolution Mode]
 - [Rough Monochrome]/[Silky Monochrome]/[Miniature Effect]/[Soft Focus]/[Star Filter]/[Sunshine] ([Filter Settings])
 - [Post-Focus]
 - [Multiple Exposure]
- When using APS-C lenses, 6K photo is not available.

Selecting Pictures from a 6K/4K Burst File

1 Select a 6K/4K burst file on the playback screen. (→ 259)

- Select an image with the [▲] or [▶] icon and then press ▲.
- You can also perform the same operation by touching [▶] or [▶].



- If the images were recorded with [6K/4K Pre-Burst], proceed to Step 3.

2 Roughly select the scene.

- Drag the slide bar (A).
- For information about how to use the picture selection slide view screen, refer to page 141.
- If the images were recorded with [6K/4K Burst] or [6K/4K Burst(S/S)], touching [▶] allows you to select the scene in the 6K/4K burst playback screen. (→ 142)

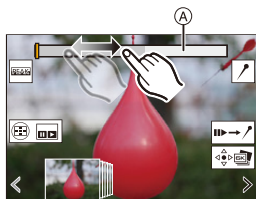



Picture selection slide view screen

3 Select the frame to save.

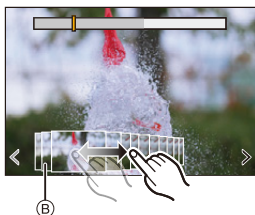
- Drag the picture selection slide view (B).
- You can also perform the same operation by pressing ◀▶.
- To continuously rewind or forward frame-by-frame, touch and hold [◀] or [▶].



4 Save the picture.

- Touch [] or [.
- A confirmation screen appears.



- The picture is saved in JPEG format.
- The recording information (Exif information), such as the shutter speed, aperture, and ISO sensitivity, is also saved with the picture that is saved.

Correcting Pictures After Recording (Post-Recording Refinement)

❖ Correcting Distortion in Pictures ([Reduce Rolling Shutter])

When saving pictures, correct any distortion caused by the electronic shutter (rolling shutter effect).



- 1 On the save confirmation screen in Step 4 on page 139, touch [Reduce Rolling Shutter].
 - If correction is not effective, the confirmation screen returns.
- 2 Check the correction result and then touch [Save].
 - To check the corrected and uncorrected versions of the picture, touch [Set/Cancel].



- The angle of view may become narrower if correction is performed.
- The correction may appear unnatural due to the movement of subjects.
- The camera may not be able to correct images recorded with other than this camera.

❖ Reducing Noise Caused by High Sensitivity ([6K/4K PHOTO Noise Reduction])

When saving pictures, reduce the noise that occurs due to high ISO sensitivity.

 ⇒  ⇒  ⇒ Select [6K/4K PHOTO Noise Reduction]
Settings: [AUTO]/[OFF]



- This is not applied to pictures saved with [6K/4K PHOTO Bulk Saving].
- The camera may not be able to reduce the noise in images recorded with other than this camera.



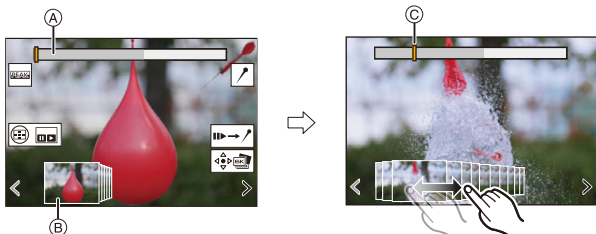

Picture Selection Operations

❖ Picture Selection Slide View Screen Operations



- (A) Slide bar
 (B) Picture selection slide view
 (C) Position of displayed frame

Button operation	Touch operation	Description of operation
	Drag/ < >	Selects a frame. <ul style="list-style-type: none"> To change the frames displayed in the picture selection slide view, select the frame at the left/right end and then touch [<] or [>].
Press and hold 	< > Touch and hold	Continuously rewinds or forwards frame-by-frame.
—	 Touch/drag	Selects the frame to display.
	Pinch out/ pinch in	Enlarges or reduces the display.
	—	Selects a frame while maintaining the enlarged display (during enlarged display).
	Drag	Moves the enlarged display position (during enlarged display).
[]		Displays the 6K/4K burst playback screen.

—		Switches to marker operation.
—		Adds or deletes a marker.
—		Displays the in-focus portion highlighted with color ([Focus Peaking]). • Switches in the order of [OFF] → [ON].
 / 	 / 	Saves the picture.

- During marker operation, you can skip to set markers or the beginning or end of the 6K/4K burst file. Touching [] returns to the original operation.

Button operation	Touch operation	Description of operation
		Moves to the next marker.
		Moves to the previous marker.

❖ 6K/4K Burst Playback Screen Operations

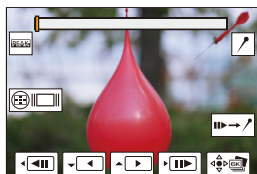

While paused



During continuous playback

Button operation	Touch operation	Description of operation
		Performs continuous playback or pauses (during continuous playback).
		Performs continuous rewind playback or pauses (during continuous rewind playback).

		Performs fast-forward playback or performs frame-by-frame forwarding (while paused).
		Performs fast-rewind playback or performs frame-by-frame rewinding (while paused).
—	 Touch/drag	Selects the frame to display (while paused).
	Pinch out/ pinch in	Enlarges or reduces the display (while paused).
	—	Selects a frame while maintaining the enlarged display (during enlarged display).
	Drag	Moves the enlarged display position (during enlarged display).
		Displays the picture selection slide view screen (while paused).
—		Switches to marker operation.
—		Adds or deletes a marker.
—		Displays the in-focus portion highlighted with color ([Focus Peaking]). • Switches in the order of [OFF] → [ON].
		Saves the picture (while paused).



- To select and save pictures from a 6K/4K burst file on a PC, use the “PHOTOfunSTUDIO” software. However, please note that 6K/4K burst files cannot be edited as videos in “PHOTOfunSTUDIO”.
- To play and edit 6K burst files, you need a high-performance PC environment. We recommend selecting and saving pictures with the camera.

❖ Selecting and Saving Pictures Using a TV Screen

- 6K burst files are output to a TV connected via HDMI at a resolution of [4K].
- Set [HDMI Mode (Playback)] of the [Setup] ([IN/OUT]) menu to either [AUTO] or a setting with a resolution of [4K]. (→ 357)

When connecting to a TV that does not support 4K videos, select [AUTO].

- Only the 6K/4K burst playback screen will be displayed on the TV.

❖ [6K/4K PHOTO Bulk Saving]

You can save any 5 second period of pictures from a 6K/4K burst file all at once.

1 Select [6K/4K PHOTO Bulk Saving].

-  ⇒ [] ⇒ [] ⇒ [6K/4K PHOTO Bulk Saving]

2 Press ◀▶ to select a 6K/4K burst file and then press or .



- If the burst time is 5 seconds or less, all frames are saved as pictures.

3 Select the first frame of the pictures to be saved all at once and then press or .

- The selection method is the same as that for selecting pictures from a 6K/4K burst file.
- The pictures are saved as a group of burst pictures in JPEG format.



- You can register functions to Fn buttons:

[] ⇒ [] ⇒ [Fn Button Set] ⇒ [Setting in PLAY mode] ⇒ [6K/4K PHOTO Bulk Saving] (→ 278)

Recording with Time Lapse Shot

iA P A S M 



Pictures are taken automatically at a set recording interval.

This feature is ideal for keeping track of changes over time in subjects such as animals and plants.



The pictures taken will be saved as a set of group images that can also be combined into a video.

-  • Check that the clock is set correctly. (→ 53)
- For long recording intervals, we recommend setting [Lens Focus Resume] to [ON] in the [Custom] ([Lens / Others]) menu.

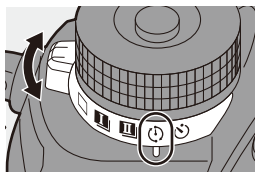
1 Set the drive mode dial to [].



2 Set [Mode] to [Time Lapse Shot].

-  → [] → [] → [Time Lapse/Animation] → [Mode] → [Time Lapse Shot]



3 Set the recording settings.

[Mode]	Switches between Time Lapse Shot and Stop Motion Animation.	
[Shooting Interval Setting]	[ON]	Sets the interval before the next recording takes place.
	[OFF]	Takes pictures without leaving recording intervals.

[Start Time]	[Now]	Starts recording when the shutter button is pressed fully.
	[Start Time Set]	Starts recording at the set time.
[Image Count]/ [Shooting Interval]	Sets the number of pictures and the recording interval to be taken. <ul style="list-style-type: none"> • [Shooting Interval] is not displayed when [Shooting Interval Setting] is set to [OFF]. 	
[Exposure Leveling]	Adjusts the exposure automatically to prevent large changes in brightness between adjacent frames.	

4 Close the menu.

- Press the shutter button halfway.

5 Start recording.

- Press the shutter button fully.
- When [Start Time Set] is set, the camera will enter into sleep status until the start time is reached.
- During recording standby, the camera enters into sleep status when no operation is performed for a certain period of time.
- The recording will stop automatically.

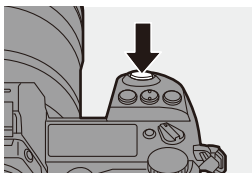

6 Create a video. (→ 151)

- After the recording has stopped, select [Yes] on the confirmation screen to proceed to create a video. Even if you select [No], you can still create a video with [Time Lapse Video] in the [Playback] ([Process Image]) menu. (→ 364)

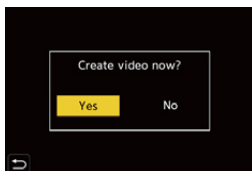

❖ Operations during Time Lapse Shot Recording

Pressing the shutter button halfway during sleep status will turn on the camera.

- You can perform the following operations by pressing [Q] during Time Lapse Shot recording.

[Continue]	Returns to the recording. (Only during recording)
[Pause]	Pauses the recording. (Only during recording)
[Resume]	Resumes the recording. (Only while paused) <ul style="list-style-type: none"> • You can also press the shutter button halfway to resume.
[End]	Stops the Time Lapse Shot recording.



- Pictures recorded to more than one card cannot be combined into a single video.
- Group images containing pictures taken with [HLG Photo] cannot be converted to videos.
- The camera gives priority to achieving the correct exposure, so it may not take pictures at the set interval or take the set number of pictures. Furthermore, it may not end at the end time displayed on the screen.
- Time Lapse Shot is paused in the following cases.
 - When the charge on the battery runs out
 - When you set the camera on/off switch to [OFF]

You can set the camera on/off switch to [OFF] and replace the battery or card.

Set the camera on/off switch to [ON] and then press the shutter button fully to resume recording.

(Note that the images recorded after replacing the card will be saved as a separate set of group images.)
- [Exposure Leveling] is not available in [M] mode if the ISO sensitivity is set to other than [AUTO].
- [Time Lapse Shot] is not available when using the following functions:
 - [High Resolution Mode]
 - [Post-Focus]
 - [Multiple Exposure]

Recording with Stop Motion Animation

iA P A S M 





Take pictures while moving the subject little by little.

The pictures taken will be saved as a set of group images that can be combined into a stop motion video.

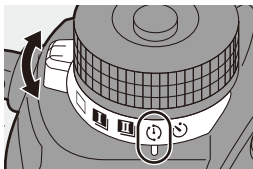
1 Set the drive mode dial to [].



2 Set [Mode] to [Stop Motion Animation].

-  → [] → [] → [Time Lapse/Animation] → [Mode] → [Stop Motion Animation]



3 Set the recording settings.

[Mode]	Switches between Time Lapse Shot and Stop Motion Animation.	
[Add to Picture Group]	Allows you to continue recording for a set of stop motion images that have already been recorded. <ul style="list-style-type: none"> • Select an image and proceed to Step 5. 	
[Auto Shooting]	[ON]	Takes pictures automatically at a set recording interval.
	[OFF]	This is for taking pictures manually, frame by frame.
[Shooting Interval]	Sets the recording interval for [Auto Shooting].	

4 Close the menu.

- Press the shutter button halfway.

5 Start recording.

- Press the shutter button fully.
- Take pictures repeatedly while moving the subject little by little.
- The recording screen displays up to two pictures taken previously. Use them as reference for the amount of movement.
- You can play back the recorded stop motion images by pressing [▶] during recording.

Press [🗑️] to delete unnecessary images.

To return to the recording screen, press [▶] again.

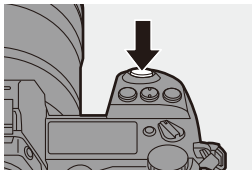

6 Stop recording.

- Press [MENU/SET] and then select [Time Lapse/Animation] from the [Photo] menu to stop recording.



7 Create a video. (→ 151)

- After the recording has stopped, select [Yes] on the confirmation screen to proceed to create a video. Even if you select [No], you can still create a video with [Stop Motion Video] in the [Playback] ([Process Image]) menu. (→ 364)

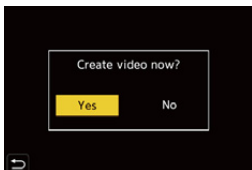



- Group images containing pictures taken with [HLG Photo] cannot be converted to videos.
- Up to 9999 frames can be recorded.
- If the camera is turned off while recording, a message for resuming the recording is displayed when it is turned on. Selecting [Yes] allows you to continue the recording from the interruption point.
- The camera gives priority to achieving the correct exposure, so it may not take pictures at the set interval when the flash, etc. is used for recording.
- A picture cannot be selected from [Add to Picture Group] when it is the only one that was taken.
- [Stop Motion Animation] is not available when using the following functions:
 - [High Resolution Mode]
 - [Post-Focus]
 - [Multiple Exposure]

Time Lapse Shot/Stop Motion Animation Videos

After performing Time Lapse Shot or stop motion recording, you can proceed to create a video.

- Refer to the sections below about these recording functions.
 - Time Lapse Shot recording: → 145
 - Stop motion recording: → 148
- You can also create videos with [Time Lapse Video] (→ 364) or [Stop Motion Video] (→ 364) in the [Playback] menu.

1 Select [Yes] on the confirmation screen that appears after recording.

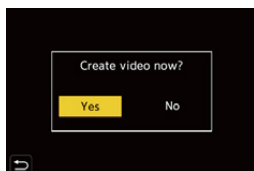

2 Set the options for creating a video.

3 Select [OK].

- A video will be created in the [MP4] recording file format.

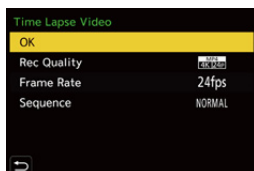

[OK]	Creates a video.	
[Rec Quality]	Sets the video image quality.	
[Frame Rate]	Sets the number of frames per second. The larger the number is, the smoother the video will be.	
[Sequence]	[NORMAL]	Splices pictures together in recording order.
	[REVERSE]	Splices pictures together in reverse recording order.



- Videos cannot be created if the recording time exceeds 29 minutes and 59 seconds.
- In the following cases, videos cannot be created if the file size exceeds 4 GB:
 - When an SDHC memory card or an XQD card of 32 GB or less is being used and the size for [Rec Quality] is set to [4K]
 - When the size for [Rec Quality] is set to [FHD]

Recording Using the Self-timer

iA P A S M 



1 Set the drive mode dial to [📷].

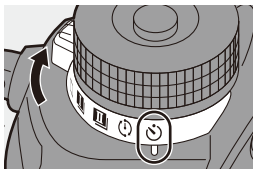

2 Decide on the composition and then adjust the focus.

- Press the shutter button halfway.
- The focus and exposure are fixed when the shutter button is pressed halfway.







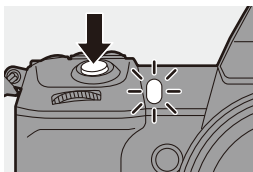

3 Start recording.

- Press the shutter button fully.
- The self-timer lamp blinks and then the shutter is released.



❖ Setting the Self-timer Time

 → [] → [] → Select [Self Timer]

[]	Takes a picture after 10 seconds.
[]	Takes 3 pictures at approx. 2 second intervals after 10 seconds.
[]	<p>Takes a picture after 2 seconds.</p> <ul style="list-style-type: none"> • This setting is a convenient way to avoid camera blur caused by pressing the shutter button.



- We recommend using a tripod when recording with the self-timer.



- When the following functions are being used, [] is not available:
 - [Simultaneous Record w/o Filter] ([Filter Settings])
 - Bracket recording
 - [Multiple Exposure]
- The self-timer does not work while you are using the following functions:
 - [High Resolution Mode]
 - [Post-Focus]

Bracket Recording

iA P A S M 



When the shutter button is pressed, the camera can record multiple images while automatically changing the setting value for exposure, aperture, focus or white balance (adjustment value or color temperature).

-  Aperture Bracket can be selected in the following modes:
 - [A] mode
 - [M] mode (when ISO sensitivity is set to [AUTO])
- White Balance Bracket (Color Temperature) can be selected when the white balance is set to [K1], [K2], [K3], or [K4].

1 Set [Bracketing Type].

-  →  →  →
[Bracketing] → [Bracketing Type]

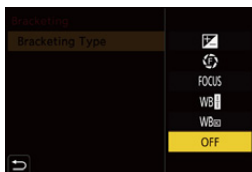

2 Set [More Settings].

- For information about [More Settings], refer to page for each bracketing method.

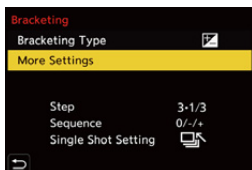



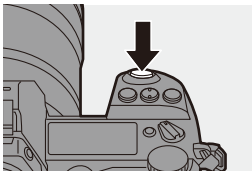

3 Close the menu.

- Press the shutter button halfway.

4 Focus on the subject and then take pictures.



❖ Setting Items ([Bracketing Type])

[] Exposure Bracket	When the shutter button is pressed, the camera records while changing the exposure. (→ 158)
[] Aperture Bracket	When the shutter button is pressed, the camera records while changing the aperture value. (→ 158)
[FOCUS] Focus Bracket	When the shutter button is pressed, the camera records while changing the focus position. (→ 159)
[WB ] White Balance Bracket	When the shutter button is pressed once, the camera automatically records three images with the different white balance adjustment values. (→ 160)
[WB ] White Balance Bracket (Color Temperature)	When the shutter button is pressed once, the camera automatically records three images with the different white balance color temperatures. (→ 160)
[OFF]	—



❖ How to Cancel Bracketing

Select [OFF] in Step 1.



- Only Exposure Bracket is available when [Aspect Ratio] is set to [65:24] or [2:1].
- White Balance Bracket and White Balance Bracket (Color Temperature) are not available when using the following functions:
 - [iA] mode
 - Taking burst pictures
 - [RAW+FINE]/[RAW+STD.]/[RAW] ([Picture Quality])
 - [HLG Photo]
 - [Filter Settings]
- Bracket recording is not available while you are using the following functions:
 - [6K/4K PHOTO]/[Post-Focus]
 - [Time Lapse Shot]
 - [Stop Motion Animation] (when [Auto Shooting] is set)
 - [High Resolution Mode]
 - [Rough Monochrome]/[Silky Monochrome]/[Miniature Effect]/[Soft Focus]/[Star Filter]/[Sunshine] ([Filter Settings])
 - [Multiple Exposure]



- You can register functions to Fn buttons:
 - [] ⇒ [] ⇒ [Fn Button Set] ⇒ [Setting in REC mode] ⇒ [Bracketing]
 - (→ 278)

❖ [More Settings] (Exposure Bracket)

[Step]	Sets the image count and exposure compensation step. [3•1/3] (record 3 images in 1/3 EV steps) to [7•1] (record 7 images in 1 EV steps)
[Sequence]	Sets the order in which images are recorded.
[Single Shot Setting]	<p>[□]: Takes only one image each time the shutter button is pressed.</p> <p>[□/□]: Takes all of the set number of images when the shutter button is pressed once.</p> <ul style="list-style-type: none"> • The bracket indication blinks until all of the set number of pictures is taken. • This cannot be set when taking burst pictures. <p>If you press and hold the shutter button, burst pictures are taken until the set number of images is recorded.</p>



- When you record images with Exposure Bracket after setting the exposure compensation value, the images recorded are based on the selected exposure compensation value.

❖ [More Settings] (Aperture Bracket)

[Image Count]	<p>[3]/[5]: Records the set number of images while alternately setting the aperture value in the sequence of one before and then one after using the initial aperture value as the reference.</p> <p>[ALL]: Records images using all aperture values.</p> <ul style="list-style-type: none"> • If you press and hold the shutter button, burst pictures are taken until the set number of images is recorded.
----------------------	--

Example when the initial position is set to F8.0

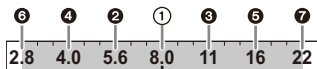

- ① 1st image, ② 2nd image, ③ 3rd image ... ⑦ 7th image

❖ [More Settings] (Focus Bracket)

[Step]	Sets the focus adjustment step. <ul style="list-style-type: none"> The distance that the focus position is moved becomes shorter if the initial focus position is close, and longer if it is far away.
[Image Count]	Sets the image count. <ul style="list-style-type: none"> This cannot be set when taking burst pictures. Burst pictures are taken while the shutter button is pressed.
[Sequence]	<p>[0/-/+]: Records while alternately moving the focus position in the sequence of forward and then backward using the initial focus position as the reference.</p> <p>[0/+]: Records while moving the focus position toward the far side using the initial focus position as the reference.</p>

Example when [Sequence]: [0/-/+] is set

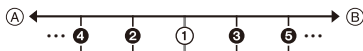

Example when [Sequence]: [0/+] is set



(A) Focus: closer





(B) Focus: more distant

① 1st image, ② 2nd image ... ⑤ 5th image ...



• Pictures recorded with Focus Bracket are displayed as images of one group.

❖ [More Settings] (White Balance Bracket)

Rotate ,  or  to set the correction step and then press  or .





Rotate to the right:

Horizontal direction ([A] to [B])

Rotate to the left:



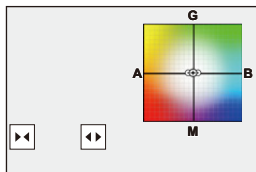

Vertical direction ([G] to [M])

- The correction step can also be set by touching

/ / / .



❖ [More Settings] (White Balance Bracket (Color Temperature))

Rotate ,  or  to set the correction step and then press  or .

- The correction step can also be set by touching

/ .

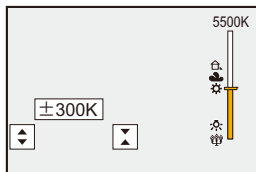

Post-Focus Recording

iA P A S M



Taking burst pictures with the same image quality as 6K/4K photos while automatically changing the focus position.

You can select the focus position for the picture to save after recording. Also Focus Stacking lets you combine images with multiple focus positions.

This function is suitable for subjects that do not move.



Perform burst 6K/4K photo recording while automatically shifting the focus.

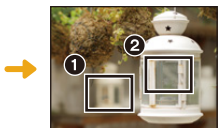

Touch the desired focus point.



A picture with the desired focus point is made.



- Use a card rated at UHS Speed Class 3 or higher when using an SD card for this function.
- The angle of view becomes narrower.
- When performing Focus Stacking, we recommend using a tripod.

1 Set the image quality for [Post-Focus].

- → → → [Post-Focus] → [6K 18M]/[4K 8M]



2 Close the menu.

- Press the shutter button halfway.

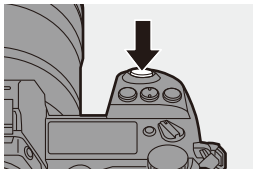

3 Decide on the composition and then adjust the focus.

- Press the shutter button halfway.
- AF detects the focus position on the screen. (Excluding the edges of the screen)

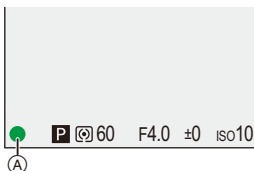

- If no areas on the screen can be brought into focus, the focus indication (A) blinks and recording is not possible.
- Maintain the same distance to the subject and the same composition until recording finishes.

4 Start recording.

- Press the shutter button fully.
- Recording is performed while automatically changing the focus position.
When the icon (B) disappears, recording ends automatically.

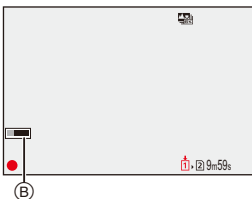

- A video will be recorded with [Rec. File Format] set to [MP4]. (Audio will not be recorded.)
- In default settings, Auto Review operates, and a screen that lets you select the point to be focused will be displayed. (→ 164)

❖ Limitations on Post-Focus Recording

- Since recording is performed with the same image quality as 6K/4K photos, limitations apply to recording functions and menus.
For details, refer to “Camera Settings for 6K/4K Photo” on page 136.
- In addition to the limitations of 6K/4K photos, focus settings cannot be changed during Post-Focus recording.



- If the camera temperature rises under the any of following conditions, [] may be displayed and recording may stop. Wait until the camera cools down.
 - While recording continuously with Post-Focus
 - When the ambient temperature is high
- When using APS-C lenses, [6K 18M] is not available.
- When the following functions are being used, [Post-Focus] is not available:
 - [Time Lapse Shot]
 - [Stop Motion Animation]
 - [High Resolution Mode]
 - [Rough Monochrome]/[Silky Monochrome]/[Miniature Effect]/[Soft Focus]/[Star Filter]/[Sunshine] ([Filter Settings])
 - [Multiple Exposure]



- You can register functions to Fn buttons:
[] ⇒ [] ⇒ [Fn Button Set] ⇒ [Setting in REC mode] ⇒ [Post-Focus]
(→ 278)

Selecting the Focus Position for the Picture to Save

1 Select a Post-Focus image on the playback screen. (→ 259)

- Select an image with the [▲] icon and then press ▲.
- You can also perform the same operation by touching the [▲] icon.



2 Touch the point to be brought into focus.











- When the point is in focus, a green frame appears.
- If there is no picture with the selected point in focus, a red frame appears. A picture cannot be saved.
- The edge of the screen cannot be selected.

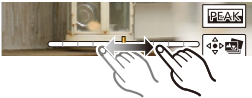

3 Save the picture.

- Touch [◀▶].
- The picture is saved in JPEG format.

❖ Focus Position Selection Operations

Button operation	Touch operation	Description of operation
▲▼◀▶ / ☀ / ⚙	Touch	<p>Selects a focus position.</p> <ul style="list-style-type: none"> Selection is not possible during enlarged display.
		<p>Enlarges the display.</p> <ul style="list-style-type: none"> During enlarged display, you can fine-adjust the focus by dragging the slide bar. (You can also perform the same operation by pressing ◀▶.) 
		Reduces the display (during enlarged display).
[]		Switches to Focus Stacking operation. (→ 166)
—		<p>Displays the in-focus portion highlighted with color ([Focus Peaking]).</p> <ul style="list-style-type: none"> Switches in the order of [OFF] → [ON].
 / 		Saves the picture.



- You cannot display an image on a TV screen and then select the focus position.

Focus Stacking

Save a picture with multiple focus positions merged.



(A)

(A) Focus: closer

(B) Focus: more distant

- 1 On the screen for selecting the focus position in Step 2 on page 164, touch [].

- You can also perform the same operation by pressing [].

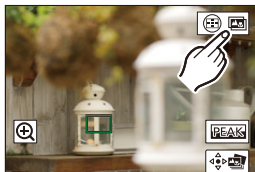

- 2 Select the merging method.

[Auto Merging]	Automatically selects pictures suitable for merging and then merges them into a single picture.
[Range Merging]	Merges pictures with selected focus positions into a single picture.

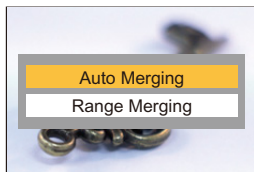



3 (When [Range Merging] is selected)

Touch the points to be brought into focus.

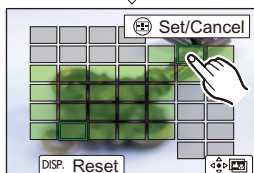
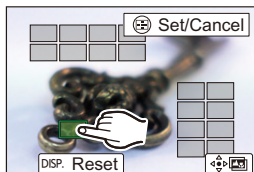
- Select at least two points.
Selected points are indicated with a green frame.
- The in-focus range between the two selected points is displayed in green.
- Ranges that cannot be selected are displayed in gray.
- To cancel the selection, touch a point with a green frame again.
- To select consecutive points, drag the screen.



4 Save the picture.

- Touch [ ].

❖ Operations when [Range Merging] is Selected

Button operation	Touch operation	Description of operation
	Touch	Selects a point.
[]	[Set/Cancel]	Sets or cancels a point.
[DISP.]	[All]	Selects all points. (Before selecting points)
	[Reset]	Cancels all selections. (After selecting points)
		Merges the pictures and saves the resulting picture.



- The picture is saved in JPEG format, and the recording information (Exif information), such as the shutter speed, aperture, and ISO sensitivity, of the picture with the closest point is also saved with the picture that is saved.
- Image misalignment due to camera shake will be adjusted automatically. If adjustments are made, the angle of view will become slightly narrower when the pictures are merged.
- If the subject moves during recording or the distance between subjects is great, merging may create an unnatural picture.
- Focus Stacking may not be available for images recorded with other than this camera.





[Silent Mode]

iA P A S M 



This disables all operation sounds and light output at once.

The audio from the speaker will be muted and the flash and the AF assist lamp will be set to forced off mode.

- The following settings are fixed:
 - [Flash Mode]: [] (Forced Flash Off)
 - [AF Assist Light]: [OFF]
 - [Shutter Type]: [ELEC.]
 - [Beep Volume]: [] (OFF)
 - [AF Beep Volume]: [] (OFF)
 - [E-Shutter Vol]: [] (OFF)



 ⇒ [] ⇒ [] ⇒ Select [Silent Mode]

Settings: [ON]/[OFF]



- Even when [ON] is set, the following function lights/blinks:
 - Card access lamp
 - Self-timer lamp
 - Status LCD Backlight
 - Illumination button
- Use this function at your own responsibility sufficiently considering the privacy, portrait, and other rights of subjects.



- You can register functions to Fn buttons:
 - [] ⇒ [] ⇒ [Fn Button Set] ⇒ [Setting in REC mode] ⇒ [Silent Mode] (→ 278)

[Shutter Type]

iA P A S M 



Select the shutter type to use for taking pictures.

 → [] → [] → Select [Shutter Type]

[AUTO]	Switches the shutter type automatically depending on the recording conditions and shutter speed.
[MECH.]	Records with the mechanical shutter type.
[EFC]	Records with the electronic front curtain type.
[ELEC.]	Records with the electronic shutter type.
[ELEC.+NR]	Records with the electronic shutter type. When pictures are taken at slower shutter speeds, the shutter is closed after recording to perform long shutter noise reduction. <ul style="list-style-type: none"> • The next picture cannot be taken during long shutter noise removal.

	Mechanical shutter type	Electronic front curtain type	Electronic shutter type
Mechanism	This type starts and ends exposure with the mechanical shutter.	This type starts exposure electronically and ends it with the mechanical shutter.	This type starts and ends exposure electronically.
Flash	✓	✓	—
Shutter speed (sec.)	[B] (Bulb, max. approx. 30 minutes) ^{*1} , 60 to 1/8000	[B] (Bulb, max. approx. 30 minutes) ^{*1} , 60 to 1/2000	[B] (Bulb, max. approx. 60 seconds) ^{*1} , 60 to 1/16000
Shutter sound	Mechanical shutter sound	Mechanical shutter sound	Electronic shutter sound ^{*2}

*1 This setting is available only in [M] mode.

*2 The electronic shutter sound can be set in [E-Shutter Vol] and [E-Shutter Tone] in [Beep] of the [Setup] ([IN/OUT]) menu. (→ 354)

- The electronic front curtain type reduces blur caused by the shutter because the amount of vibration from the shutter is small compared to the mechanical shutter type.
- The electronic shutter type allows you to record without vibration from the shutter.



- When [E] is displayed on the screen, recording will be with the electronic shutter type.
- When a moving subject is recorded using the electronic shutter, the subject may appear distorted in the picture.
- When you record using the electronic shutter under lighting such as fluorescent or LED lighting, horizontal stripes may be recorded. In such a case, lowering the shutter speed may reduce the effect of horizontal stripes.
- When [Silent Mode] is being used, [Shutter Type] is fixed to [ELEC.].
- When using APS-C lenses, [EFC] is not available.







- You can register functions to Fn buttons:
[] ⇒ [] ⇒ [Fn Button Set] ⇒ [Setting in REC mode] ⇒ [Shutter Type]
(→ 278)

Image Stabilizer

iA P A S M 







The camera can use both the in-body image stabilizer and the in-lens image stabilizer.

Of the Dual I.S. modes that effectively combine two image stabilizers, this supports Dual I.S.2 ( , ) with high correction efficiency.

Furthermore, during video recording, you can use the 5-Axis Hybrid Image Stabilizer that incorporates electronic stabilization.

Available image stabilizers (As of January 2019)

Image stabilizers that can be used will differ depending on the attached lens.

Attached lens	Available image stabilizer	Example of screen display
Panasonic lenses with image stabilization function	Body+Lens (Dual I.S.2)	DUAL2 
Other manufacturer's lenses with image stabilization function	Body or Lens	BODY / LENS 
Lenses without image stabilizer	Body	BODY 
Lenses without communication function	Body	BODY 

- The 5-Axis Hybrid Image Stabilizer can be used with any lenses.

❖ Using the Image Stabilizer

- When using a lens with an O.I.S. switch, set it to [ON].
- When using lenses without a function for communicating with this camera, a message asking you to check the focal length setting is displayed after you turn on the camera.

Correctly operating the image stabilization function requires that the focal length be set to match the attached lens.

Set the focal length in accordance as prompted by the message.

This can also be set using the menu. (→ [174](#))



- When the shutter button is pressed halfway, the camera shake alert icon [([📷])] may be displayed on the recording screen. If this is displayed, we recommend using a tripod, the self timer or the Shutter Remote Control (DMW-RS2: optional).
- We recommend turning off the image stabilizer function when using a tripod.



- The image stabilizer may cause vibration or produce operational sound during operation, but these are not malfunctions.
- When the following function is being used, the image stabilizer function is not available:
 - [High Resolution Mode]







- You can display the reference point and check the camera shake status: [⚙️] → [📷] → [I.S. Status Scope] (→ [348](#))

Image Stabilizer Settings

Set the image stabilizer movement to match the recording situation.



 ⇒  ⇒  ⇒ Select [Image Stabilizer]

[Operation Mode]	Sets the stabilization movement (blur) to match the recording method (normal, panning). (→ 175)	
[Body(B.I.S.) / Lens(O.I.S.)]	<small>BODY</small>  ([Body])	Uses the in-body image stabilizer.
	<small>LENS</small>  ([Lens])	Uses the in-lens image stabilizer.
	<ul style="list-style-type: none"> • This can be set when using other manufacturer's lenses with an image stabilization function. 	
[When to Activate]	[ALWAYS]	The image stabilizer is always operating.
	[HALF-SHUTTER]	The image stabilizer operates when the shutter button is pressed halfway.
[E-Stabilization (Video)]	<p>Camera shake during video recording is corrected along the vertical, horizontal, roll, pitch, and yaw axes through the combined use of the in-lens, in-body, and electronic stabilizers. (5-Axis Hybrid Stabilizer)</p> <ul style="list-style-type: none"> • When [E-Stabilization (Video)] is operating,  or  is displayed on the recording screen. • The angle of view may become narrower if set to [ON]. 	
[Boost I.S. (Video)]	<p>Increases the effectiveness of the image stabilizer during video recording.</p> <p>This effect can help provide a stable composition when you want to perform recording from a fixed perspective. (→ 176)</p>	
[Focal Length Set]	<p>When using lenses without a function for communicating with this camera, manually set the focal length. (→ 177)</p>	







- When the following functions are being used, [When to Activate] is fixed to [ALWAYS]:
 - [] ([Body(B.I.S.) / Lens(O.I.S.)])
 - Video recording/[6K/4K PHOTO]/[Post-Focus]
- When the following function is being used, [E-Stabilization (Video)] is not available:
 - [High Speed Video]





- You can register functions to Fn buttons:
 - [] ⇒ [] ⇒ [Fn Button Set] ⇒ [Setting in REC mode] ⇒ [E-Stabilization (Video)] (→ 278)

❖ [Operation Mode]



Set the stabilization movement (blur) to match the recording method (normal, panning).

 [Normal]	Corrects vertical, horizontal, and rotational camera shake. This function is suitable for normal recording.
 [Panning (Auto)]	Automatically detects the panning direction, and corrects vertical and horizontal camera shake. This function is suitable for panning.
 [Panning (Left/Right)]	Corrects vertical camera shake. This is suitable for horizontal panning.
 [Panning (Up/Down)]	Corrects horizontal camera shake. This is suitable for vertical panning.
[OFF]	Turns the image stabilization function OFF.

- Operation modes that can be used will differ depending on the used lenses and on [Body(B.I.S.) / Lens(O.I.S.)] settings.
- [Panning (Auto)] is not displayed when using other manufacturer's lenses with an image stabilization function with [Body(B.I.S.) / Lens(O.I.S.)] set to []. Set to either [Panning (Left/Right)] or [Panning (Up/Down)] to suit the panning direction.
- When using lenses with an O.I.S. switch, the camera's operation mode cannot be set to [OFF].
- When the following functions are being used, [Operation Mode] switches to [] ([Normal]):
 - Video recording/[6K/4K PHOTO]/[Post-Focus]



- You can register functions to Fn buttons:

[] ⇒ [] ⇒ [Fn Button Set] ⇒ [Setting in REC mode] ⇒ [Image Stabilizer] (→ [278](#))

❖ [Boost I.S. (Video)]

Increase the effectiveness of the image stabilizer during video recording.

This effect can help provide a stable composition when you want to perform recording from a fixed perspective.

Settings: [ON]/[OFF]

- When [Boost I.S. (Video)] is operating, [] is displayed on the recording screen.
- To change composition while recording, first set this to [OFF] before moving the camera.
To set this to [OFF] during recording, use the Fn button. (→ [278](#))
- Longer focal lengths will result in weaker stabilization.





- When [Body(B.I.S.) / Lens(O.I.S.)] is set to [], [Boost I.S. (Video)] is not available.

❖ [Focal Length Set]

When using lenses without a function for communicating with this camera, manually set the focal length inscribed on the lens.

Up to three focal length settings can be registered.

Registered focal length settings can be called.

Entering focal length input (A)	Enter the focal length. ◀▶: Select ▲▼: Select a numeric value. MENU/SET or  : Confirm • 0.1 mm to 1000 mm can be set.
Registration and calling (B)	Register the entered focal length. Call the registered focal length. ▶◀: Select [DISP.]: Register the entered focal length. MENU/SET or  : Call the registered focal length.

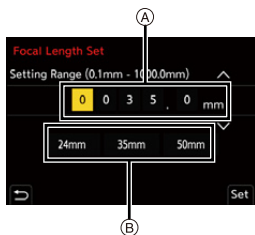

8. Metering/Exposure/ISO Sensitivity





[Metering Mode]





iA P A S M 

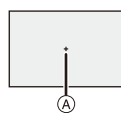

Type of optical measurement to measure brightness can be changed.

 → [] → [] → Select [Metering Mode]

 (Multi-metering)	Method in which the most suitable exposure is measured by judging the allocation of brightness on the whole screen.
 (Center-weighted)	Method used to perform measuring which focuses on the center of the screen.
 (Spot)	Method used to measure the extremely small part around the spot-metering target (A). 
 (Highlight-weighted)	Method used to perform measuring which focuses on the highlighted parts of the screen to prevent overexposure. This is suitable for theatre photography, etc.

- ➔ You can register functions to Fn buttons:
[] → [] → [Fn Button Set] → [Setting in REC mode] → [Metering Mode] (→ 278)
- The standard value for correct exposure can be adjusted:
[] → [] → [Exposure Offset Adjust.] (→ 328)

Program AE Mode

iA **P** A S M 



In [P] mode (Program AE mode), the camera automatically sets the shutter speed and aperture value for the brightness of the subject.

You can also use Program Shift to change combinations of shutter speed and aperture values while keeping the same exposure.

1 Set the mode dial to [P].

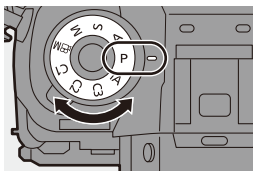

2 Press the shutter button halfway.

- This displays the aperture value (A) and shutter speed value (B) on the recording screen.
- If the correct exposure is not achieved, the aperture value and shutter speed blink red.

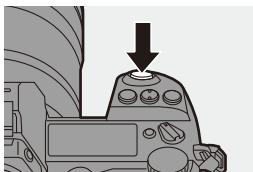

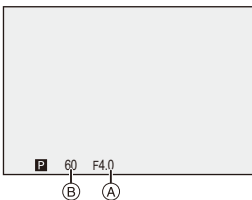

3 Start recording.





❖ Program Shift

You can change the shutter speed and aperture value combination set automatically by the camera while maintaining the same exposure. With this, you can, for example, make the background more defocused by decreasing the aperture value or capture a moving subject more dynamically by slowing the shutter speed.

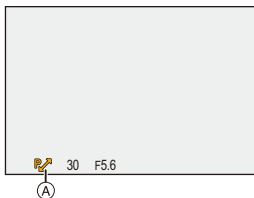
- ❶ Press the shutter button halfway.
 - This displays the aperture value and shutter speed value on the recording screen. (Approx. 10 seconds)
- ❷ Rotate  or  while the values are displayed.
 - This displays the Program Shift icon (A) on the recording screen.
- ❸ Start recording.







Canceling Program Shift

- Set the camera on/off switch to [OFF].
- Rotate  or  until the Program Shift icon disappears.



- Program Shift is not available when using the following functions:
 - Flash
 - [6K/4K PHOTO]/[Post-Focus]



- You can customize dial operations:
 - [] ⇒ [] ⇒ [Dial Set.] ⇒ [Assign Dial (F/SS)] (→ 336)
- The recording screen can display an exposure meter indicating the relationship between aperture value and shutter speed:
 - [] ⇒ [] ⇒ [Expo.Meter] (→ 344)

Aperture-Priority AE Mode

iA P **A** S M 



In [A] mode (Aperture-Priority AE mode), you can set the aperture value before recording.

The shutter speed will be automatically set by the camera.



Smaller aperture values

It becomes easier to defocus the background.



Larger aperture values

It becomes easier to bring everything into focus including the background.

1 Set the mode dial to [A].

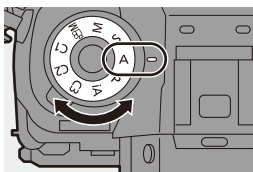

2 Set the aperture value.

- Rotate  or .

3 Start recording.

- If the correct exposure is not achieved when the shutter button is pressed halfway, the aperture value and the shutter speed blink red.

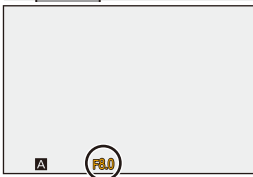
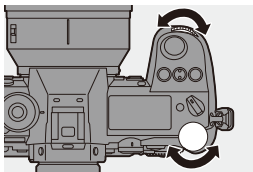

❖ Depth of Field Characteristics

*1	Aperture value	Small	Large
	Focal length of lens	Tele	Wide
	Distance to subject	Near	More distant
Depth of field (area in sharp focus)		Shallow (narrow) Example: When you want to take a image with a defocused background.	Deep (wide) Example: When you want to take a image with focus as far as the background.

*1 Recording conditions



- The effects of the set aperture value and shutter speed will not be visible on the recording screen.
To check the effects on the recording screen, use [Preview]. (→ 188)
- The brightness of the recording screen and of actual recorded images may differ.
Check the images on the playback screen.
- When using a lens with an aperture ring, set the position of the aperture ring to other than [A] to use the aperture value of the lens.



- You can customize dial operations:
[⚙] ⇒ [🌅] ⇒ [Dial Set.] ⇒ [Rotation (F/SS)] (→ 336)
- The recording screen can display an exposure meter indicating the relationship between aperture value and shutter speed:
[⚙] ⇒ [📷] ⇒ [Expo.Meter] (→ 344)

Shutter-Priority AE Mode

iA P A **S** M 



In [S] mode (Shutter-Priority AE mode), you can set the shutter speed before recording.

The aperture value will be automatically set by the camera.



Slower shutter speeds

It becomes easier to capture motion



Faster shutter speeds

It becomes easier to freeze motion

1 Set the mode dial to [S].

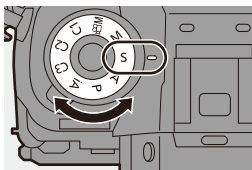

2 Set the shutter speed.

- Rotate  or .

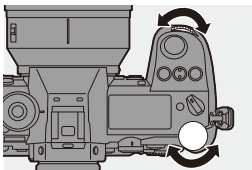

3 Start recording.

- If the correct exposure is not achieved when the shutter button is pressed halfway, the aperture value and the shutter speed blink red.

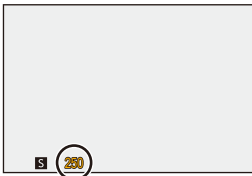



- The effects of the set aperture value and shutter speed will not be visible on the recording screen.

To check the effects on the recording screen, use [Preview]. (→ 188)

- The brightness of the recording screen and of actual recorded images may differ.

Check the images on the playback screen.



- Shutter speeds faster than 1/320 of a second are not available when you fire the flash. (→ 222)



- You can customize dial operations:

[] ⇒ [] ⇒ [Dial Set.] ⇒ [Assign Dial (F/SS)]/[Rotation (F/SS)] (→ 336)

- The recording screen can display an exposure meter indicating the relationship between aperture value and shutter speed:

[] ⇒ [] ⇒ [Expo.Meter] (→ 344)

Manual Exposure Mode

iA P A S **M** 



In [M] mode (Manual Exposure mode), you can take pictures by manually setting the aperture value and shutter speed.

In default settings, the ISO sensitivity is set to [AUTO].



As a result, the ISO sensitivity will be adjusted according to the aperture value and shutter speed.

Exposure compensation can also be used when ISO sensitivity is set to [AUTO].

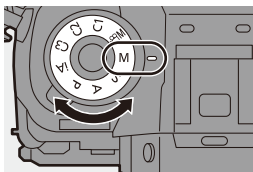
1 Set the mode dial to [M].



2 Set the aperture value and shutter speed.

- Rotate  to set the aperture value, and  to set the shutter speed.

- (A) Aperture value
- (B) Shutter speed

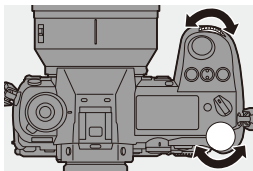

3 Start recording.

- If the correct exposure is not achieved when the shutter button is pressed halfway, the aperture value and the shutter speed blink red.

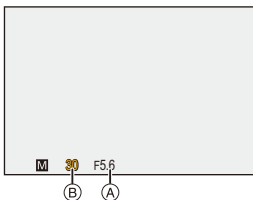

❖ Available Shutter Speeds (Sec.)

[MECH.]	[B] (Bulb, max. approx. 30 minutes), 60 to 1/8000
[EFC]	[B] (Bulb, max. approx. 30 minutes), 60 to 1/2000
[ELEC.]	[B] (Bulb, max. approx. 60 seconds), 60 to 1/16000



- The effects of the set aperture value and shutter speed will not be visible on the recording screen.

To check the effects on the recording screen, use [Preview]. (→ 188)

You can set the preview mode to operate constantly in [M] mode.

[] → [] → [Constant Preview] (→ 339)

- The brightness of the recording screen and of actual recorded images may differ.
Check the images on the playback screen.
- When using a lens with an aperture ring, set the position of the aperture ring to other than [A] to use the aperture value of the lens.
- Shutter speeds faster than 1/320 of a second are not available when you fire the flash. (→ 222)



- You can customize dial operations:

[] → [] → [Dial Set.] → [Assign Dial (F/SS)]/[Rotation (F/SS)] (→ 336)

- The recording screen can display an exposure meter indicating the relationship between aperture value and shutter speed:

[] → [] → [Expo.Meter] (→ 344)

❖ Manual Exposure Assist

When ISO sensitivity is set to other than [AUTO], Manual Exposure Assist (example: +1) will be displayed on the recording screen.

You can check the difference between the current exposure value and the correct exposure (± 0) measured by the camera.

- Use Manual Exposure Assist as a guide.

We recommend checking the images on the playback screen when recording.

❖ [B] (Bulb)

If you set the shutter speed to [B] (Bulb), the shutter stays open while the shutter button is pressed fully. (up to approx. 30 minutes)

The shutter closes when the shutter button is released.

Use this when you want to keep the shutter open for a long time to record images of fireworks, night scenery or a starry sky.



- We recommend using a tripod or the Shutter Remote Control (DMW-RS2: optional) during bulb recording.
- Bulb recording may create noticeable noise.
If you are concerned about noise, we recommend that you set [Long Exposure NR] to [ON] in the [Photo] ([Image Quality]) menu before recording.



- Bulb is not available when using the following functions:
 - [6K/4K PHOTO]/[Post-Focus]
 - [Time Lapse Shot]
 - [Stop Motion Animation] (when set to [Auto Shooting])
 - [Bracketing]
 - [High Resolution Mode]

Preview Mode



You can check the effects of aperture on the recording screen by physically closing the aperture blades of the lens to the aperture value set for actual recording.

In addition to the effects of aperture, you can check the effects of shutter speed at the same time.

- Use the Fn button registered with [Preview] to operate. In default settings, this is registered in [Fn2].

For information about the Fn button, refer to page [278](#).

Press the preview button.

- Each press of the button switches between the effect preview screens.

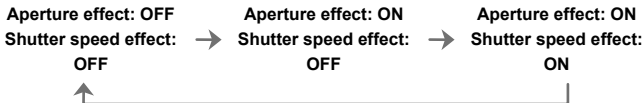
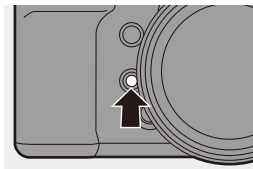

- It is possible to record in preview mode.
- Range for shutter speed effect check is 8 seconds to 1/16000 of a second.
- Preview mode is not available when recording with [6K/4K Pre-Burst].

Exposure Compensation





iA P A S M 



You can compensate the exposure when the correct exposure determined by the camera is too bright or too dark.

You can adjust the exposure in 1/3 EV steps in a range of ± 5 EV.

When recording videos or recording with 6K/4K Photo or Post-Focus, the range changes to ± 3 EV.

- 1 Press [].
- 2 Compensate the exposure.
 - Rotate [], [], or [].

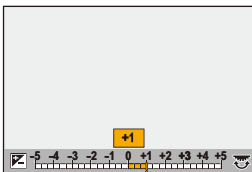
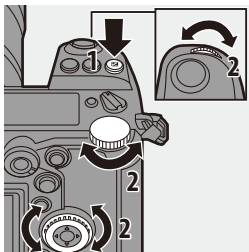

- 3 Confirm your selection.
 - Press the shutter button halfway.

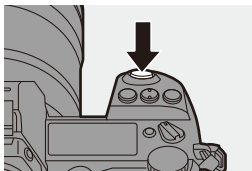



- In [M] mode, you can compensate the exposure by setting the ISO sensitivity to [AUTO].
- When [Auto Exposure Comp.] is set to [ON], the flash output will automatically be set to the level appropriate to the exposure compensation.
- When the exposure compensation value falls below or exceeds ± 3 EV, the brightness of the recording screen will no longer change.
Press the shutter button halfway or use AE Lock to reflect the value on the recording screen.
- When the exposure compensation value falls below or exceeds the ± 3 EV range, exposure compensation values on the status LCD are indicated with [◀]/[▶]. (→ 30)
- The set exposure compensation value is stored even if you turn off the camera. (When [Exposure Comp. Reset] is set to [OFF])



- The standard value for correct exposure can be adjusted:
[⚙️] → [📷] → [Exposure Offset Adjust.] (→ 328)
- You can set the exposure compensation value to be reset when the camera is turned off:
[⚙️] → [📷] → [Exposure Comp. Reset] (→ 328)
- You can change the operation of the [📷] button:
[⚙️] → [🌅] → [WB/ISO/Expo. Button] (→ 335)
- Exposure Bracket can be set and flash output can be adjusted on the exposure compensation screen:
[⚙️] → [🌅] → [Exposure Comp. Disp. Setting] (→ 335)

Locking Focus and Exposure (AF/AE Lock)



Lock the focus and exposure in advance to take pictures with the same focus and exposure settings while changing the composition.

This is useful when you want to bring an edge of the screen into focus or there is a backlight, for example.

1 Register [AE LOCK], [AF LOCK], or [AF/AE LOCK] to the Fn button. (→ 278)

- These cannot be registered to [Fn3] to [Fn7].

[AE LOCK]	The exposure is locked.
[AF LOCK]	The focus is locked.
[AF/AE LOCK]	Both focus and exposure are locked.

2 Lock focus and exposure.

- Press and hold the Fn button.
- If focus is locked, then the AF lock icon (A) will be displayed.
- If exposure is locked, then the AE lock icon (B) will be displayed.

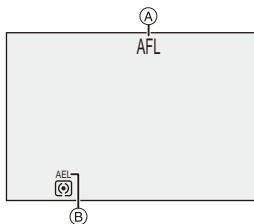

3 Hold the Fn button to decide on the composition and then perform recording.

- Press the shutter button fully.



- Program Shift can be set even when AE is locked.



- You can maintain lock even without pressing and holding the Fn button:
[⚙️] → [AF] → [AF/AE Lock Hold] (→ 329)

Setting the ISO Sensitivity



iA P A S M 



You can set light sensitivity (ISO sensitivity).

With the default settings, you can set ISO100 to 25600 in 1/3 EV increments.

The range that can be set will differ depending on the functions used.

- 1 Press [ISO].**
- 2 Select ISO sensitivity.**
 - Rotate  ,  , or  .
 - Selection is also possible by pressing [ISO].

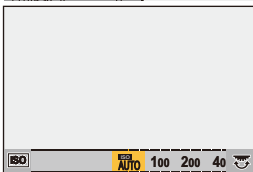
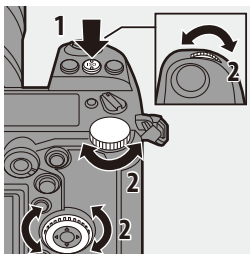

- 3 Confirm your selection.**
 - Press the shutter button halfway.

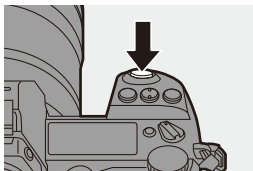

Characteristics of the ISO Sensitivity

Higher ISO sensitivities enable faster shutter speeds even in dark places, so camera shake and subject blur can be prevented. However, higher ISO sensitivities also increase the amount of noise in the recorded images.

❖ Setting Items (ISO Sensitivity)

[AUTO]	<p>The ISO sensitivity is automatically adjusted according to the brightness.</p> <p>Confirm ISO sensitivity by pressing the shutter button halfway.</p> <ul style="list-style-type: none"> • Taking picture: Maximum [ISO6400]^{*1} • Video recording: Maximum [ISO6400]^{*2}
[100] to [25600]	<p>The ISO sensitivity is fixed at the selected value.</p> <ul style="list-style-type: none"> • You can extend the ISO sensitivity range in between a lower limit of L.50 and an upper limit of H.51200 by setting [Extended ISO] (→ 327) to [ON] in the [Custom] ([Image Quality]) menu.

*1 Default setting. The upper limit can be changed with [ISO Sensitivity (photo)].

*2 Default setting. The upper limit can be changed with [ISO Sensitivity (video)].

- When the following functions are being used, the ISO sensitivity that can be set is restricted.
 - [High Resolution Mode]: Up to an upper limit of [ISO3200]
 - [Filter Settings]: Down to a lower limit of [ISO100], up to an upper limit of [ISO6400] (The lower limit changes to [ISO400] when [High Dynamic] is set.)
 - [Multiple Exposure]: Down to a lower limit of [ISO100], up to an upper limit of [ISO6400]
 - [Like709] ([Photo Style]): Down to a lower limit of [ISO100]
 - [Standard(HLG)]/[Monochrome(HLG)] in [Photo Style]: Down to a lower limit of [ISO320]

- ➔ • You can set upper and lower limits for ISO auto when taking pictures:
 - [📷] → [📷] → [ISO Sensitivity (photo)] (→ 306)
 - [👤] → [📷] → [ISO Sensitivity (video)] (→ 319)
- You can change the intervals between ISO sensitivity settings values:
 - [⚙️] → [📷] → [ISO Increments] (→ 327)
- You can change the operation of the [ISO] button:
 - [⚙️] → [🌅] → [WB/ISO/Expo. Button] (→ 335)
- You can set the upper limit for ISO auto on the ISO sensitivity settings screen:
 - [⚙️] → [🌅] → [ISO Displayed Setting] (→ 335)

9. White Balance/Image Quality

Setting the White Balance (WB)

iA P A S M 





White balance (WB) is a function that corrects the color cast produced by the light illuminating the subject.

It corrects the colors so that white objects appear in white to make the overall color closer to what is seen by the eye.

Normally, you can use auto ([AWB], [AWBc] or [AWBw]) to obtain the optimal white balance.

Set this function when the coloring of the image is different from what you expected, or you want to change the coloring to capture the ambience.

- 1 Press [WB].
- 2 Select the white balance.
 - Rotate ,  or .
 - Selection is also possible by pressing [WB].

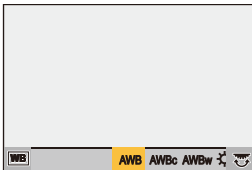
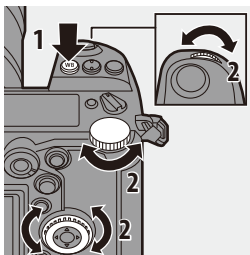

3 Confirm your selection.

- Press the shutter button halfway.

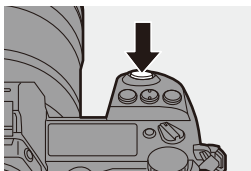

❖ Setting Items (White Balance)

[AWB]	Auto
[AWBc]	Auto (Reduces the reddish hue under an incandescent light source)
[AWBw]	Auto (Leaves the reddish hue under an incandescent light source)
[☀]	Clear sky
[☁]	Cloudy sky
[🏠]	Shade under a clear sky
[💡]	Incandescent light
[📷WB]*	Flash
[1] to [4]	White sets 1 to 4 (→ 197)
[K1] to [K4]	Color temperatures 1 to 4 (→ 197)

- * It operates as [AWB] during video recording or when recording with [6K/4K PHOTO] or [Post-Focus].

1 [AWB] will work within this range.

2 Blue sky

3 Cloudy sky (Rain)

4 Shade

5 Sunlight

6 White fluorescent light

7 Incandescent light bulb

8 Sunrise and sunset

9 Candlelight

K=Kelvin Color Temperature

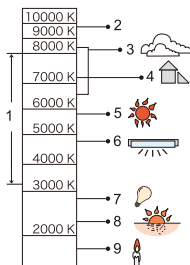

- Under fluorescent lighting, LED lighting fixture, etc., the appropriate white balance will vary depending on the lighting type.



Use [AWB], [AWBc], [AWBw] or [] to [].



- The white balance is fixed to [AWB] while [Filter Settings] is being used.



- The white balance setting items can be registered to Fn buttons:



[] ⇒ [] ⇒ [Fn Button Set] ⇒ [Setting in REC mode] ⇒ [White Balance] (→ 278)

- You can change the operation of the [WB] button:

[] ⇒ [] ⇒ [WB/ISO/Expo. Button] (→ 335)





❖ White Sets ([**1**] to [**4**])

Take pictures of a white object under the light source of the recording location to adjust the white balance until it appears white.

- ❶ Press [WB] and then select any value from [**1**] to [**4**].
- ❷ Press ▲.
- ❸ Aim the camera at a white object so that it appears inside the frame at the center of the screen and then press  or .
 - This will set the white balance and return you to the recording screen.

❖ Color Temperatures ([**K1**] to [**K4**])

Set the numeric value for the white balance color temperature.

- ❶ Press [WB] and then select any value from [**K1**] to [**K4**].
- ❷ Press ▲.
 - The color temperature setting screen is displayed.
- ❸ Press ▲▼ to select the color temperature and then press  or .
 - You can set the White Balance Bracket (Color Temperature) by rotating ,  or . (→ 160)



- You can set a color temperature from [2500K] to [10000K].

Adjusting the White Balance

You can adjust the coloring even when the coloring you want to apply is not produced by the selected white balance.

- ❶ Press [WB].

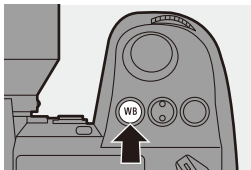





2 Select the white balance and then press ▼.

- The adjustment screen is displayed.

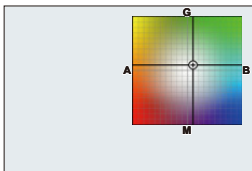
3 Adjust the coloring.

- ◀: [A] (AMBER: ORANGE)
- ▲: [G] (GREEN: GREENISH)
- ▶: [B] (BLUE: BLUISH)
- ▼: [M] (MAGENTA: REDDISH)



- You can also make adjustments in diagonal directions by using the joystick.
 - You can also touch the graph to make adjustments.
 - Press [DISP.] to return to the unadjusted state.
 - You can set the White Balance Bracket by rotating ,  or .
- (→ 160)

4 Confirm your selection.

- Press the shutter button halfway.

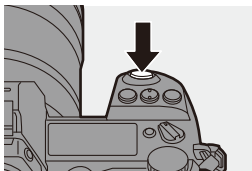

- When the white balance is adjusted, the color of its recording screen icon changes to the adjusted color. Adjusting toward the [G] side will display [+], while adjusting toward the [M] side will display [-].

[Photo Style]











iA P A S M 







You can select the finishing settings of images to suit your subjects and expression styles.

The image quality can be adjusted for each Photo Style.

 → [] → [] → Select [Photo Style]

 STD. [Standard]	The standard setting.
 VIVID [Vivid]	A setting that produces a more vivid quality with higher saturation and contrast.
 NAT [Natural]	A setting that produces a softer quality with lower contrast.
 FLAT [Flat]	A setting that produces a flatter image quality with lower saturation and contrast.
 LAND [Landscape]	A setting suited for sceneries with vivid blue skies and greens.
 PORT [Portrait]	A setting suited for portraits with a healthy and beautiful skin tone.
 MONO [Monochrome]	A monochrome setting with no color shades.
 L.MONO [L.Monochrome]	A black-and-white setting with rich gradation and crisp black accents.
 L.MONO D [L.Monochrome D]	A monochrome setting that creates a dynamic impression with enhanced highlights and shadows.
 CNED [Cinelike D]	A setting that creates a film-like finishing touch using a gamma curve and gives priority to the dynamic range. <ul style="list-style-type: none"> • This function is suitable for video editing processes.
 CNEV [Cinelike V]	A setting that creates a film-like finishing touch using a gamma curve that gives priority to the contrast.

 [Like709]	<p>A setting that minimizes overexposure by applying a gamma curve correction equivalent to Rec.709 to perform compression (knee adjustment) of high-luminance areas.</p> <ul style="list-style-type: none"> Rec.709 is an abbreviation of "ITU-R Recommendation BT.709", a standard for high-definition broadcasting.
 [Standard(HLG)]*1	<p>A setting used to record [HLG Photo].</p>
 [Monochrome(HLG)]*1	<p>A setting used to record [HLG Photo] in monochrome.</p>
 [MY PHOTO STYLE 1] to [MY PHOTO STYLE 10]*2	<p>Adjusts the image quality of Photo Style items to your preferred settings and registers these as My Photo Style items. (→ 203)</p>





*1 When [HLG Photo] is set, only this item can be selected.

*2 Effects up to [MY PHOTO STYLE 4] are displayed with the default settings. You can set the items to display in the menu with [Show/Hide Photo Style] in [Photo Style Settings]. (→ 327)





- In [iA] mode, operation differs from that in other recording modes.
 - [Standard] or [Monochrome] can be set.
 - The setting will be reset to [Standard] when the camera is switched to another recording mode or it is turned off.
 - Image quality cannot be adjusted.
- When [Filter Settings] is being used, [Photo Style] is not available.







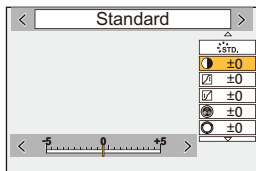

- You can register functions to Fn buttons:
 - [] → [] → [Fn Button Set] → [Setting in REC mode] → [Photo Style] (→ 278)
- You can make detailed Photo Style settings:
 - [] → [] → [Photo Style Settings] (→ 327)



❖ Adjusting the Image Quality

- 1 Press ◀▶ to select the type of Photo Style.
- 2 Press ▲▼ to select an item and then press ◀▶ to adjust.
 - Adjusted items are indicated with [*].
- 3 Press  or .
 - When the image quality is adjusted, the Photo Style icon on the recording screen is indicated with [*].



Settings Items (Picture Mode)

	[Contrast]*¹	Adjusts the contrast in the image.
	[Highlight]*¹	Adjusts the brightness of bright areas.
	[Shadow]*¹	Adjusts the brightness of dark areas.
	[Saturation]*²	Adjusts the vividness of colors.
	[Color Tone]*³	Adjusts blue and yellow tints.
	[Hue]*²	Assuming that the reference point is red, this rotates the hue toward violet/magenta or yellow/green to adjust the coloring of the entire image.
	[Yellow]	Enhances the contrast. (Effect: weak) Records the sky with a clear blue.
	[Orange]	Enhances the contrast. (Effect: medium) Records the sky with a darker blue.
	[Red]	Enhances the contrast. (Effect: strong) Records the sky with a much darker blue.
	[Green]	Skin and lips of people appear in natural tones. Green leaves appear brighter and more enhanced.
	[Off]	—





 [Grain Effect]*4	[Low]/ [Standard]/ [High]	Sets the grain effect level.
	[Off]	
S [Sharpness]	Adjusts the outlines in the image.	
NR [Noise Reduction]	Adjusts the noise reduction effect. • Increasing the effect may cause a slight drop in picture resolution.	
ISO [Sensitivity]*5	Sets the ISO sensitivity. (→ 192)	
WB [White Balance]*5	Sets the white balance. (→ 194) • While [WB] is selected, press [] to display the white balance setting screen. Press [] again to return to the original screen.	

- *1 Cannot be adjusted when [Like709], [Standard(HLG)] or [Monochrome(HLG)] is selected.
- *2 Available when anything other than [Monochrome], [L.Monochrome], [L.Monochrome D] or [Monochrome(HLG)] is selected.
- *3 Available when [Monochrome], [L.Monochrome], [L.Monochrome D] or [Monochrome(HLG)] is selected.
- *4 Available when [Monochrome], [L.Monochrome] or [L.Monochrome D] is selected.
- *5 Available when [MY PHOTO STYLE 1] to [MY PHOTO STYLE 10] is selected. To use this, set [Sensitivity] and [White Balance] to [ON] in [Add Effects] in [My Photo Style Settings] in [Photo Style Settings] of the [Custom] ([Image Quality]) menu.



- You can set the knee mode with [Like709].
For details, refer to page 241.
- The effects of [Grain Effect] cannot be checked on the recording screen.
- [Grain Effect] is not available when using the following functions:
 - Video recording/[6K/4K PHOTO]/[Post-Focus]

❖ Registering Settings in My Photo Style

- ❶ Press ◀▶ to select the type of Photo Style.
- ❷ Adjust the image quality.
 - My Photo Style displays the types of Photo Style at the top of image quality adjustment.
Select the base Photo Style.
- ❸ Press [DISP.].
- ❹ (When [MY PHOTO STYLE 1] to [MY PHOTO STYLE 10] is selected)
Press ▲▼ to select [Save Current Setting] and then press  or .
- ❺ Press ▲▼ to select the registration destination number and then press  or .
 - A confirmation screen will be displayed.
On the confirmation screen, press [DISP.] to change the My Photo Style name.
Up to 22 characters may be entered. Double-byte characters are treated as 2 characters.
For information on how to enter characters, refer to page 369.

❖ Changing the Registered Contents of My Photo Style

- ❶ Select any value from [MY PHOTO STYLE 1] to [MY PHOTO STYLE 10].
- ❷ Press [DISP.] and then set the item.

[Load Preset Setting]

[Save Current Setting]

[Edit Title]

[Restore to Default]

[Filter Settings]

iA P A S M 

This mode records with additional image effects (filters).

You can adjust the effect for each filter.

In addition, you can simultaneously take pictures without effects.

1 Set the [Filter Effect].

-  → [] → [] → [Filter Settings] → [Filter Effect] → [SET]

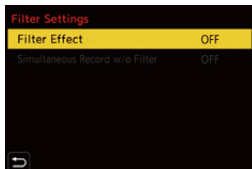

2 Select the filter.

- Press ▲▼ to select, and then press

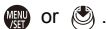

- You can also select the image effect (filter) by touching the sample picture.

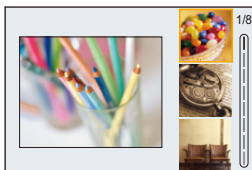



- Press [DISP.] to switch the screen in the order of normal display, guide display, and list display.

The guide display shows the description of each filter.

❖ Adjusting the Filter Effect

You can adjust the filter effect.

- 1 Select the filter.
- 2 On the recording screen, press [WB].
- 3 Rotate ,  or  to set.
 - To return to the recording screen, press [WB] again.
 - When the filter effect is adjusted, the filter icon on the recording screen is indicated with [*].



Filter	Items that can be adjusted
[Expressive]	Vividness
[Retro]	Coloring
[Old Days]	Contrast
[High Key]	Coloring
[Low Key]	Coloring
[Sepia]	Contrast
[Monochrome]	Coloring
[Dynamic Monochrome]	Contrast
[Rough Monochrome]	Grittiness
[Silky Monochrome]	Defocus level
[Impressive Art]	Vividness
[High Dynamic]	Vividness
[Cross Process]	Coloring
[Toy Effect]	Coloring
[Toy Pop]	Area with reduced peripheral brightness
[Bleach Bypass]	Contrast
[Miniature Effect]	Vividness
[Soft Focus]	Defocus level
[Fantasy]	Vividness
[Star Filter]	: Short rays/Long rays
	: Few rays/Many rays
	: Rotate to left/Rotate to right
[One Point Color]	Amount of color left
[Sunshine]	Coloring

❖ Setting a Filter with Touch Operation



- The default settings are for the touch tab to not be displayed. Set the [Touch Tab] in [Touch Settings] to [ON]. (→ 333)

1 Touch [].



2 Touch the item to set.

[]: Filter on/off



[EXPS]: Filter

[]: Filter effect adjustment



- White balance will be fixed to [AWB] and the flash will be fixed to [] (Forced Flash Off).
- The upper limit to ISO sensitivity is [ISO6400].
- When [High Dynamic] is set, the lower limit of the ISO sensitivity is fixed to [ISO400] and the higher limit to [ISO6400].
- Depending on the filter, the recording screen may seem as if frames are missed.
- [Rough Monochrome]/[Silky Monochrome]/[Soft Focus]/[Star Filter]/[Sunshine] are not available when using the following functions:
 - [] mode
 - Video recording
- When [Image Area of Video] is [APS-C] or [PIXEL/PIXEL], recording video with [Toy Effect]/[Toy Pop] is not possible.
- When using APS-C lenses, [Toy Effect]/[Toy Pop] are not available.
- [Filter Effect] is not available when using the following functions:
 - [High Resolution Mode]
 - [High Speed Video]



- Filter on/off operations can be registered to a Fn button:
 - [] ⇒ [] ⇒ [Fn Button Set] ⇒ [Setting in REC mode] ⇒ [Filter Effect] (→ 278)
- When displaying the [Filter Effect] setting screen using the Fn button, pressing [DISP.] displays the filter selection screen.

❖ Setting the Type of Defocus ([Miniature Effect])

1 Set [Filter Effect] to [Miniature Effect].



2 Press ▲ to display the setting screen.

- The setting screen can also be displayed by touching [] then [].

3 Press ▲▼ or ◀▶ to move the in-focus portion.

- You can also move the in-focus portion by touching the screen.
- You can also switch the defocus orientation by touching [].



4 Rotate  ,  or  to change the size of in-focus portion.

- The portion can also be enlarged/reduced by pinching out/pinching in the screen.
- To reset the in-focus portion setting to the default, press [DISP.].



5 Press  or  to set.



- No audio is recorded in videos.
- When video recording, the length of a recorded video will be approx. 1/10 of the actual recording time.
(If you record for 10 minutes, the resulting video recording will be approx. 1 minute long.)
The available recording time displayed for this effect will be approx. 10 times longer than for normal video recording.
- If you end video recording after a short time, the camera may go on recording for a certain period.

❖ Setting the Color to Be Left ([One Point Color])

- 1 Set [Filter Effect] to [One Point Color].
- 2 Press **▲** to display the setting screen.

- The setting screen can also be displayed by touching [] then [].

- 3 Press **▲▼◀▶** to move the frame and select the color you want to leave.

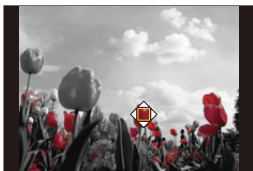

- Positions can be moved to the diagonal directions using the joystick.
- You can also select the color you want to leave by touching the screen.
- To return the frame back to the center, press [DISP.].



- 4 Press  or  to set.

❖ Setting the Light Source Position and Size ([Sunshine])



- 1 Set [Filter Effect] to [Sunshine].
- 2 Press **▲** to display the setting screen.

- The setting screen can also be displayed by touching [] then [].

- 3 Press **▲▼◀▶** to move the center position of the light source.

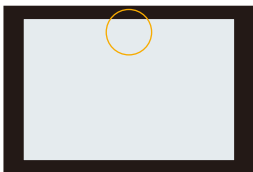
- Positions can be moved to the diagonal directions using the joystick.
- The position of the light source can also be moved by touching the screen.





- 4 Rotate  ,  or  to adjust the size of the light source.

- This can also be enlarged/reduced by pinching out/pinching in the screen.
- To reset the light source setting to the default, press [DISP.].

- 5 Press  or  .

[Simultaneous Record w/o Filter]

You can simultaneously take pictures with no added filter effects.

 ⇒ [] ⇒ [] ⇒ [Filter Settings] ⇒ Select [Simultaneous Record w/o Filter]

Settings: [ON]/[OFF]



- [Simultaneous Record w/o Filter] is not available when using the following functions:
 - Burst recording
 - [6K/4K PHOTO]/[Post-Focus]
 - [Time Lapse Shot]
 - [Stop Motion Animation]
 - [RAW+FINE]/[RAW+STD.]/[RAW] ([Picture Quality])
 - [Bracketing]

[High Resolution Mode]

iA P A S M



This merges pictures with a high resolution from multiple recorded images. This function is suitable for recording subjects that do not move.

Merged pictures will be saved as RAW files with a maximum image size of 187 M.



- Use a tripod to minimize camera shake.
- The image stabilization function is automatically turned off.

1 Set [High Resolution Mode].

- → [] → [] → [High Resolution Mode]



2 Start High Resolution mode.

- Select [Start] and then press or .

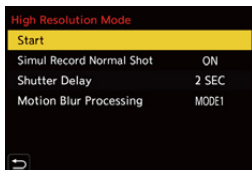

3 Decide on the composition and then fix the camera in place.

- If blurring is detected, the High Resolution mode icon (A) blinks.



4 Start recording.

- Press the shutter button fully.
- With the default settings, [Shutter Delay] is activated, so there will be a gap in time from when the shutter button is pressed until the shutter is released.
- The screen goes dark during recording.
- The recording state indication (red) (B) blinks.
- Do not move the camera while it is blinking.
- You can continue recording when the merging process ends.



5 End [High Resolution Mode].

- Press [Q].

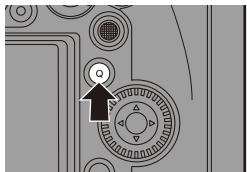

❖ Setting Items ([High Resolution Mode])

[Start]	Starts High Resolution mode.
[Simul Record Normal Shot]	Simultaneously takes pictures that are not merged when [ON] is set. The first picture will be saved with [Picture Size] set to [L].
[Shutter Delay]	Sets the delay time from when the shutter button is pressed until the shutter is released.
[Motion Blur Processing]	Sets the correction method to use when the subject moved. [MODE1]: This gives priority to High Resolution mode, therefore subject blur appears as an afterimage in the picture. [MODE2]: This reduces afterimage from subject blur, but cannot obtain the same High Resolution mode effect in the corrected range.

❖ Picture Quality/Image Size After Merging



- The recording [Picture Quality] will be [RAW].
- RAW images recorded in [High Resolution Mode] cannot be processed from [RAW Processing] in the [Playback] menu. Use the "SILKYPIX Developer Studio" software. (→ 430)
- The image size will vary depending on the [Aspect Ratio] setting.

[Aspect Ratio]	Picture size
[4:3]	14880×11168 (166 M)
[3:2]	16736×11168 (187 M)
[16:9]	16736×9424 (157.5 M)
[1:1]	11168×11168 (124.5 M)



- In [High Resolution Mode], the following functions are restricted:
 - [Shutter Type]: Fixed to [ELEC.]
 - Minimum aperture value: F16
 - Shutter speed: 1 second to 1/16000 of a second
 - ISO sensitivity: Up to [ISO3200]
 - Focus mode: Fixed to [AFS] or [MF]
- When you record in an extremely bright location or under fluorescent/LED lighting, the coloring or brightness of the image may change or horizontal stripes may appear on the screen.
Lowering the shutter speed may reduce the effect of horizontal stripes.
- The image produced by combining is displayed when Auto Review.
- The image periphery cannot be displayed enlarged when the camera is used for playback.
- Devices other than this camera may not be able to play back images recorded using [High Resolution Mode].
- When the following functions are being used, [High Resolution Mode] is not available:
 - [Time Lapse Shot]
 - [Stop Motion Animation]
 - [Filter Settings]
 - [Multiple Exposure]
- When using APS-C lenses, recording in [High Resolution Mode] is not possible.



- You can register functions to Fn buttons:
[] ⇒ [] ⇒ [Fn Button Set] ⇒ [Setting in REC mode] ⇒ [High Resolution Mode] (→ 278)

[HLG Photo]

iA P A S M 



Records an HLG format picture with a wide dynamic range. Bright lights that are easily overexposed, and dark areas that are easily underexposed can be recorded showing fine quality and rich colors just as seen with the human eyes.

Recorded pictures can be output over HDMI to devices (TV, etc.) that support HLG format pictures for viewing.

Additionally, devices that also support the HSP format can directly play back images.

- “HLG (Hybrid Log Gamma)” is an international standard (ITU-R BT.2100) HDR format.
- “HSP” is an HDR picture format using HLG format video technology. These images are saved with a “.HSP” file extension.

 →  →  → Select [HLG Photo]

Setting items	[Aspect Ratio]			
	[4:3]	[3:2]	[16:9]	[1:1]
[8K-Res.]	5760×4320	6464×4320	7680×4320	4320×4320
[4K-Res.]	2880×2160	3232×2160	3840×2160	2144×2144
[OFF]	—			

- The picture size of HLG-format pictures differs depending on [Aspect Ratio] settings. [Aspect Ratio] settings of [65:24] and [2:1] cannot be set.
- [Photo Style] can be selected from [Standard(HLG)] or [Monochrome(HLG)]. (→ 199)
- JPEG images and RAW images are recorded simultaneously in accordance with [Picture Quality] (→ 85) and [Picture Size] (→ 83).
RAW images recorded using [HLG Photo] can be written as HLG images using [RAW Processing] (→ 271).





- The monitor and viewfinder on this camera do not support display of HLG format images.
With [HLG View Assist] in the [Custom] ([Monitor / Display]) menu, you can display images that have been converted for confirmation on the monitor/viewfinder of the camera or a device connected via HDMI. (→ 347)



- HLG images appear darker on devices that do not support the HLG format.
- When using APS-C lenses, [8K-Res.] cannot be used.
- When the following functions are being used, [HLG Photo] is not available:
 - [6K/4K PHOTO]/[Post-Focus]
 - [High Resolution Mode]
 - [Filter Settings]
 - [Multiple Exposure]



- You can register functions to Fn buttons:
[] ⇒ [] ⇒ [Fn Button Set] ⇒ [Setting in REC mode] ⇒ [HLG Photo]
(→ 278)

10. Flash

Using an External Flash (Optional)

iA P A S M 



If you attach the Flash (DMW-FL580L/DMW-FL360L/DMW-FL200L: optional) to the hot shoe, you can record using the flash.

You can also use a commercially available external flash by connecting a commercially available synchro cable to the flash synchro socket.

Furthermore, by attaching a compatible external flash to the camera, you can wirelessly control external flashes placed in positions away from the camera.



- Before use, remove the lens hood to prevent vignetting.
- Flash recording is not possible when the following functions are being used:
 - Video recording/[6K/4K PHOTO]/[Post-Focus]
 - [ELEC.]/[Silent Mode]/[High Resolution Mode]
 - [Filter Settings]

Removing the Hot Shoe Cover

Before attaching the Flash (optional), remove the hot shoe cover.

Refer to the operating instructions for the Flash for details about how to attach it.

Remove the hot shoe cover by pulling it in the direction indicated by arrow ② while pressing it in the direction indicated by arrow ①.

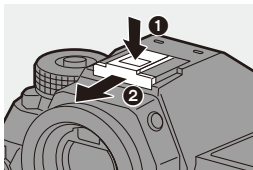

❖ Connecting a Synchro Cable to the Flash Synchro Socket

You can use a commercially available external flash by connecting a commercially available synchro cable to the flash synchro socket.

The socket has a lock screw to prevent the cable from falling off.

Before connecting the synchro cable to the flash synchro socket, remove the flash synchro socket cap.



- Use an external flash with a synchronization voltage of 400 V or less.
- Do not use the synchro cables with the length of 3 m (9.8 feet) or more.

1 Rotate the flash synchro socket cap in the direction of the arrow to remove.

- Be careful not to lose the flash synchro socket cap.

2 Connect the synchro cable to the flash synchro socket.

- For the connection, refer to the operating instructions for the synchro cable.

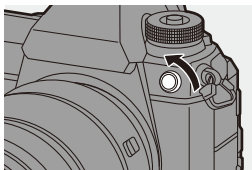

- The flash synchro socket has no polarity. You can use a synchro cable regardless of its polarity.

❖ Notes on Flash Recording



- Do not bring any object near the flash. Heat or light may cause the object to deform or discolor.
- If you record repeatedly, time may be needed to charge the flash. While the flash is charging, images will be recorded without the flash firing.
- When an external flash is attached, do not carry the camera by holding only the external flash. It may become detached.
- When using a commercially available external flash, do not use one with reversed polarity or function for communicating with a camera. It may cause the camera to malfunction, or it may not operate correctly.
- Refer to the operating instructions for the external flash for details.

Setting Flash Functions

iA P A S M M





You can set the flash function to control flash firing from the camera.

[Firing Mode]/[Manual Flash Adjust.]

You can select whether to set the flash output automatically or manually. When setting the flash output manually, you can set it on the camera.

-  Firing mode cannot be set when using a Flash (DMW-FL580L/DMW-FL360L/DMW-FL200L: optional). It can be set only when using an external flash that does not use a battery (supplied with some models of Panasonic digital cameras).

1 Set the [Firing Mode].





-  → [] → [] → [Firing Mode]



[TTL]	Sets flash output to be set automatically by the camera.
[MANUAL]	Sets the flash output manually. <ul style="list-style-type: none"> With [TTL], you can record the images you want even when recording dark scenes where the flash output tends to become greater. The flash output ([1/1], etc.) is displayed on the flash icon of the recording screen.

2 (When set to [MANUAL])
Select [Manual Flash Adjust.]
and then press  or .



3 Press   to set the flash output and then press  or .

- It can be set within the range of [1/1] (full flash output) to [1/64] in 1/3 steps.







[Flash Mode]





Set the flash mode.

 →  →  → Select [Flash Mode]





	(Forced Flash On)	The flash fires every time regardless of the recording conditions.
[]	(Forced On/Red-Eye)	This is suitable for recording when there is backlighting or under lighting such as fluorescent light.
[]	(Slow Sync.)	When recording images against a dark background landscape, this feature will slow the shutter speed when the flash fires.
[]	(Slow Sync./Red-Eye)	<ul style="list-style-type: none"> • Slower shutter speeds may result in blurry images. To avoid this, we recommend using a tripod.
[]	(Forced Flash Off)	The flash does not fire.



- The flash fires twice.
The interval between the first and second firings is longer when [] or [] is set. The subject should not move until the second firing has finished.
- [] and [] cannot be used when the following are set:
 - [Firing Mode]: [MANUAL]
 - [Flash Synchro]: [2ND]
 - [Wireless]: [ON]
- Some flash modes may not be available depending on the settings on the external flash.
- The effectiveness of red-eye reduction varies from person to person.
The effect, which is influenced by factors such as distance to the subject and whether the subject is looking at the camera when the preliminary flash is fired, may not be very noticeable in some cases.
- When the following functions are being used, the flash mode is fixed to []:
 - Video recording/[6K/4K PHOTO]/[Post-Focus]
 - [ELEC.]/[Silent Mode]/[High Resolution Mode]
 - [Filter Settings]



- You can register functions to Fn buttons:
[] ⇒ [] ⇒ [Fn Button Set] ⇒ [Setting in REC mode] ⇒ [Flash Mode]
(→ 278)

❖ Available flash settings by recording mode

The available flash settings depend on the recording mode.

(✓: Available, —: Not available)

Recording mode					
[P]/[A]	✓	✓	✓	✓	✓
[S]/[M]	✓	✓	—	—	✓



• In [iA] mode, this will be [A].

❖ Shutter speeds for flash modes

[Flash Mode]	Shutter speed (sec.)
	1/60 ^{*1} to 1/320 ^{*2}
	1 to 1/320 ^{*2}

*1 In [S] mode, this will be 60 seconds and in [M] mode it will be B (Bulb).

*2 The maximum setting changes to 1/250 of a second in [P]/[A] modes.

• The guide number decreases when the shutter speed is set to 1/320 of a second.



[Flash Synchro]

When a moving subject is recorded at night using a slow shutter and flash, a trail of light may appear in front of the subject.

If you set [Flash Synchro] to [2ND], you can take a dynamic picture with a trail of light appearing behind the subject by firing the flash immediately before the shutter closes.

MENU SET → [📷] → [⚡] → **Select [Flash Synchro]**



[1ST]	This is the normal method for recording with the Flash.	
[2ND]	The light source appears behind the subject and the picture becomes dynamic.	



- When [2ND] is set, [2nd] is displayed on the flash icon of the recording screen.
- When [Wireless] is set to [ON], this is fixed to [1ST].
- The effect may not be adequately achieved at faster shutter speeds.

Adjusting the Flash Output

You can adjust the flash output when taking pictures with the flash in TTL output mode.

1 Select [Flash Adjust.].

- **MENU/SET** → [📷] → [⚡] → [Flash Adjust.]



2 Press ◀▶ to adjust the flash output and then press **MENU/SET** or .

- It can be adjusted within the range of [-3 EV] to [+3 EV] in 1/3 EV steps.

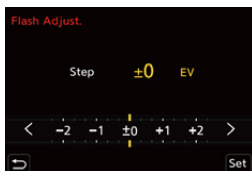

- [⚡] is displayed on the recording screen.
- For information about adjusting the flash output when recording using a wireless flash, refer to page 228.
- [Flash Adjust.] cannot be used when the following are set:
 - [Firing Mode]: [MANUAL]
 - [Wireless]: [ON]
- You can register functions to Fn buttons:
 - [⚙️] → [🌞] → [Fn Button Set] → [Setting in REC mode] → [Flash Adjust.] (→ 278)



[Auto Exposure Comp.]

Automatically adjust the flash output in conjunction with the exposure compensation value. (→ 189)

 →  →  → **Select [Auto Exposure Comp.]**

Settings: [ON]/[OFF]

[Red-Eye Removal]

When [Flash Mode] is set to [] or [], the camera automatically detects red-eye and corrects image data.

 →  →  → **Select [Red-Eye Removal]**

Settings: [ON]/[OFF]



- When [ON] is set, [] is displayed on the flash icon.
- Red-eye cannot be corrected depending on its appearance.
- When [HLG Photo] is being used, [Red-Eye Removal] is not available.

Recording Using a Wireless Flash

iA P A S M 



You can use a Flash (DMW-FL580L/DMW-FL360L/DMW-FL200L: optional) to record using a wireless flash.

You can separately control the firing of three flash groups and the flash attached to the hot shoe of the camera.

❖ Placing a Wireless Flash

Place the wireless flash with its wireless sensor facing the camera.

Placement example

When C is placed to erase the shadow in the background of the subject that the flash groups A and B will create

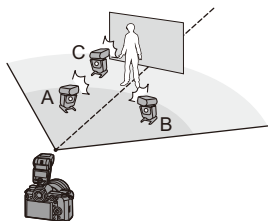

Placement range

When DMW-FL360L is attached

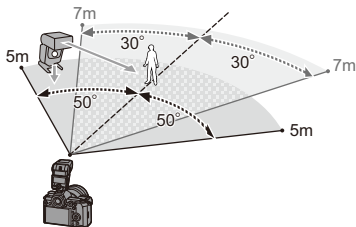

- The placement range serves as a guide for when recording with the camera held horizontally. The range differs depending on the surrounding environment.
- We recommend using a maximum of three wireless flashes in each group.
- If the subject is too close, communication light may affect the exposure. You can reduce the effect by setting [Communication Light] to [LOW] or lowering the output with a diffuser or similar device. (→ 229)

- 1** Attach an external flash to the camera. (→ 216)

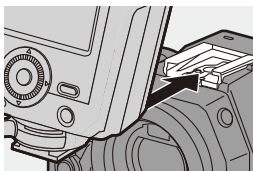

- 2** Set the wireless flashes to [RC] mode and then place them.

- Set the channel and group for the wireless flashes.

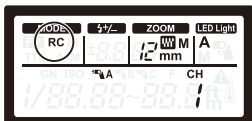

- 3** Enable the wireless flash function of the camera.

- **MENU** SET → [CAMERA] → [FLASH] → [Wireless] → [ON]



- 4** Set [Wireless Channel].

- Select the same channel as on the wireless flash side.



- 5** Set [Wireless Setup].

- Set the firing mode and flash output.



❖ Setting Items ([Wireless Setup])

- To fire a test flash, press [DISP.].

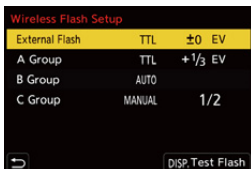



[External Flash]*1	[Firing Mode]	<p>[TTL]: The camera automatically sets the flash output.</p> <p>[AUTO]⁺²: Sets the flash output on the external flash side.</p> <p>[MANUAL]: Sets the flash output of the external flash manually.</p> <p>[OFF]: The external flash outputs only communication light.</p>
	[Flash Adjust.]	Adjusts the flash output of the external flash manually when [Firing Mode] is set to [TTL].
	[Manual Flash Adjust.]	<p>Sets the flash output of the external flash when [Firing Mode] is set to [MANUAL].</p> <ul style="list-style-type: none"> It can be set within the range of [1/1] (full flash output) to [1/128] in 1/3 steps.
[A Group]/ [B Group]/ [C Group]	[Firing Mode]	<p>[TTL]: The camera automatically sets the flash output.</p> <p>[AUTO]⁺¹: Sets the flash output on the wireless flash side.</p> <p>[MANUAL]: Sets the flash output of the wireless flash manually.</p> <p>[OFF]: The wireless flashes of the specified group will not fire.</p>
	[Flash Adjust.]	Adjusts the flash output of the wireless flash manually when [Firing Mode] is set to [TTL].
	[Manual Flash Adjust.]	<p>Sets the flash output of the wireless flash when [Firing Mode] is set to [MANUAL].</p> <ul style="list-style-type: none"> It can be set within the range of [1/1] (full flash output) to [1/128] in 1/3 steps.

*1 This cannot be selected when [Wireless FP] is set.

*2 This cannot be set when using the Flash (DMW-FL200L: optional).



- You can register functions to Fn buttons:

[] → [] → [Fn Button Set] → [Setting in REC mode] → [Wireless Flash Setup] (→ [278](#))

❖ [Wireless FP]

The external flash performs FP firing (repeated high-speed firing of the flash) during wireless recording, enabling recording using the Flash even at fast shutter speeds.



→ [] → [] → Select [Wireless FP]

Settings: [ON]/[OFF]

❖ [Communication Light]

Set the strength of communication light.



→ [] → [] → Select [Communication Light]

Settings: [HIGH]/[STANDARD]/[LOW]

11. Recording Videos

Recording Videos

iA P A S M 



This camera can record 4K videos in MP4 format and full high-definition videos that comply with the AVCHD standard.

Furthermore, the Creative Video mode, especially created for video recording, enables you to record using settings for exposure, white balance, etc., especially suited to video.

Audio is recorded in stereo.

1 Start recording.

- Press the video rec. button.
- The live view angle of view changes to the angle of view for video recording, and the available recording time and elapsed recording time are displayed.

- (A) Elapsed recording time
- (B) Card access indication
- (C) Available recording time
- (D) Recording state indication

- Release the video rec. button right after you press it.
- The recording state indication and card access indication light red while videos are being recorded.
- h: hour, m: minute, s: second

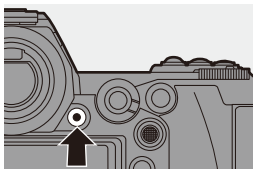

2 Stop recording.

- Press the video rec. button again.



- The available recording time can be displayed during recording standby:
[] → [] → [Photos/Videos Remaining] (→ 345)
- You can switch the live view angle of view to the angle of view for video recording:
[] → [] → [Photo/Video Preview] (→ 344)

❖ Exposure Control While Video Recording

Videos will be recorded using the aperture, shutter speed, and ISO sensitivity settings below.

Recording mode	Aperture value/shutter speed/ISO sensitivity
iA	The camera automatically makes the settings to suit the scene.
P/A/S/M	The settings vary depending on the [Auto Exposure in P/A/S/M] in the [Video] ([Image Quality]) menu. The default setting is [ON]. [ON]: Records with values set automatically by the camera. [OFF]: Records with manually set values.
M	Set manually.



- If an operation such as a zoom or button operation is performed during video recording, that operation sound may be recorded.
- The functions available during the video recording differ depending on the lens you are using. Also, the lens operation sound may be recorded.
- If the operation sound of pressing the video rec. button to end recording bothers you, try the following:
 - Record the video about 3 seconds longer, and then divide the last part of the video using [Video Divide] in the [Playback] ([Edit Image]) menu.
 - Use the Shutter Remote Control (DMW-RS2: optional) for recording.
- Depending on the type of card, the card access indication may appear for a while after video recording. This is not a malfunction.
- Even when playback is performed on a supported device, situations may occur where image or sound quality is poor, recording information is not displayed correctly, or playback is not possible, for example. If you experience any of these, play them back on the camera.
- If the camera temperature rises under the any of following conditions, [] may be displayed and recording may stop. Wait until the camera cools down.
 - During continuous video recording
 - When the ambient temperature is high
- Video recording is not possible while you are using the following functions:
 - [Time Lapse Shot]
 - [Stop Motion Animation]
 - [Rough Monochrome]/[Silky Monochrome]/[Soft Focus]/[Star Filter]/[Sunshine] ([Filter Settings])
 - [HLG Photo]
 - [Post-Focus]

Video Settings

[Rec. File Format]



iA P A S M 



Sets the video recording file format.

 → [] → [] → Select [Rec. File Format]

[AVCHD]	This data format is suitable for playback on high-definition TVs. • AVCHD videos cannot be recorded to XQD cards.
[MP4]	This data format is suitable for playback on PCs.

-  You can register functions to Fn buttons:
 [] → [] → [Fn Button Set] → [Setting in REC mode] → [Motion Pic. Rec Format] (→ [278](#))

[Rec Quality]



Sets the video recording image quality.

This camera can record videos in 4K (3840×2160) or full high-definition (1920×1080) resolution. The image quality settings that can be selected vary depending on the [Rec. File Format] setting.

→ → → Select [Rec Quality]

[Rec. File Format]: [AVCHD]

[Rec Quality]	Resolution	Frame rate	Bit rate	YUV/bit	Audio compression method
[FHD/28M/60p]*1	1920×1080	60p	28 Mbps	4:2:0/8 bit	Dolby Audio
[FHD/17M/60i]	1920×1080	60i	17 Mbps	4:2:0/8 bit	Dolby Audio
[FHD/24M/30p]	1920×1080	60i*2	24 Mbps	4:2:0/8 bit	Dolby Audio
[FHD/24M/24p]	1920×1080	24p	24 Mbps	4:2:0/8 bit	Dolby Audio

*1 AVCHD Progressive

*2 Sensor output: 30 frames/second

[Rec. File Format]: [MP4]

[Rec Quality]	Resolution	Frame rate	Bit rate	YUV/bit	Audio compression method
[4K/LPCM/150M/60p]* ^{3, 4}	3840×2160	60p	150 Mbps	4:2:0/8 bit	LPCM
[4K/100M/30p]* ⁴	3840×2160	30p	100 Mbps	4:2:0/8 bit	AAC
[4K/100M/24p]* ⁴	3840×2160	24p	100 Mbps	4:2:0/8 bit	AAC
[FHD/28M/60p]	1920×1080	60p	28 Mbps	4:2:0/8 bit	AAC
[FHD/20M/30p]	1920×1080	30p	20 Mbps	4:2:0/8 bit	AAC

*3 These videos are intended for editing on a PC.

Playback and editing on other than this camera require a high-performance PC environment.



*4 Recording stops when the continuous recording time exceeds 15 minutes.

- In this document, 4K resolution (3840×2160) video is indicated as **4K video**, and full high definition resolution (1920×1080) video is indicated as **FHD video**.



- All videos will be recorded using Long GOP to compress the images.
- The higher the bit rate value is, the higher the image quality becomes. Since the camera employs the VBR recording format, the bit rate is changed automatically depending on the subject to record. As a result, the available recording time is shortened when a fast-moving subject is recorded.
- 4K videos cannot be recorded when recording with [Miniature Effect] in [Filter Settings].
- When recording 4K videos to an SD card, use a card rated at UHS Speed Class 3 or higher.



- You can register functions to Fn buttons:
[] ⇒ [] ⇒ [Fn Button Set] ⇒ [Setting in REC mode] ⇒ [Motion Pic. Rec Quality] (→ [278](#))

❖ Size Interval for Dividing Files

[Rec. File Format]	[Rec Quality]	Size interval for dividing files
[AVCHD]	All	A new file will be created to continue recording if the file size exceeds 4 GB. The files recorded can be played back continuously.
[MP4]	FHD	A new file will be created to continue recording if the continuous recording time exceeds 30 minutes or the file size exceeds 4 GB.
	4K	<p>When using an SDHC memory card or an XQD card of 32 GB or less:</p> <p>A new file will be created to continue recording if the file size exceeds 4 GB.</p> <p>When using an SDXC memory card or an XQD card over 32 GB:</p> <p>Files are not divided for recording.</p>

[Image Area of Video]

iA P A S M 



Set the image area during video recording.

The angle of view differs depending on the image area.

Narrowing the image area allows you to achieve a telescopic effect without image deterioration.

 ⇒ [] ⇒ [] ⇒ Select [Image Area of Video]

Item	Settings details	Angle of view	Telescopic effect
[FULL]	Records with the full sensor area.	Wide ⇕ Narrow	None ⇕ High
[APS-C]	Records using a range corresponding to the APS-C lens image circle.		
[PIXEL/PIXEL]	Records with one pixel on the sensor, which is equal to one pixel of the video. Records a range corresponding to the resolution range in [Rec Quality]. (→ 234)		



- To check the image area in recording modes other than [] mode, set [Photo/Video Preview] to []. (→ 344)
- When using APS-C lenses, [FULL] automatically switches to [APS-C].
- When using the following functions, the image area of [FULL] and the angle of view will become narrower:
 - 4K Video
 - [60/30p 4K]/[48/23.98p 4K] ([High Speed Video])

Image area (Ex.: FHD video)



- When the following functions are being used, [Image Area of Video] is fixed to [APS-C]:
 - [180/30p FHD] ([High Speed Video])
- When the following functions are being used, [PIXEL/PIXEL] is not available:
 - [High Speed Video]

[Continuous AF]

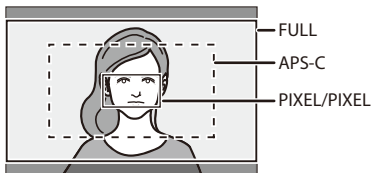

You can select how to set the focus in AF when recording videos.



⇒ [MENU/SET] ⇒ [Video] ⇒ [FOCUS] ⇒ Select [Continuous AF]

[Continuous AF]	Description of setting
[ON]	The camera automatically keeps focusing on subjects during recording.
[OFF]	The camera maintains the focus position at the start of recording.



- If you press the shutter button halfway while recording a video, the camera will re-adjust the focus.
- Depending on the recording conditions or lens used, the AF operation sound may be recorded during video recording.
If the operation sound bothers you, we recommend recording with [Continuous AF] set to [OFF].
- If the zoom is operated while recording videos, the subject may take a while to come into focus.

[AF Custom Setting(Video)]



You can fine-adjust the focusing method for video recording using [Continuous AF].



⇒ [Video] ⇒ [Focus] ⇒ Select [AF Custom Setting(Video)]

[ON]	Enables the following settings.	
[OFF]	Disables the following settings.	
[SET]	[AF Speed]	[+] side: Focus moves at a faster speed. [-] side: Focus moves at a slower speed.
	[AF Sensitivity]	[+] side: When the distance to the subject changes significantly, the camera immediately readjusts the focus. [-] side: When the distance to the subject changes significantly, the camera waits for a little before readjusting the focus.



- You can register functions to Fn buttons:
[Settings] ⇒ [Focus] ⇒ [Fn Button Set] ⇒ [Setting in REC mode] ⇒ [AF Custom Setting(Video)] (→ 278)

[Luminance Level]

iA P A S M 



You can set the luminance range to suit the purpose of video recording.

- This can be set when [Rec. File Format] is set to [MP4].

 ⇒ [] ⇒ [] ⇒ Select [Luminance Level]

Settings: [0-255]/[16-255]



- This is fixed to [16-255] when [Rec. File Format] is set to [AVCHD].
- This is fixed to [64-940] when recording [HLG Photo] and to [0-255] when taking other types of pictures.

Recording While Controlling Overexposure (Knee)

iA P A S M 



When [Photo Style] is set to [Like709], you can adjust the knee so that recording can be performed with minimal overexposure.

1 Set [Photo Style] to [Like709].

-  ⇒ [] ⇒ [] ⇒ [Photo Style] ⇒ [Like709]

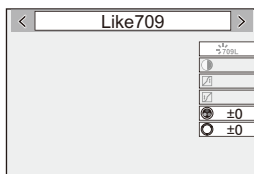

2 Press [Q].

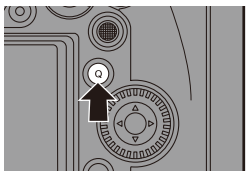

3 Select a knee setting.

- Press ◀▶ to select a setting item.

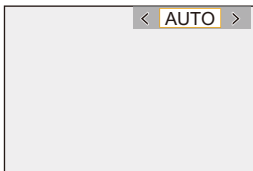

[AUTO]	Adjusts the compression levels of high-luminance areas automatically.
[MANUAL]	<p>Allows you to adjust the master knee point and master knee slope manually.</p> <p>Press ▲▼ to select an item and then press ◀▶ to adjust.</p> <p>[POINT]: Master knee point [SLOPE]: Master knee slope</p> <ul style="list-style-type: none"> • Rotate 🌞 to adjust the knee master point, and 🌞 to adjust the knee master slope. • Values within the following ranges can be set: <ul style="list-style-type: none"> – Master knee point: 80 to 107 – Master knee slope: 0 to 99
[Off]	—

4 Confirm your selection.

- Press  or .

Displaying/Setting the Sound Recording Level



❖ [Sound Rec Level Disp.]

The sound recording level is displayed on the recording screen.

→ [] → [] → Select [Sound Rec Level Disp.]

Settings: [ON]/[OFF]



- When [Sound Rec Level Limiter] is set to [OFF], [Sound Rec Level Disp.] is fixed to [ON].



- You can register functions to Fn buttons:
[] → [] → [Fn Button Set] → [Setting in REC mode] → [Sound Rec Level Disp.] (→ 278)

❖ [Sound Rec Level Adj.]

Manually adjust the sound recording level.

- 1 Select [Sound Rec Level Adj.].
 - → [] → [] → [Sound Rec Level Adj.]
- 2 Press to adjust the sound recording level and then press or .
 - You can adjust the sound recording level within the range from -12 dB to +6 dB in steps of 1 dB.
 - Displayed dB values are approximate.



- You can register functions to Fn buttons:
[] → [] → [Fn Button Set] → [Setting in REC mode] → [Sound Rec Level Adj.] (→ 278)

❖ [Sound Rec Level Limiter]

The sound recording level is adjusted automatically to minimize sound distortion (crackling noise).

→ [] → [] → Select [Sound Rec Level Limiter]

Settings: [ON]/[OFF]

Creative Video Mode



The [M] mode (Creative Video mode) is a recording mode used exclusively for video recording. In this mode, you can perform the same exposure operations as in [P]/[A]/[S]/[M] modes.

Change the exposure and audio settings with touch operation to prevent operation sounds from being recorded.

Settings such as exposure and white balance can be changed independent of picture taking settings.

The following videos can only be recorded in [M] mode:

- [High Speed Video] (→ 247)

1 Set the mode dial to [M].

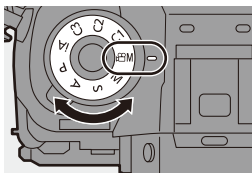

2 Set the exposure mode.

- [MENU/SET] → [Video Icon] → [Exposure Mode] → [P]/[A]/[S]/[M]

- You can perform the same exposure operations as the [P]/[A]/[S]/[M] modes.



3 Close the menu.





- Press the shutter button halfway.

4 Start recording.

- Press the shutter button or video rec. button.

5 Stop recording.

- Press the shutter button or video rec. button again.

- You can register functions to Fn buttons:
[] ➔ [] ➔ [Fn Button Set] ➔ [Setting in REC mode] ➔ [Exposure Mode] (➔ 278)
- You can set the upper and lower limits for ISO auto when recording in Creative Video mode.
[] ➔ [] ➔ [ISO Sensitivity (video)] (➔ 319)

❖ Operations During Video Recording

Change the exposure and audio settings with touch operation to prevent operation sounds from being recorded.

- 🔧 • With the default settings, the Touch Tab is not displayed.
Set [Touch Tab] to [ON] in [Touch Settings]. (➔ 333)



① Touch [].



② Touch an icon.

F	Aperture value
SS	Shutter speed
	Exposure compensation

ISO	ISO sensitivity
	Sound recording level adjustment

③ Drag the slide bar to set the item.

[]/[]: Changes the setting slowly.

[]/[]: Changes the setting quickly.

- If you touch icon (A), the screen of Step ② is redisplayed.

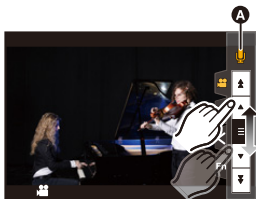

- 🔧 • The shutter speed can be set within a range of 1/25 of a second to 1/16000 of a second.

[CreativeVideo Combined Set.]



In default settings, settings such as exposure and white balance changed in [P/M] mode are also reflected in picture recording in [P]/[A]/[S]/[M] modes.

From the [CreativeVideo Combined Set.] menu, you can separate settings for video recording and for picture recording.

→ [] → [] → Select [CreativeVideo Combined Set.]

[F/SS/ISO/Exposure Comp.]	<p>:</p> <p>Links recording settings in [P/M] mode and [P]/[A]/[S]/[M] mode.</p> <ul style="list-style-type: none"> • Select to use the same settings in [P/M] mode and [P]/[A]/[S]/[M] mode.
[White Balance]	
[Photo Style]	
[Metering Mode]	<p>:</p> <p>Configures recording settings in [P/M] mode and [P]/[A]/[S]/[M] mode individually.</p> <ul style="list-style-type: none"> • Select to separate [P/M] mode and [P]/[A]/[S]/[M] mode settings.
[AF Mode]	

[High Speed Video]



Records slow videos of MP4 format by performing ultra-high-speed recording.

- Use a card rated at UHS Speed Class 3 or higher when using an SD card for this function.

→ → → Select [High Speed Video]

Item	Frame rate (for recording)	[Rec Quality] (for storage)	Slow motion effect
[180/30p FHD]	180 frames/second	FHD/20M/30p	Approx. 1/6×
[120/30p FHD]	120 frames/second	FHD/20M/30p	Approx. 1/4×
[60/30p 4K]	60 frames/second	4K/100M/30p	Approx. 1/2×
[48/23.98p 4K]	48 frames/second	4K/100M/24p	Approx. 1/2×
[OFF]		—	

- The setting of the focus mode switches to [MF].
- Sound is not recorded.
- You can perform continuous High Speed Video recording for up to 10 minutes.
- Under fluorescent lighting, flicker or horizontal stripes may be seen.

Recording Videos Using a Connected External Device

iA P A S M



External Monitor/Recorder ([HDMI Rec Output])

You can record while outputting the camera images to an external monitor or external recorder connected with an HDMI cable.

HDMI output control differs between during recording and during playback.

- Refer to page 357 for settings during playback.

Getting started:

- Turn off the camera and the external monitor/external recorder.

Connect the camera and an external monitor or external recorder with a commercially available HDMI cable.

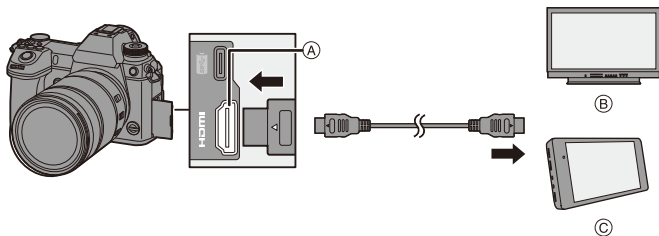

(A) [HDMI] socket (Type A)

(C) External recorder

(B) External monitor

- Check the direction of the terminals and plug in/out straight holding onto the plug. (Inserting these at an angle may cause deformation or malfunction)
- Do not connect the cable to the wrong terminals. This may cause a malfunction.



- Use a “High Speed HDMI cable” with the HDMI logo.
Cables that do not comply with the HDMI standards will not work.
“High Speed HDMI cable” (Type A–Type A plug, up to 1.5 m (4.9 feet) long)

❖ Attaching the Cable Holder

Use of the supplied cable holder prevents detachment of the cable and damage to the terminals.

- Put the camera on a stable surface to perform this task.

- 1 While pushing (A), slide the clamp portion (B) of the cable holder to remove it.

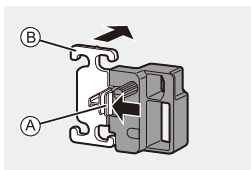

- 2 Open the door of the terminal section and slide the door into the part marked (C).

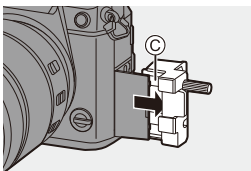

- 3 Loosely mount the cable holder to the mount on the camera (D), and then rotate the screws in the direction of the arrows to secure the cable holder (E).

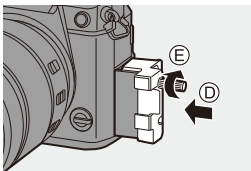

- 4 Fit the USB connection cable (C–C or A–C) (F) and HDMI cable (G) to the clamp.

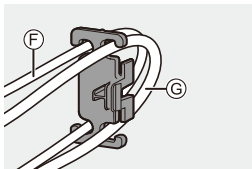

- 5 Slide the clamp portion (H) to attach it to the cable holder.

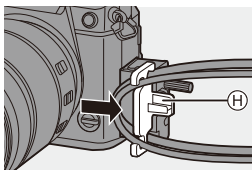

- 6 Connect the USB connection cable (C–C or A–C) to the USB port (I).

- 7 Connect the HDMI cable to the [HDMI] socket (J).

- K Leave some slack so that this section has a length of at least 10 cm (0.33 feet).

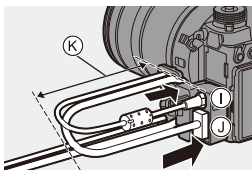

Removing the cable holder



To remove the cable holder, follow the steps for attaching it in the reverse order.



- Do not use any other USB connection cables except the supplied USB connection cables (C–C and A–C).
- We recommend using an HDMI cable with a thickness diameter of 6.5 mm (0.26 inch) or less.
- It may not be possible to attach HDMI cables of certain shapes.



❖ Images Output via the [HDMI] Socket (Sorted by Recording Mode)

	Recording Mode	
	 M	iA/P/A/S/M
Aspect ratio	Output is in accordance with the [Rec Quality] setting in the [Video] ([Image Format]) menu.	Output is in accordance with the [Aspect Ratio] setting in the [Photo] ([Image Quality]) menu. <ul style="list-style-type: none"> • With other than [16:9], pictures are output with bands added to their top and bottom or the left and right.
Resolution, frame rate		The output setting is determined by the connected device.
Output bit value	Output at 8-bit.	

- When [Photo/Video Preview] is set to  in a mode other than , the aspect ratio, resolution, and frame rate for output are in accordance with the [Rec Quality] setting in the [Video] ([Image Format]) menu.
- When recording videos, the output method changes to one equivalent to the output method of the  mode.
- It may take some time for the output method to change.

❖ Setting the Information Display During HDMI Output

Select whether or not to output the information display of the camera to an external device connected via HDMI.

 → [] → [] → [HDMI Rec Output] → Select [Info Display]
Settings: [ON]/[OFF]



- When you use the HDMI output during recording, the image may be displayed with a time lag.
- Beep sounds, AF beep, and electronic shutter sounds are muted during HDMI output.
- When you check the image and audio from the TV connected to the camera, the microphone of the camera may pick up the sound from the speakers of the TV, producing an abnormal sound (audio feedback).
If this occurs, move the camera away from the TV or lower the volume on the TV.
- Certain setting screens are not output via HDMI.
- There is no output via HDMI while you are using the following functions:
 - [6K/4K PHOTO]/[Post-Focus]

External Microphones (Optional)

With a Stereo Shotgun Microphone (DMW-MS2: optional) or Stereo Microphone (VW-VMS10: optional), you can record higher-quality audio compared to the built-in microphone.

1 Set the [Mic Socket] that suits the device to be connected.

-  ⇒ [] ⇒ [] ⇒ [Mic Socket]

MIC  [Mic Input (Plug-in Power)]	When connecting an external microphone that requires a power supply from the camera [MIC] terminal.
MIC [Mic Input]	When connecting an external microphone that does not require a power supply from the camera [MIC] terminal.
LINE [Line Input]	When connecting an external audio device for line output.

- The setting will be fixed to [Mic Input (Plug-in Power)] when a Stereo Shotgun Microphone (DMW-MS2: optional) is connected.
- When using [Mic Input (Plug-in Power)], if you connect an external microphone that does not require power supply, the connected external microphone may malfunction.

Check the device before connecting.

2 Turn off the camera.

3 Connect the camera and external microphone.

- If mounting the external microphone on the camera hot shoe (A), remove the hot shoe cover. (→ 216)

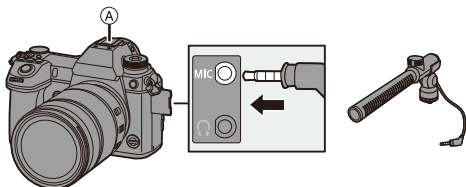

- Do not use the stereo microphone cables with the length of 3 m (9.8 feet) or more.

❖ Setting the Sound Pickup Range (DMW-MS2: Optional)

When using the Stereo Shotgun Microphone (DMW-MS2: optional), you can set the microphone sound pickup range.



1 Select [Special Mic.].

- → [] → [] → [Special Mic.]

[STEREO]	Picks up sound over a wide area.
[LENS AUTO]	Picks up sound from a range automatically set by the lens angle of view.
[SHOTGUN]	Helps prevent picking up background noise, and records sound from a specific direction.
[S. SHOTGUN]	Narrows the sound pickup range more than with [SHOTGUN].
[MANUAL]	Sets the range manually for sound pickup.



2 (When [MANUAL] is selected)

Press ◀▶ to adjust the sound pickup range and then press or .



- ➔ • You can register a function with the Fn button:
 [] ➔ [] ➔ [Fn Button Set] ➔ [Setting in REC mode] ➔ [Mic. Directivity Adjust] (➔ 278)

❖ Reduction of Wind Noise

This reduces wind noise when an external microphone is connected.

 ➔ [] ➔ [] ➔ Select [Wind Cut]

Settings: [HIGH]/[STANDARD]/[LOW]/[OFF]

-  • While the external microphone is connected, [] is displayed on the screen.
- When an external microphone is connected, [Sound Rec Level Disp.] automatically turns [ON], and the recording level is displayed on the screen.
- When the external microphone is attached, do not carry the camera by holding the external microphone. It may become detached.
- If noises are recorded when using the AC adaptor, use the battery.
- When [Special Mic.] is set to [LENS AUTO], [S. SHOTGUN] or [MANUAL], [Sound Output] is fixed to [REC SOUND].
- When a Stereo Microphone (VW-VMS10: optional) is used, [Special Mic.] is fixed to [STEREO].
- Setting [Wind Cut] may alter the usual sound quality.
- For details, refer to the operating instructions for the external microphone.

XLR Microphone Adaptor (Optional)

By attaching an XLR Microphone Adaptor (DMW-XLR1: optional) to the camera, you can use a commercially available XLR microphone to enable the recording of superior-quality stereo audio.

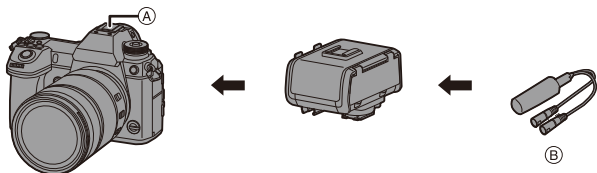

- Ⓐ Hot shoe
- Ⓑ Commercially available XLR microphone

Getting started:

- Turn off the camera, and remove the hot shoe cover. (→ 216)

Attach the XLR Microphone Adaptor to the hot shoe, and then turn on the camera.

- When the XLR Microphone Adaptor is attached, [XLR Mic Adaptor Setting] automatically turns [ON].

[ON]	Records audio using the XLR microphone.
[OFF]	Records audio using the built-in microphone.



- When [XLR Mic Adaptor Setting] is set to [ON], the following settings are fixed:
 - [Sound Rec Level Limiter]: [OFF]
 - [Wind Noise Canceller]: [OFF]
 - [Special Mic.]: [STEREO]
 - [Sound Output]: [REC SOUND]
- [Sound Rec Level Adj.] cannot be used when [XLR Mic Adaptor Setting] is set to [ON].
- When the XLR Microphone Adaptor is attached, [Sound Rec Level Disp.] automatically turns [ON], and the recording level is displayed on the screen.
- When the XLR Microphone Adaptor is attached, do not carry the camera by holding the XLR Microphone Adaptor. It may become detached.
- If noises are recorded when using the AC adaptor, use the battery.
- For details, refer to the operating instructions for the XLR Microphone Adaptor.

Headphones

You can record videos while monitoring their sound by connecting commercially available headphones to the camera.

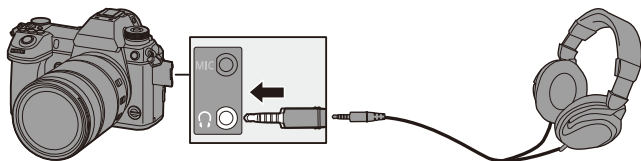

- Do not use the headphone cables with the length of 3 m (9.8 feet) or more.
- When headphones are connected, beep sounds, AF beep, and electronic shutter sounds are muted.

❖ Switching the Sound Output Method

 → [] → [] → Select [Sound Output]

[REALTIME]	Audio without time lag. It may differ from the sound recorded in videos.
[REC SOUND]	Audio to be recorded in videos. Output sound may be delayed from actual sound.



- When recording with an HDMI connection, this is fixed to [REC SOUND].

❖ Adjusting the Headphone Volume

Connect the headphones and rotate .

: Reduces the volume.



: Increases the volume.

- You can also adjust the volume by touching []/[] on the playback screen.

To adjust the volume using the menu:

1 Select [Headphone Volume].

-  → [] → [] → [Headphone Volume]

2 Press ▲▼ to adjust the headphone volume and then press  or .

- It can be adjusted in a range of [0] to [LEVEL15].

12. Playing Back and Editing of Images

This chapter explains the playing back and editing of images.

- ➔ • Refer to “[Playback] Menu” starting on page 361 for details about protection, ratings, and other playback and editing functions.

Playing Back Pictures

1 Display the playback screen.

- Press [▶].

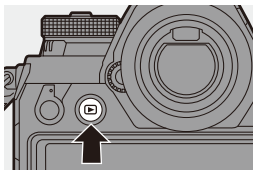

2 Select a picture.

(A) Card slot

- Select the pictures by pressing ◀▶.
 - ◀: Move to the previous image
 - ▶: Move to the next image
- You can move continuously through images by pressing and holding ◀▶.
- You can also select by rotating 🌞 or ⚙️.
- You can also move through images by dragging the screen horizontally. By leaving your finger touching the left or right edge of the screen after dragging to change the image, you can continuously move through images.
- If images are continuously moved through, the card being played back changes.



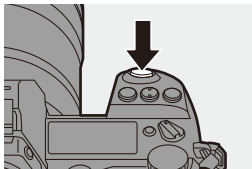

3 Stop playback.

- Press the shutter button halfway.
- You can also stop playback by pressing [▶].



❖ Switching the Card to Display

Images are displayed separately by card slot.

To switch the card to display, after pressing [⏏], press ▲▼ to select [Card Slot 1(XQD)] or [Card Slot 2(SD)], and then press  or .



- You can transfer pictures to a smartphone connected by Bluetooth by pressing [Q]. (→ 401)



- This camera complies with the “Design rule for Camera File system” (DCF) and “Exchangeable Image File Format” (Exif) standards established by “Japan Electronics and Information Technology Industries Association” (JEITA). The camera cannot play back files that do not comply with the DCF standard. Exif is a file format for pictures which allows recording information, etc. to be added.
- Images recorded on devices other than this one may not be played back or edited correctly on this camera.

Playing Back Videos

1 Display the playback screen.

- Press [▶].

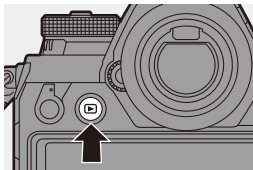

2 Select a video.

- For information about how to select images, refer to page 259.
- The [▶] video icon is displayed for a video.

- (A) Video recording time



3 Play back the video.

- Press ▲.
- You can also start playback by touching [▶] at the center of the screen.
- The elapsed playback time is displayed on the screen.

Example) When 8 minutes 30 seconds: 8m30s













- h: hour, m: minute, s: second



4 Stop playback.

- Press ▼.

❖ Operations During Video Playback

Button operation	Touch operation	Description of operation
▲		Plays/pauses.
▼		Stops.
◀		Performs fast-rewind playback. • If you press ◀ again, the fast-rewind speed increases.
		Performs frame-by-frame rewinding (while paused). • During the playback of AVCHD video, frame-by-frame rewinding will be at an approx. 0.5 second interval.
▶		Performs fast-forward playback. • If you press ▶ again, the fast-forward speed increases.
		Performs frame-by-frame forwarding (while paused).
		Extracts a picture (while paused). (→ 263)
		Reduces the volume.
		Increases the volume.



- The camera can play back videos in AVCHD and MP4 formats.
- Some information (recording information, etc.) is not displayed for an AVCHD video.
- To play back videos on a PC, use the “PHOTOfunSTUDIO” software.

Extracting a Picture



Extract one frame of a video and save it as a JPEG image.

1 Pause playback at the position you wish to extract a picture.

- Press ▲.
- To fine-adjust the position, press ◀▶ (frame-by-frame forward or frame-by-frame rewind).



2 Save the picture.

- Press  or .
- You can also perform the same operation by touching [].

- The picture created from the video is saved with a 16:9 image aspect ratio and [FINE] picture quality.
The picture size will differ depending on the video.
 - When a picture is created from a 4K video: 3840×2160
 - When a picture is created from a FHD video: 1920×1080
- The image quality of a picture created from a video may be coarser than normal.
- [] is displayed on the detailed information display screen for a picture created from a video.

Switching the Display Mode



You can use features to do things like enlarge recorded images for display and switch to thumbnail display to display multiple images at once (multi-playback).

You can also switch to Calendar display to show images of a selected recording date.

Enlarged Display



Playback images can be displayed enlarged (Playback Zoom).

Enlarging the playback screen.

- Rotate  to the right.
- The playback screen is enlarged in the order of 2× ⇨ 4× ⇨ 8× ⇨ 16×.
- Rotating  to the left returns to the previous display size.
- Pictures taken with [Picture Quality] set to [RAW] cannot be displayed enlarged at 16×.
- You cannot enlarge the edges of images recorded using [High Resolution Mode].



❖ Operations During Enlarged Display

Button operation	Touch operation	Description of operation
	—	Enlarges/reduces the screen.
—	Pinch out/ pinch in	Enlarges/reduces the screen in small steps.
	Drag	Moves the enlarged display position. Positions can be moved to the diagonal directions using the joystick.
	—	Forwards or rewinds images while maintaining the same zoom magnification and zoom position.



- You can enlarge the point focused with AF:



[] ⇒ [] ⇒ [Magnify from AF Point] (→ [363](#))

Thumbnail Screen

1 Switch to thumbnail display.

- Rotate  to the left.
- The display is switched in the order of 12-image screen \rightarrow 30-image screen.

(A) Card

- An orange frame is shown around the selected image.
- Rotating  to the left during 30-image screen display switches to calendar display. (\rightarrow 267)
- Rotating  to the right returns to the previous display.
- You can also switch the display by touching an icon.

[]: 1-image screen



[]: 12-image screen

[]: 30-image screen

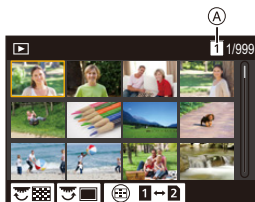
[ CAL]: Calendar (\rightarrow 267)



2 Select an image.

- Press $\blacktriangle \blacktriangledown \blacktriangleleft \blacktriangleright$ to select an image and then press  or .

❖ Switching the Card to Display

Images are displayed separately by card slot.

To switch the card to display, press [] during thumbnail display.



- You can scroll the screen by dragging the thumbnail display up or down.



- Images indicated with [] cannot be played back.

Calendar Playback







1 Switch to Calendar Playback.

- Rotate  to the left.
- The display is switched in the order of thumbnail screen (12 images)
 - ⇒ thumbnail screen (30 images)
 - ⇒ Calendar Playback.









- Rotating  to the right returns to the previous display.

2 Select the recording date.

- Press     to select a date and then press  or .
- The selected date is displayed in orange.

3 Select an image.

- Press     to select an image and then press  or .
- Rotating  to the left returns to Calendar Playback.



- The card to display cannot be switched during Calendar display.
- The recording date of the image selected in the playback screen becomes the date selected when the calendar screen is first displayed.
- The range that the calendar can be displayed is January 2000 to December 2099.





Group Images

Images recorded with Time Lapse Shot or Stop Motion Shooting are handled as group images in the camera, and can be deleted and edited on a group basis.

(For example, if you delete a group image, all images in the group are deleted.)

You can also delete and edit each image in a group individually.





❖ Images Handled as Group Images by the Camera

	Group images saved with [6K/4K PHOTO Bulk Saving].
	Group images recorded with Focus Bracket.
	Group images recorded with Time Lapse Shot.
	Group images recorded with Stop Motion Shooting.



❖ Playing and Editing the Images in a Group One by One





Operations such as the thumbnail screen, enlarged display, and deleting images are available with images in groups just as with normal picture playback.

- 1 Press [▶] to display the playback screen.
- 2 Select the group image for playback. (→ 259)
- 3 Press ▲ to display the images in the group.
 - You can also perform the same operations by touching [, [, [, and [].
- 4 Press ◀▶ to select an image.
 - To return to the normal playback screen, press ▲ or touch [] again.

Deleting Images





-  • Images cannot be restored once they have been deleted. Carefully confirm the images before deletion.
- You can only delete the images in the card of the selected card slot.
- If you delete a group image, all images in the group are deleted.

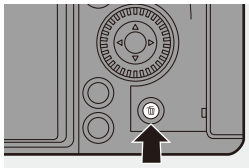







❖ [Delete Single]

- 1 Press  in playback state.
- 2 Press   to select [Delete Single] and then press  or .



❖ [Delete Multi]/[Delete All]

- 1 Press  in playback state.
- 2 Press   to select the deletion method and then press  or .

[Delete Multi]	<p>Selecting and deleting multiple images.</p> <ol style="list-style-type: none"> 1 Press     to select the image to delete and then press  or . <ul style="list-style-type: none"> •  is displayed for the selected image. • If you press  or  again, the selection is canceled. • Up to 100 images can be selected. 2 Press [DISP.] to delete the selected image.
[Delete All]	<p>Deleting all images in a card.</p> <ul style="list-style-type: none"> • If you select [Delete All], all images in the card are deleted. • If you select [Delete All Non-rating], all images except those with a rating set are deleted.





- To switch the card selected for deleting images, press [] and then select the card slot.



- Depending on the number of images to be deleted, it may take some time to delete them.



- You can register functions to Fn buttons:

[] ⇒ [] ⇒ [Fn Button Set] ⇒ [Setting in PLAY mode] ⇒ [Delete Single]
(→ 278)

[RAW Processing]

This processes pictures taken in RAW format on the camera and saves them in JPEG format.

You can also save images recorded with [HLG Photo] in the RAW format as HLG format.

1 Select [RAW Processing].

- Press **MENU/SET** → [▶] → [🖼️] → [RAW Processing]

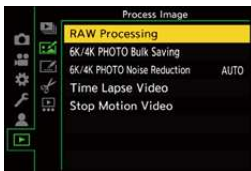

2 Select the RAW image.

- Press ◀▶ to select an image and then press **MENU/SET** or .
- When group images are selected, press ▲ and then select an image in the group. Press ▲ again to return to the normal selection screen.
- The settings from the time of recording are reflected in displayed images.



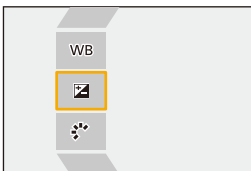

3 Select a setting item.

- Press ▲▼ to select an item and then press **MENU/SET** or .





4 Change the setting.

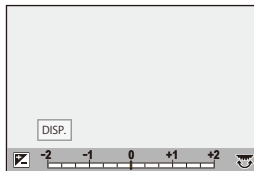



- Rotate , , or .
- The image can be enlarged/reduced by pinching out/pinching in the screen.



5 Confirm the setting.



- Press  or .
- The screen of Step 3 reappears. To set another item, repeat Steps 3 to 5.

6 Save the image.

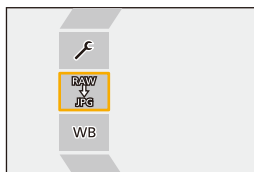
- Press   to select [Begin Processing] and then press  or .



❖ Setting Items ([RAW Processing])

[Begin Processing]	Saves the image.
[White Balance]	<p>Selects and adjusts the white balance.</p> <p>Selecting the item with [] enables processing with the same setting as at the time of recording.</p> <ul style="list-style-type: none"> • If you press ▼ in the [White Balance] selection screen, the white balance adjustment screen appears. • If you press ▲ while [] to [] of [White Balance] is selected, the color temperature setting screen appears.
[Brightness correction]	Corrects the brightness. (±2 EV)
[Photo Style]	<p>Selects a Photo Style.</p> <ul style="list-style-type: none"> • If you press [Q] while [Like709] of [Photo Style] is selected, the knee setting screen appears. • When you have selected [HLG] in [File Format] in [More Settings], only [Standard(HLG)] and [Monochrome(HLG)] are available for selection.
[i.Dynamic Range]*¹	Selects the setting of [i.Dynamic Range].
[Contrast]*¹	Adjusts the contrast. (±5)
[Highlight]*¹	Adjusts the brightness of bright portions. (±5)
[Shadow]*¹	Adjusts the brightness of dark portions. (±5)
[Saturation]*²/ [Color Tone]*³	Adjusts the saturation or color tone. (±5)
[Hue]*²	Adjusts the hue. (±5)
[Filter Effect]*³	Selects filter effects.
[Grain Effect]*⁴	Selects a grain effect setting.
[Noise Reduction]	Sets noise reduction. (±5)
[Sharpness]	Adjusts the sharpness. (±5)

[More Settings]	<p>[Revert To Original]: Returns the settings to the ones from the time of recording.</p> <p>[File Format]: Selects a file format from [JPG] or [HLG]. (Only images recorded with [HLG Photo])</p> <p>[Color Space]: Selects a Color Space setting from [sRGB] and [Adobe RGB]. (Only when [JPG] is selected in [File Format])</p> <p>[Picture Size]: Selects the size for storing images.</p> <p>[HLG View Assist (Monitor)]/[HLG View Assist (HDMI)]: Uses the same settings as [Monitor] and [HDMI] in [HLG View Assist] of the [Custom] menu. (→ 347)</p> <ul style="list-style-type: none"> • [HLG View Assist (Monitor)] and [HLG View Assist (HDMI)] can only be selected when [HLG] is selected in [File Format].
------------------------	---

- *1 Cannot be adjusted when [Like709] is selected in [Photo Style], or if [HLG] is selected in [File Format] in [More Settings].
- *2 Available when items other than [Monochrome], [L.Monochrome], [L.Monochrome D], or [Monochrome(HLG)] are selected in [Photo Style].
- *3 Available when [Monochrome], [L.Monochrome], [L.Monochrome D], or [Monochrome(HLG)] is selected in [Photo Style].
- *4 Available when [Monochrome], [L.Monochrome], or [L.Monochrome D] is selected in [Photo Style].

❖ Displaying a Comparison Screen

You can change a setting while checking the effect by displaying images with the applied setting value side by side.

❶ Press [DISP.] in the screen of Step 4.

- The image with the current setting (A) is displayed at the center.
- Touching the image with the current setting enlarges it.
Touching [↩] returns to the original display.
- A comparison screen cannot be displayed while [Noise Reduction] or [Sharpness] is selected.

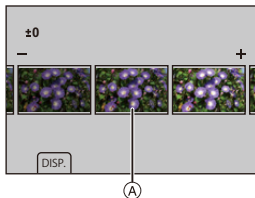

❷ Rotate , , or to change the setting.

❸ Press or to confirm the setting.





- RAW images recorded with the camera are always recorded in the [L] size of [3:2].

With this function, images are processed with the aspect ratio and the angle of view of [Ex. Tele Conv.] from the time of recording.

- When images recorded enlarged with [Ex. Tele Conv.] are processed, they cannot be processed with a [Picture Size] setting that is larger than the size at the time of recording.
- The [White Balance] item is fixed to the setting from the time of recording for pictures recorded with multiple exposures.
- The [Brightness correction] effect differs from the effect of exposure compensation during recording.
- The results of RAW processing with this function and with the “SILKYPIX Developer Studio” software do not completely match.
- RAW processing cannot be performed on the following types of RAW images:
 - Images recorded with the [High Resolution Mode]
 - Images recorded with devices other than this camera



- You can register functions to Fn buttons:

[] ⇒ [] ⇒ [Fn Button Set] ⇒ [Setting in PLAY mode] ⇒ [RAW Processing] (→ 278)

[Video Divide]

Divide a recorded video or 6K/4K burst file into two.

- Images cannot be returned to their original state once they have been divided. Carefully confirm the images before performing the divide operation.
- Do not remove the card or battery from the camera during the divide process. The images may be lost.

1 Select [Video Divide].

- Press **MENU/SET** → [] → [] → [Video Divide]



2 Select and play the images.

- Press ◀▶ to select an image and then press **MENU/SET** or .



3 Pause playback at the position you wish to divide.

- Press ▲.
- To fine-adjust the position, press ◀▶ (frame-by-frame forward or frame-by-frame rewind).

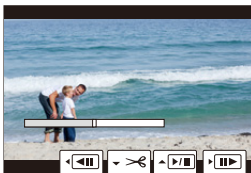

4 Divide the video.

- Press ▼.

- Dividing the video at a point close to the start or end may not be possible.
- Videos with a short recording time cannot be divided.

13. Camera Customization

This chapter explains the customization function with which you can configure the camera to your preferred settings.

Change how buttons, dials, etc. on the camera are to be operated.

Fn buttons	→ 278
Fn lever	→ 286
Dials	→ 289

Register the currently set information of the camera.

Custom mode	→ 296
-------------	-------

Change menu display items.

Quick menu customization	→ 291
My Menu registration	→ 300

Import camera settings information onto another camera.

Save/load camera settings	→ 302
---------------------------	-------

-  • Detailed settings for camera operations and screen display are available in the [Custom] menu. (→ 325)

Fn Buttons

You can register functions to the Fn (Function) buttons. Additionally, you can register other functions to specialized buttons such as [WB], in the same way as with the Fn buttons.

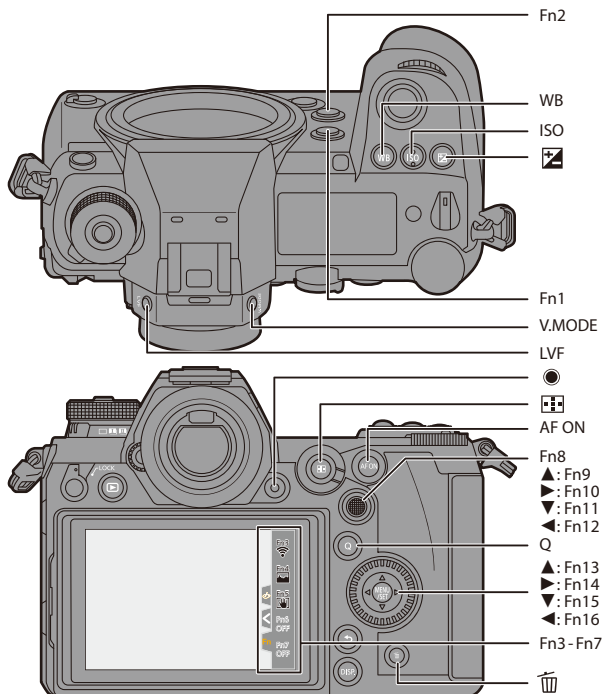

Different functions can be set for both during recording and playback.



Register Functions to the Fn Buttons





- With default settings, [Fn8] to [Fn12] on the joystick cannot be used. When using functions, set the [Joystick Setting] to [Fn]. (→ 337)

1 Select [Fn Button Set].

-  → [] → [] → [Fn Button Set] → [Setting in REC mode]/[Setting in PLAY mode]





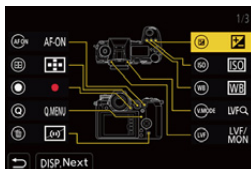

2 Select the button.

- Press ▲▼ to select the button and then press  or .
- Selection is also possible by rotating  or .







- Press [DISP.] to display [Fn1] to [Fn16]. When [Setting in PLAY mode] is selected, only [Fn1] to [Fn2] are displayed.

3 Find the function to register.

- Rotate  to select the sub tab where the function to register is categorized (→ 281, 284) and then press  or .
- You can also select by pressing ◀ to select the sub tab, pressing ▲▼ or rotating , and then pressing ▶.
- Switch the [1] to [3] tabs by pressing [Q].



4 Register the function.

- Press ▲▼ to select a function and then press  or .
- Selection is also possible by rotating  or .
- Select items with [>] by selecting the item again.
- Depending on the button, some functions cannot be registered.

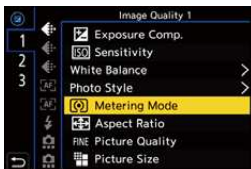









- You can also touch [Fn] on the control panel (→ 68) to display the screen in Step 2.
- You can also press and hold the Fn button (2 sec.) to display the screen in Step 4.
(This may not be displayed depending on the registered function and on the button type.)

❖ Setting Items ([Fn Button Set]/[Setting in REC mode])



[1] Tab

<p> [Image Quality]</p> <ul style="list-style-type: none"> - [Exposure Comp.] (→ 189) []* - [Sensitivity] (→ 192) [ISO]* - [White Balance] (→ 194) [WB]* - [Photo Style] (→ 199) - [Metering Mode] (→ 178) - [Aspect Ratio] (→ 82) - [Picture Quality] (→ 85) - [Picture Size] (→ 83) - [HLG Photo] (→ 214) - [High Resolution Mode] (→ 210) - [1 Shot Spot Metering] (→ 283) - [Long Exposure NR] (→ 306) - [Min. Shutter Speed] (→ 307) - [1 Shot RAW+JPG] (→ 283) - [i.Dynamic Range] (→ 307) - [Filter Effect] (→ 204) - [One Push AE] (→ 283) - [Touch AE] (→ 81) - [Exposure Mode] (→ 244) 	<p> [Focus/Shutter]</p> <ul style="list-style-type: none"> - [AF Mode/MF] (→ 98) []* - [AF Custom Setting(Photo)] (→ 96) - [AF Custom Setting(Video)] (→ 240) - [Focus Peaking] (→ 310) - [Focus Peaking Sensitivity] (→ 310) - [1-Area AF Moving Speed] (→ 311) - [Focus Ring Lock] (→ 330) - [AE LOCK] (→ 191) - [AF LOCK] (→ 191) - [AF/AE LOCK] (→ 191) - [AF-ON] (→ 94) [AF ON]* - [AF-Point Scope] (→ 94) [Fn1]* - [Focus Area Set] (→ 283) <p> [Flash]</p> <ul style="list-style-type: none"> - [Flash Mode] (→ 220) - [Flash Adjust.] (→ 224) - [Wireless Flash Setup] (→ 226) <p> [Others (Photo)]</p> <ul style="list-style-type: none"> - [Drive Mode] (→ 125) - [1 Shot "6K/4K PHOTO"] (→ 283) - [Bracketing] (→ 155) - [Silent Mode] (→ 169) - [Image Stabilizer] (→ 172) - [Shutter Type] (→ 170) - [Ex. Tele Conv.] (→ 122) - [Flicker Decrease (Photo)] (→ 315) - [Post-Focus] (→ 161)
---	--

[2] Tab

<p> [Image Format]</p> <ul style="list-style-type: none"> - [Motion Pic. Rec Format] (→ 233) - [Motion Pic. Rec Quality] (→ 234) <p> [Audio]</p> <ul style="list-style-type: none"> - [Sound Rec Level Disp.] (→ 243) - [Sound Rec Level Adj.] (→ 243) - [Mic. Directivity Adjust] (→ 254) <p> [Others (Video)]</p> <ul style="list-style-type: none"> - [Image Stabilizer] (→ 174) - [E-Stabilization (Video)] (→ 174) - [Boost I.S. (Video)] (→ 174) [Fn5]* <p> [Operation]</p> <ul style="list-style-type: none"> - [Q.MENU] (→ 71) [Q]* - [Rec / Playback Switch] (→ 283) - [Video Record] (→ 230) Video rec. button* - [LVF/Monitor Switch] (→ 67) [LVF]* - [LVF Magnification] (→ 66) [V.MODE]* - [Dial Operation Switch] (→ 290) 	<p> [Monitor / Display]</p> <ul style="list-style-type: none"> - [Preview] (→ 188) [Fn2]* - [Constant Preview] (→ 339) - [Level Gauge] (→ 339) []* - [Histogram] (→ 340) [Fn4]* - [Photo Grid Line] (→ 341) - [Live View Boost] (→ 342) - [Monochrome Live View] (→ 342) - [Night Mode] (→ 343) - [LVF/Monitor Disp. Style] (→ 283) - [Photo/Video Preview] (→ 344) - [Zebra Pattern] (→ 346) - [HLG View Assist (Monitor)] (→ 347) - [HLG View Assist (HDMI)] (→ 347) - [Sheer Overlay] (→ 347) - [I.S. Status Scope] (→ 348) <p> [Lens / Others]</p> <ul style="list-style-type: none"> - [Focus Ring Control] (→ 348) - [Zoom Control] (→ 123) <p> [Card/File]</p> <ul style="list-style-type: none"> - [Destination Card Slot] (→ 283)
---	---

[3] Tab

<p> [IN/OUT]</p> <ul style="list-style-type: none"> - [Wi-Fi] (→ 370) [Fn3]* 	<p> [Others]</p> <ul style="list-style-type: none"> - [No Setting] [Fn6] to [Fn16]* - [Restore to Default]
--	--

* Fn button default settings









• To return an Fn button to its default, select [Restore to Default].

- For details about some of the functions, refer to the section below.

[1 Shot Spot Metering]	Records with the metering mode set to [] (Spot metering) once only.
[1 Shot RAW+JPG]	Records a RAW image and a JPEG image simultaneously once only.
[One Push AE]	Adjusts the aperture value and shutter speed to the settings suited for the correct exposure determined by the camera.
[Focus Area Set]	Displays the AF area/MF Assist transition screen.
[1 Shot "6K/4K PHOTO"]	Performs 6K/4K photo recording only once.
[Rec / Playback Switch]	Switches to the playback screen.
[LVF/Monitor Disp. Style]	Switches the displayed monitor or viewfinder display style.
[Destination Card Slot]	Changes the priority of cards for recording. This can be used if [Double Card Slot Function] (→ 87) is set to [Relay Rec].

❖ Setting Items ([Fn Button Set]/[Setting in PLAY mode])

[1] Tab

<p> [Playback Mode]</p> <ul style="list-style-type: none"> – [Magnify from AF Point] (→ 363) – [HLG View Assist (Monitor)] (→ 347) <p> [Process Image]</p> <ul style="list-style-type: none"> – [RAW Processing] (→ 271) – [6K/4K PHOTO Bulk Saving] (→ 144) <p> [Add/Delete Info.]</p> <ul style="list-style-type: none"> – [Delete Single] (→ 269) – [Protect] (→ 365) – [Rating★1] (→ 365) – [Rating★2] (→ 365) – [Rating★3] (→ 365) [AF ON]* – [Rating★4] (→ 365) – [Rating★5] (→ 365) <p> [Edit Image]</p> <ul style="list-style-type: none"> – [Copy] (→ 367) 	<p> [Operation]</p> <ul style="list-style-type: none"> – [Rec / Playback Switch] (→ 285) – [LVF/Monitor Switch] (→ 67) [LVF]* – [Video Record] (→ 230) Video rec. button* <p> [Monitor / Display]</p> <ul style="list-style-type: none"> – [Night Mode] (→ 343) <p> [Card/File]</p> <ul style="list-style-type: none"> – [Card Slot Change] (→ 260) []* <p> [IN/OUT]</p> <ul style="list-style-type: none"> – [Wi-Fi] (→ 370) – [Send Image (Smartphone)] (→ 401) [Q]* – [HLG View Assist (HDMI)] (→ 347)
--	--

[2] Tab

<p> [Others]</p> <ul style="list-style-type: none"> – [6K/4K Photo Play] (→ 285) 	<ul style="list-style-type: none"> – [No Setting] [Fn1] to [Fn2]* – [Restore to Default]
--	---

* Fn button default settings

- To return an Fn button to its default, select [Restore to Default].

- For details about some of the functions, refer to the section below.



[Rec / Playback Switch]	Switches to the recording screen.
[6K/4K Photo Play]	Displays the screen to select pictures to save from a 6K/4K burst file.

Use the Fn Buttons

During recording, pressing the Fn buttons enables usage of the functions registered in [Setting in REC mode], and during playback, usage of the functions registered in [Setting in PLAY mode].

1 Press the Fn button.

2 Select a setting item.

- Press ◀▶ to select a setting item and then press  or .
- Display and selection methods of a setting item differ depending on the menu item.

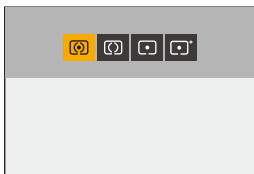

❖ Use [Fn3] to [Fn7] (Touch Icons)

During recording, you can use the Fn buttons within the Touch Tab.



- With the default settings, the Touch Tab is not displayed. Set [Touch Tab] to [ON] in [Touch Settings]. (→ 333)

- 1 Touch .
- 2 Touch one of [Fn3] to [Fn7].



Fn Lever

You can register a function with the Fn (function) lever. The registered function can be enabled instantly by toggling the Fn lever.

In default settings, [Silent Mode] is registered.

Register a Function to the Fn Lever





Register the function and setting value that operate for when the Fn lever is switched to [MODE2].

1 Set [Function of Fn Lever].

-  → [] → [] → [Fn Lever Setting] → [Function of Fn Lever]



2 Register the function.



- Press   to select a function and then press  or .



3 Press to select [MODE 2 Setting] and then press or .



4 Select a setting value.

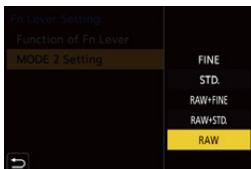

- Press ▲▼ to select a setting value and then press  or .



❖ Setting Items ([Function of Fn Lever])

– [AF Mode] (→ 98)	– [Focus Ring Lock] (→ 330)
– [Photo Style] (→ 199)	– [Touch Screen] (→ 64)
– [Picture Quality] (→ 85)	– [Touch Pad AF] (→ 115)
– [Long Exposure NR] (→ 306)	– [Auto Review (Photo)] (→ 338)
– [Focus Peaking] (→ 310)	– [Live View Boost] (→ 342)
– [Bracketing] (→ 155)	– [Night Mode] (→ 343)
– [Silent Mode]* (→ 169)	– [Sheer Overlay] (→ 347)
– [Image Stabilizer] (→ 172)	– [Front/Rear/Control Dial Lock] (→ 287)
– [Shutter Type] (→ 170)	– [No Setting]
– [Self Timer] (→ 153)	– [Restore to Default]
– [6K/4K PHOTO (Pre-Burst)] (→ 134)	

* Fn lever default setting

- To return the Fn lever to its default, select [Restore to Default].
- [Front/Rear/Control Dial Lock] is a function that can only be set in the Fn lever. It disables the operation of  /  / .

Use the Fn Lever

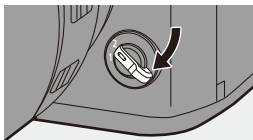
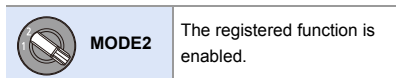

Turning the lever to the [MODE2] position enables the function registered with the Fn lever.

Switching the Fn lever.





- Depending on the recording mode and camera settings, some registered functions may not work.





[Dial Operation Switch]

This temporarily changes the functions operated with  (front dial) and  (rear dial).

Register Functions to the Dials



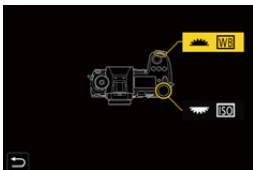

Register functions to each of  and .

1 Select [Dial Operation Switch Setup].

-  → [] → [] → [Dial Set.]
→ [Dial Operation Switch Setup] →
[]/[]



2 Register the function.

- Press   to select a function and then press  or .

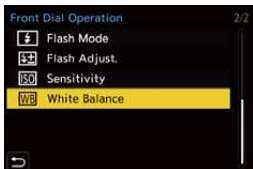

❖ Functions That Can Be Registered

– [Photo Style] (→ 199)	– [i.Dynamic Range] (→ 307)
– [Filter Effect] (→ 204)	– [Flash Mode] (→ 220)
– [Aspect Ratio] (→ 82)	– [Flash Adjust.] (→ 224)
– [AF Mode] (→ 98)	– [Sensitivity] ^{*1} (→ 192)
– [6K/4K PHOTO] (→ 130)	– [White Balance] ^{*2} (→ 194)

*1  default setting



*2  default setting

Temporarily Change Dial Operation

Use the Fn button to temporarily change dial operation.

1 Set [Dial Operation Switch] to the Fn button. (→ 278)

2 Switch dial operation.

- Press the Fn button set in Step 1.
- A guide will display the functions registered to  and .
- If no operations are performed, then several seconds later, the guide disappears.



3 Change the setting of the registered function.

- Rotate  or  while the guide is displayed.

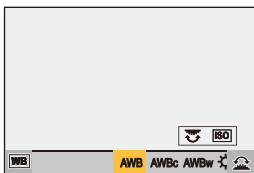

4 Confirm your selection.

- Press the shutter button halfway.

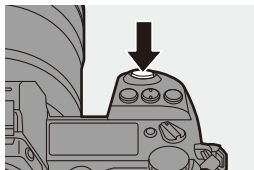

Quick Menu Customization

You can change Quick menu items depending on the recording mode. Additionally, you can change the items to display on the Quick menu and their order to suit your preferences.



For information about Quick menu operation methods, refer to page 71.

Register to the Quick Menu

Change the menus to be displayed in the Quick menu.



These can be set separately for [P/M] mode (Video) and for other recording modes (Photo).

1 Select [Q.MENU Settings].

-  ⇒ [] ⇒ [] ⇒ [Q.MENU Settings] ⇒ [Item Customize (Photo)] / [Item Customize (Video)]











2 Select the Item position (① to ⑫).

- Press ▲▼◀▶ to select the position and then press  or .
- Selection is also possible by rotating .
- Directions on the diagonal can also be selected using the joystick.









3 Find the function to register.

- Rotate  to select the sub tab where the function to register is categorized (→ 293) and then press  or .
- You can also select by pressing  to select the sub tab, pressing   or rotating , and then pressing .
- Each press of the [Q] switches between tabs [1] and [2].



4 Register menu items.

- Press   to select an item and then press  or .
- Selection is also possible by rotating  or .
- Select items with [>] by selecting the item again.







❖ Menu Items That Can Be Registered

[1] Tab



<p> [Image Quality]</p> <ul style="list-style-type: none"> - [Exposure Comp.] (→ 189) - [Sensitivity] (→ 192) - [White Balance] (→ 194) - [Photo Style] (→ 199) - [Metering Mode] (→ 178) - [Aspect Ratio] (→ 82) - [Picture Quality] (→ 85) - [Picture Size] (→ 83) - [HLG Photo] (→ 214) - [Long Exposure NR] (→ 306) - [Min. Shutter Speed] (→ 307) - [i.Dynamic Range] (→ 307) - [Filter Effect] (→ 204) - [Exposure Mode] (→ 244) <p> [Focus/Shutter]</p> <ul style="list-style-type: none"> - [AF Mode] (→ 98) - [AF Custom Setting(Photo)] (→ 96) - [AF Custom Setting(Video)] (→ 240) - [Focus Peaking] (→ 310) - [Focus Peaking Sensitivity] (→ 310) - [1-Area AF Moving Speed] (→ 311) <p> [Flash]</p> <ul style="list-style-type: none"> - [Flash Mode] (→ 220) - [Flash Adjust.] (→ 224) - [Wireless Flash Setup] (→ 226) 	<p> [Others (Photo)]</p> <ul style="list-style-type: none"> - [Drive Mode] (→ 125) - [Bracketing] (→ 155) - [Silent Mode] (→ 169) - [Image Stabilizer] (→ 172) - [Shutter Type] (→ 170) - [Ex. Tele Conv.] (→ 122) - [Flicker Decrease (Photo)] (→ 315) - [Post-Focus] (→ 161) <p> [Image Format]</p> <ul style="list-style-type: none"> - [Motion Pic. Rec Format] (→ 233) - [Motion Pic. Rec Quality] (→ 234) <p> [Audio]</p> <ul style="list-style-type: none"> - [Sound Rec Level Disp.] (→ 243) - [Sound Rec Level Adj.] (→ 243) - [Mic. Directivity Adjust] (→ 254) <p> [Others (Video)]</p> <ul style="list-style-type: none"> - [Image Stabilizer] (→ 174) - [E-Stabilization (Video)] (→ 174) - [Boost I.S. (Video)] (→ 174)
---	---



[2] Tab

 [Monitor / Display] <ul style="list-style-type: none">- [Constant Preview] (→ 339)- [Level Gauge] (→ 339)- [Histogram] (→ 340)- [Photo Grid Line] (→ 341)- [Live View Boost] (→ 342)- [Monochrome Live View] (→ 342)- [Night Mode] (→ 343)- [LVF/Monitor Disp. Set] (→ 343)- [Photo/Video Preview] (→ 344)- [Zebra Pattern] (→ 346)- [HLG View Assist (Monitor)] (→ 347)- [HLG View Assist (HDMI)] (→ 347)- [Sheer Overlay] (→ 347)- [I.S. Status Scope] (→ 348)	 [Lens / Others] <ul style="list-style-type: none">- [Focus Ring Control] (→ 348)  [Card/File] <ul style="list-style-type: none">- [Card Slot Change] (→ 260)  [IN/OUT] <ul style="list-style-type: none">- [Wi-Fi] (→ 370)  [Others] <ul style="list-style-type: none">- [No Setting]
---	---

❖ Quick Menu Detailed Settings

Change the appearance of the Quick menu and the operation of  during menu display.

 → [] → [] → Select [Q.MENU Settings]

[Layout Style]	<p>Changes the appearance of the Quick menu.</p> <p>[MODE1]: Displays the live view and the menu simultaneously.</p> <p>[MODE2]: Displays the menu in full screen.</p>
[Front Dial Assignment]	<p>Changes the operation of  in the Quick menu.</p> <p>[Item]: Selects menu items.</p> <p>[Value]: Selects setting values.</p>
[Item Customize (Photo)]	<p>Customizes the Quick menu to display when the mode dial is set to iA/P/A/S/M.</p>
[Item Customize (Video)]	<p>Customizes the Quick menu to display when the mode dial is set to .</p>

Custom Mode

C1 C2 C3



Recording modes and menu settings that match your preferences can be registered in Custom mode. You can use registered settings by switching the mode dial to [C1] to [C3] modes.

Register in Custom Mode

You can register the currently set information of the camera.

At the time of purchase, the default settings of the [P] mode menus are registered with all Custom modes.

1 Set to recording mode and menu settings of the state you wish to save.

2 Select [Save to Custom Mode].

- → → → [Save to Custom Mode]



3 Register.

- Select the save-to number and then press or .
- Press [DISP.] to change the Custom mode name.

For information on how to enter characters, refer to page [369](#).

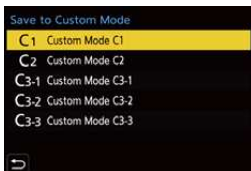

- You cannot register [iA] mode in Custom mode.



- List of settings that can be registered in Custom mode (→ [485](#))

❖ Custom Mode Detailed Settings

Set the ease of use of Custom mode.

You can create additional Custom mode sets, and how long to retain temporarily changed settings details.

 ⇒ [] ⇒ [] ⇒ Select [Custom Mode Settings]

[Limit No. of Custom Mode]	Sets the number of Custom modes that can be registered in [C3]. A maximum of 10 sets can be registered; 3 sets are available as default settings.
[Edit Title]	Changes the selected Custom mode name. A maximum of 22 characters can be entered. A two-byte character is treated as two characters. • For information on how to enter characters, refer to page 369 .
[How to Reload Custom Mode]	Sets the timing at which to return the settings that were changed temporarily while the Custom mode was being used to their registered settings. [Change Recording Mode]/[Return from Sleep Mode]/[Turn the Power ON]
[Select Loading Details]	Sets the types of settings to call with [Load Custom Mode]. [F / SS / ISO Sensitivity]: Enables calling of aperture value, shutter speed, and ISO sensitivity settings. [White Balance]: Enables calling of white balance settings.

Using Custom Mode

Set the mode dial to one of [C1] to [C3].

- If [C3], the last-used Custom mode will be called up.

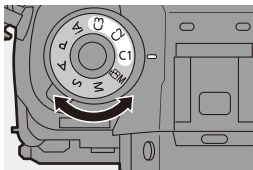

❖ [C3] Custom Mode Selection

- 1 Set the mode dial to [C3].
- 2 Press .
 - The Custom mode selection menu appears.
- 3 Press to select the Custom mode and then press or .
 - The selected Custom mode icon will be displayed on the recording screen.

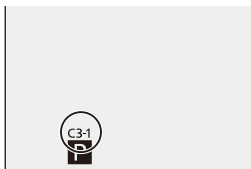

❖ Changing Registered Details

Registered settings do not change even if you change the camera settings temporarily with the mode dial set to [C1] to [C3].



To change the registered details, overwrite them by using [Save to Custom Mode] in the [Setup] ([Setting]) menu.

Calling Settings

Call registered Custom mode settings to the selected recording mode and overwrite the current settings with these.



1 Set to the mode dial to use.

2 Select [Load Custom Mode].

-  → [] → [] → [Load Custom Mode]



3 Select the Custom mode to call.

- Select the Custom mode and then press  or .

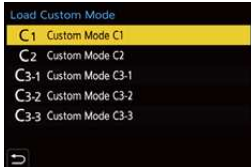



- Calling of Custom modes is not possible between those created from [P]/[A]/[S]/[M] modes and those created from [CAM] mode.

My Menu

Register frequently-used menus in My Menu.

A maximum of 23 items can be registered.

Registered menus can be called up from [] to [].

Registration in My Menu

Select a menu, and register this in My Menu.

1 Select [Add].

-  ⇒ [] ⇒ [] ⇒ [Add]



2 Register.

- Select the menu to register and then press  or .



❖ Calling up My Menu

Call up the menus registered in My Menu.

-  ⇒ [] ⇒ []/[]/[] ⇒ Registered menus

Edit My Menu

You can reorder the display order of My Menu, and delete unnecessary menus.

 ⇒ [] ⇒ Select []

[Add]	Selects and registers the menus to be displayed in My Menu.
[Sorting]	Changes the order of My Menu. Select the menu to change, then set the destination.
[Delete]	Deletes menus that are registered to My Menu. [Delete Item]: Selects the menu, then deletes. [Delete All]: Deletes all menus registered in My Menu.
[Display from My Menu]	Displays My Menu first when displaying a menu. [ON]: Displays My Menu. [OFF]: Displays the last-used menu.

[Save/Restore Camera Setting]

Saves the camera's settings information to the card.

Saved settings information can be loaded to the camera, letting you set the same settings on multiple cameras.



⇒ Select [Save/Restore Camera Setting]

Settings: [Card Slot 1(XQD)]/[Card Slot 2(SD)]

[Save]	Saves the camera's settings information to the card.	
	<ul style="list-style-type: none"> • If saving new data, then select [New File], and if overwriting an existing file, select that existing file. • When [New File] is selected, a screen to select the file name to save as is displayed. 	
	[OK]	Saves using the file name on the screen.
	[Change the file name]	Changes the file name and saves the file. <ul style="list-style-type: none"> • Available characters: alphabetic characters (upper-case), numerals, up to 8 characters • For information on how to enter characters, refer to page 369.
[Load]	Loads settings information on a card onto the camera.	
[Delete]	Deletes settings information on the card.	



- Only settings information from the same model can be loaded.
- Up to 10 instances of settings information can be saved on one card.



- List of functions for which saving of settings information is possible (→ [485](#))

14. Menu Guide

This chapter provides a menu list and default settings. Menus explained in detail in other chapters are indicated with page numbers.

- For information about menu operation methods, refer to page 73.
- For information about methods of entering characters, refer to page 369.

[Photo] Menu (→ 304)



[Setup] Menu (→ 349)



[Video] Menu (→ 318)



[My Menu] (→ 300)

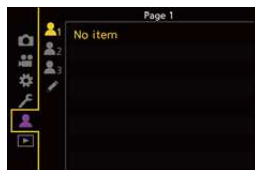













[Custom] Menu (→ 325)



[Playback] Menu (→ 361)





[Photo] Menu









 [Image Quality]	→ 305	[Flash Synchro]	→ 223
[Photo Style]	 → 199	[Manual Flash Adjust.]	→ 220
[Metering Mode]	 → 178	[Auto Exposure Comp.]	→ 225
[Aspect Ratio]	→ 82	[Red-Eye Removal]	→ 225
[Picture Quality]	→ 85	[Wireless]	→ 227
[Picture Size]	→ 83	[Wireless Channel]	→ 227
[HLG Photo]	→ 214	[Wireless FP]	→ 229
[High Resolution Mode]	→ 210	[Communication Light]	→ 229
[Long Exposure NR]	→ 306	[Wireless Setup]	→ 228
[ISO Sensitivity (photo)]	→ 306	 [Others (Photo)]	→ 313
[Min. Shutter Speed]	→ 307	[Bracketing]	→ 155
[i.Dynamic Range]	 → 307	[Silent Mode]	→ 169
[Vignetting Comp.]	 → 308	[Image Stabilizer]	 → 174
[Diffraction Compensation]	 → 308	[Burst Shot 1 Setting]	→ 126 → 130
[Filter Settings]	 → 204	[Burst Shot 2 Setting]	→ 126 → 130
 [Focus]	→ 309	[Shutter Type]	→ 170
[AF Custom Setting(Photo)]	→ 96	[Shutter Delay]	→ 314
[AF Assist Light]	→ 309	[Ex. Tele Conv.]	→ 122
[Focus Peaking]	 → 310	[Time Lapse/Animation]	→ 145 → 148
[1-Area AF Moving Speed]	 → 311	[Self Timer]	→ 153
 [Flash]	→ 311	[Flicker Decrease (Photo)]	→ 315
[Flash Mode]	→ 220	[6K/4K PHOTO]	→ 130
[Firing Mode]	→ 219	[Post-Focus]	→ 161
[Flash Adjust.]	→ 224	[Multiple Exposure]	→ 316

: Menu items common to the [Photo] menu and [Video] menu. Their settings are synchronized.



▶: Default settings









 [Image Quality]

 [Photo Style]	▶[Standard]/[Vivid]/[Natural]/[Flat]/[Landscape]/ [Portrait]/[Monochrome]/[L.Monochrome]/ [L.Monochrome D]/[Cinelike D]/[Cinelike V]/ [Like709]/[Standard(HLG)]/[Monochrome(HLG)]/ [MY PHOTO STYLE 1] to [MY PHOTO STYLE 10] You can select the finishing settings of images to suit your subjects and expression styles.	→ 199
 [Metering Mode]	▶[☉]/[☺]/[☻]/[☼] Type of optical measurement to measure brightness can be changed.	→ 178
[Aspect Ratio]	[4:3]/▶[3:2]/[16:9]/[1:1]/[65:24]/[2:1] You can select the image aspect ratio.	→ 82
[Picture Quality]	▶[FINE]/[STD.]/[RAW+ FINE]/[RAW+ STD.]/[RAW] Set the compression rate used for storing pictures.	→ 85
[Picture Size]	▶[L]/[M]/[S] Sets the picture's image size.	→ 83
[HLG Photo]	[8K-Res.]/[4K-Res.]/▶[OFF] Records an HLG format picture with a wide dynamic range.	→ 214
[High Resolution Mode]	[Start] [Simul Record Normal Shot] ▶[ON]/[OFF] [Shutter Delay] [30 SEC] to [1/8 SEC] (▶[2 SEC])/[OFF] [Motion Blur Processing] ▶[MODE1]/[MODE2] Merges pictures with a high resolution from multiple recorded images.	→ 210

 [Image Quality]      					
[Long Exposure NR]	▶[ON]/[OFF] <div style="margin-top: 10px;">  <p>The camera automatically removes noise generated when recording images with a slow shutter speed.</p> <ul style="list-style-type: none"> • The next picture cannot be taken during noise removal. • When the following functions are being used, [Long Exposure NR] is not available: <ul style="list-style-type: none"> – Video recording/[6K/4K PHOTO]/[Post-Focus] – [ELEC.] (Excluding [ELEC.+NR])/[Silent Mode]/[High Resolution Mode] • This menu item can be registered to the Fn button. (→ 278) </div>	—			
	<table border="1" style="width: 100%; border-collapse: collapse;"> <tr> <td style="width: 50%;">[ISO Auto Lower Limit Setting]</td> <td style="width: 50%;">▶[100] to [12800]</td> </tr> <tr> <td>[ISO Auto Upper Limit Setting]</td> <td>▶[AUTO]/[200] to [25600]</td> </tr> </table> <div style="margin-top: 10px;">  <p>Sets the lower and upper limits for ISO sensitivity when ISO sensitivity is set to [AUTO].</p> </div>	[ISO Auto Lower Limit Setting]	▶[100] to [12800]	[ISO Auto Upper Limit Setting]	▶[AUTO]/[200] to [25600]
[ISO Auto Lower Limit Setting]	▶[100] to [12800]				
[ISO Auto Upper Limit Setting]	▶[AUTO]/[200] to [25600]				

 [Image Quality]

<p>[Min. Shutter Speed]</p>	<p>▶[AUTO]/[1/16000] to [1/1]</p> <p>iA P A S M </p> <p>Sets the minimum shutter speed when the ISO sensitivity is set to [AUTO].</p> <ul style="list-style-type: none"> • The shutter speed may become slower than the set value in recording situations where correct exposure cannot be achieved. • This menu item can be registered to the Fn button. (→ 278) 	<p>—</p>
<p> [i.Dynamic Range]</p>	<p>[AUTO]/[HIGH]/[STANDARD]/[LOW]/▶[OFF]</p> <p>iA P A S M </p> <p>Contrast and exposure are compensated when the brightness difference between the background and subject is great, etc.</p> <ul style="list-style-type: none"> • Compensation effect may not be achieved depending on the recording conditions. • When the following functions are being used, [i.Dynamic Range] is not available: <ul style="list-style-type: none"> – [Like709]/[Standard(HLG)]/[Monochrome(HLG)] ([Photo Style]) – [Filter Settings] • This menu item can be registered to the Fn button. (→ 278) 	<p>—</p>

 [Image Quality]  →  →  						
 [Vignetting Comp.]	<p>▶[ON]/[OFF]</p> <p>iA P A S M </p> <p>When the screen periphery darkens as a result of the lens characteristics, you can record pictures with the brightness of the screen periphery corrected.</p> <ul style="list-style-type: none"> • Compensation effect may not be achieved depending on the recording conditions. • Noise in the periphery of the picture may stand out with higher ISO sensitivity. • When the following functions are being used, [Vignetting Comp.] is not available: <ul style="list-style-type: none"> – [Ex. Tele Conv.] – [High Speed Video] – [APS-C]/[PIXEL/PIXEL] ([Image Area of Video]) 	—				
 [Diffraction Compensation]	<p>[AUTO]▶[OFF]</p> <p>iA P A S M </p> <p>The camera raises the image resolution by correcting the blurriness caused by diffraction when the aperture is closed.</p> <ul style="list-style-type: none"> • Compensation effect may not be achieved depending on the recording conditions. • Noise may stand out with higher ISO sensitivity. 	—				
 [Filter Settings]	<table border="1" style="width: 100%; border-collapse: collapse;"> <tr> <td style="width: 50%;">[Filter Effect]</td> <td style="width: 50%;">[ON]▶[OFF]/[SET]</td> </tr> <tr> <td>[Simultaneous Record w/o Filter]</td> <td>[ON]▶[OFF]</td> </tr> </table> <p>This mode records with additional image effects (filters).</p>	[Filter Effect]	[ON]▶[OFF]/[SET]	[Simultaneous Record w/o Filter]	[ON]▶[OFF]	→ 204
[Filter Effect]	[ON]▶[OFF]/[SET]					
[Simultaneous Record w/o Filter]	[ON]▶[OFF]					

 **[Focus]**

[AF Custom Setting(Photo)]	▶[Set 1]/[Set 2]/[Set 3]/[Set 4]	→ 96
	Select features of AF operation when recording using [AFC] that are appropriate for the subject and scene.	
[AF Assist Light]	▶[ON]/[OFF]	—
	<div style="display: flex; justify-content: space-between; align-items: center; margin-bottom: 10px;"> iA P A S M  </div> <p>When recording in low light conditions, pressing the shutter button halfway lights the AF assist lamp, making it easier for the camera to focus.</p> <ul style="list-style-type: none"> • The effective range of the AF assist lamp is different depending on the lens used. <ul style="list-style-type: none"> – When the interchangeable lens (S-R24105) is attached and at Wide: Approx. 1.0 m (3.3 feet) to 3.0 m (9.8 feet) • Remove the lens hood. • The AF assist lamp gets slightly blocked when the interchangeable lens (S-R24105) is used, but it does not affect the performance. • The AF assist lamp may be greatly blocked, and it may become harder to focus when a lens with large diameter is used. • When [Silent Mode] is being used, [AF Assist Light] is fixed to [OFF]. 	

 **[Focus]**

▶[ON]/[OFF]

[SET]



[Focus Peaking
Sensitivity]

[Display Color]

[Display While AFS]





iA P A S M 

During MF operation, in-focus portions (portions on the screen with clear outlines) are highlighted with color.





- If the [Focus Peaking Sensitivity] is adjusted to the negative direction, portions to be highlighted are reduced, allowing you to achieve a more precise focus.
- With [Display Color], you can set the display color of the in-focus portion.
- If [Display While AFS] is set to [ON], when the shutter button is pressed halfway in focus mode [AFS], you can display Peaking.
- You can display the Touch Tab (→ [333](#)) and then touch [] in [] to switch [ON]/[OFF].
- When [Rough Monochrome] of [Filter Settings] is being used, [Focus Peaking] is not available.
- When [Live View Boost] is being used, [Focus Peaking] is not available.
- This menu item can be registered to the Fn button. (→ [278](#))

**[Focus Peaking]**



 **[Focus]**

 [1-Area AF Moving Speed]	▶[FAST]/[NORMAL]	—
	<div style="display: flex; justify-content: space-around; font-weight: bold; font-size: 1.2em;"> iA P A S M  </div> <p>Sets the speed when moving a single AF area. This operates when AF mode is set to [, [, or [].</p> <ul style="list-style-type: none"> This menu item can be registered to the Fn button. (→ 278) 	

 **[Flash]**







[Flash Mode]	▶[]/[] / [ S]/[ S [⊙]]/[]	→ 220
	Set the flash mode.	
[Firing Mode]	▶[TTL]/[MANUAL]	→ 219
	You can select whether to set the flash output automatically or manually.	
[Flash Adjust.]	[−3 EV] to [+3 EV] (▶[±0 EV])	→ 224
	When [Firing Mode] is set to [TTL], you can adjust the flash output.	
[Flash Synchro]	▶[1ST]/[2ND]	→ 223
	Sets the flash mode to Second Curtain Synchro.	
[Manual Flash Adjust.]	▶[1/1] to [1/128]	→ 220
	When [Firing Mode] is set to [MANUAL], you can set the flash output.	
[Auto Exposure Comp.]	[ON]/▶[OFF]	→ 225
	Automatically adjust the flash output in conjunction with the exposure compensation value.	

 **[Flash]**



[Red-Eye Removal]	[ON]/▶[OFF]		→ 225
	When [Flash Mode] is set to [] or [], the camera automatically detects red-eye and corrects image data.		
[Wireless]	[ON]/▶[OFF]		→ 227
	Enables recording using a wireless flash.		
[Wireless Channel]	▶[1CH]/[2CH]/[3CH]/[4CH]		→ 227
	Sets the channel to use when recording with a wireless flash.		
[Wireless FP]	[ON]/▶[OFF]		→ 229
	Uses FP firing for an external flash when recording with a wireless flash.		
[Communication Light]	▶[HIGH]/[STANDARD]/[LOW]		→ 229
	Set the strength of communication light.		
[Wireless Setup]	[External Flash]	[Firing Mode]/[Flash Adjust.]/[Manual Flash Adjust.]	→ 228
	[A Group]/[B Group]/[C Group]	[Firing Mode]/[Flash Adjust.]/[Manual Flash Adjust.]	
	Sets details for wireless flash recording.		

 [Others (Photo)]



[Bracketing]	[Bracketing Type]	/ / [FOCUS] / [WB] / [WB] / [OFF]	→ 155
	[More Settings]	You can take multiple pictures while automatically adjusting a setting.	
[Silent Mode]	[ON] / [OFF]	Disables all operation sounds and light output at once.	
	→ 169		
 [Image Stabilizer]	[Operation Mode]	/ [AUTO] / / / [OFF]	→ 172
	[Body(B.I.S.) / Lens(O.I.S.)]	[^{BODY} / ^{LENS}]	
	[When to Activate]	[ALWAYS] / [HALF-SHUTTER]	
	[E-Stabilization (Video)]	[ON] / [OFF]	
	[Boost I.S. (Video)]	[ON] / [OFF]	
	[Focal Length Set]	[0.1 mm] to [1000.0 mm] (▶[35.0 mm])	
	Configures image stabilizer settings.		
[Burst Shot 1 Setting]	/ [H] / [M] / [L]	→ 126	
	Sets the burst recording operation of the drive mode [].		→ 130
[Burst Shot 2 Setting]	▶ / [H] / [M] / [L]	→ 126	
	Sets the burst recording operation of the drive mode [].		→ 130
[Shutter Type]	[AUTO] / [MECH.] / [EFC] / [ELEC.] / [ELEC.+NR]	→ 170	
	Select the shutter type to use for taking pictures.		

 [Others (Photo)]		 →  → 
[Shutter Delay]	[8SEC]/[4SEC]/[2SEC]/[1SEC]▶[OFF]	—
	 <p>To reduce camera shake and shutter-induced blur, the shutter is released after the specified time has passed since the shutter button was pressed.</p> <ul style="list-style-type: none"> When the following functions are being used, [Shutter Delay] is not available: <ul style="list-style-type: none"> – Video recording/[6K/4K PHOTO]/[Post-Focus] – [High Resolution Mode] 	
[Ex. Tele Conv.]	[ZOOM]/[TELE CONV.]▶[OFF]	→ 122
	<p>You can take pictures that are further enlarged beyond what is available with the optical zoom, without any deterioration in image quality.</p>	
[Time Lapse/ Animation]	[Mode]	→ 145 → 148
	<div style="display: flex; justify-content: space-between;"> <div>[Time Lapse Shot]</div> <div>[Stop Motion Animation]</div> </div> <p>Time Lapse Shot automatically starts/stops recording at a set recording interval.</p> <p>Stop Motion Animation enables you to take pictures while moving the subject little by little.</p>	
[Self Timer]	▶[10]▶[10]▶[2]	→ 153
	Sets the self-timer duration.	

 [Others (Photo)]

[Flicker Decrease (Photo)]	[ON]▶[OFF]		—
	<div style="border: 1px solid black; padding: 2px; display: inline-block; margin-bottom: 5px;">iA P A S M </div> <p>Detects flickering such as that under fluorescent lighting, and records using a timing that minimizes this.</p> <ul style="list-style-type: none"> • The reduction effect may not be obtained depending on the recording conditions. • When Flicker Decrease is operating, the [FLICKER] icon will be displayed in yellow on the recording screen. • When the following functions are being used, [Flicker Decrease (Photo)] is not available: <ul style="list-style-type: none"> – Video recording/[6K/4K PHOTO]/[Post-Focus] • When the following functions are being used, [Flicker Decrease (Photo)] is not available: <ul style="list-style-type: none"> – [ELEC.]/[Silent Mode] • This menu item can be registered to the Fn button. (→ 278) 		
[6K/4K PHOTO]	[Picture Size / Burst Speed]	▶[6K 18M]/[4K H 8M]/[4K 8M]	→ 130
	[Rec Method]	▶[6K/4K Burst]/[6K/4K Burst(S/S)]/[6K/4K Pre-Burst]	
	[Pre-Burst Recording]	[ON]▶[OFF]	
	<p>Sets 6K/4K photos.</p> <p>You can save pictures extracted from a burst file taken using high-speed burst.</p>		

 [Others (Photo)]

[Post-Focus]	<p>[6K 18M]/[4K 8M]/▶[OFF]</p> <p>Taking burst pictures with the same image quality as 6K/4K photos while automatically changing the focus position.</p> <p>You can select the focus position for the picture to save after recording.</p>	<p>→ 161</p>				
[Multiple Exposure]	<p>[Start]</p> <table border="1" data-bbox="319 466 862 540"> <tr> <td>[Auto Gain]</td> <td>▶[ON]/[OFF]</td> </tr> <tr> <td>[Overlay]</td> <td>[ON]/▶[OFF]</td> </tr> </table> <p>iA P A S M </p> <p>You can apply an effect equivalent to four exposures on a single image.</p> <p>[Start]: Starts exposure for multiple exposures.</p> <p>[Auto Gain]: Automatically adjusts brightness in accordance with image count.</p> <p>[Overlay]: Allows multiple exposure for recorded RAW images. After selecting [Start], a selection screen for images to stack is displayed.</p> <ul style="list-style-type: none"> • After selecting [Start], pressing the shutter button fully starts multiple exposure. • Preview is displayed for each recording, and the following operations are available: <ul style="list-style-type: none"> – [Next] (You can also perform the same operation by pressing the shutter button halfway.) – [Retake] – [Exit]: Records the picture, and finishes multiple exposure recording. <div data-bbox="629 1053 853 1202" style="text-align: right;">  </div>	[Auto Gain]	▶[ON]/[OFF]	[Overlay]	[ON]/▶[OFF]	<p>—</p>
[Auto Gain]	▶[ON]/[OFF]					
[Overlay]	[ON]/▶[OFF]					

 [Others (Photo)]

**[Multiple Exposure]
(Continued)**

- Recording the picture will automatically stop multiple exposure recording.
- To finish multiple exposure recording before starting the recording, press [Q] on the recording screen.
- Recording information for the last-recorded image will be saved as recording information for images recorded with multiple exposures.
- [Overlay] can be set only for RAW images recorded with the camera.
- For RAW images recorded using the following functions, [Overlay] cannot be set:
 - [65:24]/[2:1] ([Aspect Ratio])
 - [HLG Photo]
- When the following functions are being used, [Multiple Exposure] is not available:
 - [Time Lapse Shot]
 - [Stop Motion Animation]
 - [High Resolution Mode]
 - [Filter Settings]
- When using APS-C lenses, [Multiple Exposure] is not available.

—





[Video] Menu









[Image Quality]	→ 319	[Audio]	→ 322
[Exposure Mode]	→ 244	[Sound Rec Level Disp.]	→ 243
[Photo Style]	→ 199	[Sound Rec Level Adj.]	→ 243
[Metering Mode]	→ 178	[Sound Rec Level Limiter]	→ 243
[ISO Sensitivity (video)]	→ 319	[Wind Noise Canceller]	→ 323
[Flicker Decrease (Video)]	→ 320	[Wind Cut]	→ 255
[i.Dynamic Range]	→ 307	[Mic Socket]	→ 253
[Vignetting Comp.]	→ 308	[Special Mic.]	→ 254
[Diffraction Compensation]	→ 308	[XLR Mic Adaptor Setting]	→ 256
[Filter Settings]	→ 204	[Sound Output]	→ 257
[Auto Exposure in P/A/S/M]	→ 321	[Monitor / Display]	→ 324
[CreativeVideo Combined Set.]	→ 246	[HDMI Rec Output]	→ 252
[Image Format]	→ 321	[Others (Video)]	→ 324
[Rec Quality]	→ 234	[Image Stabilizer]	→ 174
[High Speed Video]	→ 247	[Image Area of Video]	→ 238
[Rec. File Format]	→ 233		
[Luminance Level]	→ 241		
[Focus]	→ 322		
[AF Custom Setting(Video)]	→ 240		
[Continuous AF]	→ 239		
[Focus Peaking]	→ 310		
[1-Area AF Moving Speed]	→ 311		

: Menu items common to the [Photo] menu and [Video] menu. Their settings are synchronized.













▶: Default settings

 [Image Quality]

[Exposure Mode]	▶[P]/[A]/[S]/[M] Sets the exposure mode to use in [iM] mode.	→ 244				
 [Photo Style]	▶[Standard]/[Vivid]/[Natural]/[Flat]/[Landscape]/ [Portrait]/[Monochrome]/[L.Monochrome]/ [L.Monochrome D]/[Cinelike D]/[Cinelike V]/ [Like709]/[Standard(HLG)]/[Monochrome(HLG)]/ [MY PHOTO STYLE 1] to [MY PHOTO STYLE 10] You can select the finishing settings of images to suit your subjects and expression styles.	→ 199				
 [Metering Mode]	▶[☉]/[☺]/[☻]/[☼] Type of optical measurement to measure brightness can be changed.	→ 178				
[ISO Sensitivity (video)]	<table border="1" style="width: 100%;"> <tbody> <tr> <td data-bbox="310 731 564 816">[ISO Auto Lower Limit Setting]</td> <td data-bbox="564 731 868 816">▶[100] to [12800]</td> </tr> <tr> <td data-bbox="310 816 564 900">[ISO Auto Upper Limit Setting]</td> <td data-bbox="564 816 868 900">▶[AUTO]/[200] to [25600]</td> </tr> </tbody> </table> <div style="display: flex; justify-content: space-around; margin-top: 10px;"> iA P A S M  </div> Sets the lower and upper limits for ISO sensitivity when ISO sensitivity is set to [AUTO].	[ISO Auto Lower Limit Setting]	▶[100] to [12800]	[ISO Auto Upper Limit Setting]	▶[AUTO]/[200] to [25600]	—
[ISO Auto Lower Limit Setting]	▶[100] to [12800]					
[ISO Auto Upper Limit Setting]	▶[AUTO]/[200] to [25600]					







 [Image Quality]		 →  → 
[Flicker Decrease (Video)]	[1/50]/[1/60]/[1/100]/[1/120]▶[OFF]	—
	iA P A S M  The shutter speed can be fixed to reduce the flicker or striping in the video. • When [Auto Exposure in P/A/S/M] is [OFF], [Flicker Decrease (Video)] is not available.	
 [i.Dynamic Range]	[AUTO]/[HIGH]/[STANDARD]/[LOW]▶[OFF]	→ 307
	Contrast and exposure are compensated when the brightness difference between the background and subject is great, etc.	
 [Vignetting Comp.]	▶[ON]/[OFF]	→ 308
	When the screen periphery darkens as a result of the lens characteristics, you can record pictures with the brightness of the screen periphery corrected.	
 [Diffraction Compensation]	[AUTO]▶[OFF]	→ 308
	The camera raises the image resolution by correcting the blurriness caused by diffraction when the aperture is closed.	
 [Filter Settings]	[Filter Effect] [ON]▶[OFF]/[SET]	→ 204
	[Simultaneous Record w/o Filter] [ON]▶[OFF]	
	This mode records with additional image effects (filters).	





 **[Image Quality]**

[Auto Exposure in P/A/S/M]	▶[ON]/[OFF]		—
	 <p>Selects the setting method for aperture value, shutter speed, and ISO sensitivity for the video being recorded. (→ 231)</p> <p>[ON]: Records with values set automatically by the camera.</p> <p>[OFF]: Records with manually set values.</p>		
[CreativeVideo Combined Set.]	[F/SS/ISO/Exposure Comp.]	▶[]/[	→ 246
	[White Balance]	▶[]/[	
	[Photo Style]	▶[]/[	
	[Metering Mode]	▶[]/[	
	[AF Mode]	▶[]/[	
	Content set in [] mode can be separated from when taking pictures.		

 **[Image Format]**

[Rec Quality]	Sets the video recording image quality.	→ 234
[High Speed Video]	[180/30p FHD]/[120/30p FHD]/[60/30p 4K]/[48/23.98p 4K]/▶[OFF]	→ 247
	Records slow motion videos of MP4 format by performing ultra-high-speed recording.	
[Rec. File Format]	[AVCHD]/▶[MP4]	→ 234
	Sets the video recording file format.	
[Luminance Level]	[0-255]/▶[16-255]	→ 241
	You can set the luminance range to suit the purpose of video recording.	

 [Focus]		 →  → 	
[AF Custom Setting(Video)]	[ON]▶[OFF]		→ 240
	[SET]	[AF Speed]/ [AF Sensitivity]	
	You can fine-adjust the focusing method for video recording using [Continuous AF].		
[Continuous AF]	▶[ON]/[OFF]		→ 239
	You can select how to set the focus in AF when recording videos.		
 [Focus Peaking]	▶[ON]/[OFF]		→ 310
	[SET]	[Focus Peaking Sensitivity]	
		[Display Color]	
		[Display While AFS]	
During MF operation, in-focus portions (portions on the screen with clear outlines) are highlighted with color.			
 [1-Area AF Moving Speed]	▶[FAST]/[NORMAL]		→ 311
	Sets the speed when moving a single AF area.		

 [Audio]		 →  → 	
[Sound Rec Level Disp.]	[ON]▶[OFF]		→ 243
	The sound recording level is displayed on the recording screen.		
[Sound Rec Level Adj.]	[- 12dB] to [+6dB] (▶[0dB])		→ 243
	Manually adjust the sound recording level.		
[Sound Rec Level Limiter]	▶[ON]/[OFF]		→ 243
	The sound recording level is adjusted automatically to minimize sound distortion (crackling noise).		







 [Audio]

[Wind Noise Canceller]	[HIGH]▶[STANDARD]/[OFF]	—
	<p>iA P A S M </p> <p>This reduces the wind noise coming into the built-in microphone while maintaining sound quality.</p> <ul style="list-style-type: none"> • [HIGH] effectively reduces the wind noise by reducing the low-pitched sound when a strong wind is detected. • [STANDARD] extracts and reduces only the wind noise without deteriorating the sound quality. • You may not see the full effect depending on the recording conditions. • This function works only with the built-in microphone. <p>When an external microphone is connected, [Wind Cut] is displayed. (→ 255)</p>	
[Wind Cut]	[HIGH]/[STANDARD]/[LOW]▶[OFF]	→ 255
	This reduces wind noise when an external microphone is connected.	
[Mic Socket]	▶[MIC▼]/[MIC]/[LINE]	→ 253
	Sets the [MIC] socket input method that suits the device to be connected.	
[Special Mic.]	▶[STEREO]/[LENS AUTO]/[SHOTGUN]/[S. SHOTGUN]/[MANUAL]	→ 254
	Sets the sound pickup range when using the Stereo Shotgun Microphone (optional).	
[XLR Mic Adaptor Setting]	▶[ON]/[OFF]	→ 256
	Enables recording from the XLR Microphone Adaptor (optional).	
[Sound Output]	▶[REALTIME]/[REC SOUND]	→ 257
	Sets the audio output method when headphones are connected.	

 **[Monitor / Display]**

[HDMI Rec Output]	[Info Display]	▶[ON]/[OFF]	→ 252
	Select whether or not to output the information display of the camera to an external device connected via HDMI.		



 **[Others (Video)]**

 [Image Stabilizer]	[Operation Mode]	▶[]/[]/[]/[]/[OFF]	→ 172
	[Body(B.I.S.) / Lens(O.I.S.)]	[]▶[]	
	[When to Activate]	[ALWAYS]▶[HALF-SHUTTER]	
	[E-Stabilization (Video)]	[ON]▶[OFF]	
	[Boost I.S. (Video)]	[ON]▶[OFF]	
	[Focal Length Set]	[0.1 mm] to [1000.0 mm] ▶[35.0 mm]	
	Configures image stabilizer settings.		
[Image Area of Video]	▶[FULL]/[APS-C]/[PIXEL/PIXEL]	→ 238	
	Sets the image area during video recording.		



[Custom] Menu

[Image Quality]	→ 327	[Operation]	→ 333
[Photo Style Settings]	→ 327	[Q.MENU Settings]	→ 291
[ISO Increments]	→ 327	[Touch Settings]	→ 333
[Extended ISO]	→ 327	[Lock Lever Setting]	→ 334
[Exposure Offset Adjust.]	→ 328	[Fn Button Set]	→ 278
[Color Space]	→ 328	[Fn Lever Setting]	→ 286
[Exposure Comp. Reset]	→ 328	[WB/ISO/Expo. Button]	→ 335
[Focus/Shutter]	→ 329	[ISO Displayed Setting]	→ 335
[Focus/Shutter Priority]	→ 329	[Exposure Comp. Disp. Setting]	→ 335
[Focus Switching for Vert / Hor]	→ 116	[Dial Set.]	→ 336
[AF/AE Lock Hold]	→ 329	[Joystick Setting]	→ 337
[AF+MF]	→ 329	[Illuminated Button]	→ 337
[MF Assist]	→ 330	[Video Rec. Button (Remote)]	→ 446
[MF Guide]	→ 330		
[Focus Ring Lock]	→ 330		
[Show/Hide AF Mode]	→ 331		
[Pinpoint AF Setting]	→ 331		
[AF-Point Scope Setting]	→ 332		
[Shutter AF]	→ 332		
[Half-Press Shutter]	→ 332		
[Quick AF]	→ 332		
[Eye Sensor AF]	→ 332		
[Looped Focus Frame]	→ 333		
[AFC Start Point (225-Area)]	→ 104		

 [Monitor / Display]	→ 338
[Auto Review]	→ 338
[Constant Preview]	→ 339
[Level Gauge]	→ 339
[Histogram]	→ 340
[Photo Grid Line]	→ 341
[Framing Outline]	→ 341
[Center Marker]	→ 341
[AF Area Display]	→ 341
[Live View Boost]	→ 342
[Monochrome Live View]	→ 342
[Night Mode]	→ 343
[LVF/Monitor Disp. Set]	→ 343
[Expo.Meter]	→ 344
[Focal Length]	→ 344
[Photo/Video Preview]	→ 344
[Photos/Videos Remaining]	→ 345
[Show/Hide Monitor Layout]	→ 345
[Blinking Highlights]	→ 345
[Zebra Pattern]	→ 346
[HLG View Assist]	→ 347
[Sheer Overlay]	→ 347
[I.S. Status Scope]	→ 348
 [Lens / Others]	→ 348
[Lens Focus Resume]	→ 348
[Focus Ring Control]	→ 348

▶: Default settings

 [Image Quality]

[Photo Style Settings]	[Show/Hide Photo Style]	[Vivid]/[Natural]/[Flat]/[Landscape]/[Portrait]/[L.Monochrome]/[L.Monochrome D]/[Cinelike D]/[Cinelike V]/[Like709]/[MY PHOTO STYLE 1] to [MY PHOTO STYLE 10]
	Sets Photo Style items to be displayed on the menu.	
	[My Photo Style Settings]	[Add Effects] [Load Preset Setting]
	Enables detailed image quality adjustment settings for My Photo Style. [Add Effects]: Enables [ISO] and [WB] adjustments on the image quality adjustment screen. [Load Preset Setting]: Sets the timing at which image quality adjustment values changed in My Photo Style are returned to their registered state.	
	[Reset Photo Style]	Returns details changed in [Photo Style] and [Photo Style Settings] to their default settings.
[ISO Increments]	▶[1/3 EV]/[1 EV]	Changes the intervals between ISO sensitivity adjustment values.
[Extended ISO]	[ON]▶[OFF]	Setting of ISO sensitivity to a minimum of [ISO50] and a maximum of [ISO51200] is possible.



 [Image Quality]

[Exposure Offset Adjust.]	[Multi Metering]	[− 1EV] to [+ 1EV] (▶[±0EV])
	[Center Weighted]	[− 1EV] to [+ 1EV] (▶[±0EV])
	[Spot]	[− 1EV] to [+ 1EV] (▶[±0EV])
	[Highlight Weighted]	[− 1EV] to [+ 1EV] (▶[±0EV])
		<p>Adjusts the exposure level that is the standard correct exposure for each item of [Metering Mode].</p> <ul style="list-style-type: none"> • Adds the adjustment value from this function to the exposure compensation value (→ 189) when recording. For video recording, [6K/4K PHOTO], and [Post-Focus], it is not possible to add an adjustment value of a range that exceeds ± 3 EV.
[Color Space]	▶[sRGB]/[AdobeRGB]	
	<p>This sets the method for correcting the color reproduction of the recorded images on the screens of a PC or on a device such as a printer.</p> <p>[sRGB]: This is widely used in PCs and similar devices. [AdobeRGB]: AdobeRGB is mainly used for business purposes such as professional printing because it has a greater range of reproducible colors than sRGB.</p> <ul style="list-style-type: none"> • Set to [sRGB] if you are not very familiar with AdobeRGB. • When the following functions are being used, the setting is fixed to [sRGB]: <ul style="list-style-type: none"> – Video recording/[6K/4K PHOTO]/[Post-Focus] – [Like709] ([Photo Style]) – [Filter Settings] 	
[Exposure Comp. Reset]	[ON]/▶[OFF]	
	<p>This resets the exposure value when you change the recording mode or turn off the camera.</p>	

 **[Focus/Shutter]**

[Focus/Shutter Priority]	[AFS]	▶[FOCUS]/[BALANCE]/[RELEASE]
	[AFC]	[FOCUS]▶[BALANCE]/[RELEASE]
	<p>This sets whether to give priority to focus or shutter release during AF.</p> <p>[FOCUS]: Disables recording when focus is not achieved.</p> <p>[BALANCE]: Performs recording while controlling the balance between focusing and shutter release timing.</p> <p>[RELEASE]: Enables recording even when focus is not achieved.</p>	
[Focus Switching for Vert / Hor]	[ON]▶[OFF]	
	<p>Memorizes separate positions for AF areas for when the camera is vertically aligned and for when it is horizontally aligned.</p> <ul style="list-style-type: none"> • For details, refer to page 116. 	
[AF/AE Lock Hold]	[ON]▶[OFF]	
	<p>Turning this [ON] maintains the lock after releasing the button until it is pressed again.</p>	
[AF+MF]	[ON]▶[OFF]	
	<p>You can fine-adjust the focus manually during AF Lock by rotating the focus ring.</p> <ul style="list-style-type: none"> – When focus mode is [AFS], and the shutter button is pressed halfway – When [AF ON] is pressed – When locked using the Fn button [AF LOCK] or [AF/AE LOCK] 	

 **[Focus/Shutter]**

	[Focus Ring]	▶[ON]/[OFF]
	[AF Mode/MF]	[ON]/▶[OFF]
	[Press Joystick]	[ON]/▶[OFF]
	[MF Assist Display]	[FULL]/▶[PIP]
[MF Assist]	<p>This sets the display method of MF Assist (enlarged screen).</p> <p>[Focus Ring]: The screen is enlarged by focusing with the lens.</p> <p>[AF Mode/MF]: The screen is enlarged by pressing [].</p> <p>[Press Joystick]: Press the joystick to enlarge the display. (if [Joystick Setting] is set to [D.FOCUS Movement]) (→ 337)</p> <p>[MF Assist Display]: Sets the display method (windowed mode/full screen mode) of MF Assist (enlarged screen).</p> <ul style="list-style-type: none"> • While you are using the following functions, MF Assist will not be displayed: <ul style="list-style-type: none"> – Video recording – [6K/4K Pre-Burst] 	
	[MF Guide]	<p>[]/▶[]/[OFF]</p> <p>During MF, MF Guide, which acts as a guide to recording distance, is displayed on the screen. You can select from meters or feet for the display unit.</p>
[Focus Ring Lock]	[ON]/▶[OFF]	
	<p>This disables the focus ring operation of the interchangeable lens during MF to lock the focus.</p> <ul style="list-style-type: none"> • [MFL] is displayed on the recording screen while the focus ring is locked. • This menu item can be registered to the Fn button. (→ 278) 	

 **[Focus/Shutter]**



[Show/Hide AF Mode]	[Face/Eye/Body/ Animal Detect.]	▶[ON]/[OFF]
	[Tracking]	▶[ON]/[OFF]
	[225-Area]	▶[ON]/[OFF]
	[Zone (Vert./ Horz.)]	▶[ON]/[OFF]
	[Zone (Square)]	[ON]▶[OFF]
	[Zone (Oval)]	▶[ON]/[OFF]
	[1-Area+]	▶[ON]/[OFF]
	[Pinpoint]	▶[ON]/[OFF]
	[Custom1]	[ON]▶[OFF]
	[Custom2]	[ON]▶[OFF]
	[Custom3]	[ON]▶[OFF]
	Sets the AF mode items to be displayed on the AF mode selection screen.	
[Pinpoint AF Setting]	[Pinpoint AF Time]	[LONG]▶[MID]/[SHORT]
	[Pinpoint AF Display]	[FULL]▶[PIP]
	Changes enlarged screen settings displayed when AF mode is [+]. [Pinpoint AF Time]: Sets the time for which the screen is enlarged when the shutter button is pressed halfway. [Pinpoint AF Display]: Sets the display method (windowed mode/full screen mode) of the enlarged screen.	

[AF] [Focus/Shutter]



[AF-Point Scope Setting]	[Keep Enlarged Display]	[ON]/▶[OFF]
	[PIP Display]	[FULL]/▶[PIP]
<p>Changes the enlarged screen settings of AF-Point Scope (→ 94).</p> <p>[Keep Enlarged Display]: Setting this to [ON] maintains the enlarged screen after pressing the Fn button until it is pressed again.</p> <p>[PIP Display]: Sets the display method (windowed mode/full screen mode) of the enlarged screen.</p>		
[Shutter AF]	▶[ON]/[OFF]	
	This adjusts focus automatically when you press the shutter button halfway.	
[Half-Press Shutter]	[ON]/▶[OFF]	
	You can release the shutter quickly by pressing the shutter button halfway.	
[Quick AF]	[ON]/▶[OFF]	
	<p>When the amount of camera blur becomes small, the camera will automatically adjust the focus and focus adjustment will then be quicker when the shutter is pressed.</p> <ul style="list-style-type: none"> • The battery will drain faster than usual. • This function is not available in the following cases: <ul style="list-style-type: none"> – In preview mode – In low light situations 	
[Eye Sensor AF]	[ON]/▶[OFF]	
	<p>When looking through the viewfinder, if the eye sensor operates, then AF will function.</p> <ul style="list-style-type: none"> • [Eye Sensor AF] may not work in low light situations. 	















 **[Focus/Shutter]**

[Looped Focus Frame]	[ON]▶[OFF]
	When moving the AF area or MF Assist, this enables its position to loop from one edge to the other edge of the screen.
[AFC Start Point (225-Area)]	[ON]▶[OFF]
	When using  with the focus mode set to [AFC], you can specify at which area to start [AFC]. • For details, refer to page 104.















 **[Operation]**

[Q.MENU Settings]	[Layout Style]	▶[MODE1]/[MODE2]
	[Front Dial Assignment]	[Item]▶[Value]
	[Item Customize (Photo)]	
	[Item Customize (Video)]	
	Customizes the Quick menu. • For details, refer to page 291.	
[Touch Settings]	[Touch Screen]	▶[ON]/[OFF]
	[Touch Tab]	[ON]▶[OFF]
	[Touch AF]	▶[AF]/[AF+AE]/[OFF]
	[Touch Pad AF]	[EXACT]/[OFFSET]▶[OFF]
	Enables touch operation. [Touch Screen]: All touch operations. [Touch Tab]: Operations of tabs, such as  on the right side of the screen. [Touch AF]: Operation to optimize the focus ([AF]) for a touched subject. Alternatively, operation to optimize both the focus and brightness ([AF+AE]). (→ 113) [Touch Pad AF]: Touch pad operation during viewfinder display. (→ 115)	

 **[Operation]**

[Lock Lever Setting]	[Cursor]	▶  / 
	[Joystick]	▶  / 
	[Touch Screen]	▶  / 
	[Dial]	▶  / 
	[DISP. Button]	▶  / 
	Sets the operations to be disabled with the operation lock lever. (Only for recording screen)	
	[Cursor]: Cursor buttons, [MENU/SET] button, and 	
	[Joystick]: Joystick	
	[Touch Screen]: Touch screen	
	[Dial]:  ,  , and 	
	[DISP. Button]: [DISP.] button	
[Fn Button Set]	[Setting in REC mode]	
	[Setting in PLAY mode]	
	Registers a function to the Fn button.	
	<ul style="list-style-type: none"> • For details, refer to page 279. 	
[Fn Lever Setting]	[Function of Fn Lever]	
	[MODE 2 Setting]	
	Registers a function to the Fn lever.	
	<ul style="list-style-type: none"> • For details, refer to page 286. 	























 [Operation]

[WB/ISO/Expo. Button]	<p>[WHILE PRESSING]/[AFTER PRESSING1]▶[AFTER PRESSING2]</p> <p>This sets the operation to be performed when [WB] (White Balance), [ISO] (ISO sensitivity) or [] (Exposure Compensation) is pressed.</p> <p>[WHILE PRESSING]: Allows you to change the setting while pressing and holding the button. Release the button to confirm the settings value, and to return to the recording screen.</p> <p>[AFTER PRESSING1]: Press the button to change settings. Press the button again to confirm the settings value, and to return to the recording screen.</p> <p>[AFTER PRESSING2]: Press the button to change settings. Each press of the button switches the settings value. (Except that of exposure compensation) To confirm your selection and return to the recording screen, press the shutter button halfway.</p>
[ISO Displayed Setting]	<p>[Front/Rear Dials] ▶ [ISO/ISO] / [ / ISO] / [OFF/ISO] / [ISO/ ] / [ISO/OFF]</p> <p>Assigning [] lets you change [ISO Auto Upper Limit Setting] on the ISO sensitivity settings screen.</p>
[Exposure Comp. Disp. Setting]	<p>[Cursor Buttons (Up/Down)] []▶[OFF]</p> <p>Assigning [] lets you set exposure bracketing on the exposure compensation screen.</p> <p>[Front/Rear Dials] ▶ [ / ] / [ / ] / [OFF/ ] / [ / ] / [ /OFF]</p> <p>Assigning [] lets you adjust flash output on the exposure compensation screen.</p>

 [Operation]

[Dial Set.]	[Assign Dial (F/SS)]	▶[SET1]/[SET2]/[SET3]/[SET4]/[SET5]				
	Sets the operations to be assigned to the dials in [P]/[A]/[S]/[M] modes.					
	P↗: Program Shift, F: Aperture value, SS: Shutter speed					
			P	A	S	M
	[SET1]		P↗	F	SS	F
		P↗	F	SS	SS	
[SET2]		—	F	—	F	
		P↗	—	SS	SS	
[SET3]		—	—	SS	SS	
		P↗	F	—	F	
[SET4]		—	—	—	F	
		P↗	F	SS	SS	
[SET5]		P↗	F	SS	F	
		—	—	—	SS	
	[Rotation (F/SS)]	▶ [
Changes the rotational directions of the dials for aperture value and shutter speed adjustment.						
	[Control Dial Assignment]	▶[] ([Headphone Volume])/[]/[] ([Exposure / Aperture])/[] ([Exposure Comp.])/[] ([Sensitivity])/[] ([Focus Frame Size])				
Sets the function to be assigned to on the recording screen.						
[]/[]: In [M] mode, this assigns the operation to adjust the aperture value. In other than [M] mode, this assigns the operation of exposure compensation.						

 [Operation]

[Dial Set.] (Continued)	[Exposure Comp.]	[]/[]/[OFF]
	Assigns exposure compensation to  or  . (Except in [M] mode)	
	<ul style="list-style-type: none"> The [Assign Dial (F/SS)] setting takes priority. 	
	[Dial Operation Switch Setup]	[] []
In the Fn button [Dial Operation Switch], this sets the items to be assigned temporarily to  or  . (→ 289)		
[Rotation (Menu Operation)]	▶ []/[]/[]/[]/ []/[]/[]/[]	
Changes the rotational direction of the dials when operating menus.		
[Joystick Setting]	▶[D.FOCUS Movement]/[Fn]/[MENU]/[OFF]	
	Sets the joystick movement on the recording screen.	
	[D.FOCUS Movement]: Moves the AF area and MF Assist. (→ 112, 117)	
	[Fn]: Operates as the Fn button. [MENU]: Operates as  . Operations that can be performed by moving the joystick are disabled. [OFF]: Disables the joystick.	
[Illuminated Button]	[ON1]/▶[ON2]/[OFF]	
	Sets the lighting timing of the illumination button. The following illumination buttons light: – [] button/[] button/[] button/[] button/[DISP.] button	
	[ON1]: Buttons are always lit while the camera is turned on. [ON2]: Buttons are lit when [] is pressed. If no operations are performed for approx. 5 seconds, this turns off. [OFF]: The buttons are not lit.	

 **[Operation]**

[Video Rec. Button (Remote)]	▶[ON]/[OFF]
	<p>Disables the video rec. button on the Shutter Remote Control (optional).</p> <ul style="list-style-type: none"> For details, refer to page 446.

 **[Monitor / Display]**

[Auto Review]	[Duration Time (photo)]	[HOLD]/[5SEC] to [1SEC]▶[OFF]
	[Duration Time (6K/4K PHOTO)]	▶[HOLD]/[OFF]
	[Duration Time (Post-Focus)]	▶[HOLD]/[OFF]
	[Playback Operation Priority]	[ON]/▶[OFF]
	<p>This displays an image immediately after it is recorded.</p> <p>[Duration Time (photo)]: Sets the Auto Review when taking pictures.</p> <p>[Duration Time (6K/4K PHOTO)]: Sets the Auto Review when recording 6K/4K photos.</p> <p>[Duration Time (Post-Focus)]: Sets the Auto Review when recording with Post-Focus.</p> <p>[Playback Operation Priority]: When this is set to [ON], you can toggle the playback screen during Auto Review, or delete pictures.</p> <ul style="list-style-type: none"> If you set [Duration Time (photo)] to [HOLD], the image recorded stays displayed until the shutter button is pressed halfway. <p>[Playback Operation Priority] will be fixed to [ON].</p>	

 **[Monitor / Display]**

[Constant Preview]	[ON]▶[OFF]
	[SET] [Preview While MF Assist]
[Level Gauge]	▶[ON]/[OFF]
	<p>Displays the level gauge which is useful in correcting camera tilt.</p> <div data-bbox="381 668 899 822" data-label="Image"> </div> <p>Ⓐ Horizontal Ⓑ Vertical</p> <ul style="list-style-type: none"> • When there is no tilt, the indicator color changes to green. • Even after correcting the tilt, there may still be an error of approx. $\pm 1^\circ$. • When the camera is tilted significantly upwards or downwards, the level gauge may not be displayed correctly. • This menu item can be registered to the Fn button. <p>(→ 278)</p>

 **[Monitor / Display]**
**[Histogram]**

[ON]▶[OFF]

This displays the histogram.

Turning this [ON] displays the histogram transition screen.

Press ▲▼◀▶ to set the position.

Positions can be moved to the diagonal directions using the joystick.

- You can also move the position by dragging the histogram on the recording screen.

- A histogram is a graph that displays brightness along the horizontal axis, and the number of pixels at each brightness level on the vertical axis.



By looking at the distribution of the graph, you can determine the current exposure.

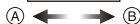















(A) Dark

(B) Bright

- When the recorded image and the histogram do not match each other under the following conditions, the histogram is displayed in orange:
 - During exposure compensation
 - When the flash fires
 - When the correct exposure is not achieved, such as in low light situations.
- The histogram is an approximation in the recording mode.
- This menu item can be registered to the Fn button. (→ 278)









 **[Monitor / Display]**

[Photo Grid Line]	<p>[]▶[OFF]</p> <p>Sets the grid line pattern to be displayed on the recording screen.</p> <p>When using [], you can press ▲▼◀▶ to set the position.</p> <p>Positions can be moved to the diagonal directions using the joystick.</p> <ul style="list-style-type: none"> • When using [], you can also drag [] on the grid lines on the recording screen to move the position. • This menu item can be registered to the Fn button. (→ 278)
[Framing Outline]	<p>[ON]▶[OFF]</p> <p>Displays the outline for the live view.</p>
[Center Marker]	<p>[ON]▶[OFF]</p> <p>The center of the recording screen will be displayed as [+].</p>
[AF Area Display]	<p>▶[ON]/[OFF]</p> <p>Displays the AF areas of [], [], [], [], and [] to [].</p> <ul style="list-style-type: none"> • AF areas are not displayed in the following cases: <ul style="list-style-type: none"> – When [AFC Start Point (225-Area)] is not used during [] – When AF area shapes are not registered in [] to [] • When the following functions are being used, [AF Area Display] is not available: <ul style="list-style-type: none"> – Video recording – [6K/4K PHOTO]







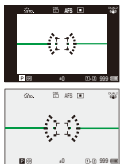

 **[Monitor / Display]**

	[MODE1]/[MODE2]/▶[OFF]
	[SET] [P/A/S/M]/▶[M]
[Live View Boost]	<p>Displays the screen brighter to make it easier to check subjects and compositions even in low-light environment.</p> <p>[MODE1]: Setting for low brightness, with priority given to a soft display.</p> <p>[MODE2]: Setting for high brightness, with priority given to image visibility.</p> <ul style="list-style-type: none"> • You can change the Recording Mode in which [Live View Boost] works by using [SET]. • This mode does not affect recorded images. • Noise may be more noticeable in the screen than in the recorded image. • This function does not work in the following cases: <ul style="list-style-type: none"> – When adjusting the exposure (when the shutter button is pressed halfway, for example) – When recording a video or 6K/4K photo – When using [Filter Settings] – When using [Constant Preview] • This menu item can be registered to the Fn button. (→ 278)
[Monochrome Live View]	[ON]/▶[OFF]
	<p>You can display the recording screen in black and white.</p> <ul style="list-style-type: none"> • If you use the HDMI output during recording, the image will not be displayed in black and white. • [Monochrome Live View] is not available when [Night Mode] is used. • This menu item can be registered to the Fn button. (→ 278)

 **[Monitor / Display]**

	[Monitor]	[ON]/▶[OFF]
	[LVF]	[ON]/▶[OFF]
[Night Mode]	<p>Displays monitor and viewfinder in red. In dark environments, this reduces brightness of the screen that can make the surroundings difficult to see. You can also set the luminance of the red display.</p> <ol style="list-style-type: none"> Press ▲▼◀▶ to select [ON] on the monitor or viewfinder (LVF). Press [DISP.] to display the brightness adjustment screen. <ul style="list-style-type: none"> Display the monitor to adjust the monitor, and display the viewfinder to adjust the viewfinder. Press ▶◀ to adjust luminance and then press  or . <ul style="list-style-type: none"> This effect is not applied to images output via HDMI. This menu item can be registered to the Fn button. (→ 278) 	
	[LVF Disp. Set]	 /▶ 
	[Monitor Disp. Set]	 /▶ 
[LVF/Monitor Disp. Set]	<p>You can select whether to display the live view in full screen or to avoid covering the information display.</p> <p>: Scales down images slightly so that you can better review the composition of the images.</p> <p>: Scales images to fill the entire screen so that you can see their details.</p>	
		

 **[Monitor / Display]**

[Expo.Meter]	[ON]▶[OFF]																	
	<p>This displays the exposure meter.</p> <div data-bbox="467 301 816 412" style="border: 1px solid black; padding: 5px; margin: 10px auto; width: fit-content;"> <table style="border-collapse: collapse; text-align: center;"> <tr> <td style="border: none;">SS</td> <td style="border: none;">125</td> <td style="border: none;">60</td> <td style="border: none;">30</td> <td style="border: none;">15</td> <td style="border: none;">8</td> </tr> <tr> <td style="border: none;">F</td> <td style="border: none;">4.0</td> <td style="border: none;">5.6</td> <td style="border: none;">8.0</td> <td style="border: none;">11</td> <td style="border: none;"></td> </tr> <tr> <td style="border: none;"></td> <td style="border: none;">30</td> <td colspan="4" style="border: none;">F5.6</td> </tr> </table> </div> <ul style="list-style-type: none"> • Set to [ON] to display the exposure meter when performing Program Shift, setting aperture, and setting shutter speed. • If no operations are performed for approx. 4 seconds, the exposure meter disappears. 	SS	125	60	30	15	8	F	4.0	5.6	8.0	11			30	F5.6		
SS	125	60	30	15	8													
F	4.0	5.6	8.0	11														
	30	F5.6																
[Focal Length]	▶[ON]/[OFF] Displays the focal length on the recording screen during zoom control.																	
[Photo/Video Preview]	▶[]/[]																	
	<p>Switches the live view angle of view.</p> <p>[]: Displays the recording area according to the angle of view for picture-taking.</p> <p>[]: Displays the recording area according to the angle of view for video recording.</p> <ul style="list-style-type: none"> • Angle of view display is a guideline. • When the following functions are being used, [Photo/Video Preview] is fixed to []: <ul style="list-style-type: none"> – [6K/4K PHOTO]/[Post-Focus] – [65:24]/[2:1] ([Aspect Ratio]) – [HLG Photo] • This menu item can be registered to the Fn button. (→ 278) 																	

 **[Monitor / Display]**

[Photos/Videos Remaining]	/	
	<p>This will switch display between the number of recordable pictures and available recording time.</p> <p> : Displays the number of recordable pictures. : Displays the available recording time for video.</p> <ul style="list-style-type: none"> • Even when this is set to , the number of recordable pictures is displayed for a while after a picture is taken. • When the following functions are being used, [Photos/Videos Remaining] is fixed to : <ul style="list-style-type: none"> – [65:24]/[2:1] ([Aspect Ratio]) – [HLG Photo] • When the following functions are being used, [Photos/Videos Remaining] operates as : <ul style="list-style-type: none"> – [6K/4K Burst]/[6K/4K Burst(S/S)]/[Post-Focus] 	
[Show/Hide Monitor Layout]	[Control Panel]	▶[ON]/[OFF]
	[Black Screen]	▶[ON]/[OFF]
Displays the control panel and black screen when switching between displays using the [DISP.] button. (→ 68)		
[Blinking Highlights]	[ON]▶[OFF]	
	<p>Overexposed areas appear blinking in black and white during Auto Review or playback.</p> <ul style="list-style-type: none"> • At the end of the playback screen transition, a non-highlighted display is added. <p>Use this to delete the highlight display. (→ 69)</p>	



 **[Monitor / Display]**

[ZEBRA1]/[ZEBRA2]▶[OFF]

[SET]

[Zebra 1]/[Zebra 2]

This indicates areas where overexposure may occur in a zebra pattern.

[ZEBRA1]**[ZEBRA2]****[Zebra Pattern]**

Select [SET] to set the brightness to be processed as a zebra pattern.

- You can select a brightness value between [50%] and [105%].

In [Zebra 2], you can select [OFF].



If you select [100%] or [105%], only the areas that are already overexposed are displayed in a zebra pattern.

The smaller the value is, the wider the brightness range to be processed as a zebra pattern will be.

- This menu item can be registered to the Fn button.

(→ 278)

 **[Monitor / Display]**

	[Monitor]	[MODE1]/▶[MODE2]/[OFF]
	[HDMI]	▶[AUTO]/[MODE1]/[MODE2]/[OFF]
[HLG View Assist]	<p>At recording or playback of [HLG Photo], this displays images with converted color gamut and brightness on the camera monitor/viewfinder, or outputs these over HDMI.</p> <p>[AUTO]: Converts images before outputting them via HDMI while applying the effect of [MODE2]. This conversion setting works only when the camera is connected to a device that does not support HDR (HLG format).</p> <p>[MODE1]: Converts with an emphasis on bright areas such as sky.</p> <p>[MODE2]: Converts with an emphasis on the brightness of a main subject.</p> <ul style="list-style-type: none"> • During the dynamic range conversion of HDR images, [MODE1] or [MODE2] is displayed on the screen. When the conversion is not performed, [HLG] is displayed. • This menu item can be registered to the Fn button. (→ 278) 	
	[ON]/▶[OFF]	
	[SET]	[Transparency]/[Image Select]/ [Reset at Power Off]
[Sheer Overlay]	<p>Displays recorded pictures by overlapping on the recording screen.</p> <ul style="list-style-type: none"> • Use [Image Select] to select the pictures to be displayed. Press ◀▶ to select pictures and then press  or  to confirm. • When the following functions are being used, [Sheer Overlay] is not available: <ul style="list-style-type: none"> – Video recording/[6K/4K PHOTO]/[Post-Focus] • This menu item can be registered to the Fn button. (→ 278) 	

 **[Monitor / Display]**

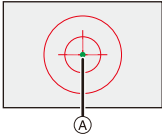
[I.S. Status Scope]	[ON]▶[OFF]	
	<p>Displays a reference point on the recording screen in order to let you check for camera shake.</p> <p>Ⓐ Reference point</p> <ul style="list-style-type: none"> When the following functions are being used, [I.S. Status Scope] is not available: <ul style="list-style-type: none"> – Video recording/[6K/4K PHOTO]/[Post-Focus] This menu item can be registered to the Fn button. (→ 278) 	
		

 **[Lens / Others]**

[Lens Focus Resume]	[ON]▶[OFF]	
	The camera saves the focus position when you turn it off.	
[Focus Ring Control]	▶[NON-LINEAR]/[LINEAR]	
	[SET]	[90°] to [360°] (▶[150°])/[Maximum]
	<p>Sets the amount of movement for focusing using the focus ring. (When using supported lenses)</p> <ul style="list-style-type: none"> The interchangeable lens (S-R24105) supplied with Lens Kit products supports this function. <p>[NON-LINEAR]: Focus responds by accelerating according to rotation speed of the focus ring.</p> <p>[LINEAR]: Focus responds at a constant amount according to the rotational angle of the focus ring.</p> <p>[SET]: Sets the rotational angle of the focus ring for when [LINEAR] is selected.</p> <ul style="list-style-type: none"> This menu item can be registered to the Fn button. (→ 278) 	





[Setup] Menu

[Card/File]	→ 350	[Setting]	→ 358
[Card Format]	→ 48	[Save to Custom Mode]	→ 296
[Double Card Slot Function]	→ 87	[Load Custom Mode]	→ 299
[Folder / File Settings]	→ 88	[Custom Mode Settings]	→ 297
[File Number Reset]	→ 90	[Save/Restore Camera Setting]	→ 302
[Copyright Information]	→ 350	[Reset]	→ 76
[Monitor / Display]	→ 351	[Others]	→ 359
[Power Save Mode]	→ 44	[Clock Set]	→ 53
[Monitor Frame Rate]	→ 351	[Time Zone]	→ 359
[LVF Frame Rate]	→ 351	[Pixel Refresh]	→ 359
[Monitor Settings]/[Viewfinder]	→ 352	[Sensor Cleaning]	→ 359
[Monitor Backlight]/[LVF Luminance]	→ 352	[Language]	→ 359
[Remaining Battery Level]	→ 352	[Firmware Version]	→ 360
[Status-LCD]	→ 353	[Online Manual]	→ 360
[Eye Sensor]	→ 353	[Approved Regulations]	→ 360
[Level Gauge Adjust.]	→ 353		
[IN/OUT]	→ 354		
[Beep]	→ 354		
[Headphone Volume]	→ 258		
[Wi-Fi]	→ 354		
[Bluetooth]	→ 354		
[USB]	→ 355		
[Battery Information]	→ 356		
[Battery Use Priority]	→ 445		
[TV Connection]	→ 357		

▶: Default settings



 **[Card/File]** →  → 

[Card Format]	[Card Slot 1(XQD)]/[Card Slot 2(SD)]	
	Formats the card (initialization). • For details, refer to page 48.	
[Double Card Slot Function]	[Recording Method]	▶  /[]/[
	This sets the way recording to the card slots 1 and 2 is performed. • For details, refer to page 87.	
[Folder / File Settings]	[Select Folder]/[Create a New Folder]/[File Name Setting]	
	Set the folder and file name where to save the images. • For details, refer to page 88.	
[File Number Reset]	[Card Slot 1(XQD)]/[Card Slot 2(SD)]	
	Resets the file number of the next recording to 0001. • For details, refer to page 90.	
[Copyright Information]	[Artist]	[ON]/▶[OFF]/[SET]
	[Copyright Holder]	[ON]/▶[OFF]/[SET]
	[Display Copyright Info.]	
	Records the names of the artist and the copyright holder in the image Exif data. • You can register names from [SET] in [Artist] and [Copyright Holder]. For information on how to enter characters, refer to page 369. • Up to 63 characters may be entered. • You can confirm registered copyright information in [Display Copyright Info.]. • Copyright information cannot be registered in AVCHD videos.	



 **[Monitor / Display]**

[Power Save Mode]	[Sleep Mode]	[10MIN.]▶[5MIN.]/[2MIN.]/[1MIN.]/ [OFF]
	[Sleep Mode(Wi-Fi)]	▶[ON]/[OFF]
	[Auto LVF/Monitor Off]	▶[5MIN.]/[2MIN.]/[1MIN.]/[OFF]
	[Power Save LVF Shooting]	[Time to Sleep]
		[Method of Activation]
<p>This is a function to automatically turn the camera to sleep (power save) status or turn off the viewfinder/monitor if no operation is performed for a set time.</p> <ul style="list-style-type: none"> • For details, refer to page 44. 		
[Monitor Frame Rate]	[30fps]▶[60fps]	
	<p>This sets the monitor frame rate.</p> <p>[30fps]: Reduces the power consumption, extending the operating time.</p> <p>[60fps]: Enables smooth display of movements.</p>	
[LVF Frame Rate]	▶[60fps]/[120fps]	
	<p>This sets the viewfinder frame rate.</p> <p>[60fps]: Reduces the power consumption for a longer operating time.</p> <p>[120fps]: Enables smooth display of movements.</p> <ul style="list-style-type: none"> • [LVF120] is displayed on the viewfinder when it is displayed at [120fps]. • When the following functions are being used, the camera displays in [60fps]: <ul style="list-style-type: none"> – Video recording – Playback – [CAM] mode – [6K/4K PHOTO] – HDMI output 	

 **[Monitor / Display]**

[Monitor Settings]/ [Viewfinder]	<p>[Brightness]/[Contrast]/[Saturation]/[Red Tint]/[Blue Tint]</p> <p>This adjusts the brightness, coloring, and red or blue tints of the monitor/viewfinder.</p> <ol style="list-style-type: none"> 1 Press ▲▼ to select the setting item, and press ◀▶ to adjust. 2 Press  or  to confirm the setting. <ul style="list-style-type: none"> • It will adjust the monitor when the monitor is in use, and the viewfinder when the viewfinder is in use.
[Monitor Backlight]/ [LVF Luminance]	<p>▶[AUTO]/[-3] to [+3]</p> <p>Adjusts monitor/viewfinder luminance.</p> <p>[AUTO]: The brightness is adjusted automatically depending on how bright it is around the camera.</p> <ul style="list-style-type: none"> • Adjusts the monitor luminance when displaying the monitor, and the viewfinder luminance when displaying the viewfinder. • When either [AUTO] is set, or the adjusted value is set to positive side, the usage period will shorten. • [AUTO] is not available on the playback screen. • When [Night Mode] is being used, [Monitor Backlight]/[LVF Luminance] are not available.
[Remaining Battery Level]	<p>▶[]/[%]</p> <p>Switches the battery remaining level display between a bar and a percentage (%) display.</p>

 **[Monitor / Display]**

[Status-LCD]	[Backlight]	▶[H]/[L]/[OFF]
	Sets the lighting method of the status LCD backlight. [H]: Brightens the status LCD backlight. [L]: Darkens the status LCD backlight. [OFF]: Turns off the status LCD backlight.	
	[Display While Power Off]	▶[ON]/[OFF]
When set to [ON], this displays the following information on the status LCD even when the camera is turned off: <ul style="list-style-type: none"> – Battery indication – Card slot – Number of recordable pictures/Recordable time – Wireless (Wi-Fi/Bluetooth) connection state – Charging/charging complete/charging error displays 		
[Eye Sensor]	[Sensitivity]	▶[HIGH]/[LOW]
	This will set the sensitivity of the eye sensor.	
	[LVF/Monitor Switch]	▶[LVF/MON AUTO] (automatic viewfinder/monitor switching)/ [LVF] (viewfinder)/ [MON] (monitor)
This will set the method for switching between the viewfinder and monitor. <ul style="list-style-type: none"> • If you press [LVF] to switch the display, the [LVF/Monitor Switch] setting will also switch. 		
[Level Gauge Adjust.]	[Adjust.]	
	Hold the camera in a horizontal position, and press  or  . The level gauge will be adjusted.	
	[Level Gauge Value Reset]	
Restores the default level gauge setting.		



[Beep]	[Beep Volume]	[🔊] (High)/▶[🔊] (Low)/[🔊] (Off)
	[AF Beep Volume]	[🎵] (High)/▶[🎵] (Low)/[🎵] (Off)
	[AF Beep Tone]	▶[🎵①] (Pattern 1)/[🎵②] (Pattern 2)/ [🎵③] (Pattern 3)
	[E-Shutter Vol]	[🔊] (High)/▶[🔊] (Low)/[🔊] (Off)
	[E-Shutter Tone]	▶[🎵①] (Pattern 1)/[🎵②] (Pattern 2)/ [🎵③] (Pattern 3)
	Sets the beep sounds, AF beep, and electronic shutter sounds.	
	<ul style="list-style-type: none"> When [Silent Mode] is being used, [Beep Volume], [AF Beep Volume], and [E-Shutter Vol] are [OFF]. 	
[Headphone Volume]	[0] to [LEVEL15] (▶[LEVEL3])	Adjusts the volume when headphones are connected.
	<ul style="list-style-type: none"> For details, refer to page 258. 	
[Wi-Fi]	[Wi-Fi Function] (→ 370)	
	[Wi-Fi Setup] (→ 421)	
[Bluetooth]	[Bluetooth] (→ 374)	
	[Send Image (Smartphone)] (→ 399)	
	[Remote Wakeup] (→ 393)	
	[Returning from Sleep Mode] (→ 387)	
	[Auto Transfer] (→ 390)	
	[Location Logging] (→ 392)	
	[Auto Clock Set] (→ 394)	
	[Wi-Fi network settings]	
	[Wi-Fi network settings]: Registers the Wi-Fi access point. Wireless access points used to connect the camera to Wi-Fi networks will be registered automatically.	



[USB]	[USB Mode]	▶ [Select on connection]/ [PC(Storage)]/ [PC(Tether)]/ [PictBridge(PTP)]
	This sets the communication method to be used when the USB connection cable is connected.	
	<p> [Select on connection]: Select this setting to select the USB communication system when connecting to another device.</p> <p> [PC(Storage)]: Select this setting to export images to a connected PC.</p> <p> [PC(Tether)]: Select this setting to control the camera from a PC installed with "LUMIX Tether".</p> <p> [PictBridge(PTP)]: Select this setting when connecting to a printer that supports PictBridge.</p>	
	[USB Power Supply]	▶ [ON]/[OFF]
Provides power from the USB connection cable. (→ 40)		
<ul style="list-style-type: none"> • Even if this item is set to [OFF], power will be supplied when the AC adaptor is connected. 		



[Battery Information]

Displays the remaining level and degree of deterioration of the battery.

If the usage duration drops significantly even when the battery is fully charged, then the battery is at the end of its service life.

Check its status, and replace with a new battery.



[Remaining Level]: Displays the battery remaining level as a percentage (1% units) and as a bar.

[Battery Health]:

- ■ ■ ■ (Green): No deterioration
- ■ ■ (Green): Slight deterioration
- ■ (Green): Moderate deterioration
- (Red): Significant deterioration. Replace with a new battery.

- Batteries have lower rechargeable capacity in colder ambient temperatures. Even if a new battery is charged at around 5 °C (41 °F) or below, [Battery Information] may show significant deterioration. When this is again charged with a temperature range from 10 °C to 30 °C (50 °F to 86 °F), the indication for the degree of deterioration returns to “No deterioration”.

[Battery Use Priority]

[BODY] ▶ [BG]

Selects which battery to use first when the batteries are installed in both the camera and the Battery Grip.

- For details, refer to page [445](#).







[TV Connection]	[HDMI Mode (Playback)]	▶[AUTO]/[4K/60p]/[4K/30p]/[1080p]/[1080i]/[720p]/[480p]
	Sets the output resolution during HDMI connection.	
	<p>[AUTO]: Outputs images at an output resolution suited to the connected TV.</p> <ul style="list-style-type: none"> • If no image appears on the TV with [AUTO], switch to a constant setting other than [AUTO] to set a format supported by your TV. (Refer to the operating instructions for the TV.) 	
	[HLG View Assist (HDMI)]	▶[AUTO]/[MODE1]/[MODE2]/[OFF]
At recording or playback of [HLG Photo], this converts its color gamut and brightness for display.		
<ul style="list-style-type: none"> • This is linked with [HDMI] in [HLG View Assist] under the [Custom] ([Monitor / Display]) menu. For details, refer to page 347. 		
[VIERA Link (CEC)]	[ON]▶[OFF]	
You can use the device remote control to operate the camera when it is connected to a VIERA Link compatible device using an HDMI cable.		
<ul style="list-style-type: none"> • For details, refer to page 428. 		



 [Setting]

[TV Connection] (Continued)	[Background Color(Playback)]	[■]/▶[■]
	Sets the color of the bands displayed on the top and bottom or the left and right of images output on a TV or similar display. <ul style="list-style-type: none"> • We recommend setting to [■] to prevent burn-in on the screen of the output destination. 	
[Save to Custom Mode]	[C1]/[C2]/[C3-1] to [C3-10]	
	You can register the currently set information of the camera. <ul style="list-style-type: none"> • For details, refer to page 296. 	
[Load Custom Mode]	[C1]/[C2]/[C3-1] to [C3-10]	
	Calls registered Custom mode settings to the selected recording mode and overwrites the current settings with these. <ul style="list-style-type: none"> • For details, refer to page 299. 	
[Custom Mode Settings]	[Limit No. of Custom Mode]	
	[Edit Title]	
	[How to Reload Custom Mode]	
	[Select Loading Details]	
	Set the ease of use of Custom mode. <ul style="list-style-type: none"> • For details, refer to page 297. 	
[Save/Restore Camera Setting]	[Card Slot 1(XQD)]	[Save]/[Load]/[Delete]
	[Card Slot 2(SD)]	[Save]/[Load]/[Delete]
	Saves the camera's settings information to the card. Saved settings information can be loaded to the camera, letting you set the same settings on multiple cameras. <ul style="list-style-type: none"> • For details, refer to page 302. 	
[Reset]	Returns the camera to its default settings. <ul style="list-style-type: none"> • For details, refer to page 76. 	

 [Others]

[Clock Set]	<p>Sets the date and time.</p> <ul style="list-style-type: none"> For details, refer to page 53.
[Time Zone]	<p>Sets the time zone.</p> <p>Press ◀▶ to select the time zone and then press  or  to confirm.</p> <p>(A) Current time (B) Time difference from GMT (Greenwich Mean Time)</p>  <ul style="list-style-type: none"> If you are using Daylight Savings [, press ▲. (The time will move forward by 1 hour.) To return to the normal time, press ▲ again.
[Pixel Refresh]	<p>This optimizes the image sensor and image processing.</p> <ul style="list-style-type: none"> The image sensor and image processing are optimized when the camera is purchased. Use this function when bright spots that do not exist in the subject get recorded. Turn the camera off and on after the pixels are corrected.
[Sensor Cleaning]	<p>Dust reduction to blow off the debris and dust that have affixed to the front of the image sensor is performed.</p> <ul style="list-style-type: none"> The dust reduction function will operate automatically when you set the camera on/off switch to [ON], but you can use this function when the dust is particularly noticeable.
[Language]	<p>This set the language displayed on the screen.</p> <ul style="list-style-type: none"> If you set a different language by mistake, select [] from the menu icons to set the desired language.



<p>[Firmware Version]</p>	<p>[Firmware Update]/[Software info]</p> <p>You can check the firmware versions of the camera and lens.</p> <p>In addition, you can update the firmware, and display information about the camera software.</p> <p>[Firmware Update]: Updates firmware.</p> <ol style="list-style-type: none"> 1 Download the firmware from the site on page 17. 2 Save the firmware to the root directory of the card (the first folder that appears when you access the card on your PC), and then insert the card into the camera. 3 From [Firmware Version], select [Firmware Update], press  or , and then select [Yes] to update the firmware. <p>[Software info]: Displays information about the camera software.</p> <ul style="list-style-type: none"> • When a supported optional item (XLR Microphone Adaptor, etc.) is attached to the camera, you can also check its firmware version.
<p>[Online Manual]</p>	<p>[URL display]/[QR Code display]</p> <p>Displays the URL or QR code in order to download the "Owner's Manual" (PDF format).</p>
<p>[Approved Regulations]</p>	<p>Displays the certification number for radio regulations.</p>



[Playback] Menu

[Playback Mode]	→ 363	[Add/Delete Info.]	→ 365
[Rotate Disp.]	→ 363	[Protect]	→ 365
[Picture Sort]	→ 363	[Rating]	→ 365
[Magnify from AF Point]	→ 363	[Edit Image]	→ 366
[HLG View Assist (Monitor)]	→ 363	[Resize]	→ 366
[Process Image]	→ 364	[Rotate]	→ 366
[RAW Processing]	→ 271	[Video Divide]	→ 276
[6K/4K PHOTO Bulk Saving]	→ 144	[Copy]	→ 367
[6K/4K PHOTO Noise Reduction]	→ 140	[Others]	→ 368
[Time Lapse Video]	→ 364	[Delete Confirmation]	→ 368
[Stop Motion Video]	→ 364		







- Images recorded by another device may not be correctly played back or edited with the camera.

❖ How to Select an Image(s) in the [Playback] menu

Follow the steps below when the image selection screen is displayed.







- When [Single] and [Multi] are not available, select an image in the same way as when [Single] is selected.
- Images are displayed separately by card slot.
To switch the card to display, press [] and select the card slot.
- You can only select images on one card at a time.

When [Single] has been selected

- 1 Press  to select the image.
- 2 Press  or .
 - If [Set/Cancel] is displayed at the right bottom of the screen, the setting is canceled when  or  is pressed again.









When [Multi] has been selected

- 1 Press    to select the image and then press  or  (repeat).
 - The setting is canceled when  or  is pressed again.
- 2 Press [DISP.] to execute.



When [Protect] is selected

Press    to select the image, and then press  or  to set (repeat).

- The setting is canceled when  or  is pressed again.







▶: Default settings





 [Playback Mode]

[Rotate Disp.]	<p>▶[ON]/[OFF]</p> <p>Automatically displays pictures vertically if they were recorded when holding the camera vertically.</p> <ul style="list-style-type: none"> When you play back pictures on a PC, use an OS and software that support Exif. The picture may not be displayed as rotated.
[Picture Sort]	<p>[FILE NAME]▶[DATE/TIME]</p> <p>This sets the order in which the camera displays images during playback.</p> <p>[FILE NAME]: Displays images by folder name/file name. [DATE/TIME]: Displays images by recording date.</p> <ul style="list-style-type: none"> If you insert another card, it may take some time to read all data, therefore pictures may not be displayed in the set order.
[Magnify from AF Point]	<p>[ON]▶[OFF]</p> <p>Enlarges the AF focus location when enlarging the image.</p> <ul style="list-style-type: none"> If the image was recorded in [High Resolution Mode] or is out of focus, the center of the image is enlarged. This menu item can be registered to the Fn button. (→ 278)
[HLG View Assist (Monitor)]	<p>[MODE1]▶[MODE2]/[OFF]</p> <p>At recording or playback of [HLG Photo], this converts its color gamut and brightness for display.</p> <ul style="list-style-type: none"> This is linked with [Monitor] in [HLG View Assist] under the [Custom] ([Monitor / Display]) menu. For details, refer to page 347.







 **[Process Image]**

[RAW Processing]	Processes pictures taken in RAW format on the camera and saves them in JPEG format. In addition, RAW images recorded using [HLG Photo] can be saved in HLG format. <ul style="list-style-type: none"> • For details, refer to page 271.
[6K/4K PHOTO Bulk Saving]	You can save any 5 second period of pictures from a 6K/4K burst file all at once. <ul style="list-style-type: none"> • For details, refer to page 144.
[6K/4K PHOTO Noise Reduction]	<p>▶[AUTO]/[OFF]</p> <p>When saving pictures, reduce the noise that occurs due to high ISO sensitivity.</p> <ul style="list-style-type: none"> • For details, refer to page 140.
[Time Lapse Video]	<p>This creates videos from group images recorded with [Time Lapse Shot].</p> <ol style="list-style-type: none"> 1 Press ◀▶ to select a [Time Lapse Shot] group and then press  or . 2 Select the options for creating a video to combine the pictures into a video. <ul style="list-style-type: none"> • For details, refer to page 151.
[Stop Motion Video]	<p>This creates videos from group images recorded with [Stop Motion Animation].</p> <ol style="list-style-type: none"> 1 Press ◀▶ to select the Stop Motion Animation group and then press  or . 2 Select the options for creating a video to combine the pictures into a video. <ul style="list-style-type: none"> • For details, refer to page 151.

 **[Add/Delete Info.]**

[Protect]	<p>[Single]/[Multi]/[Cancel]</p> <p>You can set protection for images so that they will not be deleted by mistake.</p> <p>However, if you format the card, the protected images will also be deleted.</p> <ul style="list-style-type: none"> • For information about how to select images, refer to page 362. • [Cancel] only allows to cancel settings at once for the images in a single card. • Be careful because the [Protect] setting may be disabled on a device other than this camera. • This menu item can be registered to the Fn button. (→ 278)
[Rating]	<p>[Single]/[Multi]/[Cancel]</p> <p>If you set any of the five different rating levels for images, you can do the following:</p> <ul style="list-style-type: none"> • Deleting all images except for those with ratings. • Check the rating level in the file details display in operating systems such as Windows 10, Windows 8.1, and Windows 8. (JPEG images only) <ol style="list-style-type: none"> 1 Select an image. (→ 362) 2 Press   to select a rating level (1 to 5) and then press  or . <ul style="list-style-type: none"> • When [Multi] is selected, repeat Steps 1 and 2. • To cancel the setting, set the rating level to [OFF]. • [Cancel] only allows to cancel settings at once for the images in a single card. • AVCHD videos can be set to “5” only. • This menu item can be registered to the Fn button. (→ 278)

 [Edit Image]

<p>[Resize]</p>	<p>[Single]/[Multi]</p> <p>Reduce the picture size of JPEG images and save them as different images to enable them to be easily used for web pages or sent as email attachments.</p> <ul style="list-style-type: none"> • For information about how to select images, refer to page 362. <ul style="list-style-type: none"> – When [Single] is selected, after choosing the image, press ▲▼ to select the size, then press  or . – When [Multi] is selected, before choosing the images, press ▲▼ to select the size, then press  or . • You can set up to 100 images at once with [Multi]. • The image quality of the resized image becomes lower. • [Resize] is not available while you are using the following functions: <ul style="list-style-type: none"> – Video recording/[6K/4K PHOTO]/[Post-Focus] – Group images – [65:24]/[2:1] ([Aspect Ratio]) – [RAW] ([Picture Quality]) – [HLG Photo] – [High Resolution Mode]
<p>[Rotate]</p>	<p>Rotate images manually in 90° steps.</p> <p>: Rotates 90° clockwise.</p> <p>: Rotates 90° counter-clockwise.</p> <ul style="list-style-type: none"> • For information about how to select images, refer to page 362.
<p>[Video Divide]</p>	<p>Divide a recorded video or 6K/4K burst file into two.</p> <ul style="list-style-type: none"> • For details, refer to page 276.

✂ [Edit Image]



[Copy]

[Copy Direction]

▶ [1 → 2] / [2 → 1]

[Select Copy]/[Copy All in Folder]/[Copy All in Card]

You can copy the images in one of the cards to the other card.

- Copied images will be saved in a new folder.



[Select Copy]: Copies selected images.

1 Select the folder containing the images to copy.

2 Select the images. (→ 362)

[Copy All in Folder]: Copies all images in a folder.

1 Select the folder to copy.

2 Check the images to be copied and then press  or  to execute copying.

[Copy All in Card]: Copies all images in the card.

Using the Fn button to copy images

If you press the Fn button with [Copy] assigned while playing back images one at a time, the image currently being played back will be copied to the other card.

- Select the copy destination folder from the following options. In the case of group images, [Create a New Folder] is selected automatically.

[Same Folder Number as Source]: Copies to a folder with the same name as the folder of the image to be copied.

[Create a New Folder]: Creates a new folder with an incremented folder number and then copies the image to it.

[Select Folder]: Selects a folder to store the image and then copies the image to it.

 **[Edit Image]**

**[Copy]
(Continued)**

- You can set up to 100 images at once with [Select Copy].
- The [Protect] setting is not copied.
- Copying may take a while.
- AVCHD videos cannot be copied.
- When using the following combinations of cards, videos, 6K/4K photos, and images recorded with [Post-Focus] cannot be copied:
 - Copying from an SDXC memory card to an XQD card of 32 GB or less
 - Copying from an XQD card of over 32 GB to an SD memory card or SDHC memory card

 **[Others]**

**[Delete
Confirmation]**

["Yes" first]/▶["No" first]

This sets which option, [Yes] or [No], will be highlighted first when the confirmation screen for deleting an image is displayed.



["Yes" first]: [Yes] is highlighted first.

["No" first]: [No] is highlighted first.

Entering Characters







Follow the steps below when the character entry screen is displayed.

1 Enter characters.



- Press ▲▼◀▶ to select characters and then press  or  until the character to enter is displayed.

(Repeat this)



- To repeatedly enter the same character, rotate  or  to the right to move the entry position cursor.
- If you select an item and press  or , you can perform the following operations:
 - []: Change the character type to [A] (upper case characters), [a] (lower case characters), [1] (numbers), and [&] (special characters)
 - []: Enter a blank
 - [Delete]: Delete a character
 - [<]: Move the entry position cursor to the left
 - [>]: Move the entry position cursor to the right



2 Complete entering.

- Select [Set] and then press  or .

15. Wi-Fi/Bluetooth

Wi-Fi/Bluetooth Functions

Using the camera Wi-Fi®/Bluetooth® functionality, you can remotely operate the camera from a smartphone, and transfer images to a smartphone by the camera operation.

	You can use the “LUMIX Sync” smartphone app for remote recording and image transfers. (→ 372)
	You can transfer images to another device, such as a smartphone or PC, by operating the camera. (→ 396)

This document refers to both smartphones and tablets as **smartphones**.

❖ Wireless Icon Display

During usage of the Wi-Fi/Bluetooth functions, the wireless icon on the status LCD will be lit or blink.



Lights	Wi-Fi/Bluetooth function is on, or connecting
Blinking	Image data from camera operation is being sent





- Do not remove the card or battery or move to an area without any reception while sending images.
- The camera cannot be used to connect to a public wireless LAN connection.
- We strongly recommend that you set an encryption to maintain information security.
- We recommend that you use a sufficiently charged battery when sending images.
- When the remaining battery level is low, it may not be possible to connect to or maintain communication with other devices.
(A message such as [Communication error] is displayed.)
- Images may not be completely sent depending on radio wave conditions.
If the connection is terminated while sending images, images with missing parts may be sent.

Connecting to a Smartphone

Connect with a smartphone which has the “Panasonic LUMIX Sync” (below: “LUMIX Sync”) smartphone app installed.

Use “LUMIX Sync” for remote recording and image transfers.

Connecting to a smartphone

1	Install “LUMIX Sync” on your smartphone. (→ 373) Connect to a network, and install “LUMIX Sync”  .	
2	Connect to a smartphone. Connect the camera and the smartphone using a method depending on the smartphone.	
	Using a smartphone that supports Bluetooth Low Energy • Bluetooth connection (→ 374) Connect using simple connection setup procedure (pairing).	Using a smartphone that does not support Bluetooth Low Energy • Wi-Fi connection (→ 377) Connect with Wi-Fi. You can also use a QR code to connect easily.
3	Operate the camera using the smartphone. (→ 383) Using “LUMIX Sync” to carry out the following operations: <ul style="list-style-type: none"> • [Remote shooting] (→ 384) • [Shutter Remote Control] (→ 386) • Transferring Recorded Images (→ 388) • Transferring Recorded Images Automatically (→ 390) • Recording Location Information (→ 392) • Camera Power Operations (→ 393) • Automatically Setting the Clock (→ 394) • Saving Settings Information (→ 395) <div style="display: flex; justify-content: space-around; align-items: center;">   </div>	

Connections between the camera and a smartphone are described on pages 374 to 381.

You can also use the camera to transfer images to a smartphone.

For details, refer to “Sending Images from the Camera” on page 396.

Installing “LUMIX Sync”

“LUMIX Sync” is an application for smartphones provided by Panasonic.

Supported OS

Android™: Android 5 or higher

iOS: iOS 11 or higher

- 1** Connect the smartphone to a network.
- 2** (Android) Select “Google Play™ Store”.
(iOS) Select “App Store”.
- 3** Enter “Panasonic LUMIX Sync” or “LUMIX” into the search box.
- 4** Select and install the “Panasonic LUMIX Sync” .



- Use the latest version.
- Supported OSs are current as of January 2019 and are subject to change.
- Some of the screens and information provided in this document may differ from your device depending on the supported OS and “LUMIX Sync” version.
- Read the [Help] in the “LUMIX Sync” menu for further details on how to operate.
- The app may not operate correctly depending on your smartphone.

For information on the “LUMIX Sync”, refer to the support site below.

<https://panasonic.jp/support/global/cs/dsc/>

(English only)

- Depending on your data plan, downloading the app or transferring pictures and videos via a mobile network, such as 4G (LTE) or 3G, may incur high data usage charges.



Connecting to a Smartphone (Bluetooth Connection)

Follow a simple connection setup procedure (pairing) to connect to a smartphone that supports Bluetooth Low Energy.

When pairing is set up, the camera also automatically connects to the smartphone via Wi-Fi.

- For the first-time connection, pairing settings are required.

For information about connecting for the second and subsequent times, refer to page 376.

Supported smartphones

Android™: Android 5 or higher with Bluetooth 4.0 or higher
(excluding those that do not support Bluetooth Low Energy)

iOS: iOS 11 or higher

1 On the smartphone, start up “LUMIX Sync”.

- A message regarding device (camera) registration is displayed. Select [Next].

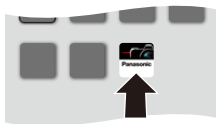

- If you have closed the message, select [?], then register the camera using [Camera registration (pairing)].
- A message is displayed if the Bluetooth function of the smartphone is turned off. (For Android devices) Allow turning on the Bluetooth function.

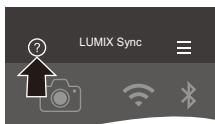

(For iOS devices) Follow the message to turn on the Bluetooth function in the settings screen of the smartphone and then display “LUMIX Sync”.

2 Check the content in the displayed guide and select [Next] until the screen to register the camera is displayed.

Operating the camera in accordance with the smartphone guide.

3 Set the camera to Bluetooth pairing standby status.

- [MENU/SET] → [] → [] → [Bluetooth] → [Bluetooth] → [SET] → [Pairing]
- The camera enters connection standby status, and the device name (A) is displayed.

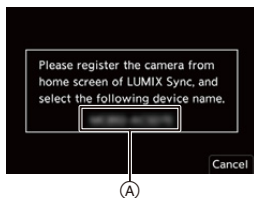

4 On the smartphone, select the camera device name.

- (iOS devices) When a message to confirm the change of destination is displayed, select [Join].

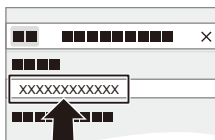

5 When a message indicating that device registration is complete, select [OK].

- A Bluetooth connection between the camera and the smartphone will be made.

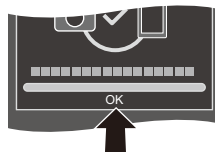



- The paired smartphone is registered as a paired device.
- During Bluetooth connection, [] is displayed in the recording screen. When the Bluetooth function is enabled, but a connection is not established with the smartphone, [] appears translucent.
- Up to 16 smartphones can be registered. If you try to register more than 16 smartphones, the registration information will be deleted from the oldest first.

- (iOS devices) If the Wi-Fi connection attempt fails during Bluetooth connection, follow the message displayed to allow connection to the camera. If you still cannot connect, select the SSID of the camera on the Wi-Fi setup screen of the smartphone to connect. If the SSID is not displayed, turn off and on the camera, then perform the Bluetooth connection settings again.

❖ End Bluetooth Connection





To terminate the Bluetooth connection, turn off the Bluetooth function of the camera.

 ⇒ [] ⇒ [] ⇒ [Bluetooth] ⇒ [Bluetooth] ⇒ Select [OFF]

- Even if you terminate the connection, the pairing information for it will not be deleted.

❖ Connecting to a Paired Smartphone

Connect paired smartphones using the following procedure.

- 1 Enable the Bluetooth function of the camera.
 -  ⇒ [] ⇒ [] ⇒ [Bluetooth] ⇒ [Bluetooth] ⇒ [ON]
- 2 On the smartphone, start up “LUMIX Sync”.
 - If a message is displayed indicating that the smartphone is searching for cameras, close the message.
- 3 Select [].
- 4 Select [Bluetooth Setup].
- 5 Turn Bluetooth ON.
- 6 From [Camera registered] items, select the camera’s device name.

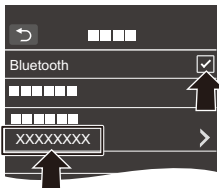
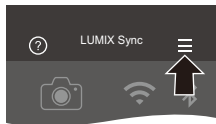



- Even if you set up pairing with more than one smartphone, you can only connect to one smartphone at a time.
- When pairing takes some time, canceling the pairing settings on both the smartphone and camera and re-establishing the connection may result in the camera being detected correctly.

❖ Canceling Pairing

- 1 Cancel the pairing setting of the camera.
 - ⇒ [] ⇒ [] ⇒ [Bluetooth] ⇒ [Bluetooth] ⇒ [SET] ⇒ [Delete]
- 2 Select the smartphone for which to cancel the pairing.



- Also cancel the pairing setting on the smartphone.
- When [Reset] in the [Setup] ([Setting]) menu is used to reset the network settings, the information for registered devices is deleted.

Connecting to a Smartphone ([Wi-Fi connection])



Use Wi-Fi to connect the camera and a smartphone that does not support Bluetooth Low Energy.

With default settings, simple connection with smartphones is possible without entering a password.

You can also use password authentication for enhanced connection security.

- You can also connect via Wi-Fi to a smartphone that supports Bluetooth Low Energy by following the same steps.

1 Set the camera to Wi-Fi connection standby status.

-  → [] → [] → [Wi-Fi] → [Wi-Fi Function] → [New Connection] → [Remote Shooting & View]
- The SSID (A) of the camera is displayed on the screen.



- You can also perform the same operation by pressing the Fn button assigned with [Wi-Fi].

For information about the Fn button, refer to page 278.

2 In the setting menu of the smartphone, turn the Wi-Fi function ON.

3 Select the SSID displayed on the camera.

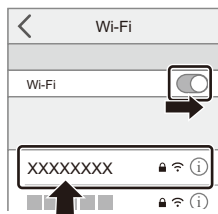

4 On the smartphone, start up "LUMIX Sync".



5 (At the first connection) Confirm the device name displayed on the camera and then select [Yes].





- When a device different than the one you want to connect to is displayed, the camera will automatically connect to that device if you select [Yes]. If there are other Wi-Fi connection devices nearby, we recommend using either manual password input or QR code to connect with password authentication. (→ 379)

❖ Using Password Authentication to Connect

You can enhance Wi-Fi connection security by using password authentication through either manual input or a QR code.

Scanning QR code to connect

1 Set [Wi-Fi Password] on the camera to [ON].

- ⇒ [] ⇒ [] ⇒ [Wi-Fi] ⇒ [Wi-Fi Setup] ⇒ [Wi-Fi Password] ⇒ [ON]

2 Display the QR code (A).

- ⇒ [] ⇒ [] ⇒ [Wi-Fi] ⇒ [Wi-Fi Function] ⇒ [New Connection] ⇒ [Remote Shooting & View]
- You can also perform the same operation by pressing the Fn button assigned with [Wi-Fi].

For information about the Fn button, refer to page 278.

- Press or to enlarge the QR code.

3 On the smartphone, start up “LUMIX Sync”.

- If a message is displayed indicating that the smartphone is searching for cameras, close the message.

4 Select [].

5 Select [Wi-Fi connection].

6 Select [QR code].

7 Scan the QR code displayed on the screen of the camera using “LUMIX Sync”.

- (iOS devices) When a message to confirm the change of destination is displayed, select [Join].

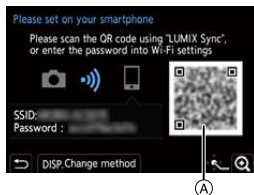



- (iOS devices) If the Wi-Fi connection fails, follow the message displayed to allow connection to the camera. If you still cannot connect, select the SSID of the camera on the Wi-Fi setup screen of the smartphone to connect. If the SSID is not displayed, turn off and on the camera, then perform the Wi-Fi connection settings again.

Manually entering a password to connect

- 1 Display the screen in Step 2 on page 379.
- 2 In the setting menu of the smartphone, turn the Wi-Fi function ON.

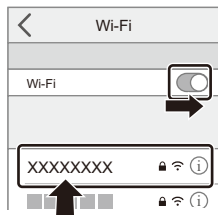

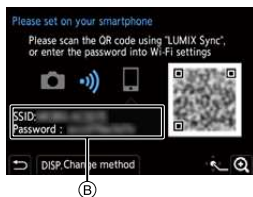

- 3 On the Wi-Fi setup screen, select the SSID (B) displayed on the camera.
- 4 (At the first connection)
Enter the password (B) displayed on the camera.
- 5 On the smartphone, start up "LUMIX Sync".





❖ Connection Methods Other Than the Default Settings



When connecting with [Via Network], or [WPS Connection] in [Direct], follow the steps below:

- 1 Display the connection method setting screen for the camera.
 -  ⇒ [] ⇒ [] ⇒ [Wi-Fi] ⇒ [Wi-Fi Function] ⇒ [New Connection] ⇒ [Remote Shooting & View]
- 2 Press [DISP.].

Connecting via network

- 1 Select [Via Network] and then press  or  .
 - Follow the connection method on page 412 to connect the camera to a wireless access point.
- 2 In the setting menu of the smartphone, turn the Wi-Fi function ON.
- 3 Connect the smartphone to the wireless access point that the camera is connected to.
- 4 On the smartphone, start up “LUMIX Sync”.

Connecting directly

- 1 Select [Direct] and then press  or  .
 - Select [WPS Connection], and follow the connection method on page 416 to connect the camera to a smartphone.
- 2 On the smartphone, start up “LUMIX Sync”.

Terminating the Wi-Fi Connection



To end the Wi-Fi connection between the camera and smartphone, follow the steps below:

1 Set the camera to recording mode.

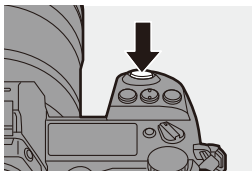
- Press the shutter button halfway.



2 End Wi-Fi connection.

-  ⇒ [] ⇒ [] ⇒ [Wi-Fi] ⇒ [Wi-Fi Function] ⇒ [Yes]
- You can also perform the same operation by pressing the Fn button assigned with [Wi-Fi].
For information about the Fn button, refer to page [278](#).

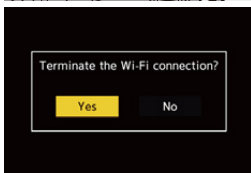

3 On the smartphone, close the “LUMIX Sync”.

Operating the Camera with a Smartphone

❖ Required Wireless Connectivity Type

Depending on the function used, the required type of wireless connection will differ.

Wireless connectivity required	Support for Bluetooth Low Energy
Bluetooth	Indicates that the function can be used with smartphones that support Bluetooth Low Energy.
Wi-Fi	Indicates that the function can be used with smartphones that do not support Bluetooth Low Energy.
Bluetooth Wi-Fi	Indicates that the function can be used with smartphones that support Bluetooth Low Energy. <ul style="list-style-type: none"> • Indicates that the function requires you to connect to a smartphone using both Bluetooth and Wi-Fi.

❖ Home Screen

When you start up “LUMIX Sync”, the home screen is displayed.

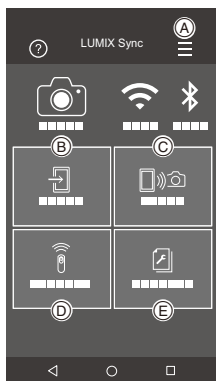

(A)	App settings (→ 376, 379, 393) This allows connection settings, camera power operations, and displays Help.
(B)	[Import images] (→ 388)
(C)	[Remote shooting] (→ 384)
(D)	[Shutter Remote Control] (→ 386)
(E)	[Camera settings copy] (→ 395)

[Remote shooting]

Wi-Fi

You can use the smartphone to record from a remote location while viewing the live view images from the camera.

Getting started:

- Connect the camera to a smartphone. (→ [374](#), [377](#))
- On the smartphone, start up “LUMIX Sync”.

1 Select [📷] ([Remote shooting]) in the home screen.

- (iOS devices) When a message to confirm the change of destination is displayed, select [Join].

2 Start recording.

(A)	Takes a picture
(B)	Starts/ends the video recording

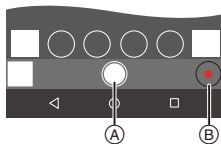

- The recorded image is saved on the camera.





- Certain features, including some settings, may not be available.
- Remote recording is not possible while you are using the following function:
 - [Time Lapse Shot]

❖ Operation Method During Remote Recording

Set either the camera or the smartphone as the priority control device to be used during remote recording.

 ⇒ [] ⇒ [] ⇒ [Wi-Fi] ⇒ [Wi-Fi Setup] ⇒ Select [Priority of Remote Device]

 [Camera]	<p>Operation is possible on both the camera and the smartphone.</p> <ul style="list-style-type: none"> • The camera's dial settings, etc. cannot be changed with the smartphone.
 [Smartphone]	<p>Operation is possible only on the smartphone.</p> <ul style="list-style-type: none"> • The camera's dial settings, etc. can be changed with the smartphone. • To end remote recording, press any of the buttons on the camera to turn on the screen, and select [End].

- The default setting is [Camera].



- The setting of this function cannot be changed while the connection is active.

[Shutter Remote Control]

Bluetooth



You can use the smartphone as a remote control for the shutter.

Getting started:

- Connect the camera to a smartphone by Bluetooth. (→ [374](#))
- On the smartphone, start up "LUMIX Sync".

1 Select [] ([Shutter Remote Control]) in the home screen.

2 Start recording.

	Starts/ends the video recording
	Takes a picture <ul style="list-style-type: none"> • Bulb recording (→ 387)







- To use the [Shutter Remote Control] to cancel [Sleep Mode] on the camera, set [Bluetooth] in the [Setup] ([IN/OUT]) menu as follows, then connect via Bluetooth:
 - [Remote Wakeup]: [ON]
 - [Auto Transfer]: [OFF]
- The camera cannot be turned on by using [Shutter Remote Control].

❖ Bulb Recording

The shutter can be kept open from the start to end of recording, which is useful for recording of starry skies or night scenery.

Getting started:

- Set the camera to [M] mode. (→ 185)
 - Set the camera shutter speed to [B] (Bulb). (→ 187)
- 1 Touch [] to start recording (keep touching, without removing your finger).
 - 2 Remove your finger from [] to end recording.
 - Slide [] in the direction of [LOCK] to record with the shutter button locked in a fully-pressed state.
(Slide [] back to its original position or press the camera shutter button to stop recording)
 - During [B] (Bulb) recording, if the Bluetooth connection is broken, then carry out Bluetooth connection again, then end recording from the smartphone.



❖ Shortening the Return Time from [Sleep Mode]

Select the smartphone function for which to shorten the time to wake the camera up from [Sleep Mode].

Getting started:

- Set [Bluetooth] and [Remote Wakeup] on the camera to [ON]. (→ 393)

 ⇒ [] ⇒ [] ⇒ [Bluetooth] ⇒ Select [Returning from Sleep Mode]

	[Remote / Transfer Priority]	Shortens the time to return when using [Remote shooting] or [Import images].
	[Remote Shutter Priority]	Shortens the time to return when using [Shutter Remote Control].

Transferring Recorded Images

Wi-Fi

Transfer an image stored on the card to the smartphone connected via Wi-Fi.

Getting started:

- Connect the camera to a smartphone. (→ [374](#), [377](#))
- On the smartphone, start up “LUMIX Sync”.

1 Select [] ([Import images]) in the “LUMIX Sync” home screen.



- (iOS devices) When a message to confirm the change of destination is displayed, select [Join].

2 Select the image to transfer.

- You can switch the card displayed by touching  (A).



3 Transfer the image.

- Select [].
- If the image is a video, you can play it back by touching [] at the center of the screen.





- You will need Android 7.0 or higher to save RAW pictures on an Android device.

Depending on the smartphone or the OS, these may not be displayed correctly.

- When a video is played back, this has a small data size and is transmitted using “LUMIX Sync”, therefore its image quality will differ from that of the actual video recording.

Depending on the smartphone and on the usage conditions, the image quality may deteriorate or the sound may skip during video or picture playback.

- Images recorded using the following functions cannot be transferred:
 - [AVCHD], [MP4] 4K videos
 - [6K/4K PHOTO]/[Post-Focus]
 - [HLG Photo] (HLG format pictures)

Transferring Recorded Images Automatically



Bluetooth Wi-Fi

You can automatically transfer recorded pictures to a smartphone as they are taken.

Getting started:

- Connect the camera to a smartphone by Bluetooth. (→ 374)

1 Enable [Auto Transfer] on the camera.

-  →  →  → [Bluetooth] → [Auto Transfer] → [ON]
- If a confirmation screen is displayed on the camera asking you to terminate the Wi-Fi connection, select [Yes] to terminate it.



2 On the smartphone, select [Yes].

- (iOS devices) When a message to confirm the change of destination is displayed, select [Join].
- The camera automatically makes a Wi-Fi connection.

3 Check the send settings on the camera and then press or .

- To change the send setting, press [DISP.]. (→ 419)
- The camera will enter a mode where it can automatically transfer images and  will be displayed on the recording screen.



(If the settings are not displayed, then automatic image transfer is not possible. Check the status of the Wi-Fi connection to the smartphone.)

4 Record with the camera.

- This automatically sends the recorded pictures to the specified device as they are taken.
- [📷➔] is displayed in the recording screen of the camera while a file is being sent.

❖ To Stop the Automatic Transfer of Images

 ➔ [🔧] ➔ [📶] ➔ [Bluetooth] ➔ [Auto Transfer] ➔ Select [OFF]

- A confirmation screen is displayed, asking you to terminate the Wi-Fi connection.



- If the [Bluetooth] and [Auto Transfer] settings of the camera are [ON], the camera automatically connects to the smartphone via Bluetooth and Wi-Fi when you turn on the camera.
Start up the “LUMIX Sync” to connect to the camera.
The camera will enter a mode where it can automatically transfer images and [📶] is displayed in the recording screen of the camera.



- When [Auto Transfer] is set to [ON], [Wi-Fi Function] cannot be used.
- If the camera is turned off during image transfer, and the file sending is interrupted, then turn on the camera to restart the sending.
 - If the storage status of unsent files changes, then sending of files may no longer be possible.
 - If there are many unsent files, then sending of all files may not be possible.
- Saving RAW format images on Android devices requires Android 7.0 or higher.
Depending on the smartphone or the OS, these may not be displayed correctly.
- Images recorded with the following functions cannot be transferred automatically:
 - Video recording/[6K/4K PHOTO]/[Post-Focus]
 - [HLG Photo] (HLG format pictures)

Recording Location Information

Bluetooth

The smartphone sends its location information to the camera via Bluetooth, and the camera performs recording while writing the acquired location information.

Getting started:

- Enable the GPS function on the smartphone.
- Connect the camera to a smartphone by Bluetooth. (→ 374)

1 Enable [Location Logging] on the camera.

-  ⇒  ⇒  ⇒ [Bluetooth] ⇒ [Location Logging] ⇒ [ON]

- The camera will enter a mode where location information can be recorded and [GPS] is displayed in the recording screen of the camera.

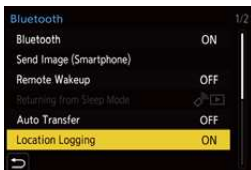

2 Record images with the camera.

- Location information will be written to the recorded images.



-  When [GPS] on the recording screen appears translucent, location information cannot be acquired, therefore data cannot be written. Smartphone GPS positioning may not be possible if the smartphone is within a building, a bag, or similar. Move the smartphone to a position affording a wide view of the sky to improve positioning performance. In addition, refer to the operating instructions of your smartphone.
- Images with location information are indicated with [GPS].
- Be sure to pay special attention to the privacy, the likeness rights, etc. of the subject when you use this function. Use at your own risk.
- The smartphone drains its battery faster while acquiring location information.
- Location information is not written to AVCHD videos.

Camera Power Operations

Bluetooth Wi-Fi

Even when the camera is turned off, the smartphone can be used to start the camera and record images, or check the recorded images.

Getting started:

- ❶ Connect to a smartphone using Bluetooth. (→ 374)
- ❷ Enable [Remote Wakeup] on the camera.
 -  ⇒ [] ⇒ [] ⇒ [Bluetooth] ⇒ [Remote Wakeup] ⇒ [ON]
- ❸ Set the camera on/off switch to [OFF].
- ❹ On the smartphone, start up “LUMIX Sync”.

❖ Turning On the Camera

Select [Remote shooting] in the “LUMIX Sync” home screen.

- (iOS devices) When a message to confirm the change of destination is displayed, select [Join].
- The camera turns on, and automatically connects using Wi-Fi.

❖ Turning Off the Camera

- ❶ Select [] in the “LUMIX Sync” home screen.
- ❷ Select [Turn off the camera].
- ❸ Select [Power OFF].



- When [Remote Wakeup] has been set, the Bluetooth function continues to work even if the camera on/off switch is set to [OFF], so the battery will drain.

Automatically Setting the Clock

Bluetooth

Synchronize the clock and the time zone setting of the camera with those of a smartphone.

Getting started:

- Connect the camera to a smartphone by Bluetooth. (→ 374)

Enabling [Auto Clock Set] on the camera.

-  → [] → [] → [Bluetooth] → [Auto Clock Set] → [ON]



Saving Settings Information

Bluetooth Wi-Fi

This saves the camera's settings information to the smartphone. Saved settings information can be loaded to the camera, letting you set the same settings on multiple cameras.

Getting started:

- Connect the camera to a smartphone by Bluetooth. (→ 374)

1 Select [] ([Camera settings copy]) in the “LUMIX Sync” home screen.

2 Save or load setup information.

- Read the [Help] in the “LUMIX Sync” menu for further details on how to operate the “LUMIX Sync”.





- Only settings information from the same model can be loaded.
- When transferring settings information, a Wi-Fi connection is automatically created.
(iOS devices) When a message to confirm the change of destination is displayed, select [Join].
- You can save or load the settings information of items that are the same as those in [Save/Restore Camera Setting] under the [Setup] ([Setting]) menu.

Sending Images from the Camera

Operate the camera to send recorded images to a device connected by Wi-Fi.

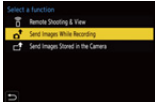
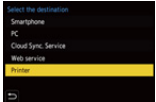
Operation flow

1	Select the sending method.	
2	Select the destination (type of the destination device).	
3	Select the connection method and then connect by Wi-Fi.	
4	Check the send settings.	
5	Take pictures.	Select one or more images.
	<p>This automatically sends the recorded pictures as they are taken.</p>	<p>Send the selected images.</p> <ul style="list-style-type: none"> – Selecting images (→ 420)

Detailed information about connection methods for each destination device is described on pages 399 to 411.

Refer to the following pages for the steps common to all devices.

- Wi-Fi connections: [Via Network] (→ 412)/[Direct] (→ 416)
- Image send settings (→ 419)
- Selecting images (→ 420)

❖ Images That Can be Sent

Images that can be sent differ depending on the destination device.

Destination device	Images that can be sent	
	[Send Images While Recording]	[Send Images Stored in the Camera]
[Smartphone] (→ 399)	JPEG/RAW	JPEG/RAW/MP4
[PC] (→ 402)	JPEG/RAW	JPEG/RAW/MP4/AVCHD/ 6K/4K burst files/ Post-Focus images
[Cloud Sync. Service] (→ 410)	JPEG	JPEG/MP4
[Web service] (→ 407)	JPEG	JPEG/MP4
[Printer] (→ 405)	—	JPEG

- You will need Android 7.0 or higher to send RAW images to a [Smartphone] when using an Android device.
- AVCHD videos with a file size exceeding 4 GB cannot be sent to a [PC].
- 4K videos cannot be sent to [Smartphone], [Cloud Sync. Service], and [Web service].
- It is not possible to send HLG format pictures recorded with [HLG Photo]. However, the RAW/JPEG images recorded at the same time will be sent to [Smartphone], [PC], [Cloud Sync. Service] or [Web service].



- Sending may not be possible depending on your device.
- It may not be possible to send images recorded with devices other than this camera, or images edited or processed on a PC.

❖ Fn Button Assigned with [Wi-Fi]

You can perform the following operations by pressing the Fn button assigned with [Wi-Fi] after connecting to Wi-Fi.

For information on Fn buttons, refer to page [278](#).



[Terminate the Connection]	Terminates the Wi-Fi connection.
[Change the Destination]	Terminates the Wi-Fi connection, and allows you to select a different Wi-Fi connection.
[Change Settings for Sending Images]	Sets the image size, file format, and other items for sending recorded images. (→ 419)
[Register the Current Destination to Favorite]	Registers the current connection destination or method so that you can easily connect with the same connection settings next time.
[Network Address]	Displays the MAC address and IP address of the camera. (→ 422)

- Depending on the Wi-Fi function being used or the connection destination, you may not be able to perform some of these operations.



[Smartphone]

Transfer recorded images to a smartphone connected using Wi-Fi.

Getting started:

- Install “LUMIX Sync” on your smartphone. (→ 373)

1 Select the method for sending the images on the camera.

-  →  →  → [Wi-Fi] → [Wi-Fi Function] → [New Connection] → [Send Images While Recording] or [Send Images Stored in the Camera]



2 Set the destination to [Smartphone].

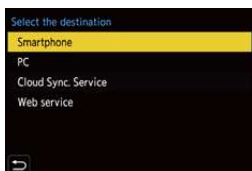

3 Connect the camera to a smartphone by Wi-Fi.

- Select [Via Network] (→ 412) or [Direct] (→ 416), and then connect.

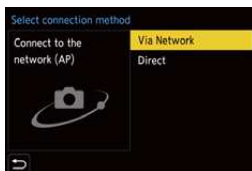

4 On the smartphone, start up “LUMIX Sync”.

5 Select the destination smartphone on the camera.



6 Check the send settings and then press or .

- To change the send settings of images, press [DISP.]. (→ 419)

7 When [Send Images While Recording] is selected:

Take pictures.

- This automatically sends the recorded pictures to the specified device as they are taken.
- [] is displayed in the recording screen of the camera while a file is being sent.
- To end the connection, follow the steps below:

[] ⇒ [] ⇒ [] ⇒ [Wi-Fi] ⇒ [Wi-Fi Function] ⇒ [Yes]

When [Send Images Stored in the Camera] is selected:

Select one or more images.

- Select [Single Select] or [Multi Select], and then select one or more images. (→ 420)
- To end the connection, select [Exit].



- When recording, recording is prioritized so it will take time for sending to complete.
- If the camera is turned off, or the Wi-Fi is disconnected before sending is completed, then sending will not restart.
- You may not be able to delete files or use the [Playback] menu while sending.
- When [Auto Transfer] in [Bluetooth] is set to [ON], [Wi-Fi Function] is not available.

❖ Sending Images on the Camera to a Smartphone with Simple Operations

You can transfer pictures to a smartphone connected by Bluetooth just by pressing the Fn button during playback.

You can also use the menu to connect easily.

- Use the Fn button registered with [Send Image (Smartphone)] to operate. In default settings, this is registered in [Q].

For information about the Fn button, refer to page 278.

Getting started:

- Install “LUMIX Sync” on your smartphone. (→ 373)
- Connect the camera to a smartphone by Bluetooth. (→ 374)
- Press [▶] on the camera to display the playback screen.



Send a single image

- 1 Press ◀▶ to select the image.
- 2 Press [Q].
- 3 Select [Single Select].
 - To change the send settings of images, press [DISP.]. (→ 419)
- 4 On the smartphone, select [Yes].
 - This connects automatically using Wi-Fi.

Send multiple images

- 1 Press [Q].
- 2 Select [Multi Select].
 - To change the send settings of images, press [DISP.]. (→ 419)
- 3 Select the images and then transfer.

◀▶ : Select images



 or  : Set/Cancel



[DISP.] : Transfer
- 4 On the smartphone, select [Yes].
 - This connects automatically using Wi-Fi.



- (iOS devices) When a message to confirm the change of destination is displayed, select [Join].
- This function is not available when [Auto Transfer] in [Bluetooth] is set to [ON].

Using the menu to transfer easily.

 ⇒ [] ⇒ [] ⇒ [Bluetooth] ⇒ [Send Image (Smartphone)]
Settings: [Single Select]/[Multi Select]

- If [Single Select], press ◀▶ to select the image and then press  or  to execute.
- If [Multi Select], use the same operation as with the Fn button to execute.

[PC]

Send recorded images to the PC connected with Wi-Fi.



Supported OS

Windows: Windows 10/Windows 8.1/Windows 8/Windows 7

Mac: OS X v10.5 to v10.11, macOS 10.12 to macOS 10.14

Getting started:

- Turn on the PC.
- Create a destination folder for images.
- If the workgroup of the destination PC has been changed from the standard setting, change the corresponding setting of the camera in [PC Connection]. (→ [421](#))

❖ Create a Destination Folder for Images

When using Windows (Example for Windows 7)

- 1 Select the destination folder and then right-click.
- 2 Select [Properties] and then enable folder sharing.

- You can also use “PHOTOfunSTUDIO” to create folders.
For details, refer to the operating instructions for “PHOTOfunSTUDIO”.



When using Mac (Example for OS X v10.8)

- 1 Select the destination folder and then click the items in the following order.
[File] ⇒ [Get Info]
- 2 Enable folder sharing.



- Create a PC account name (up to 254 characters) and password (up to 32 characters) consisting of alphanumeric characters. A destination folder may not be created if the account name includes non-alphanumeric characters.
- When the computer name (NetBIOS name for Mac) contains a space (blank character), etc., it may not be recognized. In that case, we recommend changing the name to one consisting only of 15 or less alphanumeric characters.
- For details, refer to the operating instructions for your PC or Help on the OS.

1 Select the method for sending images on the camera.

-  ⇒ [] ⇒ [] ⇒ [Wi-Fi] ⇒ [Wi-Fi Function] ⇒ [New Connection] ⇒ [Send Images While Recording] or [Send Images Stored in the Camera]



2 Set the destination to [PC].



3 Connect the camera and smartphone by Wi-Fi.

- Select [Via Network] (→ 412) or [Direct] (→ 416), and then connect.

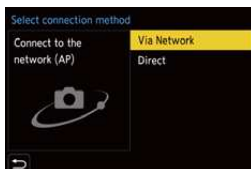

4 Enter the computer name of the PC name you want to connect to (for Mac, the NetBIOS name).

- For information on how to enter characters, refer to page 369.



5 Select a folder for storing images.

- Folders sorted by sent date will be created in the selected folder, and images will be saved there.

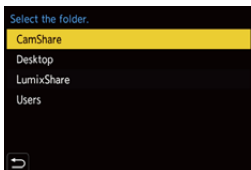





6 Check the send settings and then press or .

- To change the send setting, press [DISP.]. (→ 419)

7 When [Send Images While Recording] is selected:

Take pictures.

- This automatically sends the recorded pictures to the specified device as they are taken.
-  is displayed in the recording screen of the camera while a file is being sent.
- To end the connection, follow the steps below:

 ⇒  ⇒  ⇒ [Wi-Fi] ⇒ [Wi-Fi Function] ⇒ [Yes]

When [Send Images Stored in the Camera] is selected:

Select one or more images.

- Select [Single Select] or [Multi Select], and then select one or more images. (→ 420)
- To end the connection, select [Exit].





- If the screen for a user account and password entry appears, enter the one you set on your PC.
- When the firewall of the OS, security software, etc. is enabled, connecting to the PC may not be possible.
- During recording, these have priority, so it will take time until sending is complete.
- If the camera is turned off, or the Wi-Fi is disconnected before sending is completed, then sending will not restart.
- You may not be able to delete files or use the [Playback] menu while sending.
- When [Auto Transfer] in [Bluetooth] is set to [ON], [Wi-Fi Function] is not available.

[Printer]

You can send images to a PictBridge (wireless LAN)*-supported printer connected by Wi-Fi for printing.

* DPS over IP standard-compliant

1 Select the method for sending images on the camera.

-  ⇒  ⇒  ⇒ [Wi-Fi] ⇒ [Wi-Fi Function] ⇒ [New Connection] ⇒ [Send Images Stored in the Camera]

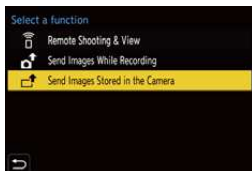

2 Set the destination to [Printer].



3 Connect the camera to a printer by Wi-Fi.

- Select [Via Network] (→ 412) or [Direct] (→ 416), and then connect.

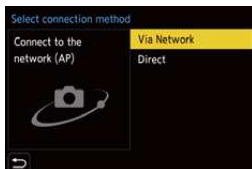

4 Select the destination printer.

5 Select and print images.

- The procedure for selecting images is the same as the one for when the USB connection cable is connected. (→ 442)
- To terminate the connection, press [↵].
- You can also end the connection by pressing the Fn button assigned with [Wi-Fi].
For information about the Fn button, refer to page 278.



- For details about PictBridge (wireless LAN-compatible) printers, contact their manufacturers.
- When [Auto Transfer] in [Bluetooth] is set to [ON], [Wi-Fi Function] is not available.



[Web service]

You can use “LUMIX CLUB” to upload recorded images to web services such as social networking sites.

Getting started:

- Register with “LUMIX CLUB”. (→ 422)
- Before sending images to a service, register that web service. (→ 424)

1 Select the method for sending images on the camera.

-  ⇒ [] ⇒ [] ⇒ [Wi-Fi] ⇒ [Wi-Fi Function] ⇒ [New Connection] ⇒ [Send Images While Recording] or [Send Images Stored in the Camera]

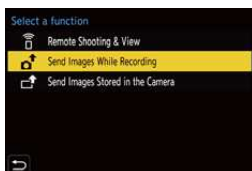

2 Set the destination to [Web service].

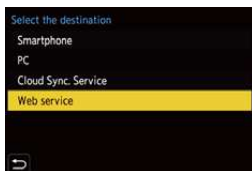

3 Connect to the web service.

- Select [Via Network] and then connect. (→ 412)

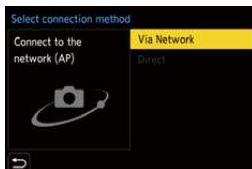

4 Select the web service.



5 Check the send settings and then press or .

- To change the send settings of images, press [DISP.]. (→ 419)

6 When [Send Images While Recording] is selected:

Take pictures.

- This automatically sends the recorded pictures to the specified service as they are taken.
-  is displayed while a file is being sent.
- To end the connection, follow the steps below:

 ⇒ [] ⇒ [] ⇒ [Wi-Fi] ⇒ [Wi-Fi Function] ⇒ [Yes]

When [Send Images Stored in the Camera] is selected:

Select one or more images.

- Select [Single Select] or [Multi Select], and then select one or more images. (→ 420)
- To end the connection, select [Exit].



- During recording, these have priority, so it will take time until sending is complete.
- If the camera is turned off, or the Wi-Fi is disconnected before sending is completed, then sending will not restart.
- You may not be able to delete files or use the [Playback] menu while sending.
- If image sending fails, a report email outlining the failure will be sent to the email address registered in the “LUMIX CLUB”.
- Panasonic assumes no responsibility for any damages resulting from the leakage, loss, etc. of images uploaded on web services.
- When uploading images to a web service, do not delete images from the camera, even after they have finished sending, until you have checked that they have been properly uploaded to the web service.
Panasonic assumes no responsibility for any damages resulting from the deletion of images stored on the camera.
- Images uploaded to web services cannot be displayed or deleted with the camera.
- Images may contain information that can be used to identify the user, such as recording dates and times, and location information. Check carefully when uploading the images to a web service.
- When [Auto Transfer] in [Bluetooth] is set to [ON], [Wi-Fi Function] is not available.



[Cloud Sync. Service]

This camera can automatically transfer recorded images to a cloud sync service via “LUMIX CLUB” to send them to a PC or smartphone.

To use [Cloud Sync. Service] (As of January 2019)

- You need to register to the “LUMIX CLUB” (→ 422) and set up cloud synchronization to send images to a cloud folder.
To set up cloud synchronization, use “PHOTOfunSTUDIO”.
- Sent images are temporarily saved in the cloud folder. These can be synchronized with your PC, smartphone, and other devices.
- A cloud folder stores sent images for 30 days (up to 1000 images).
Please note that the images will be deleted automatically in the following cases:
 - If 30 days have passed after sending (even if within 30 days of the transfer, if images have been downloaded to all specified devices, then these may be deleted)
 - If there are in excess of 1000 images (depending on the [Cloud Limit] (→ 419) setting)

1 Select the method for sending images on the camera.

-  ⇒ [] ⇒ [] ⇒ [Wi-Fi] ⇒ [Wi-Fi Function] ⇒ [New Connection] ⇒ [Send Images While Recording] or [Send Images Stored in the Camera]



2 Set the destination to [Cloud Sync. Service].



3 Connect to the cloud sync service.

- Select [Via Network] and then connect. (→ 412)

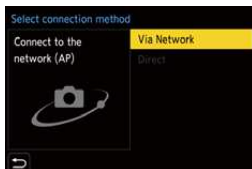

4 Check the send settings and then press or .

- To change the send settings of images, press [DISP.]. (→ 419)

5 When [Send Images While Recording] is selected:

Take pictures.

- This automatically sends the recorded pictures to the cloud sync services as they are taken.
- [] is displayed while a file is being sent.
- To end the connection, follow the steps below:

 → [] → [] → [Wi-Fi] → [Wi-Fi Function] → [Yes]

When [Send Images Stored in the Camera] is selected:

Select one or more images.

- Select [Single Select] or [Multi Select], and then select one or more images. (→ 420)
- To end the connection, select [Exit].

-  During recording, these have priority, so it will take time until sending is complete.
- If the camera is turned off, or the Wi-Fi is disconnected before sending is completed, then sending will not restart.
- You may not be able to delete files or use the [Playback] menu while sending.
- When [Auto Transfer] in [Bluetooth] is set to [ON], [Wi-Fi Function] is not available.

Wi-Fi Connections

When [New Connection] has been selected in [Wi-Fi Function] in [Wi-Fi] of the [Setup] ([IN/OUT]) menu, select the connection method from either [Via Network] or [Direct] to connect.

On the other hand, when you use [Select a destination from History] or [Select a destination from Favorite], the camera connects to the selected device with the previously-used settings.



[Via Network]

Connect the camera and destination device through the wireless access point.

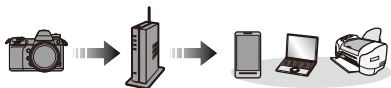

Select the method for connecting to a wireless access point.



[WPS (Push-Button)] (→ 413)	Press the WPS button on the wireless access point to set up a connection.
[WPS (PIN code)] (→ 414)	Enter a PIN code into the wireless access point to set up a connection.
[From List] (→ 414)	Searches for a wireless access point to use, and connects to this.



- After selecting [Via Network] once, the camera will connect to the previously-used wireless access point.
To change the wireless access point used for connection, press [DISP.] and change the connection destination.

❖ [WPS (Push-Button)]

Press the WPS button on the wireless access point to set up a connection.

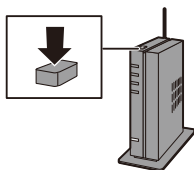

Press the wireless access point WPS button until it switches to WPS mode.

Example)



❖ [WPS (PIN code)]

Enter a PIN code into the wireless access point to set up a connection.

- ❶ On the camera screen, select the wireless access point you are connecting to.
- ❷ Enter the PIN code displayed on the camera screen into the wireless access point.
- ❸ Press  or  of the camera.



• WPS is a function that allows you to easily configure the settings related to the connection and security of wireless LAN devices.

For details about the operation and compatibility of WPS, refer to the operating instructions for the wireless access point.

❖ [From List]

Searches for a wireless access point to use, and connects to this.



• Confirm the encryption key of the wireless access point.

- ❶ Select the wireless access point you are connecting to.
 - Press [DISP.] to run a wireless access point search again.
 - If no wireless access point is found, refer to “Connecting by Manual Input” on page 415.
- ❷ (If network authentication is encrypted) Enter the encryption key.
 - For information on how to enter characters, refer to page 369.



❖ Connecting by Manual Input



- Check the SSID, security type, encryption type, and encryption key of the wireless access point you are using.

- 1 In the screen in Step 1 of “[From List]”, select [Manual Input]. (→ 414)
- 2 Enter the SSID of the wireless access point you are connecting to, and then select [Set].
 - For information on how to enter characters, refer to page 369.
- 3 Select the network authentication type.

[WPA2-PSK]	Supported encryption methods: [TKIP], [AES]
[WPA2/WPA-PSK]	
[No Encryption]	—

- 4 (When other than [No Encryption] is selected)
Enter the encryption key and then select [Set].



- Check the operating instructions and settings of the wireless access point.
- If a connection cannot be made, the signal strength of the wireless access point may be too weak.
For details, refer to “Message Displays” (→ 456) and “Troubleshooting” (→ 459).
- Depending on your environment, the communication speed with the wireless access point may decrease, or the wireless access point may not be available for use.

[Direct]

Directly connect the camera and the destination device.



Select the method for connecting with the destination device.



[WPS Connection]	[WPS (Push-Button)]	<p>Press the WPS button on the destination device to connect.</p> <ul style="list-style-type: none"> On the camera, press [DISP.] to extend the connection wait time.
	[WPS (PIN code)]	<p>Enter the PIN code into the camera, and connect.</p>
[Manual Connection]	<p>Search for the camera on the destination device to connect. Enter the SSID and password displayed on the camera into the device.</p> <ul style="list-style-type: none"> If the destination is set to [Smartphone], the password is not displayed. Select the SSID to establish a connection. (→ 377) 	



- Please also refer to the operating instructions for the device to be connected.

Connect to Wi-Fi Using Previously Saved Settings

Use the Wi-Fi connection history to connect using the same settings as previously.

1 Display the Wi-Fi connection history.

- **MENU/SET** ⇒ [**Wrench**] ⇒ [**Wi-Fi**] ⇒ [Wi-Fi] ⇒ [Wi-Fi Function] ⇒ [Select a destination from History] or [Select a destination from Favorite]



2 Select the History item to connect to.

- Press [DISP.] to confirm details of the connection history.

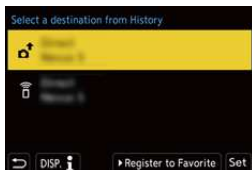

- If the settings of the device to connect to have been changed, it may not be possible to connect to the device.

❖ Register to Favorite

You can register the Wi-Fi connection history to Favorite.

1 Display the Wi-Fi connection history.

- **MENU/SET** ⇒ [**Wrench**] ⇒ [**Wi-Fi**] ⇒ [Wi-Fi] ⇒ [Wi-Fi Function] ⇒ [Select a destination from History]



2 Select the History item to register and then press ►.

3 Enter a registration name and then press [Set].

- For information on how to enter characters, refer to page 369.
- A maximum of 30 characters can be entered. A two-byte character is treated as two characters.

❖ Editing Items Registered in Favorite

1 Display items registered to Favorite.

-  ⇒ [] ⇒ [] ⇒ [Wi-Fi] ⇒ [Wi-Fi Function] ⇒ [Select a destination from Favorite]

2 Select the History item to edit in Favorite and then press ►.

[Remove from Favorite]	—
[Change the Order in Favorite]	Specify the destination location of the desired item to change the display order.
[Change the Registered Name]	Enter characters to change the registered name. <ul style="list-style-type: none"> • For information on how to enter characters, refer to page 369.

-  The number of items that can be saved in History is limited. Register frequently-used connection settings to Favorite.
- When [Reset] in the [Setup] ([Setting]) menu is used to reset the network settings, the content registered in History and Favorite is deleted.
- If the device you want to connect to (smartphone, etc.) is connected to a wireless access point other than the camera, you cannot connect the device to the camera using [Direct].
Change the Wi-Fi settings of the device you want to connect to so that the access point to be used is set to the camera. You can also select [New Connection] and reconnect the devices. (→ [377](#))
- It may be difficult to connect to networks to which many devices are connected. In these cases, connect using [New Connection].

Send Settings and Selecting Images

Image Send Settings

Set the size, file format, and other items for sending the image to the destination device.

- 1 After Wi-Fi connection, the send settings confirmation screen will be displayed, so press [DISP.].
- 2 Change the send settings.





[Size]	Resize the image to send. [Original]/[Auto]/[Change] ([M], [S], or [VGA]) <ul style="list-style-type: none"> The [Auto] image size changes depending on the status of the destination device. (This can be set when the destination is [Web service])
[File Format]	Sets the file format of images to send. [JPG]/[RAW+JPG]/[RAW] <ul style="list-style-type: none"> This can be set when the destination is [Smartphone] or [PC].
[Delete Location Data]	Select whether to delete the location information from images before sending them. <ul style="list-style-type: none"> This can be set when the destination is [Cloud Sync. Service] or [Web service]. This operation only deletes the location information from the images that are set to be sent.
[Cloud Limit]	You can select whether to send images when the cloud folder runs out of free space. [ON]: Does not send images. [OFF]: Deletes images from the oldest ones, then sends new images. <ul style="list-style-type: none"> This can be set when the destination is [Cloud Sync. Service].

Selecting Images

When sending by [Send Images Stored in the Camera], select the images using the following procedure.





- 1 Select [Single Select] or [Multi Select].
- 2 Select the image.

[Single Select] setting

- 1 Press ◀▶ to select an image.
- 2 Press  or .



[Multi Select] setting

- 1 Press ▲▼◀▶ to select an image and then press  or . (Repeat this)
 - To cancel the setting, press  or  again.
 - Images are displayed separately by card slot.
 - To switch the card to display, press [].
 - Selecting images at once is possible only for the images in a single card.
- 2 Press [DISP.] to execute.





[Wi-Fi Setup] Menu

This configures the settings required for the Wi-Fi function.
The settings cannot be changed when connected to Wi-Fi.

Displaying the [Wi-Fi Setup] menu.

●  ⇒ [] ⇒ [] ⇒ [Wi-Fi] ⇒ [Wi-Fi Setup]

[Priority of Remote Device]	This sets either the camera or the smartphone as the priority control device to be used during remote recording. (→ 385)
[Wi-Fi Password]	You can use a password to connect for enhanced security. (→ 379)
[LUMIX CLUB]	This acquires or changes the “LUMIX CLUB” login ID. (→ 423)
[PC Connection]	<p>You can set the workgroup. To send images to a PC, you need to connect to the same workgroup as the destination PC. (The default setting is “WORKGROUP”.)</p> <ul style="list-style-type: none"> • To change the workgroup name, press  or  and enter the new workgroup name. For information on how to enter characters, refer to page 369. • To return to the default settings, press [DISP.].
[Device Name]	<p>You can change the name (SSID) of the camera.</p> <ul style="list-style-type: none"> • To change the SSID, press [DISP.] and enter the new SSID name. For information on how to enter characters, refer to page 369. • A maximum of 32 characters can be entered.

[Wi-Fi Function Lock]	<p>To prevent incorrect operation and use of the Wi-Fi function by a third party and to protect personal information in the camera and included with images, protect the Wi-Fi function with a password.</p> <p>[Setup]: Enter any 4-digit numbers as the password.</p> <ul style="list-style-type: none"> • For information on how to enter characters, refer to page 369. <p>[Cancel]: Cancel the password.</p> <ul style="list-style-type: none"> • Once a password is set, you are required to enter it each time you use the Wi-Fi function. • If you forget your password, you can use [Reset] in the [Setup] ([Setting]) menu to reset the network settings and thereby reset the password.
[Network Address]	Displays the MAC address and IP address of the camera.

“LUMIX CLUB”

Refer to the “LUMIX CLUB” site for details.

<https://lumixclub.panasonic.net/eng/c/>





- The service may be suspended due to regular maintenance or unexpected troubles, and the service contents may be changed or added, without prior notice to the users.

The service may also be stopped in whole or in part with a reasonable period of advance notice.

❖ Obtain a New Login ID from the Camera

From the camera menu, acquire a “LUMIX CLUB” login ID.

1 Follow the menu path.



-  ⇒ [] ⇒ [] ⇒ [Wi-Fi] ⇒ [Wi-Fi Setup] ⇒ [LUMIX CLUB] ⇒ [Set/Add Account] ⇒ [New account]
- Connect to the network.
Proceed to the next page by selecting [Next].



2 Select and set the method for connecting to a wireless access point, and set. (→ 412)

- Except for the first-time connection, the camera will connect to the previously-used wireless access point.
To change the connection destination, press [DISP.].
- Proceed to the next page by selecting [Next].

3 Read through the “LUMIX CLUB” terms of use and then select [Agree].

- Switch pages: ▲▼
- Zoom: Rotate  to the right (to restore: rotate  to the left)
- Move the enlarged area: ▲▼◀▶
- Cancel without registering: [] button

4 Enter a password.

- Enter any combination of 8 to 16 characters and numbers for the password.
- For information on how to enter characters, refer to page 369.

5 Check the login ID and then select [OK].

- Be sure to make a note of the login ID and password.
- The login ID (12-digit number) will be displayed automatically.



❖ Register a Web Service with “LUMIX CLUB”



- Confirm web services supported by “LUMIX CLUB” in “FAQ/Contact us” at the website below.
https://lumixclub.panasonic.net/eng/c/lumix_faqs/



Getting started:

- Make sure that you have created an account on the web service you want to use, and have the login information available.

- 1 Connect to the “LUMIX CLUB” site using a smartphone or PC.

<https://lumixclub.panasonic.net/eng/c/>



- 2 Enter your “LUMIX CLUB” login ID and password to log in.

- If you have not registered your email address to the “LUMIX CLUB” yet, please register it.

- 3 Select and register the web service you want to use for web service link settings.

- Follow the on-screen instructions to perform the registration.

❖ Confirm/Change Login ID or Password

Getting started:

- When using the acquired login ID, check the ID and password.
- Access the “LUMIX CLUB” website from your PC to change the password.

- 1 Follow the menu path.

- ⇒ [] ⇒ [] ⇒ [Wi-Fi] ⇒ [Wi-Fi Setup] ⇒ [LUMIX CLUB] ⇒ [Set/Add Account] ⇒ [Set Login ID]
- The login ID and password are displayed.
- The password is displayed as “*”.

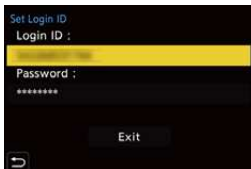

- 2 Select the item to change.



- 3 Enter the login ID or password.
 - For information on how to enter characters, refer to page 369.
- 4 Select [Exit].

❖ Checking the “LUMIX CLUB” Terms of Use

Check the details if the terms of use have been updated, for example.

 ⇒ [] ⇒ [] ⇒ [Wi-Fi] ⇒ [Wi-Fi Setup] ⇒ [LUMIX CLUB] ⇒ Select [Terms of use]



❖ Deleting Your Login ID and Closing Your “LUMIX CLUB” Account

Delete the login ID from the camera when transferring it to another party or disposing of it.

You can also close your “LUMIX CLUB” account.



- You can only change or delete the login ID acquired with the camera.

- 1 Follow the menu path.
 -  ⇒ [] ⇒ [] ⇒ [Wi-Fi] ⇒ [Wi-Fi Setup] ⇒ [LUMIX CLUB] ⇒ [Delete account]
 - A message is displayed. Select [Next].
- 2 Select [Yes] on the login ID delete confirmation screen.
 - A message is displayed. Select [Next].
- 3 Select [Yes] on the confirmation screen asking whether to close the “LUMIX CLUB” account.
 - A message is displayed. Select [Next].
 - To continue without closing the account, select [No] to delete only the login ID.
- 4 Select [OK].

16. Connecting to Other Devices

Viewing on a TV

You can connect the camera to a TV to view recorded pictures and videos on the TV.

Getting started:

- Turn off the camera and TV.

1 Connect the camera and TV with a commercially available HDMI cable.

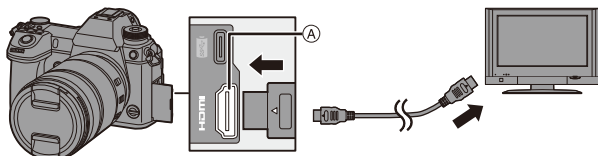

Ⓐ [HDMI] socket (Type A)

- Check the direction of the terminals and plug in/out straight holding onto the plug.
(Inserting these at an angle may cause deformation or malfunction)
- Do not connect the cable to the wrong terminals. This may cause a malfunction.

2 Turn on the TV.

3 Switch the input of the TV.

- Switch the input of the TV to match the terminal to which you connected the HDMI cable.

4 Turn on the camera.

5 Display the playback screen.

- Press [▶].
- The recorded images are displayed on the TV. (The monitor and viewfinder of the camera will turn off.)

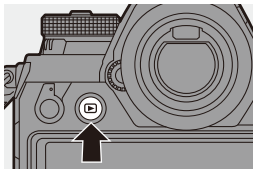

- With the default settings, pictures are output at the optimal resolution for the connected TV.

The output resolution can be changed in [HDMI Mode (Playback)]. (→ 357)

- Depending on the aspect ratio, gray bands may be displayed on the top and bottom or the left and right of images.

You can change the band color in [Background Color(Playback)] in [TV Connection] of the [Setup] ([IN/OUT]) menu. (→ 358)



- Use a “High Speed HDMI cable” with the HDMI logo.
Cables that do not comply with the HDMI standards will not work.
“High Speed HDMI cable” (Type A–Type A plug, up to 1.5 m (4.9 feet) long)
- No sound is output from the camera speakers during HDMI output.
- The [HDMI] socket does not work if you also connect the USB connection cable.
Power can be supplied using the AC adaptor.
- If the camera temperature rises under the any of following conditions, [⚠] may be displayed and the HDMI output may stop.
Wait until the camera cools down.
 - During continuous HDMI output
 - When the ambient temperature is high
- Change the screen mode on your TV if images are displayed with the top or bottom cut off.
- Please also refer to the operating instructions for the TV.





❖ Using VIERA Link (HDMI)

VIERA Link (HDMI) (HDAVI Control™) is a function that allows you to use your remote control for the Panasonic TV for easy operations when the camera has been connected to a VIERA Link compatible device using an HDMI cable for automatic linked operations.

(Not all operations are possible.)



- To use VIERA Link (HDMI), you need to also configure the settings on the TV. For the setting procedure, refer to the operating instructions for the TV.

- 1 Connect the camera to a Panasonic TV compatible with VIERA Link (HDMI) using a commercially available HDMI cable. (→ 426)
- 2 Turn on the camera.
- 3 Turn on the VIERA Link.
 -  ⇒ [] ⇒ [] ⇒ [TV Connection] ⇒ [VIERA Link (CEC)] ⇒ [ON]
- 4 Display the playback screen.
 - Press [].
- 5 Operate with the remote control for the TV.

Power off link

If you turn off the TV with its remote control, the camera will also turn off.

Automatic input switching

If you turn on the camera and then press [], the input of the TV automatically switches to input to which this camera is connected.

Furthermore, when the TV power is in the standby state, it turns on automatically. (When “Power on link” on the TV is set to “Set”)



- Use a “High Speed HDMI cable” with the HDMI logo.
Cables that do not comply with the HDMI standards will not work.
“High Speed HDMI cable” (Type A–Type A plug, up to 1.5 m (4.9 feet) long)
- VIERA Link is a unique Panasonic function built on an HDMI control function using the standard HDMI CEC (Consumer Electronics Control) specification. Linked operations with HDMI CEC compatible devices made by other companies are not guaranteed.
- The camera supports VIERA Link Ver.5. VIERA Link Ver.5 is the standard for Panasonic’s VIERA Link compatible devices. This standard is compatible with Panasonic’s conventional VIERA Link devices.
- Operation using the buttons on the camera will be limited.

Importing Images to a PC

If you connect the camera to a PC, you can copy the recorded images to the PC.

For Windows, install the supplied software “PHOTOfunSTUDIO” to copy your images. (→ 430)

For Mac, copy the files or folders inside the card by dragging and dropping. (→ 434)

Furthermore, use “SILKYPIX Developer Studio” (Windows version or Mac version) to process and edit RAW images, and “LoiLoScope” (Windows version only) to edit videos.

Installing Software

Install the software to perform operations such as organizing and correcting recorded images, processing RAW images, and editing videos.



- To download the software, your PC needs to be able to connect to the internet.
- Downloading may take a while depending on the communication environment.
- Supported OSs are current as of January 2019 and are subject to change.

❖ PHOTOfunSTUDIO 10.1 PE

This software allows you to manage your images. For example, it allows you to import pictures and videos to your PC and then sort them by recording date, model name.

You can also perform operations such as writing images to a DVD, correcting images, and editing videos.

Check the following site and then download and install the software.

https://panasonic.jp/support/global/cs/soft/download/d_pfs1001pe.html
(English only)

Download expiration: March 2024

Operating environment

Supported OS	Windows 10 (32-bit/64-bit) Windows 8.1 (32-bit/64-bit) Windows 7 (32-bit/64-bit) SP1 • For 4K videos and 6K/4K photos, a 64 bit version of the Windows 10/Windows 8.1/Windows 7 OS is required.
CPU	Pentium® 4 (2.8 GHz or higher)
Display	At least 1024×768 (1920×1080 or higher is recommended)
Installed memory	1 GB or more for 32-bit, 2 GB or more for 64-bit
Free hard disk space	450 MB or more for installing the software

- A high-performance PC environment is required to use the playback and editing functions for 4K videos or the picture cropping function for 6K/4K photos. For details, refer to the operating instructions for “PHOTOfunSTUDIO”.
- “PHOTOfunSTUDIO” is not available for Mac.

❖ SILKYPIX Developer Studio SE

This software processes and edits RAW images.

Edited images can be saved in a format (JPEG, TIFF, etc.) that can be displayed on a PC.

Check the following site and then download and install the software.

<http://www.isl.co.jp/SILKYPIX/english/p/>

Operating environment

Supported OS	Windows	Windows 10 Windows 8.1 Windows 7
	Mac	OS X v10.6.8 to v10.11 macOS 10.12 to macOS 10.14

- For more information such as how to use “SILKYPIX Developer Studio”, refer to the Help or the Ichikawa Soft Laboratory’s support website.

❖ 30-Day Full Trial Version of “LoiLoScope”

This software allows you to easily edit videos.

Check the following site and then download and install the software.

<http://loilo.tv/product/20>

Operating environment

Supported OS	Windows	Windows 10 Windows 8.1 Windows 8 Windows 7
--------------	---------	---

- You can download a trial version that can be used for free for 30 days.
- For more information on how to use “LoiLoScope”, refer to the “LoiLoScope” manual available for download at the website.
- “LoiLoScope” is not available for Mac.

Copying Images to a PC

Use “PHOTOfunSTUDIO” to copy recorded images to your PC.

- ❗ • If you are using a Mac, or in any situation where “PHOTOfunSTUDIO” cannot be installed, refer to page 434.
- AVCHD videos may not be imported correctly by copying the files or folders.
 - For Windows, be sure to use “PHOTOfunSTUDIO” to import AVCHD videos.
 - For Mac, you can use “iMovie” to import AVCHD videos. Depending on the recording quality, however, it may not be possible to import them. (For details on “iMovie”, please contact Apple Inc.)

Getting started:

- Turn on the camera and PC.
- Install “PHOTOfunSTUDIO” on PC. (→ 430)

1 Connect the camera and PC with the USB connection cable (C–C or A–C).

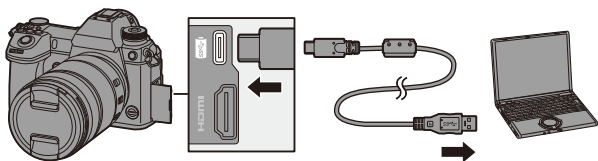

- Plug in/out straight holding onto the plug. (Inserting these at an angle may cause deformation or malfunction)
- Do not connect the cable to the wrong terminals. This may cause a malfunction.

2 Press ▲▼ to select [PC(Storage)] and then press or .

- A message about charging may be displayed. Wait for a while until the message disappears.

3 Copy images to the PC using “PHOTOfunSTUDIO”.

- Do not delete or move the copied files and folders in, for example, Windows Explorer.
Playback and editing using “PHOTOfunSTUDIO” will become no longer possible.

 • If [USB Mode] is set to [PC(Storage)] in the [Setup] ([IN/OUT]) menu, the camera will be automatically connected to the PC without the [USB Mode] selection screen being displayed. (→ 355)

-  • Do not use any other USB connection cables except the supplied USB connection cables (C–C and A–C).
- Take care not to turn off the camera while images are being imported.
 - After importing of the images is completed, perform the operation to safely remove the USB connection cable on the PC.
 - Turn off the camera and disconnect the USB connection cable before removing the card from the camera. Otherwise, the recorded data may be damaged.

❖ Copying to a PC Without Using “PHOTOfunSTUDIO”

Even if you are using a Mac, or in any situation where “PHOTOfunSTUDIO” cannot be installed, you can still copy files and folders by connecting the camera to the PC and then dragging and dropping them to it.

Operating environment

The camera can be connected to a PC running any of the following OSs which can detect mass storage devices.

Supported OS	Windows	Windows 10 Windows 8.1 Windows 8 Windows 7
	Mac	OS X v10.5 to v10.11, macOS 10.12 to macOS 10.14

❖ Folder Structure Inside Card

For Windows, the drive ("LUMIX") is displayed in [Computer]. For Mac, the drive ("LUMIX") is displayed on the desktop.

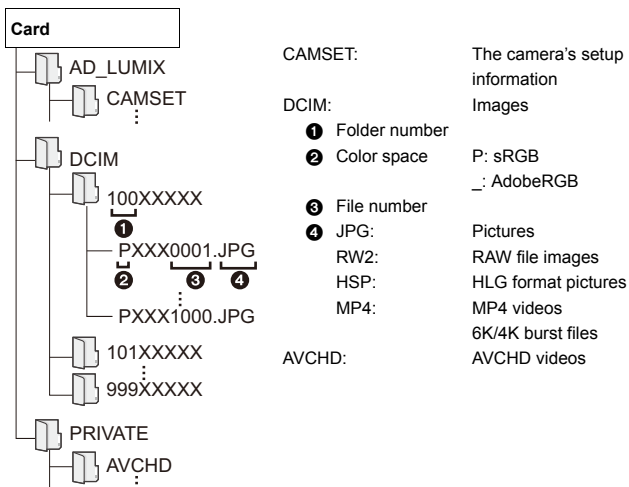

Storing on a Recorder

By connecting the camera to a Panasonic Blu-ray disc recorder or DVD recorder, you can store the pictures and videos.

Getting started:

- Turn on the camera and recorder.
- Images to be stored should be saved on an XQD card and inserted in card slot 1.

1 Connect the camera and recorder with the USB connection cable (C-C or A-C).

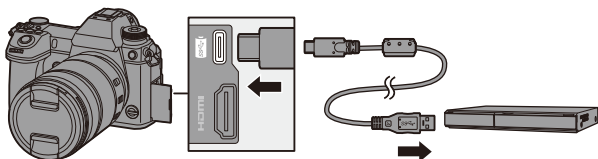

- Plug in/out straight holding onto the plug.
(Inserting these at an angle may cause deformation or malfunction)
- Do not connect the cable to the wrong terminals. This may cause a malfunction.

2 Press ▲▼ to select [PC(Storage)] and then press or .

- A message about charging may be displayed. Wait for a while until the message disappears.

3 Operate the recorder to store the images.



- If [USB Mode] is set to [PC(Storage)] in the [Setup] ([IN/OUT]) menu, the camera will be automatically connected to the recorder without the [USB Mode] selection screen being displayed. (→ [355](#))



- Do not use any other USB connection cables except the supplied USB connection cables (C–C and A–C).
- Take care not to turn off the camera while storage is in progress.
- Images such as 4K videos may not be supported depending on your recorder.
- Turn off the camera and disconnect the USB connection cable before removing the card from the camera. Otherwise, the recorded data may be damaged.
- For the storage and playback procedures, refer to the operating instructions for the recorder.

Tethered Recording

If you install the “LUMIX Tether” camera control software on your PC, you can connect the camera to the PC via USB and then control the camera from the PC and record while checking the live view on the PC screen (tethered recording).

In addition, you can output via HDMI to an external monitor or TV during tethered recording.

Installing Software

❖ “LUMIX Tether”

This software is for controlling the camera from a PC.

It allows you to change various settings and to record remotely and then save the images to the PC.

Check the following site and then download and install the software.

https://panasonic.jp/support/global/cs/soft/download/d_lumixtether.html

Operating environment

Supported OS	Windows	Windows 10, Windows 8.1, Windows 7
	Mac	OS X v10.10 to v10.11, macOS 10.12, macOS 10.13
Interface	USB port (SuperSpeed USB (USB 3.0))	



- Supported OSs are current as of January 2019 and are subject to change.
- To download the software, your PC needs to be able to connect to the internet.
- Downloading may take a while depending on the communication environment.
- For how to operate the software, refer to the operation guide for “LUMIX Tether”.

Operating the Camera from a PC

- To output via HDMI to an external monitor or TV, connect the camera and external monitor or TV with an HDMI cable. (→ 426)

Getting started:

- Turn on the camera and PC.
- Install “LUMIX Tether” on PC.

1 Connect the camera and PC with the USB connection cable (C–C or A–C).

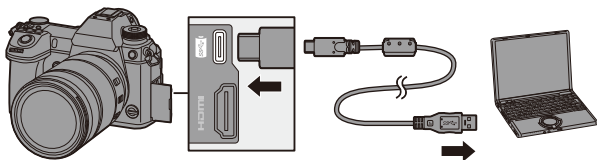

- Plug in/out straight holding onto the plug.
(Inserting these at an angle may cause deformation or malfunction)
- Do not connect the cable to the wrong terminals. This may cause a malfunction.

2 Press ▲▼ to select [PC(Tether)] and then press or .

- [] is displayed on the screen.
- A message about charging may be displayed. Wait for a while until the message disappears.

3 Use “LUMIX Tether” to operate the camera from the PC.



- If [USB Mode] is set to [PC(Tether)] in the [Setup] ([IN/OUT]) menu, the camera will be automatically connected to the PC without the [USB Mode] selection screen being displayed. (→ [355](#))



- Do not use any other USB connection cables except the supplied USB connection cables (C–C and A–C).
- The Wi-Fi/Bluetooth functions are not available while there is a PC connection with [PC(Tether)].



Printing

If you connect the camera to a printer that supports PictBridge, you can select pictures on the camera's monitor and then print them.

Getting started:

- Turn on the camera and printer.
- Set the print quality and other settings on the printer.

1 Display the playback screen.

- Press [▶].
- Images are displayed separately by card slot.
To switch the card to display, after pressing [⏏], press ▲▼ to select [Card Slot 1(XQD)] or [Card Slot 2(SD)], and then press  or .
- You can also select the card to be displayed using the Fn button [Card Slot Change] (→ 284).
- The card for printing cannot be changed after connecting to the printer.

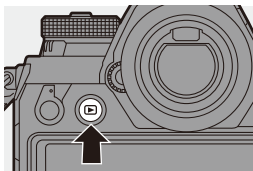

2 Connect the camera and printer with the USB connection cable (C-C or A-C).

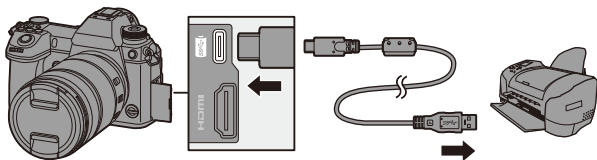

- Plug in/out straight holding onto the plug.
(Inserting these at an angle may cause deformation or malfunction)
- Do not connect the cable to the wrong terminals. This may cause a malfunction.

3 Press ▲▼ to select [PictBridge(PTP)] and then press





 or .

- A message about charging may be displayed. Wait for a while until the message disappears.

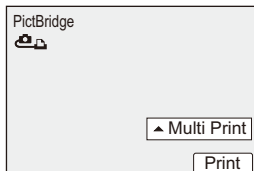
4 Press ◀▶ to select a picture and then press or .

- To print multiple pictures, press ▲, set the picture selection method, and then select pictures.



[Multi Select]	Selects the picture to print. <ol style="list-style-type: none"> 1 Press ▲▼◀▶ to select a picture and then press  or . • To cancel the setting, press  or  again. 2 Press [DISP.] to end selection.
[Select All]	Prints all the stored pictures.
[Rating]	Prints all pictures with [Rating] levels from [★1] to [★5].

5 Set the printer settings.

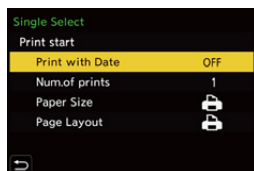

6 Start printing.

- Select [Print start] and then press

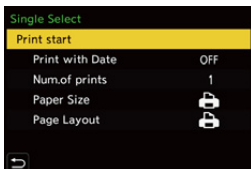
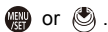

❖ Setting Items (Print Settings)

[Print start]	Starts printing.
[Print with Date]	Sets printing with date. <ul style="list-style-type: none"> • If the printer does not support date printing, the date cannot be printed.
[Num.of prints]	Sets the number of prints to be printed (up to 999).
[Paper Size]	Sets the paper size.
[Page Layout]	Sets whether to add borders and how many images to be printed on each sheet of paper.



- If [USB Mode] is set to [PictBridge(PTP)] in the [Setup] ([IN/OUT]) menu, the camera will be automatically connected to the printer without the [USB Mode] selection screen being displayed. (→ 355)



- Do not use any other USB connection cables except the supplied USB connection cables (C–C and A–C).
- Take care not to turn off the camera while printing is in progress.
- When connecting with the printer is not possible, set [USB Power Supply] to [OFF] and then try connecting again. (→ 355)
- Do not disconnect the USB connection cable while [🚫] (Cable disconnect prohibit icon) is displayed.
- Disconnect the USB connection cable after printing.
- Turn off the camera and disconnect the USB connection cable before removing the card from the camera. Otherwise, the recorded data may be damaged.
- To print images with paper size and layout settings not supported by the camera, set the [Paper Size] and [Page Layout] to [📄] and then select the desired settings on the printer.
(For details, refer to the operating instructions for your printer.)
- If a yellow [●] is displayed during printing, the camera is receiving an error message from the printer.
After printing finishes, check that there is no problem with the printer.
- If the number of prints is high, the pictures may be printed in batches. In this case, the remaining number of prints indicated may differ from the number set.
- When you print RAW images, JPEG images that were recorded at the same time will be printed. If JPEG images were not recorded, printing is not possible.
- Recorded images cannot be printed while you are using the following functions:
 - Video recording/[6K/4K Burst]/[Post-Focus]
 - [HLG Photo]

17. Materials

Using Optional Accessories

- For information on the external flash, refer to page 216.
- For information on the external microphone, refer to page 253.
- For information on the XLR Microphone Adaptor, refer to page 256.
- Some optional accessories may not be available in some countries.

Battery Grip (Optional)

When mounted on the camera, the Battery Grip (DMW-BGS1: optional) improves ease of operation and grip when the camera is held vertically. Also, inserting a battery into the Battery Grip provides a stable supply of power even for long periods of recording.

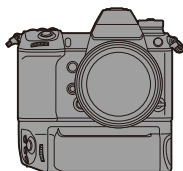



❖ Selecting Battery Usage Priority

Selects which battery to use first when the batteries are installed in both the camera and the Battery Grip.

The order of battery charging using the camera body is also determined by this setting.

Getting started:

- Turn the camera off, and remove the cover for the battery grip connector.

- 1 Attach the Battery Grip to the camera.
- 2 Turn on the camera.
- 3 Set the battery use priority.
 -  ⇒ [] ⇒ [] ⇒ [Battery Use Priority]

[BODY]	The battery in the camera is used first.
[BG]	The battery in the Battery Grip is used first.



- When the battery in the Battery Grip is used, [**BG**] is displayed on the screen.
- You can assign functions of your choice to the [Fn] button, [WB] button, [ISO] button, and [] button on the Battery Grip. (→ 278)
- Refer to the operating instructions for the Battery Grip for details.

Shutter Remote Control (Optional)

You can connect the Shutter Remote Control (DMW-RS2: optional) to use the camera as follows:

- Fully pressing the shutter button without camera shake
- Securing the shutter button during bulb recording and burst recording
- Start/end the video recording

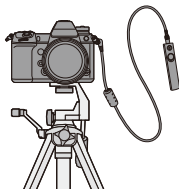

❖ Shutter Remote Control Video Rec. Button

You can disable the video rec. button when not recording a video to prevent erroneous operation.



⇒ [] ⇒ [] ⇒ Select [Video Rec. Button (Remote)]

Settings: [ON]/[OFF]



- Always use a genuine Panasonic Shutter Remote Control (DMW-RS2: optional).
- Refer to the operating instructions for the Shutter Remote Control for details.

AC Adaptor (Optional)/DC Coupler (Optional)

With an AC Adaptor (DMW-AC10: optional) and DC Coupler (DMW-DCC16: optional), you can perform recording and playback without worrying about the remaining battery charge.







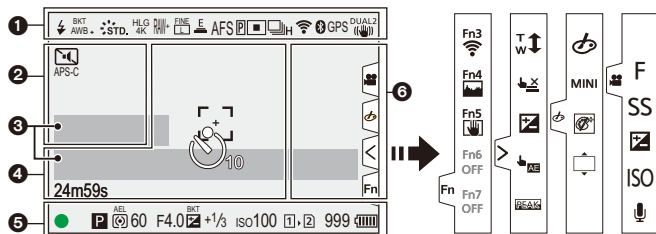

- Be sure to purchase both an AC Adaptor and a DC Coupler as a set. They cannot be used independently of one another.
- When the DC Coupler is being mounted, the DC Coupler cover opens, so the structure ceases to be dust and splash resistant. Do not allow sand, dust and water droplets to adhere to or enter the camera. After use, confirm that no foreign objects are adhering to the DC Coupler cover, then firmly close the cover.
- For details, refer to the operating instructions for the AC Adaptor and DC Coupler.

Monitor/Viewfinder Displays

- The screen is an monitor display example of when [LVF/Monitor Disp. Set] is set to .

Recording Screen



	Flash mode (→ 220)
	Flash setting (→ 223, 226)
AWBc AWBw 	White balance (→ 194)
	White Balance Bracket, White Balance Bracket (Color Temperature) (→ 160)
AWB + AWB -	Adjusting the white balance (→ 197)
	Photo Style (→ 199)
*EXPS	Filter setting (→ 204)/ Filter effect adjustment (→ 204)

HLG 8K HLG 4K	HLG Photo (→ 214)
RAW+ FINE L STD. M	Picture quality (→ 85)/ Picture size (→ 83)
EXM	Extended Tele Conversion (→ 122)
MP4 FHD60p	Recording file format/ Recording quality (→ 233)
E	Electronic shutter (→ 170)
180fps	High Speed Video (→ 247)
AFS AFC MF	Focus mode (→ 91, 117)
BKT AFS	Focus Bracket (→ 159)
AFL	AF Lock (→ 191)
P	Peaking (→ 310)

	AF mode (→ 98)
	Burst (→ 126)
	6K/4K Photo (→ 130)
	Post-Focus (→ 161)
	Time Lapse Shot (→ 145)
	Stop Motion Animation (→ 148)
	Self-timer (→ 153)
	Connected to Wi-Fi
	Connected to Bluetooth (→ 375)
GPS	Location logging (→ 392)
	Image stabilizer (→ 172)
	Camera shake alert (→ 173)

2

PRE	Pre-Burst recording (→ 134)
APS-C PIXEL PIXEL	Image area of video (→ 238)
	Multiple exposures (→ 316)
	Silent mode (→ 169)
FLICKER	Flicker Decrease (Photo) (→ 315)
	High Resolution mode (→ 210)
	Overlay indication (→ 347)
LMT OFF	Sound recording level limiter ([OFF]) (→ 243)

	External microphone (→ 253)
XLR	XLR microphone adaptor setting (→ 256)
	HLG View Assist (→ 347)

3

Exposure meter (→ 344)
Sound recording level (→ 243)

4

	AF area (→ 112)
	Histogram (→ 340)
+	Spot metering target (→ 178)
+	Center marker (→ 341)
	Self-timer (→ 153)
	Lock lever (→ 65)
8m30s	Elapsed recording time (→ 230)
LVF/ MON/AUTO	Automatic viewfinder/monitor switching (→ 67)
	Image being sent (→ 390)

5

	Focus (green light on) (→ 59)/Recording state (red light on) (→ 211, 230)
LOW 	Focus (in low light situations) (→ 93)
STAR 	Focus (Starlight AF) (→ 93)
	Adjusting the Flash Output (→ 224)
iA P A S M P C3:1 P	Recording mode (→ 61)

	Program Shift (→ 180)
	Metering mode (→ 178)
	AE Lock (→ 191)
60	Shutter speed (→ 59)
F4.0	Aperture value (→ 59)
^{BKT} F4.0	Aperture Bracket (→ 158)
^{BKT} +1/3	Exposure compensation value (→ 189) Exposure Bracket (→ 158)
+1	Manual Exposure Assist (→ 186)
iso100	ISO sensitivity (→ 192)
	Card access indication (lights red) (→ 230)
	Relay recording (→ 87)
	Backup recording (→ 87)
	Allocation recording (→ 87)
	No card
	Card full
999	Number of recordable pictures (→ 482)
r20	Number of pictures that can be taken continuously (→ 128)
8m30s	Available recording time (→ 483)
	Battery indication (→ 42)
	Power supply (→ 40)
	Battery Grip (→ 445)

6

Touch Tab (→ 333)	
	Fn button (→ 285)
	Touch Zoom (→ 123)
	Touch Shutter (→ 80)
	Exposure compensation (→ 189)
	Touch AE (→ 81)
	Peaking (→ 310)
(→ 245)	
	Type of defocus ([Miniature Effect]) (→ 207)
	One Point Color (→ 208)
	Light source position ([Sunshine]) (→ 208)
	Filter effect adjustment (→ 204)
	Filter on/off (→ 206)
MINI	Filter setting (→ 204)
F	Aperture value (→ 59)
SS	Shutter speed (→ 59)
	Exposure compensation (→ 189)
ISO	ISO sensitivity (→ 192)
	Sound recording level adjustment (→ 243)
	Temperature rise warning icon (→ 460)

❖ Control Panel



1



	Recording mode (→ 61)
1/60	Shutter speed (→ 59)
F4.0	Aperture value (→ 59)
	Battery indication (→ 42)
	Power supply (→ 40)
	Battery Grip (→ 445)
	Wi-Fi/Bluetooth (→ 370)

2

	ISO sensitivity (→ 192)
	Exposure compensation value (→ 189)
	Manual Exposure Assist (→ 186)
	Flash mode (→ 220)
	Flash setting (→ 223, 224, 226)









3

	Single (→ 125)
	Burst (→ 126)
	6K/4K Photo (→ 130)
	Post-Focus (→ 161)
	Time Lapse Shot (→ 145)
	Stop Motion Animation (→ 148)
	Self-timer (→ 153)
	High Resolution mode (→ 210)
AFS AFC MF	Focus mode (→ 91, 117)
	AF mode (→ 98)
FINE STD. RAW	Picture quality (→ 85)
APS-C PIXEL PIXEL	Image area of video (→ 238)

	Recording file format/ Recording quality (→ 233)
	Picture size/Aspect ratio (→ 83)
HLG 8K HLG 4K	HLG Photo (→ 214)
Fn 	Fn button settings (→ 278)

r20	Number of pictures that can be taken continuously (→ 128)
r8m30s	Available recording time (→ 483)
----	No card

4

	Photo Style (→ 199)
AWB AWBc AWBw 	White balance (→ 194)
	i.Dynamic Range (→ 307)
	Metering mode (→ 178)
	Relay recording (→ 87)
	Backup recording (→ 87)
	Allocation recording (→ 87)
	No card
	Card full
999	Number of recordable pictures (→ 482)

Playback Screen

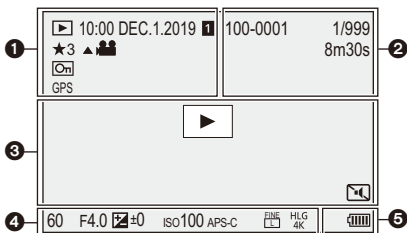

①

	Playback status
DEC.1.2019 10:00	Recording date and time (→ 53)
1 2	Card slot (→ 46)
★3	Rating (→ 365)
	Video playback (→ 261)
	Protected picture (→ 365)
GPS	Location logging (→ 392)
	Obtaining information
	Cable disconnect prohibit icon (→ 444)
	Marker available indication (→ 141, 142)
	Reduce Rolling Shutter (→ 140)
	Saving pictures from a 6K/ 4K burst file (→ 138)
	Saving pictures from a Post-Focus image (→ 164)

	Group images (→ 268)
8m30s	Elapsed playback time (→ 261)

②

100-0001	Folder/file number (→ 435)
1/999	Image number/Total number of images
9 pic.	Number of group images
8m30s	Video recording time (→ 261)
	High speed video (→ 247)
	HLG view assist (→ 347)



③

	Playback (video) (→ 261)
	Wi-Fi/Bluetooth connection state
	Silent mode (→ 169)

4

Recording information

5

	Battery indication (→ 42)
	Power supply (→ 40)
	Battery Grip (→ 445)

Detailed information display

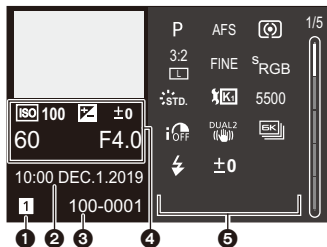

- 1 Card slot (→ 46)
- 2 Recording date and time (→ 53)
- 3 Folder/file number (→ 435)
- 4 Recording information (basic)
- 5 Recording information (advanced)

Photo Style display

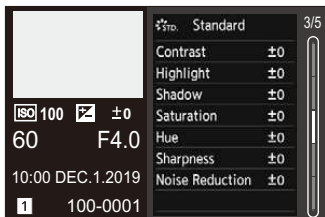

White balance display

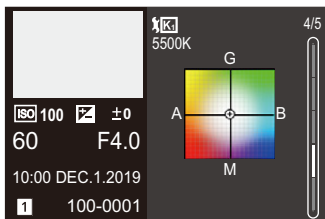

Histogram display

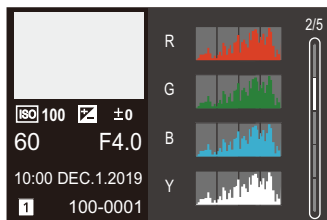

Lens information display

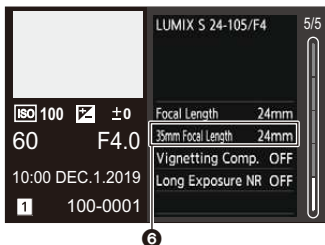

- 6 The focal length corresponding to the angle of view when using a full-frame lens with the [Aspect Ratio] set to [3:2]

Message Displays

Meanings of main messages displayed on the camera screen, and response methods.

❖ Card

[Memory Card Error]/[Format this card?]

- It is a format that cannot be used with the camera.
Either insert another card, or back up any necessary data before formatting. (→ 48)

[Memory Card Error]/[This memory card cannot be used]

- Use a card compatible with the camera. (→ 22)

[Insert memory card again.]/[Try another card]

- Unable to access the card. Reinsert the card.
- Insert a different card.

[Read Error]/[Write Error]/[Please check the card]

- Failure to read or write data.
Turn off the camera, reinsert the card, and then turn it on again.
- The card may be broken.
- Insert a different card.

[Recording was cancelled due to the limitation of the writing speed of the card]

- Insufficient SD card write speed for video, 6K/4K photo, or Post-Focus recording.
Use an SD card of a supported Speed Class. (→ 23)
- If the recording stops even when you are using an SD card that meets the specified Speed Class rating, the data writing speed of the SD card is getting slow.
We recommend backing up data, and formatting (→ 48).
- Depending on the type of card, recording may stop part way.

[Now writing]

- Card door or battery door is opened while writing to a card. Wait until writing is finished, then turn the camera off and remove.

❖ Lens

[The lens is not attached properly. Do not push lens release button while lens is attached.]

- Remove the lens once, and then attach it again without pressing the lens release button. (→ 49)
Turn on the camera again, and if it is still displaying, contact the dealer.

[Lens attachment failed. Please make sure the lens is attached correctly.]

- Remove the lens from the camera body and gently wipe the contacts on the lens and the camera body using a dry cotton swab.
Attach the lens, turn on the camera again, and if it is still displaying, contact the dealer.

❖ Battery

[This battery cannot be used]

- Use a genuine Panasonic battery.
If this message is displayed even when a genuine Panasonic battery is used, contact the dealer.
- If the terminal of the battery is dirty, remove the dirt and dust from them.

❖ Wi-Fi

[Failed to connect wireless access point]/[Connection failed]/[No destination found]

- The wireless access point information set on the camera is wrong.
Check the authentication type and encryption key. (→ 415)
- Radio waves from other devices may block the connection to a wireless access point.
Check the status of other devices that are connected to the wireless access point as well as the status of other wireless devices.

[Connection failed. Please retry in a few minutes.]/[Network disconnected. Transfer stopped.]

- Radio waves from the wireless access point are getting weak.
Perform the connection closer to the wireless access point.
- Depending on the wireless access point, connection may be automatically disconnected after specific time has passed.
Reconnect the connection again.

[Connection failed]

- Change the access point to connect to in the smartphone Wi-Fi settings to the camera.

❖ Others

[Some pictures cannot be deleted]/[This picture cannot be deleted]

- Images that do not comply with the DCF standard cannot be deleted.
Back up any necessary data before formatting the card. (→ 48)

[Cannot be set on this picture]

- Images that do not comply with the DCF standard cannot be edited.

[A folder cannot be created]

- The maximum number of folder numbers has been reached, so new folders cannot be created.
Back up any necessary data before formatting the card. (→ 48)
After formatting, execute [File Number Reset] in the [Setup] ([Card/File]) menu to reset the folder number to 100. (→ 90)

[Please turn camera off and then on again]/[System Error]

- Turn off and on the camera.
If the message is displayed even when doing this several times, contact the dealer.

Troubleshooting

First, try out the following procedures (→ 459 to 469).

If the problem is not resolved, it may be improved by selecting [Reset] (→ 76) on the [Setup] ([Setting]) menu.

Power, Battery

The camera turns off automatically.

- [Power Save Mode] is enabled. (→ 44)

The battery becomes flat too quickly.

- When [6K/4K Pre-Burst] or [Pre-Burst Recording] is set, the battery drains faster.
Set these settings only when recording.
- When connected to Wi-Fi, the battery drains quickly.
Turn the camera off frequently such as by using [Power Save Mode] (→ 44).

Recording

Recording stops before finishing.

Cannot record.

Cannot use some functions.

- In high ambient temperatures or if the camera is used for continuous recording, the temperature of the camera will rise.
To protect the camera against a rise in temperature, after [] is displayed, recording will be stopped, and the following functions will not be available for a time. Wait until the camera cools down.
 - [6K/4K PHOTO]
 - [Post-Focus]
 - Video recording
 - [AF-Point Scope]
 - HDMI output
 - Power supply via the USB connection cable

Cannot record images.

The shutter will not operate immediately when the shutter button is pressed.

- If [Focus/Shutter Priority] is set to [FOCUS], then recording will not take place until focus is achieved. (→ [329](#))

The recorded image is whitish.

- Images may look whitish when the lens or image sensor gets dirty with fingerprints or similar.
If the lens is dirty, turn the camera off, then wipe the lens surface with a soft, dry cloth.
For information about how to clean the image sensor, refer to page [472](#).

The recorded image is too bright or dark.

- Ensure AE Lock is not set where it is not appropriate. (→ [191](#))

Multiple images are recorded at once.

- When drive mode is set to [I] (Burst Shot 1) or [II] (Burst Shot 2), pressing and holding the shutter button will take burst pictures. (→ 125)
- When bracketing is set, then pressing the shutter button records multiple images while automatically changing the settings. (→ 155)

The subject is not focused properly.

- Confirm the following details:
 - Is the subject outside of the focus range?
 - Is [Shutter AF] set to [OFF]? (→ 332)
 - Is [Focus/Shutter Priority] set to [RELEASE]? (→ 329)
 - Is AF Lock (→ 191) set where it is not appropriate?

The recorded image is blurred.**The stabilizer is not effective.**

- The shutter speed will become slower and the stabilizer function may not work properly when recording in dark places.
In these cases, use a tripod and the self-timer when recording.

The recorded image looks rough.**Noise appears on the picture.**

- Try the following:
 - Reduce the ISO sensitivity. (→ 192)
 - Increase [Noise Reduction] of [Photo Style] to the positive direction, or adjust each item other than [Noise Reduction] to the negative direction. (→ 201)
 - Set [Long Exposure NR] to [ON]. (→ 306)

The subject appears distorted on the image.

- When a moving subject is recorded while using the following functions, the subject may appear distorted in the picture:
 - [ELEC.]
 - Video recording
 - [6K/4K PHOTO]

This is a characteristic of the CMOS sensor that is the image sensor of the camera, and is not a malfunction.

Striping or flicker may appear under lighting such as fluorescent lighting and LED lighting fixture.

- This is characteristic of CMOS sensors which serve as the camera's pickup sensors.
This is not a malfunction.
- When using the electronic shutter (→ 170), lowering the shutter speed may reduce the effect of the horizontal stripes.
- If flicker is noticeable when recording pictures, set [Flicker Decrease (Photo)]. (→ 315)
- If flicker or horizontal stripes are noticeable when recording video, this can be mitigated by fixing the shutter speed.
Either set [Flicker Decrease (Video)] (→ 320), or record in [P_{CM}] mode (→ 244).



Stripes appear in high ISO sensitivity.

- Stripes may appear in high ISO sensitivity or depending on the lens you use.
Decrease the ISO sensitivity. (→ 192)

The brightness or coloring of the recorded image is different from the actual scene.

- When recording under fluorescent or LED lighting fixture, etc., increasing the shutter speed may introduce slight changes to brightness or coloring.
These are a result of the characteristics of the light source and do not indicate a malfunction.
- When recording subjects in extremely bright locations or recording under fluorescent lighting, LED lighting fixture, mercury lamp, sodium lighting, etc., the coloring or screen brightness may change or horizontal striping may appear on the screen.

Bright spot not in subject is recorded.

- Pixels may be missing from the image sensor.
Perform [Pixel Refresh]. (→ 359)

Cannot set [Silent Mode] to [OFF].

- At the time of purchase, [Silent Mode] is registered to the Fn lever.
Switch the Fn lever to [MODE1]. (→ 286)

Video

Cannot record videos.

- When using a large capacity card, you may not be able to record for a while after turning on the camera.

Video recording stops in the middle.

- Recording video using the SD card requires an SD card of a supported speed class. Use a compatible SD card. (→ 23)

In videos, abnormal clicking and buzzing sounds are recorded.

The recorded audio is very quiet.

- Depending on the recording conditions or the lens used, the sound of aperture and focus actions may be recorded in videos. You can set the focus operation during video recording to [OFF] in [Continuous AF] (→ 239).
- Do not block the microphone hole during video recording.

An operation sound is recorded in a video.

- We recommend setting the [P/M] mode and recording with touch operation if you are bothered about the operation sounds during recording. (→ 245)

Playback

Cannot play back.

There are no recorded pictures.

- Folders and images processed on a PC cannot be played on the camera. We recommend using the software “PHOTOfunSTUDIO” to write images from the PC to the card.

Red part of the recorded image has changed color to black.

- When Red-Eye Removal ([RE] or [RE]) is performed, red parts may be corrected to black. We recommend recording images with the flash mode set to [RE] or [Red-Eye Removal] set to [OFF]. (→ 225)

Monitor/Viewfinder

The monitor/viewfinder turns off when the camera is turned on.

- If no operations are performed during the set time period, [Auto LVF/Monitor Off] (→ 44) is activated, and the Monitor/Viewfinder turns off.
- When an object or your hand is positioned near the eye sensor, the Monitor display may switch to the Viewfinder display.

It may flicker for an instant or the brightness of the screen may change significantly for an instant.

- This occurs when the shutter button is pressed halfway, or when the subject brightness changes, making the lens aperture change.
This is not a malfunction.

Cannot switch between the monitor and viewfinder even when [LVF] is pressed.

- When the camera is connected to a PC or printer, it is not possible to switch to the viewfinder display.

Unevenly bright parts or irregular colors appear on the viewfinder.

- The viewfinder of the camera is built with OLED components. Screen burn-in may occur on the screen/viewfinder when a same image is displayed for a long period of time, but it does not affect the recorded images.

The coloring of the viewfinder differs from the actual tone.

- This is characteristic of the viewfinder of the camera and not a malfunction.
It does not affect the recorded images.

Flash

The flash does not fire.

- The flash does not fire when using the following functions:
 - Video recording (→ 230)/[6K/4K PHOTO] (→ 130)/[Post-Focus] (→ 161)
 - [ELEC.] (→ 170)/[Silent Mode] (→ 169)/[High Resolution Mode] (→ 210)
 - [Filter Settings] (→ 204)

Wi-Fi Function

A Wi-Fi connection cannot be established.

Radio waves get disconnected.

Wireless access point is not displayed.

General tips for using a Wi-Fi connection

- Use within the communication range of the device to be connected.
- Usage near devices that utilize the 2.4 GHz frequency such as microwave ovens and cordless telephones may result in the radio wave being lost.
Use the camera at a sufficient distance from these devices.
- When the remaining battery level is low, it may not be possible to connect to or maintain communication with other devices.
(A message such as [Communication error] is displayed.)
- If you place the camera on a metal table or shelf, the radio waves may be adversely affected. In such cases, you may not be able to establish a connection.
Move the camera away from the metal surface.

Wireless access point

- Confirm that the connected wireless access point can be used.
- Confirm the radio wave conditions of the wireless access point.
 - Move the camera closer to the wireless access point.
 - Change the location and angle of the wireless access point.
- Depending on the wireless access point, the radio wave may not be displayed even though it is present.
 - Turn off and then on the wireless access point.
 - If the wireless channel of the wireless access point cannot be set automatically, manually set the channel supported by the camera.
 - If the wireless access point SSID is set not to broadcast, it may not be detected.
Enter the SSID, and then connect. (→ 415)

The camera is not displayed in the Wi-Fi setting screen of the smartphone.

- From the Wi-Fi setting menu on the smartphone, turn off and then on the Wi-Fi function.

When trying to connect to a PC by Wi-Fi, this does not recognize the user name and password, and connection is not possible.

- Depending on the version of the OS, there are two types of user account (local account/Microsoft account).

Ensure you use the local account user name and password.

The PC is not recognized when I use a Wi-Fi connection.

The camera cannot be connected to the PC using the Wi-Fi function.

- At the time of purchase, this camera is set to use a workgroup name of "WORKGROUP".
If you have changed the workgroup name of the PC, this will not be recognized.
In the [Wi-Fi Setup] menu, [PC Connection], change the workgroup name of the PC to which to connect. (→ 421)
- Check that the login name and password are correctly typed.
- When the clock settings of the PC connected to the camera differs considerably from those of the camera, the camera cannot be connected to the PC depending on the OS.
 - Confirm that the [Clock Set]/[Time Zone] settings of the camera match the time, date, and time zone settings of the Windows or Mac.
If there are considerable differences, correct them.

Images cannot be transmitted to the web service.

- Confirm that the login information (login ID/user name/email address/password) is correct.

It takes time to transmit an image to the web service.

Transmission of the image fails midway.

Some images cannot be transmitted.

- Is the size of the image too large?
 - Reduce the image size at [Size] (→ 419), and then send.
 - Transmit after dividing the video with [Video Divide] (→ 276).
- It may take longer time to transmit when distance to the wireless access point is far.
Transmit closer to the wireless access point.
- File format of the video that can be sent differs depending on the destination.
(→ 397)

I have forgotten the password for the Wi-Fi.

- In the [Setup] ([Setting]) menu, [Reset], reset network settings. (→ 76)
However, all information set in [Wi-Fi Setup] and [Bluetooth] will also be reset.
(With the exception of [LUMIX CLUB])

TV, PC, Printer**No image on the TV.****The TV screen is blurry or not colored.**

- Confirm the connection with the TV. (→ 426)
- Set the TV input to HDMI input.

The TV images are displayed with gray bands.

- Depending on the [Aspect Ratio], gray bands may be displayed on the top and bottom or the left and right of the images. You can change the band color in [Background Color(Playback)] in [TV Connection] of the [Setup] ([IN/OUT]) menu. (→ 358)

VIERA Link is not working.

- Check that the [VIERA Link (CEC)] of the camera is set to [ON]. (→ 357)
- Check the VIERA Link setting on the connected device.
- Turn off and on the camera.

Cannot communicate with the PC.

- Set the [USB Mode] of the camera to [PC(Storage)]. (→ 355)
- Turn the camera off and on.

**The card is not recognized by the PC.
(SDXC memory card is used.)**

- Check if your PC supports SDXC memory cards.
- When connecting the camera to the PC, a message recommending that the card be formatted may be displayed. Do not format the card.
- If the [Access] displayed on the monitor does not disappear, turn off the camera and disconnect the USB connection cable, and then connect again.

Cannot print when the camera is connected to a printer.

- Pictures cannot be printed using a printer that does not support PictBridge.
- Set to [PictBridge(PTP)] in [USB Mode]. (→ [355](#))

The ends of the images are cut at printing.

- If the printer has trimming or borderless printing functions, cancel these settings before printing.
(Refer to the operating instructions for your printer.)
- Depending on the photo studio, images recorded with their aspect ratio set to 16:9 can be printed at sizes in 16:9 aspect ratio. Ask the photo studio in advance.

Others

An alarm sounds when the card door or battery door is opened.

- An alarm may sound when a door is opened while writing to a card. Wait until writing finishes, then turn the camera off and remove the card or battery.

When I shake the camera, I hear a rattling sound from the camera.

- The sound is caused by the in-body stabilizer. This is not a malfunction.

When I shake the camera, I hear a rattling sound from the attached lens.

- Depending on the lens you attach, it may move inside and create a sound. This is not a malfunction.

The camera makes a noise when it is turned on.

- This is the noise of the dust reduction function working (→ [472](#)); it is not a malfunction.

There is a sound from the lens unit.

- The lens movement and aperture operation emit sound when turning the camera on or off; this is not a malfunction.
- This is the sound of aperture operation when brightness changes; this is not a malfunction.

A red lamp sometimes lights when the shutter button is pressed halfway.

- In dark places, the AF Assist Lamp (→ 309) lights red to make it easier to focus on a subject.

An unreadable language was selected by mistake.

- Reselect the language from the menu using the following procedure:

 ⇒ [] ⇒ [] ⇒ [] ⇒ Select desired language (→ 359)

The camera becomes warm.

- During use, the camera may get warm, but this does not affect performance or quality.

The clock is wrong.

- When the camera is left for a long time, the clock may reset.
Reset the clock. (→ 53)

Cautions for Use

❖ The camera

Keep this unit as far away as possible from electromagnetic equipment (such as microwave ovens, TVs, video games etc.).

- If you use this unit on top of or near a TV, the pictures and/or sound on this unit may be disrupted by electromagnetic wave radiation.
- Do not use this unit near cell phones because doing so may result in noise adversely affecting the pictures and/or sound.
- Recorded data may be damaged, or pictures may be distorted, by strong magnetic fields created by speakers or large motors.
- Electromagnetic wave radiation may adversely affect this unit, disturbing the pictures and/or sound.
- If this unit is adversely affected by electromagnetic equipment and stops functioning properly, turn this unit off and remove the battery or disconnect AC adaptor. Then reinsert the battery or reconnect AC adaptor and turn this unit on.

Do not use this unit near radio transmitters or high-voltage lines.

- If you record near radio transmitters or high-voltage lines, the recorded pictures and/or sound may be adversely affected.

Always use the supplied cords and cables.

If you use optional accessories, use the cords and the cables supplied with them.

Do not extend the cords or the cables.

Keep items away from the magnetic parts (A/B/C) that are easily influenced by magnetism.

- The effects of the magnets may cause items like bank cards, commuter cards, and clocks to cease functioning correctly.

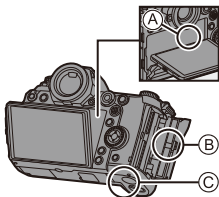

Do not spray the camera with insecticides or volatile chemicals.

- If the camera is sprayed with such chemicals, the body of the camera may be damaged and the surface finish may peel off.

Do not keep products made of rubber, PVC or similar materials in contact with the camera for a long period of time.**❖ When using in cold places or at low temperatures**

- Skin burns may result if you leave the metal parts of the camera in direct contact with the skin for long periods of time at cold places (environments with temperatures at or below 0 °C (32 °F), such as ski resorts or places at high altitude).

Use gloves or similar when using it for long periods.

- The performance of the battery (number of recordable pictures/operating time) may decrease temporarily at temperatures between –10 °C and 0 °C (14 °F and 32 °F). Keep the battery warm as you are using by keeping it inside your cold weather gear or clothes. Battery performance will recover when the internal temperature rises again.
- The battery cannot be charged at temperatures below 0 °C (32 °F).
An error message is shown on the charger or on the camera body when charging is not possible.
 - When charging with the charger: The 50% charged lamp blinks rapidly.
 - When charging in the camera body: “Err (E r r)” is displayed on the status LCD.
- If using in cold locations, do not allow water droplets and snow to remain on the camera.

If these are left on the camera, water may freeze in gaps in the camera on/off switch, speaker, and microphone, making these parts difficult to move, and/or leading to reduced volume. This is not a malfunction.

❖ Cleaning

Before cleaning the camera, remove the battery or the DC Coupler, and disconnect the power plug from the electrical outlet. Then wipe the camera with a dry, soft cloth.

- When the camera is soiled badly, it can be cleaned by wiping the dirt off with a wrung wet cloth, and then with a dry cloth.
- Do not use solvents such as benzine, thinner, alcohol, kitchen detergents, etc., to clean the camera, since it may deteriorate the external case or the coating may peel off.
- When using a chemical cloth, be sure to follow the accompanying instructions.

❖ Dirt on the image sensor

If dirt gets inside the mount when changing lenses, depending on the recording conditions, it may adhere to the image sensor and appear on the recorded picture.

To prevent debris or dust adhering to internal parts of the body, avoid changing the lens in a dusty environment and always fit the body cap or a lens when storing the camera.

Remove any dirt on the body cap before attaching it.

Dust reduction function

The camera has a dust reduction function that will blow off the dirt and dust that have affixed to the front of the image sensor.

This function will function automatically when the camera is turned on, but if the dirt is particularly noticeable, from the [Setup] ([Others]) menu, perform [Sensor Cleaning].

Removing dirt on the image sensor

The image sensor is very precise and delicate, so be sure to observe the following when you do have to clean it yourself.

- Blow dust off the surface of the image sensor using a commercially available blower. Do not blow the dust off with excessive power.
- Do not put the blower brush further inside than the lens mount.
- Do not let the blower brush touch the image sensor as the image sensor may get scratched.
- Do not use any objects except a blower brush to clean the image sensor.
- If you cannot remove the dirt or dust with the blower, consult the dealer or Panasonic.

❖ Cleaning the Viewfinder

If the viewfinder is dirty, then remove the eye cup and clean.

While pushing the eye cup lock lever (①), rotate the eye cup in the direction of the arrow and remove (②).

Blow dirt off the surface of the viewfinder using a commercially available blower, then lightly wipe with a soft, dry cloth.

- After cleaning, align the fitting marks (△) (③) and rotate the eye cup in the direction of the arrow until a click is heard (④).
- Be careful not to lose the eye cup.

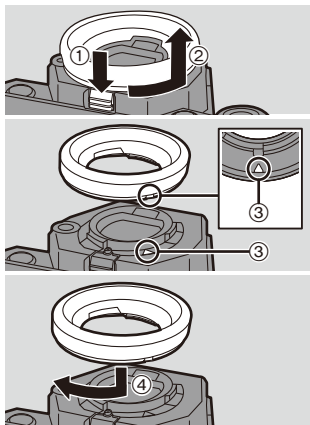

❖ Monitor/Viewfinder

- Do not push hard on the monitor.
This may cause irregular coloration or malfunction.
- If the camera gets cold in the cold place, the picture on the monitor/viewfinder will be slightly darker than usual at first when you turn the camera on.
When the interior of the camera warms up, this will return to normal brightness.
- Extremely high precision technology is employed to produce the Monitor/Viewfinder screen. However there may be some dark or bright spots (red, blue or green) on the screen. This is not a malfunction.
Though the Monitor/Viewfinder screen parts are produced with highly controlled precision technology, some pixels may be inactive or always lit.
The spots will not be recorded on images on a card.

❖ Lens

- Do not push hard on the lens surface.
- Do not aim the lens at the sun or strong light sources.
The concentrated light may cause fire or damage.
- Soiling on the lens surface (water, oil, fingerprints, etc.) may impact image quality.
Before and after use, lightly wipe the lens surface with a soft, dry cloth.
- When the camera is not being used, attach the lens cap and lens rear cap to prevent dust and dirt from adhering to or entering the camera.
- To protect the lens contact points (A), do not do the following.
These may cause a malfunction.
 - Touch the lens contact points.
 - Soil the lens contact points.
 - Place the lens with its mount surface facing down.
- To improve the dust and splash resistant performance of the interchangeable lens (S-R24105), a lens mount rubber is used in the mount.
 - The lens mount rubber will leave scuff marks on the digital camera mount, but this does not impact performance.
 - To replace the lens mount rubber, contact Panasonic.

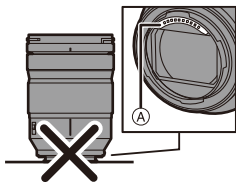

❖ Battery

The battery is a rechargeable lithium ion battery.

It is highly sensitive to temperature and humidity, and the effect on performance increases as the temperature rises or drops.

Always remove the battery after use.

- Place the removed battery in a plastic bag, and store or keep away from metallic objects (clips, etc.) for storage or transport.

If you drop the battery accidentally, check to see if the body of the battery and the contacts are deformed.

- Damage to the camera will result if a battery with deformed contacts is inserted into the camera.

Dispose of unusable battery.

- The battery has a limited life.
- Do not throw the battery into fire because it may cause an explosion.
- The unusable battery should be discarded in accordance with battery recycling laws. Call the RBRC hotline at 1-800-822-8837 for information.

Do not allow battery terminals to come into contact with metal objects (such as necklaces, hairpins, etc.).

- This can cause short-circuiting or heat generation and you may be badly burned if you touch a battery.

❖ Charger, AC Adaptor

- The [CHARGE] lamp may blink under the influence of static electricity or electromagnetic wave, depending on the charging environment. This phenomenon has no effects on charging.

- If you use the battery charger near a radio, the radio reception may be disturbed.

Keep the charger 1 m (3.3 feet) or more away from radio.

- During usage, the AC adaptor may emit an electrical hum; this is not a malfunction.
- After use, be sure to disconnect the power supply device from the electrical outlet. (A very small amount of current is consumed if it is left connected.)
- Keep the contacts (A) of the charger and battery clean. Wipe them with a dry cloth if they get dirty.

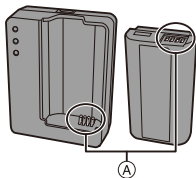

❖ Card

Do not leave the card in areas with high temperatures, direct sunlight, or areas prone to electromagnetic waves and static.

Do not bend or drop the card.

Do not subject the card to strong vibration.

- Otherwise, the card and recorded data may be damaged.
- Put the card in the card case or the storage bag after use and when storing or carrying the card.
- Do not allow dirt, water or other foreign objects to get into the contacts on the card. Additionally, do not touch the contacts with your hands.

Points to remember when disposing of/transferring the memory card

Format or delete using the camera or a PC will only modify the file management information, so it will not delete the data in the card completely.

We recommend physically destroying the card or using commercially available PC data deletion software to delete the card data completely when disposing of/transferring the card.

You are responsible for handling of data on cards.

❖ Personal information

Personal information is stored within the camera and in recorded images.

We recommend that you enhance security by setting a Wi-Fi password and Wi-Fi function lock to protect personal information. (→ [421](#), [422](#))

Disclaimer

- Information including personal information may be altered or vanish due to erroneous operation, effect of static electricity, accident, malfunction, repair, or other handlings.

Please note in advance that Panasonic is not liable in any way for any direct or indirect damage from the alteration or vanishing of information or personal information.

When requesting a repair or transferring/disposing of the camera

- After making a copy of personal information, be sure to delete information, including personal information, such as wireless LAN connection settings that you have registered or saved within the camera with [Reset]/[Delete account]. (→ 76 , 425)
- Reset the settings to protect the personal information. (→ 76)
- Remove the card from the camera.
- Settings may return to factory default when camera is repaired.
- Please contact the dealer where you purchased the camera or Panasonic if above operations are not possible due to malfunction.

When transferring/disposing of the card, refer to “Points to remember when disposing of/transferring the memory card” on page 476.

When uploading images to a web service

- Images may contain information that can be used to identify the user, such as recording dates and times, and location information.
Confirm details carefully before uploading images to a web service.

❖ When not using the camera for a long period of time

- Ensure you remove the battery and card from the camera.
When the battery is left inserted in the camera, a small amount of current will always flow even if the camera is turned off.
If the battery is left in the camera, it may over-discharge, and be rendered unusable even after charging.
- Store the battery in a cool and dry place with a relatively stable temperature.
(Recommended temperature: 15 °C to 25 °C (59 °F to 77 °F); recommended humidity: 40%RH to 60%RH)
- If storing for a long period of time, it is recommended that the battery be charged once per year, fully drained in the camera, then removed from the camera and then stored again.
- We recommend storing the camera with a desiccant (silica gel) when you keep it in a closet or a cabinet.
- Check all the parts before recording when you have not used the camera for a long period of time.

❖ Image Data

- Recorded data may be damaged or lost if the camera breaks down due to inappropriate handling.
Panasonic will not be liable for any damage caused due to loss of recorded data.

❖ Tripod

- Make sure the tripod is stable when the camera is attached to it.
- When using a tripod, removal of the battery may not be possible.
- Make sure that the screw on the tripod is not at an angle when attaching or removing the tripod.
Using excessive force may damage the camera tripod mount.
Also, care is required because tightening the screw excessively may damage the camera, or cause the rating label to come off.
- Please also refer to the operating instructions for the tripod.

❖ Shoulder Strap

- If you attach a heavy interchangeable lens to the camera body, do not carry the camera by the shoulder strap.
Hold the camera and the lens when carrying them.

❖ Wi-Fi Function

Use the camera as a wireless LAN device

When using devices or computer systems that require more reliable security than wireless LAN devices, ensure that the appropriate measures are taken for safety designs and defects for the systems used.
Panasonic will not take any responsibility for any damage that arises when using the camera for any purpose other than as a wireless LAN device.

Use of the Wi-Fi function of the camera is presumed to be in countries where it is sold

There is the risk that the camera violates the radio wave regulations if used in countries other than those where it is sold, and Panasonic takes no responsibility for any violations.

There is the risk that data sent and received via radio waves may be intercepted

Please note that there is the risk that data sent and received via radio waves may be intercepted by a third party.

Do not use the camera in areas with magnetic fields, static electricity or interference

- Do not use the camera in areas with magnetic fields, static electricity or interference, such as near microwave ovens.
These may cause the interruption of the radio waves.
- Using the camera near devices such as microwave ovens or cordless telephones that use the 2.4 GHz radio wave band may cause a decrease in performance in both devices.

Do not connect to the wireless network you are not authorized to use

When the camera utilizes its wireless LAN function, wireless networks will be searched automatically.

When this happens, wireless networks that you are not authorized to use (SSID*) may be displayed, however do not attempt to connect to the network as it may be considered as unauthorized access.

- * SSID refers to the name that is used to identify a network over a wireless LAN connection. If the SSID matches for both devices, transmission is possible.

Usage Duration, Number of Pictures

Listed below are the time lengths available for recording and the numbers of pictures that can be taken when the supplied battery is being used.

- The numbers of recordable pictures listed here are based on the CIPA (Camera & Imaging Products Association) standard.
- Using the XQD card from Sony.
(Using the SD card from Panasonic for the recordable time and actual recordable time for AVCHD)
- Using the interchangeable lens (S-R24105).
- The values listed are approximate.

❖ Recording Pictures (When Using the Monitor)

Number of recordable pictures	Approx. 360 pictures
--------------------------------------	-----------------------------

❖ Recording Pictures (When Using the Viewfinder)

The numbers in parentheses indicate the values that result when [Time to Sleep] in [Power Save LVF Shooting] is set to [1SEC] and the [Power Save LVF Shooting] function works as intended.

(Based on the test conditions derived from the CIPA standard and specified by Panasonic)

Number of recordable pictures	Approx. 340 pictures (Approx. 1100 pictures)
--------------------------------------	---

❖ Recording Videos (When Using the Monitor)

[AVCHD] (Recording with the recording quality set to [FHD/17M/60i])

Recordable time	Approx. 150 min
Actual recordable time	Approx. 75 min

[MP4] (Recording with the recording quality set to [FHD/28M/60p])

Recordable time	Approx. 140 min
Actual recordable time	Approx. 70 min

[MP4] (Recording with the recording quality set to [4K/LPCM/150M/60p])

Recordable time	Approx. 100 min
Actual recordable time	Approx. 50 min

- Actual recordable time is the time available for recording when repeating actions such as turning the camera on and off, starting/stopping recording, etc.

❖ Playback (When Using the Monitor)

Playback time	Approx. 270 min
----------------------	------------------------



- The operating times and number of recordable pictures will differ according to the environment and the operating conditions. For example, in the following case, the operating times shorten and the number of recordable pictures is reduced:
 - In low-temperature environments, such as on ski slopes.
- If the usage duration drops significantly even when the battery is fully charged, then the battery is at the end of its service life. Check the battery status, and replace with a new battery. (→ [356](#))

Number of Recordable Pictures, Recordable Time

Listed below are the numbers of pictures and the time lengths of videos that can be recorded on an XQD card and an SD card.

- The values listed are approximate.

❖ Number of Recordable Pictures

- [Aspect Ratio]: [3:2]; [Picture Quality]: [FINE]

[Picture Size]	XQD card capacity				SD card capacity		
	32 GB	64 GB	120 GB	240 GB	32 GB	64 GB	128 GB
[L] (46.5M)	1280	2480	4430	8730	1310	2640	5230
[M] (23.5M)	2440	4690	8380	16270	2500	4990	9880
[S] (12M)	4410	8450	15090	28620	4520	8980	17790
8K-Res.*	620	1210	2170	4300	640	1290	2560

- [Aspect Ratio]: [3:2]; [Picture Quality]: [RAW+FINE]

[Picture Size]	XQD card capacity				SD card capacity		
	32 GB	64 GB	120 GB	240 GB	32 GB	64 GB	128 GB
[L] (46.5M)	330	640	1150	2290	330	680	1350
[M] (23.5M)	370	730	1310	2600	380	780	1540
[S] (12M)	400	780	1410	2800	410	830	1660
8K-Res.*	260	500	900	1800	260	530	1060

- * Indicates the number of pictures when [L]-size JPEG images are recorded simultaneously with [HLG Photo] set to [8K-Res.].

❖ Available Recording Time (When Recording Videos)

- “h” is an abbreviation for hour, “m” for minute and “s” for second.
- The recordable time is the total time of all the videos which have been recorded.
- [Rec. File Format]: [AVCHD]

[Rec Quality]	SD card capacity		
	32 GB	64 GB	128 GB
[FHD/28M/60p]	2h30m	5h00m	10h00m
[FHD/17M/60i]	4h10m	8h15m	16h25m
[FHD/24M/30p] [FHD/24M/24p]	2h55m	5h50m	11h40m

• [Rec. File Format]: [MP4]

[Rec Quality]	XQD card capacity				SD card capacity		
	32 GB	64 GB	120 GB	240 GB	32 GB	64 GB	128 GB
[4K/LPCM/150M/60p]	27m00s	53m00s	1h35m	3h10m	27m00s	56m00s	1h50m
[4K/100M/30p] [4K/100M/24p]	40m00s	1h20m	2h20m	4h45m	41m00s	1h25m	2h45m
[FHD/28M/60p]	2h25m	4h45m	8h35m	17h10m	2h30m	5h00m	9h55m
[FHD/20M/30p]	3h15m	6h20m	11h25m	22h55m	3h20m	6h40m	13h15m









- Depending on the recording conditions and the type of card, the number of recordable pictures and available recording time vary.
- [9999+] is displayed on the recording screen if the remaining number of recordable pictures is 10000 or more.
The status LCD will display [9999].
- The continuous recordable time for videos is displayed on the screen.
- If the remaining recordable time is 60 minutes or more, then [59:59] will be displayed on the status LCD.













List of Default Settings/Saving Customization/Copied Settings











: Using [Reset], the function to return to default settings















: Using [Save to Custom Mode], the function to save settings details in the Custom mode













: Using [Save/Restore Camera Setting], the function to copy settings details





Menu		Default settings			
 [Photo]:  [Image Quality]					
[Photo Style]		[STD.]	✓	✓	✓
[Metering Mode]		[]	✓	✓	✓
[Aspect Ratio]		[3:2]	✓	✓	✓
[Picture Quality]		[FINE]	✓	✓	✓
[Picture Size]		[L] (46.5M)	✓	✓	✓
[HLG Photo]		[OFF]	✓	✓	✓
[High Resolution Mode]	[Start]	—			
	[Simul Record Normal Shot]	[ON]	✓	✓	✓
	[Shutter Delay]	[2 SEC]	✓	✓	✓
	[Motion Blur Processing]	[MODE1]	✓	✓	✓
[Long Exposure NR]		[ON]	✓	✓	✓
[ISO Sensitivity (photo)]	[ISO Auto Lower Limit Setting]	[100]	✓	✓	✓
	[ISO Auto Upper Limit Setting]	[AUTO]	✓	✓	✓
[Min. Shutter Speed]		[AUTO]	✓	✓	✓
[i.Dynamic Range]		[OFF]	✓	✓	✓
[Vignetting Comp.]		[ON]	✓	✓	✓
[Diffraction Compensation]		[OFF]	✓	✓	✓
[Filter Settings]	[Filter Effect]	[OFF]	✓	✓	✓
	[Simultaneous Record w/o Filter]	[OFF]	✓	✓	✓





















Menu		Default settings			
 [Photo]:  [Focus]					
[AF Custom Setting(Photo)]		[Set 1]	✓	✓	✓
[AF Assist Light]		[ON]	✓	✓	✓
[Focus Peaking]	[ON]/[OFF]	[ON]	✓	✓	✓
	[Focus Peaking Sensitivity]	—	✓	✓	✓
[1-Area AF Moving Speed]		[FAST]	✓	✓	✓
 [Photo]:  [Flash]					
[Flash Mode]			✓	✓	✓
[Firing Mode]		[TTL]	✓	✓	✓
[Flash Adjust.]		[±0 EV]	✓	✓	✓
[Flash Synchro]		[1ST]	✓	✓	✓
[Manual Flash Adjust.]		[1/1]	✓	✓	✓
[Auto Exposure Comp.]		[OFF]	✓	✓	✓
[Red-Eye Removal]		[OFF]	✓	✓	✓
[Wireless]		[OFF]	✓	✓	✓
[Wireless Channel]		[1CH]	✓	✓	✓
[Wireless FP]		[OFF]	✓	✓	✓
[Communication Light]		[HIGH]	✓	✓	✓
[Wireless Setup]		—	✓	✓	✓
 [Photo]:  [Others (Photo)]					
[Bracketing]	[Bracketing Type]	[OFF]	✓	✓	✓
	[More Settings]	—	✓	✓	✓
[Silent Mode]		[OFF]	✓	✓	✓
[Image Stabilizer]	[Operation Mode]		✓	✓	✓
	[Body(B.I.S.) / Lens(O.I.S.)]		✓	✓	✓
	[When to Activate]	[HALF-SHUTTER]	✓	✓	✓
	[E-Stabilization (Video)]	[OFF]	✓	✓	✓
	[Boost I.S. (Video)]	[OFF]	✓	✓	✓
	[Focal Length Set]	35.0 mm	✓	✓	✓

Menu		Default settings			
[Burst Shot 1 Setting]		[H]	✓	✓	✓
[Burst Shot 2 Setting]		[]	✓	✓	✓
[Shutter Type]		[MECH.]	✓	✓	✓
[Shutter Delay]		[OFF]	✓	✓	✓
[Ex. Tele Conv.]		[OFF]	✓	✓	✓
[Time Lapse/ Animation]	[Mode]	[Time Lapse Shot]	✓	✓	✓
	[Shooting Interval Setting]	[ON]	✓	✓	✓
	[Start Time]	[Now]	✓	✓	✓
	[Image Count]	1	✓	✓	✓
	[Shooting Interval]	1m00s	✓	✓	✓
	[Exposure Leveling]	[OFF]	✓	✓	✓
[Self Timer]		[ 10]	✓	✓	✓
[Flicker Decrease (Photo)]		[OFF]	✓	✓	✓
[6K/4K PHOTO]	[Picture Size / Burst Speed]	[6K 18M]	✓	✓	✓
	[Rec Method]	[]	✓	✓	✓
	[Pre-Burst Recording]	[OFF]	✓	✓	✓
[Post-Focus]		[OFF]	✓	✓	✓
[Multiple Exposure]	[Start]	—			
	[Auto Gain]	[ON]	✓	✓	✓
	[Overlay]	[OFF]	✓	✓	✓
 [Video]:  [Image Quality]					
[Exposure Mode]		[P]	✓	✓	✓
[Photo Style]		[ STD.]	✓	✓	✓
[Metering Mode]		[]	✓	✓	✓
[ISO Sensitivity (video)]	[ISO Auto Lower Limit Setting]	[100]	✓	✓	✓
	[ISO Auto Upper Limit Setting]	[AUTO]	✓	✓	✓
[Flicker Decrease (Video)]		[OFF]	✓	✓	✓
[i.Dynamic Range]		[OFF]	✓	✓	✓
[Vignetting Comp.]		[ON]	✓	✓	✓
[Diffraction Compensation]		[OFF]	✓	✓	✓









Menu		Default settings			
[Filter Settings]	[Filter Effect]	[OFF]	✓	✓	✓
	[Simultaneous Record w/o Filter]	[OFF]	✓	✓	✓
[Auto Exposure in P/A/S/M]		[ON]	✓	✓	✓
[CreativeVideo Combined Set.]	[F/SS/ISO/Exposure Comp.]	[]	✓	✓	✓
	[White Balance]	[]	✓	✓	✓
	[Photo Style]	[]	✓	✓	✓
	[Metering Mode]	[]	✓	✓	✓
	[AF Mode]	[]	✓	✓	✓
 [Video]:  [Image Format]					
[Rec Quality]		[FHD/28M/60p]	✓	✓	✓
[High Speed Video]		[OFF]	✓	✓	✓
[Rec. File Format]		[MP4]	✓	✓	✓
[Luminance Level]		[16-255]	✓	✓	✓
 [Video]:  [Focus]					
[AF Custom Setting(Video)]	[ON]/[OFF]	[OFF]	✓	✓	✓
	[SET]	—	✓	✓	✓
[Continuous AF]		[ON]	✓	✓	✓
[Focus Peaking]	[ON]/[OFF]	[ON]	✓	✓	✓
	[SET]	—	✓	✓	✓
[1-Area AF Moving Speed]		[FAST]	✓	✓	✓
 [Video]:  [Audio]					
[Sound Rec Level Disp.]		[OFF]	✓	✓	✓
[Sound Rec Level Adj.]		[0dB]	✓	✓	✓
[Sound Rec Level Limiter]		[ON]	✓	✓	✓
[Wind Noise Canceller]		[STANDARD]	✓	✓	✓
[Wind Cut]		[OFF]	✓	✓	✓
[Mic Socket]		[MIC ]	✓	✓	✓
[Special Mic.]		[STEREO]	✓	✓	✓
[XLR Mic Adaptor Setting]		[ON]	✓	✓	✓
[Sound Output]		[REALTIME]	✓	✓	✓















Menu		Default settings			
 [Video]:  [Monitor / Display]					
[HDMI Rec Output]	[Info Display]	[ON]	✓	✓	✓
 [Video]:  [Others (Video)]					
[Image Stabilizer]	[Operation Mode]	[]	✓	✓	✓
	[Body(B.I.S.) / Lens(O.I.S.)]	[]	✓	✓	✓
	[When to Activate]	[HALF-SHUTTER]	✓	✓	✓
	[E-Stabilization (Video)]	[OFF]	✓	✓	✓
	[Boost I.S. (Video)]	[OFF]	✓	✓	✓
	[Focal Length Set]	35.0 mm	✓	✓	✓
[Image Area of Video]		[FULL]	✓	✓	✓
 [Custom]:  [Image Quality]					
[Photo Style Settings]	[Show/Hide Photo Style]	—	✓	✓	✓
	[My Photo Style Settings]	—	✓	✓	✓
	[Reset Photo Style]	—			
[ISO Increments]		[1/3 EV]	✓	✓	✓
[Extended ISO]		[OFF]	✓	✓	✓
[Exposure Offset Adjust.]	[Multi Metering]	[±0 EV]	✓	✓	✓
	[Center Weighted]	[±0 EV]	✓	✓	✓
	[Spot]	[±0 EV]	✓	✓	✓
	[Highlight Weighted]	[±0 EV]	✓	✓	✓
[Color Space]		[sRGB]	✓	✓	✓
[Exposure Comp. Reset]		[OFF]	✓	✓	✓
 [Custom]:  [AF] [Focus/Shutter]					
[Focus/Shutter Priority]	[AFS]	[FOCUS]	✓	✓	✓
	[AFC]	[BALANCE]	✓	✓	✓
[Focus Switching for Vert / Hor]		[OFF]	✓	✓	✓
[AF/AE Lock Hold]		[OFF]	✓	✓	✓
[AF+MF]		[OFF]	✓	✓	✓









Menu		Default settings			
[MF Assist]	[Focus Ring]	[ON]	✓	✓	✓
	[AF Mode/MF]	[OFF]	✓	✓	✓
	[Press Joystick]	[OFF]	✓	✓	✓
	[MF Assist Display]	[PIP]	✓	✓	✓
[MF Guide]	[]	✓	✓	✓	
[Focus Ring Lock]	[OFF]	✓	✓	✓	
[Show/Hide AF Mode]	[Face/Eye/Body/Animal Detect.]	[ON]	✓	✓	✓
	[Tracking]	[ON]	✓	✓	✓
	[225-Area]	[ON]	✓	✓	✓
	[Zone (Vert./ Horz.)]	[ON]	✓	✓	✓
	[Zone (Square)]	[OFF]	✓	✓	✓
	[Zone (Oval)]	[ON]	✓	✓	✓
	[1-Area+]	[ON]	✓	✓	✓
	[Pinpoint]	[ON]	✓	✓	✓
	[Custom1]	[OFF]	✓	✓	✓
	[Custom2]	[OFF]	✓	✓	✓
[Custom3]	[OFF]	✓	✓	✓	
[Pinpoint AF Setting]	[Pinpoint AF Time]	[MID]	✓	✓	✓
	[Pinpoint AF Display]	[PIP]	✓	✓	✓
[AF-Point Scope Setting]	[Keep Enlarged Display]	[OFF]	✓	✓	✓
	[PIP Display]	[PIP]	✓	✓	✓
[Shutter AF]	[ON]	✓	✓	✓	
[Half-Press Shutter]	[OFF]	✓	✓	✓	
[Quick AF]	[OFF]	✓	✓	✓	
[Eye Sensor AF]	[OFF]	✓	✓	✓	
[Looped Focus Frame]	[OFF]	✓	✓	✓	
[AFC Start Point (225-Area)]	[OFF]	✓	✓	✓	















Menu		Default settings			
 [Custom]:  [Operation]					
[Q.MENU Settings]	[Layout Style]	[MODE1]	✓	✓	✓
	[Front Dial Assignment]	[Value]	✓	✓	✓
	[Item Customize (Photo)]	—	✓	✓	✓
	[Item Customize (Video)]	—	✓	✓	✓
[Touch Settings]	[Touch Screen]	[ON]	✓	✓	✓
	[Touch Tab]	[OFF]	✓	✓	✓
	[Touch AF]	[AF]	✓	✓	✓
	[Touch Pad AF]	[OFF]	✓	✓	✓
[Lock Lever Setting]	[Cursor]		✓	✓	✓
	[Joystick]		✓	✓	✓
	[Touch Screen]		✓	✓	✓
	[Dial]		✓	✓	✓
	[DISP. Button]		✓	✓	✓
[Fn Button Set]	[Setting in REC mode]	—	✓	✓	✓
	[Setting in PLAY mode]	—	✓	✓	✓
[Fn Lever Setting]	[Function of Fn Lever]	 [Silent Mode]	✓	✓	✓
	[MODE 2 Setting]	[ON]	✓	✓	✓
[WB/ISO/Expo. Button]		[AFTER PRESSING2]	✓	✓	✓
[ISO Displayed Setting]	[Front/Rear Dials]	[ / 	✓	✓	✓
[Exposure Comp. Disp. Setting]	[Cursor Buttons (Up/Down)]	[OFF]	✓	✓	✓
	[Front/Rear Dials]	[ / 	✓	✓	✓
[Dial Set.]	[Assign Dial (F/SS)]	[SET1]	✓	✓	✓
	[Rotation (F/SS)]	[ 	✓	✓	✓
	[Control Dial Assignment]	[	✓	✓	✓
	[Exposure Comp.]	[OFF]	✓	✓	✓
	[Dial Operation Switch Setup]	—	✓	✓	✓
	[Rotation (Menu Operation)]	[ 	✓	✓	✓

Menu		Default settings			
[Joystick Setting]		[D.FOCUS Movement]	✓	✓	✓
[Illuminated Button]		[ON2]	✓	✓	✓
[Video Rec. Button (Remote)]		[ON]	✓	✓	✓
 [Custom]:  [Monitor / Display]					
[Auto Review]	[Duration Time (photo)]	[OFF]	✓	✓	✓
	[Duration Time (6K/4K PHOTO)]	[HOLD]	✓	✓	✓
	[Duration Time (Post-Focus)]	[HOLD]	✓	✓	✓
	[Playback Operation Priority]	[OFF]	✓	✓	✓
[Constant Preview]	[ON]/[OFF]	[OFF]	✓	✓	✓
	[SET]	—	✓	✓	✓
[Level Gauge]		[ON]	✓	✓	✓
[Histogram]		[OFF]	✓	✓	✓
[Photo Grid Line]		[OFF]	✓	✓	✓
[Framing Outline]		[OFF]	✓	✓	✓
[Center Marker]		[OFF]	✓	✓	✓
[AF Area Display]		[ON]	✓	✓	✓
[Live View Boost]	[MODE1]/[MODE2]/[OFF]	[OFF]	✓	✓	✓
	[SET]	[M]	✓	✓	✓
[Monochrome Live View]		[OFF]	✓	✓	✓
[Night Mode]	[Monitor]	[OFF]	✓	✓	✓
	[LVF]	[OFF]	✓	✓	✓
[LVF/Monitor Disp. Set]	[LVF Disp. Set]		✓	✓	✓
	[Monitor Disp. Set]		✓	✓	✓
[Expo.Meter]		[OFF]	✓	✓	✓
[Focal Length]		[ON]	✓	✓	✓
[Photo/Video Preview]			✓	✓	✓
[Photos/Videos Remaining]			✓	✓	✓





Menu		Default settings			
[Show/Hide Monitor Layout]	[Control Panel]	[ON]	✓	✓	✓
	[Black Screen]	[ON]	✓	✓	✓
[Blinking Highlights]		[OFF]	✓	✓	✓
[Zebra Pattern]	[ZEBRA1]/[ZEBRA2]/ [OFF]	[OFF]	✓	✓	✓
	[SET]	—	✓	✓	✓
[HLG View Assist]	[Monitor]	[MODE2]	✓	✓	✓
	[HDMI]	[AUTO]	✓	✓	✓
[Sheer Overlay]	[ON]/[OFF]	[OFF]	✓		
	[SET]	—	✓		
[I.S. Status Scope]		[OFF]	✓	✓	✓
 [Custom]:  [Lens / Others]					
[Lens Focus Resume]		[OFF]	✓	✓	✓
[Focus Ring Control]	[NON-LINEAR]/[LINEAR]	[LINEAR]	✓	✓	✓
	[SET]	[150°]	✓	✓	✓
 [Setup]:  [Card/File]					
[Card Format]		—			
[Double Card Slot Function]	[Recording Method]		✓		✓
	[Destination Card Slot]	[1 → 2]	✓		✓
[Folder / File Settings]	[Select Folder]	—			
	[Create a New Folder]	—			
	[File Name Setting]	[Folder Number Link]	✓		✓
[File Number Reset]		—			
[Copyright Information]	[Artist]	[OFF]	✓		✓
	[Copyright Holder]	[OFF]	✓		✓
	[Display Copyright Info.]	—			





Menu		Default settings			
 [Setup]:  [Monitor / Display]					
[Power Save Mode]	[Sleep Mode]	[5MIN.]	✓		✓
	[Sleep Mode(Wi-Fi)]	[ON]	✓		✓
	[Auto LVF/Monitor Off]	[5MIN.]	✓		✓
	[Power Save LVF Shooting]	—	✓		✓
[Monitor Frame Rate]		[60fps]	✓		✓
[LVF Frame Rate]		[60fps]	✓		✓
[Monitor Settings]/[Viewfinder]		—	✓		
[Monitor Backlight]/[LVF Luminance]		[AUTO]	✓		✓
[Remaining Battery Level]			✓		✓
[Status-LCD]	[Backlight]	[H]	✓		✓
	[Display While Power Off]	[ON]	✓		✓
[Eye Sensor]	[Sensitivity]	[HIGH]	✓		✓
	[LVF/Monitor Switch]	[LVF/MON AUTO]	✓		✓
[Level Gauge Adjust.]	[Adjust.]	—	✓		
	[Level Gauge Value Reset]	—			
 [Setup]:  [IN/OUT]					
[Beep]	[Beep Volume]		✓		✓
	[AF Beep Volume]		✓		✓
	[AF Beep Tone]		✓		✓
	[E-Shutter Vol]		✓		✓
	[E-Shutter Tone]		✓		✓
[Headphone Volume]		[LEVEL3]	✓		✓
[Wi-Fi]		—	✓		
[Bluetooth]		—	✓		
[USB]	[USB Mode]	 [Select on connection]	✓		✓
	[USB Power Supply]	[ON]	✓		✓
[Battery Information]		—			
[Battery Use Priority]		[BG]	✓		✓



Menu		Default settings			
[TV Connection]	[HDMI Mode (Playback)]	[AUTO]	✓		✓
	[HLG View Assist (HDMI)]	[AUTO]	✓	✓	✓
	[VIERA Link (CEC)]	[OFF]	✓		✓
	[Background Color(Playback)]		✓		✓
 [Setup]:  [Setting]					
[Save to Custom Mode]		—	✓		✓
[Load Custom Mode]		—	✓		✓
[Custom Mode Settings]	[Limit No. of Custom Mode]	[3]	✓		✓
	[Edit Title]	—	✓		✓
	[How to Reload Custom Mode]	—	✓		✓
	[Select Loading Details]	—	✓		✓
[Save/Restore Camera Setting]		—			
[Reset]		—			
 [Setup]:  [Others]					
[Clock Set]		0:00:00 1/1/2019			
[Time Zone]		GMT -5:00			✓
[Pixel Refresh]		—			
[Sensor Cleaning]		—			
[Language]		—	✓		
[Firmware Version]		—			
[Online Manual]		—			
[Approved Regulations]		—			





Menu	Default settings			
 [My Menu]:  [Edit My Menu]				
[Add]	—			
[Sorting]	—			
[Delete]	—			
[Display from My Menu]	[OFF]	✓		✓
 [Playback] menu:  [Playback Mode]				
[Rotate Disp.]	[ON]	✓		✓
[Picture Sort]	[DATE/TIME]	✓		✓
[Magnify from AF Point]	[OFF]	✓		✓
[HLG View Assist (Monitor)]	[MODE2]	✓	✓	✓
 [Playback] menu:  [Process Image]				
[RAW Processing]	—			
[6K/4K PHOTO Bulk Saving]	—			
[6K/4K PHOTO Noise Reduction]	[AUTO]	✓		✓
[Time Lapse Video]	—			
[Stop Motion Video]	—			
 [Playback] menu:  [Add/Delete Info.]				
[Protect]	—			
[Rating]	—			
 [Playback] menu:  [Edit Image]				
[Resize]	—			
[Rotate]	—			
[Video Divide]	—			
[Copy]	—			
 [Playback] menu:  [Others]				
[Delete Confirmation]	["No" first]	✓		✓







List of Functions That Can Be Set in Each Recording Mode

Menu		iA	P	A	S	M	
 [Photo]:  [Image Quality]							
[Photo Style]		✓	✓	✓	✓	✓	
[Metering Mode]			✓	✓	✓	✓	
[Aspect Ratio]		✓	✓	✓	✓	✓	
[Picture Quality]		✓	✓	✓	✓	✓	
[Picture Size]		✓	✓	✓	✓	✓	
[HLG Photo]			✓	✓	✓	✓	
[High Resolution Mode]	[Start]		✓	✓	✓	✓	
	[Simul Record Normal Shot]		✓	✓	✓	✓	
	[Shutter Delay]		✓	✓	✓	✓	
	[Motion Blur Processing]		✓	✓	✓	✓	
[Long Exposure NR]			✓	✓	✓	✓	
[ISO Sensitivity (photo)]	[ISO Auto Lower Limit Setting]		✓	✓	✓	✓	
	[ISO Auto Upper Limit Setting]		✓	✓	✓	✓	
[Min. Shutter Speed]			✓	✓			
[i.Dynamic Range]			✓	✓	✓	✓	
[Vignetting Comp.]			✓	✓	✓	✓	
[Diffraction Compensation]			✓	✓	✓	✓	
[Filter Settings]	[Filter Effect]		✓	✓	✓	✓	
	[Simultaneous Record w/ o Filter]		✓	✓	✓	✓	
 [Photo]:  [Focus]							
[AF Custom Setting(Photo)]			✓	✓	✓	✓	
[AF Assist Light]			✓	✓	✓	✓	

Menu		iA	P	A	S	M	
[Focus Peaking]	[ON]/[OFF]	✓	✓	✓	✓	✓	
	[SET]	✓	✓	✓	✓	✓	
[1-Area AF Moving Speed]		✓	✓	✓	✓	✓	
 [Photo]:  [Flash]							
[Flash Mode]			✓	✓	✓	✓	
[Firing Mode]			✓	✓	✓	✓	
[Flash Adjust.]			✓	✓	✓	✓	
[Flash Synchro]			✓	✓	✓	✓	
[Manual Flash Adjust.]			✓	✓	✓	✓	
[Auto Exposure Comp.]			✓	✓	✓	✓	
[Red-Eye Removal]			✓	✓	✓	✓	
[Wireless]			✓	✓	✓	✓	
[Wireless Channel]			✓	✓	✓	✓	
[Wireless FP]			✓	✓	✓	✓	
[Communication Light]			✓	✓	✓	✓	
[Wireless Setup]			✓	✓	✓	✓	
 [Photo]:  [Others (Photo)]							
[Bracketing]	[Bracketing Type]	✓	✓	✓	✓	✓	
	[More Settings]	✓	✓	✓	✓	✓	
[Silent Mode]		✓	✓	✓	✓	✓	
[Image Stabilizer]	[Operation Mode]	✓	✓	✓	✓	✓	
	[Body(B.I.S.) / Lens(O.I.S.)]	✓	✓	✓	✓	✓	
	[When to Activate]	✓	✓	✓	✓	✓	
	[E-Stabilization (Video)]	✓	✓	✓	✓	✓	
	[Boost I.S. (Video)]	✓	✓	✓	✓	✓	
[Focal Length Set]		✓	✓	✓	✓	✓	

Menu		iA	P	A	S	M	
[Burst Shot 1 Setting]		✓	✓	✓	✓	✓	
[Burst Shot 2 Setting]		✓	✓	✓	✓	✓	
[Shutter Type]		✓	✓	✓	✓	✓	
[Shutter Delay]		✓	✓	✓	✓	✓	
[Ex. Tele Conv.]		✓	✓	✓	✓	✓	
[Time Lapse/Animation]		✓	✓	✓	✓	✓	
[Self Timer]		✓	✓	✓	✓	✓	
[Flicker Decrease (Photo)]		✓	✓	✓	✓	✓	
[6K/4K PHOTO]	[Picture Size / Burst Speed]	✓	✓	✓	✓	✓	
	[Rec Method]	✓	✓	✓	✓	✓	
	[Pre-Burst Recording]	✓	✓	✓	✓	✓	
[Post-Focus]		✓	✓	✓	✓	✓	
[Multiple Exposure]	[Start]		✓	✓	✓	✓	
	[Auto Gain]		✓	✓	✓	✓	
	[Overlay]		✓	✓	✓	✓	
 [Video]:  [Image Quality]							
[Exposure Mode]							✓
[Photo Style]		✓	✓	✓	✓	✓	✓
[Metering Mode]			✓	✓	✓	✓	✓
[ISO Sensitivity (video)]	[ISO Auto Lower Limit Setting]						✓
	[ISO Auto Upper Limit Setting]						✓
[Flicker Decrease (Video)]			✓	✓	✓	✓	
[i.Dynamic Range]			✓	✓	✓	✓	✓

Menu		iA	P	A	S	M	
[Vignetting Comp.]			✓	✓	✓	✓	✓
[Diffraction Compensation]			✓	✓	✓	✓	✓
[Filter Settings]	[Filter Effect]		✓	✓	✓	✓	✓
	[Simultaneous Record w/ o Filter]		✓	✓	✓	✓	
[Auto Exposure in P/A/S/M]			✓	✓	✓	✓	✓
[CreativeVideo Combined Set.]	[F/SS/ISO/Exposure Comp.]		✓	✓	✓	✓	✓
	[White Balance]		✓	✓	✓	✓	✓
	[Photo Style]		✓	✓	✓	✓	✓
	[Metering Mode]		✓	✓	✓	✓	✓
	[AF Mode]		✓	✓	✓	✓	✓
 [Video]:  [Image Format]							
[Rec Quality]		✓	✓	✓	✓	✓	✓
[High Speed Video]							✓
[Rec. File Format]		✓	✓	✓	✓	✓	✓
[Luminance Level]		✓	✓	✓	✓	✓	✓
 [Video]:  [Focus]							
[AF Custom Setting(Video)]	[ON]/[OFF]	✓	✓	✓	✓	✓	✓
	[SET]	✓	✓	✓	✓	✓	✓
[Continuous AF]		✓	✓	✓	✓	✓	✓
[Focus Peaking]	[ON]/[OFF]	✓	✓	✓	✓	✓	✓
	[SET]	✓	✓	✓	✓	✓	✓
[1-Area AF Moving Speed]		✓	✓	✓	✓	✓	✓

Menu		iA	P	A	S	M	
 [Video]:  [Audio]							
	[Sound Rec Level Disp.]	✓	✓	✓	✓	✓	✓
	[Sound Rec Level Adj.]	✓	✓	✓	✓	✓	✓
	[Sound Rec Level Limiter]	✓	✓	✓	✓	✓	✓
	[Wind Noise Canceller]	✓	✓	✓	✓	✓	✓
	[Wind Cut]	✓	✓	✓	✓	✓	✓
	[Mic Socket]	✓	✓	✓	✓	✓	✓
	[Special Mic.]	✓	✓	✓	✓	✓	✓
	[XLR Mic Adaptor Setting]	✓	✓	✓	✓	✓	✓
	[Sound Output]	✓	✓	✓	✓	✓	✓
 [Video]:  [Monitor / Display]							
[HDMI Rec Output]	[Info Display]	✓	✓	✓	✓	✓	✓
 [Video]:  [Others (Video)]							
[Image Stabilizer]	[Operation Mode]	✓	✓	✓	✓	✓	✓
	[Body(B.I.S.) / Lens(O.I.S.)]	✓	✓	✓	✓	✓	✓
	[When to Activate]	✓	✓	✓	✓	✓	
	[E-Stabilization (Video)]	✓	✓	✓	✓	✓	✓
	[Boost I.S. (Video)]	✓	✓	✓	✓	✓	✓
	[Focal Length Set]	✓	✓	✓	✓	✓	✓
	[Image Area of Video]	✓	✓	✓	✓	✓	✓

Specifications

The specifications are subject to change for performance enhancement.

Digital camera body (DC-S1R):

Information for your safety

Power source:	9.0 V ===
Power consumption:	6.6 W (when recording with the monitor) (When using the interchangeable lens (S-R24105)) 4.6 W (when playing back with the monitor) (When using the interchangeable lens (S-R24105))

Type	
Type	Digital Single Lens Mirrorless camera
Recording media	Card slot 1: XQD memory card Card slot 2: SD memory card / SDHC memory card* / SDXC memory card* * Compliant with UHS-I/UHS-II UHS Speed Class 3, UHS-II Video Speed Class 90 Double slot recording function is available.
Lens mount	Leica Camera AG L-Mount
Image sensor	
Image sensor	35 mm full-frame (36.0 mm×24.0 mm) CMOS sensor, a total of 50,440,000 pixels, primary color filter
Camera effective pixels	47,300,000 pixels

Recording format for still images	
File format for still images	JPEG (DCF compliant, Exif 2.31 compliant) / RAW / HLG photo (CTA-2072 compliant)
File format for 6K/4K photos	6K photo: MP4 (H.265/HEVC, AAC (2ch)) 4K photo: MP4 (H.264/MPEG-4 AVC, AAC (2ch))
Picture size (pixels)	<p>When the aspect ratio setting is [4:3] 7440×5584 (L) / 5296×3968 (M) / 3792×2848 (S) / 14880×11168 ([High Resolution Mode]) / 4992×3744 (6K photo) / 3328×2496 (4K photo) / 5760×4320 ([HLG Photo]/[8K-Res.]) / 2880×2160 ([HLG Photo]/[4K-Res.])</p> <p>When the aspect ratio setting is [3:2] 8368×5584 (L) / 5952×3968 (M) / 4272×2848 (S) / 16736×11168 ([High Resolution Mode]) / 5184×3456 (6K photo) / 3504×2336 (4K photo) / 6464×4320 ([HLG Photo]/[8K-Res.]) / 3232×2160 ([HLG Photo]/[4K-Res.])</p> <p>When the aspect ratio setting is [16:9] 8368×4712 (L) / 5952×3352 (M) / 4272×2400 (S) / 16736×9424 ([High Resolution Mode]) / 3840×2160 (4K photo) / 7680×4320 ([HLG Photo]/[8K-Res.]) / 3840×2160 ([HLG Photo]/[4K-Res.])</p> <p>When the aspect ratio setting is [1:1] 5584×5584 (L) / 3968×3968 (M) / 2848×2848 (S) / 11168×11168 ([High Resolution Mode]) / 2880×2880 (4K photo) / 4320×4320 ([HLG Photo]/[8K-Res.]) / 2144×2144 ([HLG Photo]/[4K-Res.])</p> <p>When the aspect ratio setting is [65:24] 8368×3088 (L)</p> <p>When the aspect ratio setting is [2:1] 8368×4184 (L)</p>
Image quality for pictures	Fine / Standard / RAW+Fine / RAW+Standard / RAW

Recording format for video		
Video format	AVCHD Progressive / AVCHD / MP4	
Audio format	AVCHD	Dolby Audio™ (2ch)
	MP4	AAC (2ch), LPCM (2ch, 48 kHz/16 bit)
Image quality for videos	<p>[Rec. File Format]: [AVCHD], [MP4]</p> <p>Refer to page 234 of this document for details.</p> <p>Refer to page 247 of this document for details about High Speed Video.</p>	
Viewfinder / Monitor		
Viewfinder	<p>OLED Live Viewfinder (4:3) (approx. 5,760,000 dots) (a field of view ratio of approx. 100%)</p> <p>(Magnification approx 0.78×, with 50 mm lens at infinity; -1.0 m^{-1}, when the aspect ratio is set to [3:2]) (with diopter adjustment -4.0 to $+2.0$ diopter)</p>	
Monitor	<p>3.2" TFT LCD (3:2) (approx. 2,100,000 dots) (a field of view ratio of approx. 100%), touch screen</p>	
Focus		
Auto focus type	TTL type based on image detection (Contrast AF)	
Focus mode	AFS / AFC / MF	
AF mode	<p>Automatic detection (Face/Eye/Body/Animal) / Tracking / 225-Area / Zone (Vertical/Horizontal) / Zone (Square) / Zone (Oval) / 1-Area+Supplementary / 1-Area / Pinpoint / Custom1, 2, 3 (Focus area selection is possible by touching or with the joystick)</p>	

Exposure control	
Light metering system, Light metering mode	1728-zone metering, multi-metering / center-weighted metering / spot metering / highlight-weighted metering
Metering range	EV 0 to EV 18
Exposure	Program AE, Aperture-Priority AE, Shutter-Priority AE, Manual Exposure
Exposure compensation	1/3 EV steps, ± 5 EV
ISO sensitivity (standard output sensitivity)	1/3 EV steps, AUTO / 100 to 25600 When [Extended ISO] is set: AUTO / 50 to 51200
Image stabilizer	
Image stabilizer type	Compliant with Image sensor shift type, 5-axis stabilizer, Dual I.S.2
Image stabilizer effect	6.0 stops Based on the CIPA standard (Yaw/Pitch direction: focal length $f=105$ mm) (When using the interchangeable lens (S-R24105))
White balance	
White balance mode	AWB / AWBc / AWBw / Daylight / Cloudy / Shade / Incandescent lights / Flash / White Set 1, 2, 3, 4 / Color temperature 1, 2, 3, 4
Shutter	
Shutter type	Focal-plane shutter
Shutter speed	Pictures: B (Bulb) (max. approx. 30 minutes), 60 seconds to 1/8000 of a second (mechanical shutter) B (Bulb) (max. approx. 30 minutes), 60 seconds to 1/2000 of a second (electronic front curtain) B (Bulb) (max. approx. 60 seconds), 60 seconds to 1/16000 of a second (electronic shutter) Videos: 1/25 of a second to 1/16000 of a second

Burst recording	
Mechanical shutter/ Electronic front curtain	9 frames/second (high speed, AFS/MF), 6 frames/second (high speed, AFC), 5 frames/second (medium speed), 2 frames/second (low speed)
Electronic shutter	9 frames/second (high speed, AFS/MF), 5 frames/second (high speed, AFC), 5 frames/second (medium speed), 2 frames/second (low speed)
Number of burst picture frames	[FINE] / [STD.]: 50 frames or more [RAW+FINE] / [RAW+STD.]: 35 frames or more [RAW]: 40 frames or more When recording is performed under the test conditions specified by Panasonic
Minimum illumination	
Approx. 6 lx (when the shutter speed is 1/30 of a second) (When using the interchangeable lens (S-R24105))	
Flash (when using an external flash)	
Flash mode	Auto / Auto/Red-Eye / Forced Flash On / Forced On/Red-Eye / Slow Sync. / Slow Sync./Red-Eye / Forced Flash Off
Flash synchronization speed	Equal to or smaller than 1/320 of a second (The guide number decreases at 1/320 of a second, only during [S]/[M] modes)
Zoom	
Extended Tele Conversion (Picture)	Max. 2× (when a picture size of [S] is selected.)
Microphone / Speaker	
Microphone	Stereo
Speaker	Monaural
Language select	
[ENGLISH] / [DEUTSCH] / [FRANÇAIS] / [ITALIANO] / [ESPAÑOL] / [繁體中文] / [PORTUGUÊS] / [日本語]	

Interface	
USB	SuperSpeed USB3.1 GEN1 Type C Supports USB Power Delivery (9.0 V/3.0 A)
HDMI	HDMI Type A
[REMOTE]	∅ 2.5 mm jack
[MIC]	∅ 3.5 mm jack
Headphones	∅ 3.5 mm jack
Flash Synchro	Yes
Splash Resistant	
Yes	
Dimensions / Mass	
Dimensions	Approx. 148.9 mm (W)×110.0 mm (H)×96.7 mm (D) (5.86" (W)×4.33" (H)×3.81" (D)) (excluding the projecting parts)
Mass (Weight)	Approx. 1020 g/2.25 lb (with one XQD memory card and the battery) Approx. 898 g/1.98 lb (camera body)
Operating environment	
Recommended operating temperature	−10 °C* to 40 °C (14 °F to 104 °F) * The performance of the battery (number of recordable pictures/operating time) may decrease temporarily when using in a temperature between −10 °C and 0 °C (14 °F and 32 °F) (cold places such as ski resorts or places at high altitude).
Permissible relative humidity	10%RH to 80%RH

35 mm full-frame interchangeable lens: S-R24105 “LUMIX S 24-105 mm F4 MACRO O.I.S.”

Mount	Leica Camera AG L-Mount
Focal length	f=24 mm to 105 mm
Lens construction	16 elements in 13 groups (2 aspherical ED lenses, 2 aspherical lenses, 1 UED lens, 2 ED lenses)
Aperture type	9 diaphragm blades/Circular aperture diaphragm
Maximum aperture	F4.0
Minimum aperture value	F22
Angle of view	84° (Wide) to 23° (Tele)
Recording range	0.30 m (0.98 feet) to ∞ (from the focus distance reference line)
Maximum image magnification	0.5×
Image stabilizer	Yes
Filter diameter	77 mm
Maximum diameter	∅84 mm (3.3")
Overall length	Approx. 118 mm (4.6") (from the tip of the lens to the base side of the lens mount)
Mass (Weight)	Approx. 680 g (1.4991 lb)
Dust and splash resistant	Yes
Recommended operating temperature	-10 °C to 40 °C (14 °F to 104 °F)
Permissible relative humidity	10%RH to 80%RH

Index

Numerics

1 Shot "6K/4K PHOTO"	283
1 Shot RAW+JPG	283
1 Shot Spot Metering	283
1-Area (AF)	107
1-area AF moving speed	311
1-Area+ (AF)	107
225-Area (AF)	104
6K/4K Burst	131
6K/4K Burst (S/S)	132
6K/4K burst file	138
6K/4K PHOTO	130
6K/4K PHOTO Bulk Saving	144
6K/4K PHOTO Noise Reduction	140
6K/4K Photo Play	285
6K/4K Pre-Burst	132

A

AC adaptor	447, 475
AF	92
AF area display	341
AF assist lamp	309
AF Custom Setting (Photo)	96
AF Custom Setting (Video)	240
AF mode	98
AF ON	94, 119
AF Tracking	79, 102
AF/AE lock	191
AF/AE lock hold	329
AF+AE	114
AF+MF	329
AFC	91
AFC Start Point (225-Area)	104
AF-Point Scope	94
AF-Point Scope setting	332

AFS	91
Aperture Bracket	158
Aperture-Priority AE mode	181
Approved Regulations	360
Aspect Ratio	82
Auto Clock Set	394
Auto Exposure Comp.	225
Auto exposure in P/A/S/M	321
Auto focus	92
Auto LVF/Monitor Off	44
Auto Review	338
Auto Transfer	390
Auto White Balance	195
Automatic scene detection	78
Available recording time (for video recording)	481, 483
AVCHD	233
AVCHD Progressive	234

B

Backlight compensation	78
Battery	33, 36, 475
Battery Grip	445
Battery indication	352
Battery information	356
Battery Use Priority	445
Beep	354
Blinking highlights	345
Bluetooth (menu)	354, 374
Boost I.S. (Video)	176
Bracket	155
Bulb	187, 387
Burst Rate	127
Burst Shot	126
Burst Shot 1 Setting	126, 130
Burst Shot 2 Setting	126, 130

C

Cable holder.....	249
Calendar screen.....	267
Card.....	22, 46, 87, 476
Card Slot Change.....	284, 294
Center marker.....	341
Center-weighted metering.....	178
Charge.....	33
Cleaning.....	472
Clock Set.....	53
Cloud Limit.....	419
Cloud sync service.....	410
Color space.....	328, 435
Color Tone.....	201
Communication Light.....	229
Compression rate.....	85, 305
Condensation.....	18
Constant preview.....	339
Continuous AF (Video).....	239
Contrast.....	201
Control dial.....	63
Control panel.....	68, 451
Copy.....	367
Copyright information.....	350
Creating a picture from a video.....	263
Creative video combined set.....	246
Creative Video mode.....	244
Custom (AF).....	110
Custom menu.....	325
Custom mode.....	296
Custom Mode Settings.....	297

D

Date printing.....	443
DC coupler.....	447
DCF standard.....	260
Delete.....	269

Delete confirmation.....	368
Delete Location Data.....	419
Delete Single.....	269
Destination Card Slot.....	283
Device Name.....	421
Dial operation switch setup.....	289
Dial setting.....	336, 337
Diffraction compensation.....	308
Diopter adjustment.....	66
Double Card Slot Function.....	87
Drive mode.....	125
Dust reduction function.....	472

E

Electronic Front Curtain.....	170
Electronic Shutter.....	170
Enlarged display.....	264
Entering characters.....	369
E-Stabilization (Video).....	174
Exposure Bracket.....	158
Exposure compensation.....	189
Exposure compensation display setting.....	335
Exposure compensation reset.....	328
Exposure meter.....	344
Exposure Mode.....	244
Exposure offset adjustment.....	328
Extended ISO.....	327
Extended Tele Conversion.....	122
External flash.....	216
External microphone.....	253
External Monitor/Recorder.....	248
Eye cup.....	473
Eye sensor.....	353
Eye sensor AF.....	332

F

Face/Eye/Body/Animal Detect.....	79, 99
File number.....	88, 435, 453, 455
File Number Reset.....	90
Filter Effect.....	204
Filter Settings.....	204
Firing Mode.....	219
Firmware update.....	17, 360
Flash.....	216
Flash Adjust.....	224
Flash mode.....	220
Flash Synchro.....	223
Flash synchro socket.....	217
Flicker decrease (photo).....	315
Flicker decrease (video).....	320
Fn button.....	278
Fn Button Set.....	279
Fn lever.....	286
Fn Lever Setting.....	286
Focal length.....	344
Focus.....	92, 239
Focus Area Set.....	283
Focus Bracket.....	159
Focus mode.....	91
Focus peaking.....	310
Focus ring control.....	348
Focus ring lock.....	330
Focus Stacking.....	166
Focus Switching for Vert/Hor.....	116
Focus/shutter priority.....	329
Folder number.....	88, 90, 435, 453, 455
Folder/File Settings.....	88
Forced flash off.....	221
Format.....	48
Framing outline.....	341
Front dial.....	63

G

Gamma setting (Photo Style).....	199
Group image.....	268

H

Half-press shutter.....	332
HDAVI Control™.....	428
HDMI cable.....	248, 426, 428
HDMI mode (play).....	357
HDMI Rec Output.....	252
Headphone Volume.....	258
High Resolution mode.....	210
High Speed Video.....	247
Highlight.....	201
Highlight-weighted metering.....	178
Histogram.....	340
HLG photo.....	214
HLG view assist.....	347
Hot shoe cover.....	216
Hue.....	201

I

i.Dynamic range.....	307
I.S. status scope.....	348
Illuminated button.....	337
Image area of video.....	238
Image Quality.....	201
Image stabilizer.....	172
Info Display (During HDMI Output)....	252
Intelligent Auto mode.....	77
iOS.....	373
ISO displayed setting.....	335
ISO increments.....	327
ISO sensitivity.....	192
ISO sensitivity (photo).....	306
ISO sensitivity (video).....	319

J	
Joystick	64
Joystick setting	337
K	
Knee	241
L	
Lens	21, 49, 474
Lens focus resume	348
Lens hood	51
Level gauge	339
Level gauge adjustment	353
Live view boost	342
Load Custom Mode	299
Location logging	392
Lock lever setting	334
Long exposure NR	306
Looped focus frame	333
Low illumination AF	93
Luminance Level	241
LUMIX CLUB	422
LUMIX Sync	373
LUMIX Tether	438
LVF frame rate	351
LVF Luminance	352
LVF/Monitor Disp. Style	283
LVF/monitor display set	343
LVF/monitor switch	353
M	
Magnify from AF point	363
Manual Exposure mode	185
Manual Flash Adjust.	220, 228
Manual focus	117
Mechanical Shutter	170
Metering mode	178
MF	117
MF Assist	330
MF Assist display	330
MF Guide	330
Mic Socket	253
Minimum shutter speed	307
Monitor	58, 448
Monitor backlight	352
Monitor frame rate	351
Monitor settings	352
Monochrome live view	342
MP4	233
Multi-metering	178
Multiple exposure	316
My Menu	300
N	
Network Address	422
Night mode	343
Number of pictures that can be taken continuously	128
Number of prints	443
Number of recordable pictures	480, 482
O	
One Push AE	283
Online Manual	360
Operation lock lever	65
Optical zoom	121
P	
Page Layout	443
Paper Size	443
PC connection	402, 421, 430, 438
Photo grid line	341
Photo Style	199
Photo style settings	327

Photo/video preview	344	Recording distance reference	120
PHOTOfunSTUDIO	431	Recording videos	230
Photos/videos remaining	345	Recording with Time Lapse Shot	145
PictBridge	442	Red-eye removal	225
Picture Quality	85	Reduce Rolling Shutter	140
Picture Size	83	Register to Favorite (Wi-Fi connection)	417
Picture sort	363	Remote operation	384
Pinpoint (AF)	108	Remote Shooting & View	372
Pinpoint AF setting	331	Remote Wakeup	393
Pixel refresh	359	Reset	76
Play back	259	Resize	366
Play back video	261	Restore to Default	282, 284, 287
Playback menu	361	Returning from Sleep Mode	387
Post-Focus	161	Rotate	366
Post-Recording Refinement	140	Rotate display	363
Power Save LVF Shooting	44		
Power Save Mode	44	S	
Pre-Burst recording	134	Saturation	201
Preview	188	Save to Custom Mode	296
Print	441	Save/Restore Camera Setting	302
Program AE mode	179	SD card	22
Program Shift	180	SD Speed Class	23
Protect	365	Self-timer	153
		Send Image (smartphone)	399, 401
Q		Sending file format	419
Q.MENU Settings	291	Sending size	419
Quick AF	332	Sensor cleaning	359
Quick menu	71, 291	Setup menu	349
		Shadow	201
R		Sheer overlay	347
Rating	365	Shoulder strap	31
RAW	85	Show/hide AF mode	331
RAW Processing	271	Show/hide monitor layout	345
Rear dial	63	Shutter AF	332
Rec Quality	234	Shutter delay	314
Rec. File Format	233	Shutter Remote Control	386, 446
Rec/Playback Switch	283, 285		

Shutter type.....	170
Shutter-Priority AE mode	183
Silent mode	169
Simultaneous Record w/o Filter	209
Sleep Mode.....	44
Sleep Mode (Wi-Fi).....	44
Sound Output.....	258
Sound Rec Level Adj.	243
Sound Rec Level Disp.	243
Sound Rec Level Limiter.....	243
Special Mic.....	254
Spot metering.....	178
Starlight AF	93
Status LCD.....	30, 353
Status LCD backlight	70, 353
Stereo Shotgun Microphone	253
Stop Motion Animation	148
Stop motion video	364
Storage (recorder).....	436

T

Thumbnail screen	266
Time lapse video.....	364
Time zone	359
Touch AE	81
Touch AF	114, 333
Touch Pad AF	115, 333
Touch screen	64
Touch Settings	333
Touch Shutter	80
Touch tab.....	333
Touch Zoom.....	123
Tripod.....	478
TTL.....	219, 224, 311
TV connection	357
TV Playback.....	426

U

UHS Speed Class	23
USB connection cable	34, 38, 40, 433, 436, 439, 441
USB mode.....	355
USB PD (USB Power Delivery)	40
USB power supply.....	355

V

V.MODE button	66
Version display	360
Vertical orientation detection function.....	57
Video Divide	276
Video menu	318
Video rec. button	60, 230
Video Rec. Button (Remote)	446
Video Speed Class.....	23
VIERA Link (CEC).....	357, 428
Viewfinder.....	66, 352, 448
Vignetting compensation	308

W

WB/ISO/Exposure button	335
Web service.....	407
White balance.....	194
White Balance Adjustment	197
White Balance Bracket.....	160
White Balance Bracket (Color Temperature).....	160
Wi-Fi function	370
Wi-Fi function lock.....	422
Wi-Fi network settings.....	354
Wi-Fi password.....	421
Wi-Fi setup menu	421
Wind Cut.....	255
Wind noise canceler	323

Wireless	227
Wireless Channel	227
Wireless flash	226
Wireless FP	229
Wireless icon	370
Wireless printing	405
Wireless Setup	228
WPS	413, 416

X

XLR Microphone Adaptor	256
XQD card	22

Z

Zebra pattern	346
Zoom	121

Trademarks and Licences



- L-Mount is a trademark or registered trademark of Leica Camera AG.
- XQD is a trademark of Sony Corporation.
- SDXC Logo is a trademark of SD-3C, LLC.
- The terms HDMI and HDMI High-Definition Multimedia Interface, and the HDMI Logo are trademarks or registered trademarks of HDMI Licensing Administrator, Inc. in the United States and other countries.
- The USB Type-C™ Charging Trident Logos are trademarks of USB Implementers Forum, Inc.
- The SuperSpeed USB Trident Logo is a registered trademark of USB Implementers Forum, Inc.
- “AVCHD”, “AVCHD Progressive” and the “AVCHD Progressive” logo are trademarks of Panasonic Corporation and Sony Corporation.
- Dolby, Dolby Audio, and the double-D symbol are trademarks of Dolby Laboratories.
- HDAVI Control™ is a trademark of Panasonic Corporation.
- Adobe is a trademark or registered trademark of Adobe Systems Incorporated in the United States and/or other countries.
- Pentium is a trademark of Intel Corporation in the U.S. and/or other countries.
- Windows is a registered trademark or trademark of Microsoft Corporation in the United States and/or other countries.
- iMovie, Mac, OS X and macOS are trademarks of Apple Inc., registered in the U.S. and other countries.
- App Store is a service mark of Apple Inc.
- Android and Google Play are trademarks or registered trademarks of Google LLC.



- The Bluetooth® word mark and logos are registered trademarks owned by Bluetooth SIG, Inc. and any use of such marks by Panasonic Corporation is under license. Other trademarks and trade names are those of their respective owners.
- The Wi-Fi CERTIFIED™ Logo is a certification mark of Wi-Fi Alliance®.
- The Wi-Fi Protected Setup™ Logo is a certification mark of Wi-Fi Alliance®.
- “Wi-Fi®” is a registered trademarks of Wi-Fi Alliance®.
- “Wi-Fi Protected Setup™”, “WPA™”, and “WPA2™” are trademarks of Wi-Fi Alliance®.
- This product uses “DynaFont” from DynaComware Corporation. DynaFont is a registered trademark of DynaComware Taiwan Inc.
- QR Code is a registered trademark of DENSO WAVE INCORPORATED.
- Other names of systems and products mentioned in these instructions are usually the registered trademarks or trademarks of the manufacturers who developed the system or product concerned.

This product is licensed under the AVC Patent Portfolio License for the personal use of a consumer or other uses in which it does not receive remuneration to (i) encode video in compliance with the AVC Standard ("AVC Video") and/or (ii) decode AVC Video that was encoded by a consumer engaged in a personal activity and/or was obtained from a video provider licensed to provide AVC Video. No license is granted or shall be implied for any other use. Additional information may be obtained from MPEG LA, L.L.C.

See <http://www.mpegla.com>

Firmware Update

LUMIX

S1R

❖ Firmware Has Been Updated

A firmware update has been made available to improve camera capabilities and to add functionality.

The subsequent sections describe functions that have been added or modified. Also refer to the “Owner’s Manual”.

- To check the firmware version of the camera, select [Firmware Version] in the [Setup] ([Others]) menu.
- For the latest information on the firmware or to download/update the firmware, visit the following support site:

<https://panasonic.jp/support/global/cs/dsc/>

(English only)



Click here to move to the cover page of the “Owner’s Manual”.

Contents

Before Use	F-4
About Applications/Software	F-4
Firmware Ver. 1.2	F-5
Improved Image Stabilizer Performance	F-5
[AF-ON : Near Shift]/[AF-ON : Far Shift].....	F-6
Firmware Ver. 1.3	F-7
Support for CFexpress Cards	F-7
Number of Recordable Pictures, Recordable Time (CFexpress Card)	F-10
Improved Compatibility with Interchangeable Lenses	F-12
Changes to the Operation of the Image Stabilizer When Using Other Manufacturer's Lenses	F-12
[Lens Fn Button Setting] Has Been Added.....	F-13
Changes to the AF Function	F-14
Support for [AF+MF] in AFC.....	F-14
[MODE2] Has Been Added to [Continuous AF].....	F-14
Support for Exposure Operations During [High Speed Video] Recording	F-15
Additions/Changes to Other Functions	F-16
[Destination Card Slot] Has Been Added to the [RAW Processing] Setting Items	F-16
[0.5SEC] Has Been Added to the [Duration Time (photo)] of [Auto Review]	F-17
Support for [Forced Flash Off] in [iA] Mode.....	F-17
[AF Assist Light] Has Been Added to the [Video] Menu	F-17
[Off (Disable Press and Hold)] Has Been Added to [Fn Button Set]	F-18
[Preview Aperture Effect] Has Been Added to [Fn Button Set].....	F-18
[Photo Luminance Level] Has Been Added to [TV Connection].....	F-19
Support for AE Lock in [M] Mode	F-19

Support for Aperture/Shutter Speed Operations When Monitor is Off.....	F-19
Added Menus	F-20

Firmware Ver. 1.5 **F-22**

Support for 50p/25p Recording Qualities	F-22
[Switch NTSC/PAL] Has Been Added.....	F-22
50p/25p Recording Qualities Have Been Added	F-23
Improved Ease of Operation.....	F-25
Changes to How All Images Are Deleted.....	F-25
Added Menus	F-26

Firmware Ver. 1.6 **F-27**

Additions/Changes to AF Functions	F-27
Improved Automatic Detection AF Performance.....	F-27
Automatic Detection AF Has Been Added to [1-Area+]/[1-Area] ...	F-28
Support for the [AF+MF] Function During Recording of Video	F-29
Additions/Changes to Video Functions.....	F-30
[MOV] Has Been Added to [Rec. File Format] for Video to Support 5K Recording Qualities.....	F-30
[Like2100(HLG)] Has Been Added to [Photo Style] to Support HLG Video Recording	F-33
[16-235] Has Been Added to [Luminance Level]	F-35
[XLR Mic Adaptor Setting] Has Been Changed to Support Recording of High Resolution Audio	F-36
[4K/60p Bit Mode]/[4K/50p Bit Mode] Has Been Added to [HDMI Rec Output].....	F-37
[SS/Gain Operation] Has Been Added.....	F-38
[Red REC Frame Indicator] Has Been Added	F-39
Support for Vertical Playback of Video	F-39
Additions/Changes to Other Functions.....	F-40
Support for Transfer of 4K Video Files to Smartphones	F-40
Fn Buttons/Fn Lever	F-40
Added Menus	F-41

Before Use

About Applications/Software

When you have updated the firmware for the camera, use the latest version of the application for your smartphone or the software for your PC.

“LUMIX Sync”

- Install or update the application on your smartphone.
-

“PHOTOfunSTUDIO 10.1 PE”

- Check the following site and then download and install the software:

<If already using>

https://panasonic.jp/support/global/cs/soft/download/d_pfs101pe_up.html
(English only)

<If installing for the first time>

https://panasonic.jp/support/global/cs/soft/download/d_pfs1001pe.html
(English only)

“LUMIX Tether”

- Check the following site and then download and install the software:

https://panasonic.jp/support/global/cs/soft/download/d_lumixtether.html
(English only)

Firmware Ver. 1.2

Improved Image Stabilizer Performance

Image stabilizer performance has been improved.

Image stabilizer effect	In-body image stabilizer: 6.0 stops Based on the CIPA standard (Yaw/Pitch direction: focal length $f=50$ mm) (When using the interchangeable lens (S-X50)) Dual I.S.2*: 6.5 stops Based on the CIPA standard (Yaw/Pitch direction: focal length $f=105$ mm) (When using the interchangeable lens (S-R24105)) (Yaw/Pitch direction: focal length $f=200$ mm) (When using the interchangeable lens (S-R70200))
--------------------------------	--

- * Requires interchangeable lenses with a firmware version of 1.1 or higher. To check the firmware version of the lens, attach the lens to the camera and select [Firmware Version] in the [Setup] ([Others]) menu. You can also update the firmware in [Firmware Version].

For the latest information on the firmware or to download/update the firmware, visit the following support site:

<https://panasonic.jp/support/global/cs/dsc/>
(English only)

[AF-ON : Near Shift]/[AF-ON : Far Shift]

An Fn button function has been added so that AF operates giving priority to close-up or distant subjects.

 ⇒  ⇒  ⇒ [Fn Button Set] ⇒ Select [Setting in REC mode]

[1] tab:  [Focus/Shutter]

[AF-ON : Near Shift]	AF operates giving priority to close-up subjects. This function is useful when the camera mistakenly focuses on the background.
[AF-ON : Far Shift]	AF operates giving priority to distant subjects. This function is useful when taking pictures through fences or nets.

- These cannot be registered to [Fn3] to [Fn7].

Firmware Ver. 1.3

Support for CFexpress Cards

CFexpress cards are now supported.



You can use the following CFexpress cards.

CFexpress card (CFexpress Ver2.0 Type B)

- Operation with SanDisk CFexpress cards (64 GB to 512 GB) has been verified. (As of November 2019)
- AVCHD videos cannot be recorded with a CFexpress card.
- For the latest information, check the following support site:
<https://panasonic.jp/support/global/cs/dsc/>
(English only)

❖ Slot for CFexpress Cards

Insert CFexpress cards into card slot 1 (A).

- When using menu operations to select a card slot, select [Card Slot 1(XQD)].
- Format the cards with the camera before use in order to ensure optimal card performance.
[] ⇒ [] ⇒ [Card Format]
- The card may be hot just after the camera has been used. Be careful when removing.

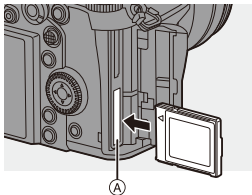



❖ Number of Burst Picture Frames (CFexpress Cards)

Number of burst picture frames	[FINE] / [STD.]: 50 frames or more [RAW+FINE] / [RAW+STD.]: 35 frames or more [RAW]: 40 frames or more When using a CFexpress card When recording is performed under the test conditions specified by Panasonic
---------------------------------------	---

❖ Notice Using CFexpress Cards

Notes about Backup Recording

[] ⇒ [] ⇒ [Double Card Slot Function] ⇒ [Recording Method] ⇒ [] ([Backup Rec])

- When using the following combinations of cards, recording videos, 6K/4K photos, and recording with [Post-Focus] are not available:
 - SDXC memory card and CFexpress card of 32 GB or less
 - SD memory card or SDHC memory card, and CFexpress card over 32 GB

Notes about 6K/4K Photos

- The file save method differs depending on the type of card.
 - CFexpress card of 32 GB or less:
A new file will be created to continue recording if the file size exceeds 4 GB.
 - CFexpress card over 32 GB:
Files are not divided for recording.

Notes about Creating Time Lapse Shot/Stop Motion Animation Videos

- In the following cases, videos cannot be created if the file size exceeds 4 GB:
 - When a CFexpress card of 32 GB or less is being used and the size for [Rec Quality] is set to [4K]
 - When the size for [Rec Quality] is set to [FHD]

Notes about [Rec. File Format]

[] ⇒ [] ⇒ [Rec. File Format]

- AVCHD videos cannot be recorded to CFexpress cards.

Notes about [Copy]

[] ⇒ [] ⇒ [Copy]

- When using the following combinations of cards, videos, 6K/4K photos, and images recorded with [Post-Focus] cannot be copied:
 - Copying from an SDXC memory card to a CFexpress card of 32 GB or less
 - Copying from a CFexpress card of over 32 GB to an SD memory card or SDHC memory card

❖ Dividing Files When Recording Videos (CFexpress Cards)

[Rec. File Format]	[Rec Quality]	Size interval for dividing files
[MP4]	FHD	A new file will be created to continue recording if the continuous recording time exceeds 30 minutes or the file size exceeds 4 GB.
	4K	<p>When using a CFexpress card of 32 GB or less: A new file will be created to continue recording if the file size exceeds 4 GB.</p> <p>When using a CFexpress card over 32 GB: Files are not divided for recording.</p>

Number of Recordable Pictures, Recordable Time (CFexpress Card)

Listed below are the numbers of pictures and the time lengths of videos that can be recorded on a CFexpress card.

❖ Number of Recordable Pictures

- The values are for when SanDisk CFexpress cards are used.
- The values listed are approximate.
- [Aspect Ratio]: [3:2]; [Picture Quality]: [FINE]

[Picture Size]	CFexpress card capacity			
	64 GB	128 GB	256 GB	512 GB
[L] (46.5M)	2600	5220	10270	20550
[M] (23.5M)	4920	9860	19140	38290
[S] (12M)	8870	17750	33660	67340
8K-Res.*	1270	2550	5050	10110

- [Aspect Ratio]: [3:2]; [Picture Quality]: [RAW+FINE]

[Picture Size]	CFexpress card capacity			
	64 GB	128 GB	256 GB	512 GB
[L] (46.5M)	670	1350	2690	5390
[M] (23.5M)	770	1540	3060	6140
[S] (12M)	820	1650	3290	6590
8K-Res.*	530	1060	2120	4240

* Indicates the number of pictures when [L]-size JPEG images are recorded simultaneously with [HLG Photo] set to [8K-Res.].

❖ Available Recording Time (When Recording Videos)



- “h” is an abbreviation for hour, “m” for minute and “s” for second.
- The recordable time is the total time of all the videos which have been recorded.
- The values are for when SanDisk CFexpress cards are used.
- The values listed are approximate.
- **[Rec. File Format]: [MP4]**



[Rec Quality]	CFexpress card capacity			
	64 GB	128 GB	256 GB	512 GB
[4K/LPCM/150M/60p]	56m00s	1h50m	3h45m	7h30m
[4K/100M/30p] [4K/100M/24p]	1h20m	2h45m	5h40m	11h20m
[FHD/28M/60p]	5h00m	10h05m	20h15m	40h30m
[FHD/20M/30p]	6h40m	13h25m	27h00m	54h05m

Improved Compatibility with Interchangeable Lenses

Changes to the Operation of the Image Stabilizer When Using Other Manufacturer's Lenses

Setting items for [Body(B.I.S.) / Lens(O.I.S.)] have been changed. [Body(B.I.S.) / Lens(O.I.S.)] can be set when using other manufacturer's lenses with an image stabilizer function.

 ⇒ [] ⇒ [] ⇒ [Image Stabilizer] ⇒ Select [Body(B.I.S.) / Lens(O.I.S.)]

 ([Body])	The in-body image stabilizer corrects for vertical, horizontal, and rotational shake.
 ([Lens + Body (Roll)])	The in-lens image stabilizer corrects for vertical and horizontal shake, while the in-body image stabilizer corrects for rotational shake.

[Lens Fn Button Setting] Has Been Added

Register a function to the focus button of an interchangeable lens.

 ⇒  ⇒  ⇒ Select [Lens Fn Button Setting]

Setting Items ([Lens Fn Button Setting])

– [Focus Stop]	– [AF-Point Scope]
– [AF Mode/MF]	– [Focus Area Set]
– [Focus Ring Lock]	– [Image Stabilizer]
– [AE LOCK]	– [Preview]
– [AF LOCK]	– [Preview Aperture Effect]
– [AF/AE LOCK]	– [No Setting]
– [AF-ON]	– [Off (Disable Press and Hold)]
– [AF-ON : Near Shift]	– [Restore to Default]
– [AF-ON : Far Shift]	

- [Focus Stop] is registered in the default setting.
When [Focus Stop] is used, the focus is locked while the focus button is pressed and held.
- When using an interchangeable lens that has a switch for the image stabilizer (normal/panning), [Image Stabilizer] in [Lens Fn Button Setting] is not available.

Changes to the AF Function

Support for [AF+MF] in AFC

When the focus mode is set to [AFC], [AF+MF] is now available.

When using AF, [AF+MF] can be used even when AF Lock is not engaged.

 ⇒  ⇒  ⇒ [AF+MF]

[MODE2] Has Been Added to [Continuous AF]

iA P A S M 



You can select how to set the focus in AF during recording videos.

The camera is now able to continue to focus even during video recording standby.

 ⇒  ⇒  ⇒ Select [Continuous AF]

[MODE1]	The camera continues to automatically focus only during recording. <ul style="list-style-type: none"> • The same functionality as [ON] in the past.
[MODE2]	The camera keeps focusing on subjects during recording standby and during recording. <ul style="list-style-type: none"> • The camera can keep focusing during recording standby when any of the following are set: <ul style="list-style-type: none"> – [AFM] mode – [Photo/Video Preview] in the [Custom] ([Monitor / Display]) menu is set to 
[OFF]	The camera maintains the focus point at the start of recording.



- In the [iA] mode, the camera automatically keeps focusing during recording standby, irrespective of the [Continuous AF] setting.
- When the following function is being used, [MODE1] switches to [MODE2]:
 - HDMI output
- [MODE2] does not work during recording standby in the following cases:
 - In preview mode
 - In low light situations

Support for Exposure Operations During [High Speed Video] Recording



When recording with [High Speed Video], it is now possible to set ISO sensitivity and [Exposure Mode].

Exposure operations appropriate to [Exposure Mode] ([P]/[A]/[S]/[M]) are possible.



→ [] → [] → [High Speed Video]

→ [] → [] → [Exposure Mode]

Additions/Changes to Other Functions

[Destination Card Slot] Has Been Added to the [RAW Processing] Setting Items



You can select the card slot to which to save images processed with RAW.

- 1 **Select [RAW Processing].**
 -  →  →  → [RAW Processing]
- 2 **Select the RAW image.**
- 3 **Select [More Settings] from the setting items.**
- 4 **Select [Destination Card Slot] and set the card slot to be saved to.**

[AUTO]	Saved to the same card slot as the RAW format image to be processed.
[1]	Saved to card slot 1.
[2]	Saved to card slot 2.

[0.5SEC] Has Been Added to the [Duration Time (photo)] of [Auto Review]

After taking a picture, the recorded image is displayed for approx. 0.5 seconds.

 → [] → [] → [Auto Review] → [Duration Time (photo)] → [0.5SEC]

Support for [Forced Flash Off] in [iA] Mode



It is now possible to set [Forced Flash Off] in [iA] mode.

 → [] → [] → [Flash Mode] → [] ([Forced Flash Off])

[AF Assist Light] Has Been Added to the [Video] Menu



[AF Assist Light] has been added to the [Video] ([Focus]) menu.

When in [] mode, it is now possible to set [AF Assist Light].

 → [] → [] → [AF Assist Light]

- This is a menu item in common with [AF Assist Light] in the [Photo] ([Focus]) menu. Their settings are synchronized.

[Off (Disable Press and Hold)] Has Been Added to [Fn Button Set]

A setting item has been added that disables display of the function registering screen even when you press and hold the Fn button.

 ⇒ [] ⇒ [] ⇒ Select [Fn Button Set]

[Setting in REC mode] ⇒ [3] tab:  [Others]

[Setting in PLAY mode] ⇒ [2] tab:  [Others]

[Off (Disable Press and Hold)]

The button does not work as an Fn button.
The function registering screen is not displayed when you press and hold (2 seconds) the Fn button.



- The firmware update has changed the default setting for [Fn6] and [Fn7] in [Setting in REC mode] from [No Setting] to [Off (Disable Press and Hold)].

[Preview Aperture Effect] Has Been Added to [Fn Button Set]

An Fn button function has been added so that you can preview the aperture effect.

 ⇒ [] ⇒ [] ⇒ [Fn Button Set] ⇒ Select [Setting in REC mode]

[2] tab:  [Monitor / Display]



[Preview Aperture Effect]

The aperture effect can be previewed while the Fn button is being pressed.

- These cannot be registered to [Fn3] to [Fn7].

[Photo Luminance Level] Has Been Added to [TV Connection]

Sets the level of luminance when outputting pictures to TVs, etc.

 ⇒ [] ⇒ [] ⇒ [TV Connection] ⇒ Select [Photo Luminance Level]

Settings: [0-255]/[16-255]



- When pictures recorded with [HLG Photo] are output without converting with [HLG View Assist], they are output with the setting [64-940].

Support for AE Lock in [M] Mode

When in [M] mode, it is now possible to use the AE Lock.

 ⇒ [] ⇒ [] ⇒ [Fn Button Set] ⇒ Select [Setting in REC mode]

[1] tab:  [Focus/Shutter]

[AE LOCK]

- The AE Lock can be used in [M] mode when the ISO sensitivity is set to [AUTO].

[AF/AE LOCK]

Support for Aperture/Shutter Speed Operations When Monitor is Off

Aperture value and shutter speed settings with the front dial and rear dial are now possible when the monitor is off.

Added Menu

















Specifications information for the menus added by the firmware update.

❖ List of Default Settings/Saving Customization/Copied Settings







: Using [Reset], the function to return to default settings

: Using [Save to Custom Mode], the function to save settings details in the Custom mode

: Using [Save/Restore Camera Setting], the function to copy settings details

Menu		Default settings			
 [Photo]:  [Flash]					
[Flash Mode]		[]	✓	✓	✓
 [Photo]:  [Others (Photo)]					
[Image Stabilizer]	[Body(B.I.S.) / Lens(O.I.S.)]	[]	✓	✓	✓
 [Video]:  [Focus]					
[Continuous AF]		[MODE1]	✓	✓	✓
[AF Assist Light]		[ON]	✓	✓	✓
 [Custom]:  [Monitor / Display]					
[Auto Review]	[Duration Time (photo)]	[OFF]	✓	✓	✓
 [Custom]:  [Lens / Others]					
[Lens Fn Button Setting]		[Focus Stop]	✓	✓	✓
 [Setup]:  [IN/OUT]					
[TV Connection]	[Photo Luminance Level]	[16-255]	✓		✓

❖ List of Functions That Can Be Set in Each Recording Mode

Menu		iA	P	A	S	M	M
 [Photo]:  [Flash]							
[Flash Mode]		✓	✓	✓	✓	✓	
 [Photo]:  [Others (Photo)]							
[Image Stabilizer]	[Body(B.I.S.) / Lens(O.I.S.)]	✓	✓	✓	✓	✓	
 [Video]:  [Focus]							
[Continuous AF]		✓	✓	✓	✓	✓	✓
[AF Assist Light]			✓	✓	✓	✓	✓

- SanDisk is a registered trademark or trademark of Western Digital Corporation or its affiliates in the US and/or other countries.

Firmware Ver. 1.5

Support for 50p/25p Recording Qualities

[Switch NTSC/PAL] has been added to the [Video] menu. Along with video for the NTSC TV broadcast system, it is now possible to record video with a frame rate for 50p/25p PAL.

[Switch NTSC/PAL] Has Been Added



The image qualities you can select in [Rec Quality] are switched to the image qualities with the frame rate to suit the NTSC/PAL TV broadcast system.

→ → → Select [Switch NTSC/PAL]

[NTSC]	The image qualities for NTSC can be selected in [Rec Quality]. <ul style="list-style-type: none">• The setting is [NTSC] in the default settings.
[PAL]	The image qualities for PAL can be selected in [Rec Quality]. <ul style="list-style-type: none">• AVCHD video cannot be recorded when set to [PAL].



- The recording qualities and frame rate can be selected to suit the [Switch NTSC/PAL] setting when turning group images recorded with [Time Lapse Shot] or [Stop Motion Animation] into video.
- If you record using the setting that differs from the broadcasting system of your region, it may not be possible for you to properly play back videos on your TV.

We recommend using the setting as it was at the time of purchase if you are unsure about broadcasting systems.

50p/25p Recording Qualities Have Been Added

iA P A S M 



When [Switch NTSC/PAL] is set to [PAL], recording qualities that can be selected have been added.

 →  →  → Select [Rec Quality]

[Rec. File Format]: [MP4]

[Switch NTSC/PAL]: [PAL]					
[Rec Quality]	Resolution	Frame rate	Bit rate	YUV/bit	Audio format
[4K/LPCM/150M/50p]* ^{1,2}	3840×2160	50p	150 Mbps	4:2:0/8 bit	LPCM
[4K/100M/25p]* ²	3840×2160	25p	100 Mbps	4:2:0/8 bit	AAC
[FHD/28M/50p]	1920×1080	50p	28 Mbps	4:2:0/8 bit	AAC
[FHD/20M/25p]	1920×1080	25p	20 Mbps	4:2:0/8 bit	AAC

*1 These videos are intended for editing on a PC.

Playback and editing on other than this camera require a high-performance PC environment.

*2 Recording stops when the continuous recording time exceeds 15 minutes.



- All videos will be recorded using Long GOP to compress the images.
- When recording 4K videos to an SD card, use a card rated at UHS Speed Class 3 or higher.

❖ Video Recording Time

Listed below are the time lengths of videos that can be recorded on a card.

- Video recording time is the total time of all the videos which have been recorded.
- The values listed are approximate.
- “h” is an abbreviation for hour, “m” for minute and “s” for second.

- **[Rec. File Format]: [MP4]**

[Rec Quality]	XQD card capacity				SD card capacity		
	32 GB	64 GB	120 GB	240 GB	32 GB	64 GB	128 GB
[4K/LPCM/150M/50p]	27m00s	53m00s	1h35m	3h10m	27m00s	56m00s	1h50m
[4K/100M/25p]	40m00s	1h20m	2h20m	4h45m	41m00s	1h25m	2h45m
[FHD/28M/50p]	2h25m	4h45m	8h35m	17h10m	2h30m	5h00m	9h55m
[FHD/20M/25p]	3h15m	6h20m	11h25m	22h55m	3h20m	6h40m	13h15m

[Rec Quality]	CFexpress card capacity			
	64 GB	128 GB	256 GB	512 GB
[4K/LPCM/150M/50p]	56m00s	1h50m	3h45m	7h30m
[4K/100M/25p]	1h20m	2h45m	5h40m	11h20m
[FHD/28M/50p]	5h00m	10h05m	20h15m	40h30m
[FHD/20M/25p]	6h40m	13h25m	27h00m	54h05m

Improved Ease of Operation

Changes to How All Images Are Deleted

To prevent unintentional deletion of images, touch operations are prohibited in some screens for deleting all images.



Touch operation allowed

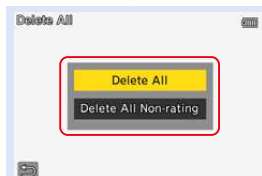

Touch operation not allowed*

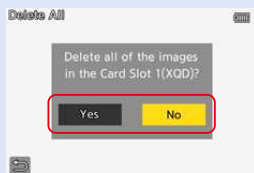

Touch operation not allowed*

* [] can be operated with a touch operation.

Added Menu





Specifications information for the menu added by the firmware update.

❖ List of Default Settings/Saving Customization/Copied Settings



: Using [Reset], the function to return to default settings

: Using [Save to Custom Mode], the function to save settings details in the Custom mode

: Using [Save/Restore Camera Setting], the function to copy settings details

Menu	Default settings			
 [Video]:  [Image Format]				
[Rec Quality]	[FHD/28M/60p]	✓	✓	✓
[Switch NTSC/PAL]	[NTSC]	✓	✓	✓

❖ List of Functions That Can Be Set in Each Recording Mode

Menu	iA	P	A	S	M	
 [Video]:  [Image Format]						
[Rec Quality]	✓	✓	✓	✓	✓	✓
[Switch NTSC/PAL]	✓	✓	✓	✓	✓	✓

Firmware Ver. 1.6



Additions/Changes to AF Functions

Improved Automatic Detection AF Performance



Automatic detection is now able to detect the heads of people whose faces are not facing directly to the front.

The item names have been changed from [Face/Eye/Body Detection] to [Human Detect AF], and from [Face/Eye/Body/Animal Detect.] to [Human/Animal Detect AF] accordingly.

 [Human Detect AF]	The camera detects a person's face, eyes, and body (entire body, upper half of the body, or head) and adjusts the focus.
 [Human/Animal Detect AF]	Along with humans, animals such as birds, canines (including wolves), and felines (including lions) will be detected. Animals will be prioritized for detection over humans.



Automatic Detection AF Has Been Added to [1-Area+]/[1-Area]



Automatic detection is now available in the [1-Area+]/[1-Area] AF modes. When a part of a human or animal enters the [1-Area+]/[1-Area] AF area, the automatic detection AF area is indicated in yellow.

Eye detection works when a person's face is inside the AF area.

❖ Switching of Automatic Detection

- 1 Press [] to display the AF mode selection screen.
- 2 Select [] or [] and then press ▲.
 - Each press of ▲ switches automatic detection.
 - The automatic detection settings of [1-Area+] and [1-Area] are linked.

Automatic detection:
OFF



[Human Detect AF]:
ON



[Human/Animal
Detect AF]: ON

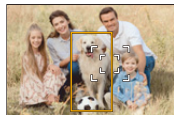

-  • Only 1 human or animal can be automatically detected in the AF area.
- You cannot change the person, animal or eye being focused on during automatic detection.

Support for the [AF+MF] Function During Recording of Video



During video recording, the MF mode is engaged when you rotate the focus ring, and the AF mode is engaged when you stop rotating the focus ring.

 →  →  → [AF+MF]



- When [Continuous AF] is set to [MODE2], the focus can be adjusted manually even during recording standby.

Additions/Changes to Video Functions



[MOV] Has Been Added to [Rec. File Format] for Video to Support 5K Recording Qualities

[MOV] added to [Rec. File Format] enables recording of MOV format video. When set to [MOV], recording qualities with resolution of 5K and 10-bit can be set.

- The angle of view becomes narrower.

→ → → Select [Rec. File Format]

[MOV] This data format is suitable for image editing.

Video Recording Quality Available for [MOV]

→ → → Select [Rec Quality]

[Rec. File Format]: [MOV]

[Switch NTSC/PAL]: [NTSC]

[Rec Quality]	Resolution	Frame rate	Bit rate	YUV/bit	Audio format
[5K/10bit/200M/30p]	4992×3744	30p	200 Mbps	4:2:0/10 bit	LPCM
[5K/10bit/200M/24p]	4992×3744	24p	200 Mbps	4:2:0/10 bit	LPCM

[Switch NTSC/PAL]: [PAL]

[Rec Quality]	Resolution	Frame rate	Bit rate	YUV/bit	Audio format
[5K/10bit/200M/25p]	4992×3744	25p	200 Mbps	4:2:0/10 bit	LPCM

- In this document, videos are indicated as follows according to their resolution:
 - 5K (4992×3744) video: **5K video**



- All videos will be recorded using Long GOP to compress the images.
- When recording to an SD card, use a card rated at UHS Speed Class 3 or higher.
- [Image Area of Video] is fixed to [PIXEL/PIXEL].
- Recording stops when the continuous recording time exceeds 15 minutes.
- MOV format video recording is not available when [Filter Settings] is set to [Miniature Effect].
- When using APS-C lenses, recording of 5K video is not available.
- When the following function is being used, [E-Stabilization (Video)] is not available:
 - 5K video
- The “PHOTOfunSTUDIO” software for PCs cannot handle 5K video.

❖ Size Interval for Dividing Files

[Rec. File Format]	[Rec Quality]	Size interval for dividing files
[MOV]	All	<p>When using an SDHC memory card or an XQD card/CFexpress card of 32 GB or less: A new file will be created to continue recording if the continuous recording time exceeds 30 minutes or the file size exceeds 4 GB.</p> <p>When using an SDXC memory card or an XQD card/CFexpress card over 32 GB: A new file will be created to continue recording if the continuous recording time exceeds 3 hours and 4 minutes or the file size exceeds 96 GB.</p>

❖ Available Recording Time for the Battery (When Using the Monitor)

Listed below are the time lengths available for recording that can be taken when the supplied battery is being used.

- Using the XQD card from Sony.
- Using the interchangeable lens (S-R24105).
- The values listed are approximate.
- Actual recordable time is the time available for recording when repeating actions such as turning the camera on and off, starting/stopping recording, etc.

[MOV] (Recording with the recording quality set to [5K/10bit/200M/30p])

Recordable time	Approx. 70 min
Actual recordable time	Approx. 35 min

❖ Available Recording Time for Cards

Listed below are the time lengths of videos that can be recorded on a card.

- The available recording time is the total time of all the videos which have been recorded.
- The values listed are approximate.
- **[Rec. File Format]: [MOV]**
- “h” is an abbreviation for hour, “m” for minute and “s” for second.

[Rec Quality]	XQD card capacity				SD card capacity		
	32 GB	64 GB	120 GB	240 GB	32 GB	64 GB	128 GB
[5K/10bit/200M/30p] [5K/10bit/200M/24p] [5K/10bit/200M/25p]	19m00s	39m00s	1h10m	2h20m	20m00s	42m00s	1h20m

[Rec Quality]	CFexpress card capacity			
	64 GB	128 GB	256 GB	512 GB
[5K/10bit/200M/30p] [5K/10bit/200M/24p] [5K/10bit/200M/25p]	42m00s	1h20m	2h50m	5h40m

[Like2100(HLG)] Has Been Added to [Photo Style] to Support HLG Video Recording



When the recording quality is set to MOV format 10-bit, you can record HLG format video with a wide dynamic range.

Bright lights that are easily overexposed, and dark areas that are easily underexposed can be recorded showing fine quality and rich colors just as seen with the human eyes.

You can view the video that you record by outputting via HDMI to devices (TVs, etc.) that support the HLG format, or playing back directly on supporting devices.

- “HLG (Hybrid Log Gamma)” is an international standard (ITU-R BT.2100) HDR format.

- 1 Set the mode dial to [M].
 - [Like2100(HLG)] is available only when the camera is set to [M] mode.
- 2 Set [Rec. File Format] to [MOV].
 - ⇒ ⇒ ⇒ [Rec. File Format] ⇒ [MOV]
- 3 Select [Rec Quality].
 - ⇒ ⇒ ⇒ [Rec Quality] ⇒ Video recording quality
 - Items available for recording with [Like2100(HLG)] are indicated as [HLG available] on the screen.
- 4 Set [Photo Style] to [Like2100(HLG)].
 - ⇒ ⇒ ⇒ [Photo Style] ⇒ [Like2100(HLG)]



- The monitor and viewfinder on this camera do not support display of HLG format images.
With [Monitor] in [HLG View Assist] in the [Custom] ([Monitor / Display]) menu, you can display the images converted for monitoring on the monitor/viewfinder of this camera.
- HLG images are shown dark on devices that do not support the HLG format.
With [HDMI] in [HLG View Assist] in the [Custom] ([Monitor / Display]) menu, you can set the conversion method for images displayed for monitoring.

❖ [Like2100(HLG)] Has Been Added to [Photo Style]



→ [] → [] → Select [Photo Style]



[Like2100(HLG)]*

A setting used to record HLG format video.

* Can only be selected when in the [M] mode and set to a 10-bit [Rec Quality].

- The items that you can adjust the image quality for depend on the Photo Style type.

				 ([Saturation])	 ([Color Tone])					
	—	—	—	✓	—	✓	—	—	✓	✓



- When [Photo Style] is set to [Like2100(HLG)], the following functions are restricted:
 - The lower limit of available ISO sensitivities will become [ISO320].
 - [i.Dynamic Range] is fixed to [OFF].
 - [Luminance Level] is fixed to [64-940].

[16-235] Has Been Added to [Luminance Level]

iA P A S M 



The [16-235] setting item is added, and operation changes to the following.

 → [] → [] → Select [Luminance Level]

Settings: [0-255]/[16-235]/[16-255]



- When [Rec Quality] is set to 10-bit video, the setting items change to [0-1023], [64-940], and [64-1023].
- When [Rec. File Format] is set to [AVCHD], [0-255] cannot be set.
- When [Photo Style] is set to [Like2100(HLG)], this is fixed to [64-940].

[XLR Mic Adaptor Setting] Has Been Changed to Support Recording of High Resolution Audio



Sampling frequency can be set.

Recording of high resolution audio is supported when recording MOV format video.

→ → → Select [XLR Mic Adaptor Setting]

[96kHz/24bit]	Records high resolution sound at 96 kHz/24-bit.	Only available when [Rec. File Format] is set to [MOV].
[48kHz/24bit]	Records high-quality sound at 48 kHz/24-bit.	
[48kHz/16bit]	Records standard-quality sound at 48 kHz/16-bit.	
[OFF]	Records sound using the built-in microphone of the camera.	

- The set sampling frequency is also applied to the sound output over HDMI.

❖ Down-converting Audio and Outputting to HDMI

[96kHz/24bit] and [48kHz/24bit] audio is down-converted to match the connected device.

→ → → [HDMI Rec Output] → Select [Sound Down Convert]

Settings: [AUTO]/[OFF]

[4K/60p Bit Mode]/[4K/50p Bit Mode] Has Been Added to [HDMI Rec Output]



In the [P/M] mode, setting of output bit value for images output over HDMI is possible for 4K/60p or 4K/50p video.

→ [Video] → [Camera] → [HDMI Rec Output] → Select [4K/60p Bit Mode]/[4K/50p Bit Mode]

Settings: [4:2:2 10bit]/[4:2:0 8bit]



- The menu name changes according to the [Switch NTSC/PAL] setting.
- This works in the [P/M] mode, when set to [Rec Quality] of 4K/60p or 4K/50p, and outputting over HDMI.
- When using HDMI output for 4K/60p/4:2:2 10-bit or 4K/50p/4:2:2 10-bit images, video cannot be recorded to a card.
- When using HDMI output for HLG video, during HDMI output of 4K/60p/4:2:2 10-bit or 4K/50p/4:2:2 10-bit images, from the [Video] ([Image Quality]) menu, set [Photo Style] to [Like2100(HLG)].

[SS/Gain Operation] Has Been Added

iA P A S M 



It is now possible to set the shutter speed by angle and the gain (sensitivity) by dB units.

 ⇒  ⇒  ⇒ Select [SS/Gain Operation]

[SEC/ISO]	Displays the shutter speed in seconds and the gain in ISO.
[ANGLE/ISO]	Displays the shutter speed in degrees and the gain in ISO. <ul style="list-style-type: none"> • The angle can be set in a range between 11° and 358°.
[SEC/dB]	Displays the shutter speed in seconds and the gain in dB. <ul style="list-style-type: none"> • 0 dB is equivalent to [ISO100].



- When [SS/Gain Operation] is set to [SEC/dB], menu names change as shown below:
 - [ISO Sensitivity (video)] ⇒ [Gain Setting]
 - [ISO Auto Lower Limit Setting] ⇒ [Auto Gain Lower Limit Setting]
 - [ISO Auto Upper Limit Setting] ⇒ [Auto Gain Upper Limit Setting]
 - [Extended ISO] ⇒ [Extended Gain Setting]
 - [ISO Displayed Setting] ⇒ [Gain Displayed Setting]
- When [SS/Gain Operation] is set to [SEC/dB], the icon in the Touch Tab changes from [ISO] to [GAIN].

[Red REC Frame Indicator] Has Been Added



A red frame is displayed on the recording screen that indicates that video is being recorded.

 →  →  → [Red REC Frame Indicator]

Settings: [ON]/[OFF]

Support for Vertical Playback of Video

When video is recorded with the camera held vertically, the video is automatically played back vertically on smartphones and PCs.



- In the camera playback screen, playback is vertical only in the thumbnail display.

Additions/Changes to Other Functions

Support for Transfer of 4K Video Files to Smartphones

It is now possible to transfer 4K MP4 video files to smartphones.



- It is not possible to transfer images with file sizes exceeding 4 GB.
- Images recorded using the following function cannot be transferred:
 - Audio format: LPCM

Fn Buttons/Fn Lever

Usage of the following functions is enabled.

Fn buttons

⇒ ⇒ ⇒ [Fn Button Set]

[Setting in REC mode]	[1] tab	[Image Quality]	[Photo Style] – [Like2100(HLG)]
	[2] tab	[Audio]	– [XLR Mic Adaptor Setting]

Fn lever

⇒ ⇒ ⇒ [Fn Lever Setting]

- When [Function of Fn Lever] is set to [Photo Style]:
 - [Like2100(HLG)]

Added Menu











Specifications information for the menus added by the firmware update.

❖ List of Default Settings/Saving Customization/Copied Settings

: Using [Reset], the function to return to default settings

: Using [Save to Custom Mode], the function to save settings details in the Custom mode

: Using [Save/Restore Camera Setting], the function to copy settings details

Menu		Default settings			
 [Video]:  [Image Quality]					
[SS/Gain Operation]		[SEC/ISO]	✓	✓	✓
 [Video]:  [Audio]					
[XLR Mic Adaptor Setting]		[48kHz/16bit]	✓	✓	✓
 [Video]:  [Monitor / Display]					
[HDMI Rec Output]	[Sound Down Convert]	[OFF]	✓	✓	✓
	[4K/60p Bit Mode]/ [4K/50p Bit Mode]	[4:2:0 8bit]	✓	✓	✓
 [Custom]:  [Monitor / Display]					
[Red REC Frame Indicator]		[OFF]	✓	✓	✓

❖ List of Functions That Can Be Set in Each Recording Mode

Menu		iA	P	A	S	M	MM
[Video]: [Image Quality]							
[SS/Gain Operation]							✓
[Video]: [Audio]							
[XLR Mic Adaptor Setting]		✓	✓	✓	✓	✓	✓
[Video]: [Monitor / Display]							
[HDMI Rec Output]	[Sound Down Convert]	✓	✓	✓	✓	✓	✓
	[4K/60p Bit Mode]/ [4K/50p Bit Mode]	✓	✓	✓	✓	✓	✓

- QuickTime and the QuickTime logo are trademarks or registered trademarks of Apple Inc., used under license therefrom.

