

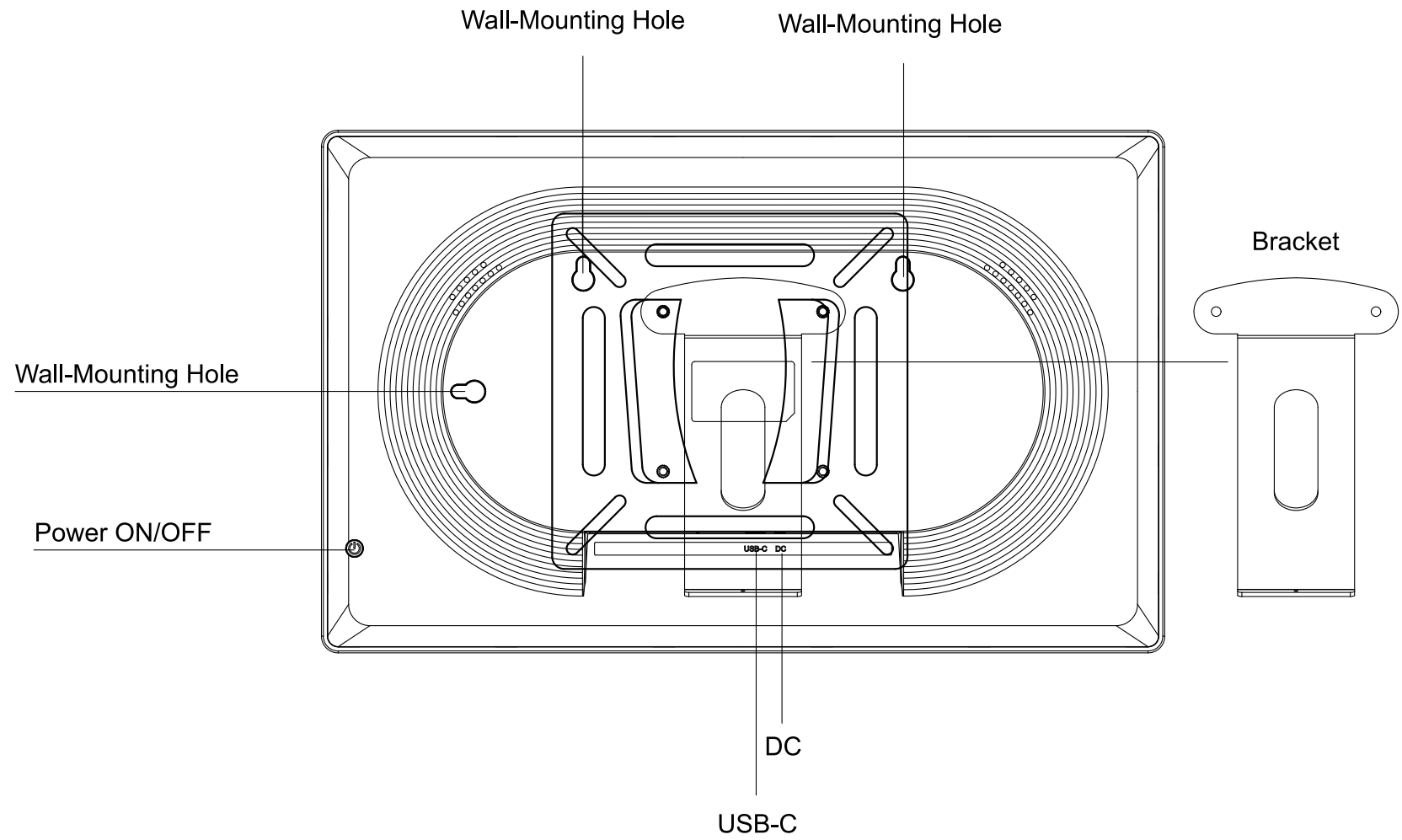

# Smart Digital Calendar

KF1560 / KF2150

User Manual





# Power Button

Hold the power button for about 5 seconds to power on the frame.  
when the frame is on, press the power button once to turn the screen on or off.  
Hold the power button for about 2 seconds to get power off option.  
To avoid any possible damage to the frame, please do not unplug the power adapter from the frame while the device is on.

Product Specifcation	
Screen	<input type="checkbox"/> 15.6" <input type="checkbox"/> 21.5"
Resolutior	1920x1080 FHD
WI-FI	2.4GHz / 5GHz
CPU	A523Cortex™M-A7 Quad Core
Memory	3GB
Storage*	32G



## Before Device Installation

### Wall-Mounting Tips

Take the height of all device users into consideration. It is recommended to install the device at an eye-level height.

Ensure sufficient space for both horizontal and vertical mounting orientations.

Do not drill holes above wall studs, electrical wires, or pipes.

Before installation, unplug the device from the power socket and keep it away from water sources.

### Required tools



### Other accessories inside the packaging box

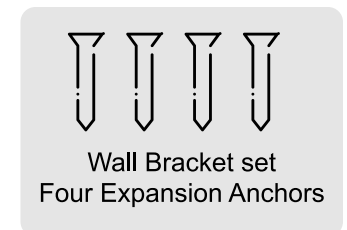
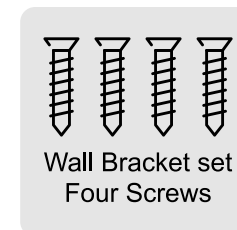
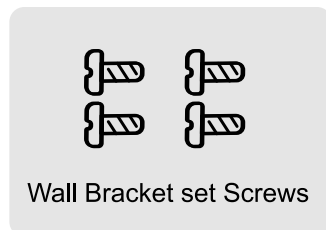
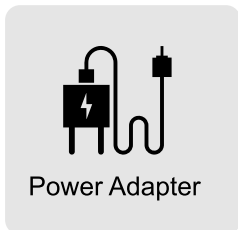



## Download Vcivik app on your mobile phone

To share your schedule with compatible calendar devices worldwide, please first download the free Vcivik app on your mobile device.

Search for "Vcivik" in the App Store (iOS) or Google Play (Android) to download the Vcivik app.



### Bind and Connect Devices

To synchronize your schedule with the Calendar, you need to connect the Vcivik app to the Calendar device. Follow the steps below for connection:



Download the "Vcivik APP" through your mobile phone

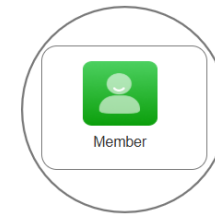

Open the device's member management

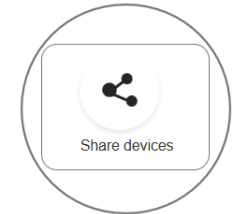

Open Share Device



View the device sharing code; this code is valid for 12 hours.

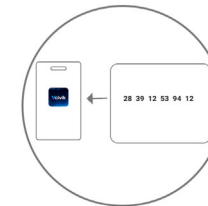

Enter the device code in the "Vcivik APP" to bind the device

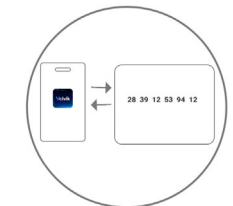

You can now synchronize your mobile phone with the calendar



## Functions on Device Home page:

The home page serves as the main dashboard for family collaboration and management, integrating eight core modules: Calendar, Chores, Rewards, To-Do List, Meal Planning, Photo Album, and Member Management. Users can quickly view the current month's dates, to-do lists, chores, member rewards, and daily meal plans.

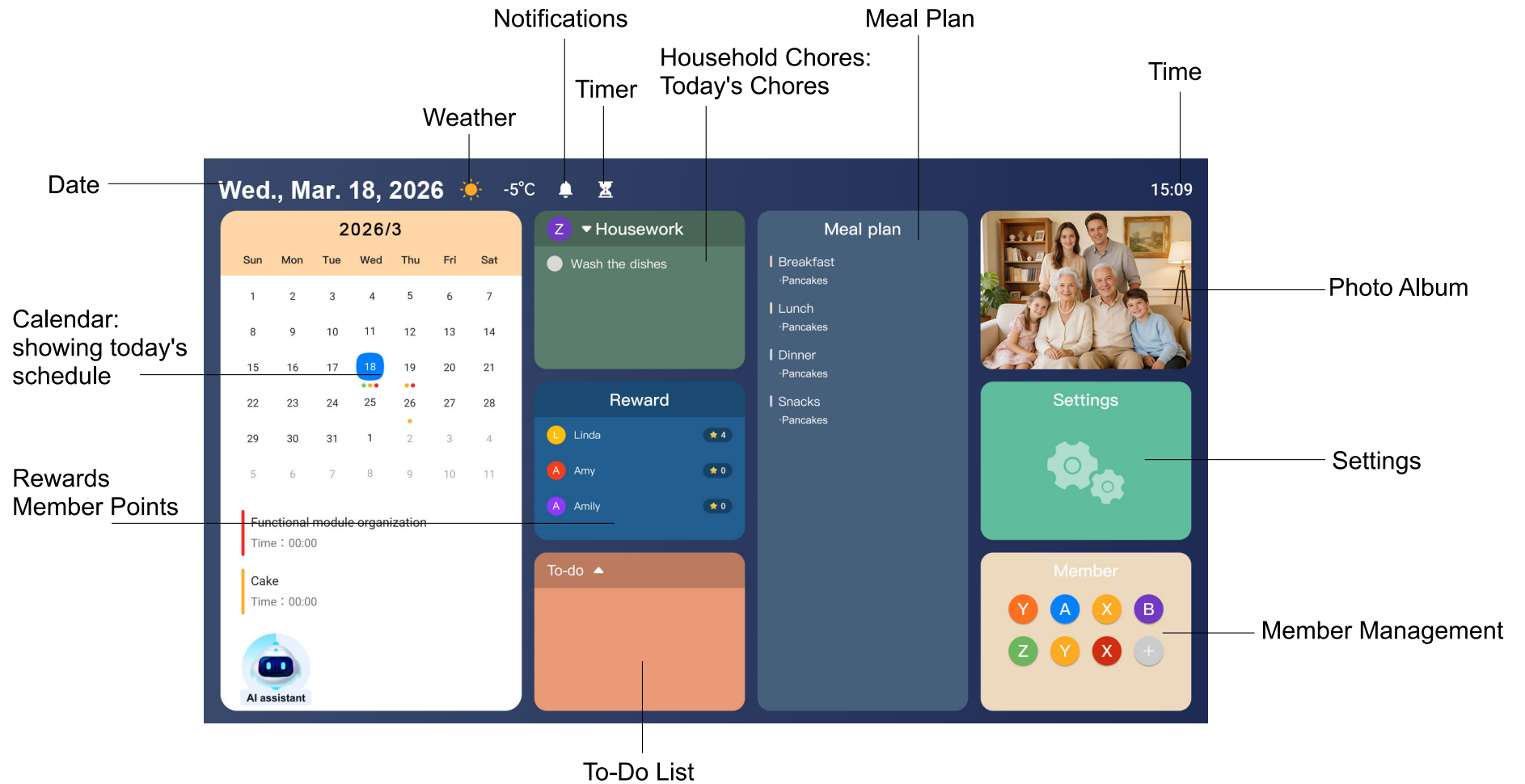



## Voice Wake-up Interface

Once you have completed the basic setup and entered the main interface of the digital calendar, you can use the voice assistant to wake up your device. Simply say: "Hi, Viki!" The device will then display the following windows and features:

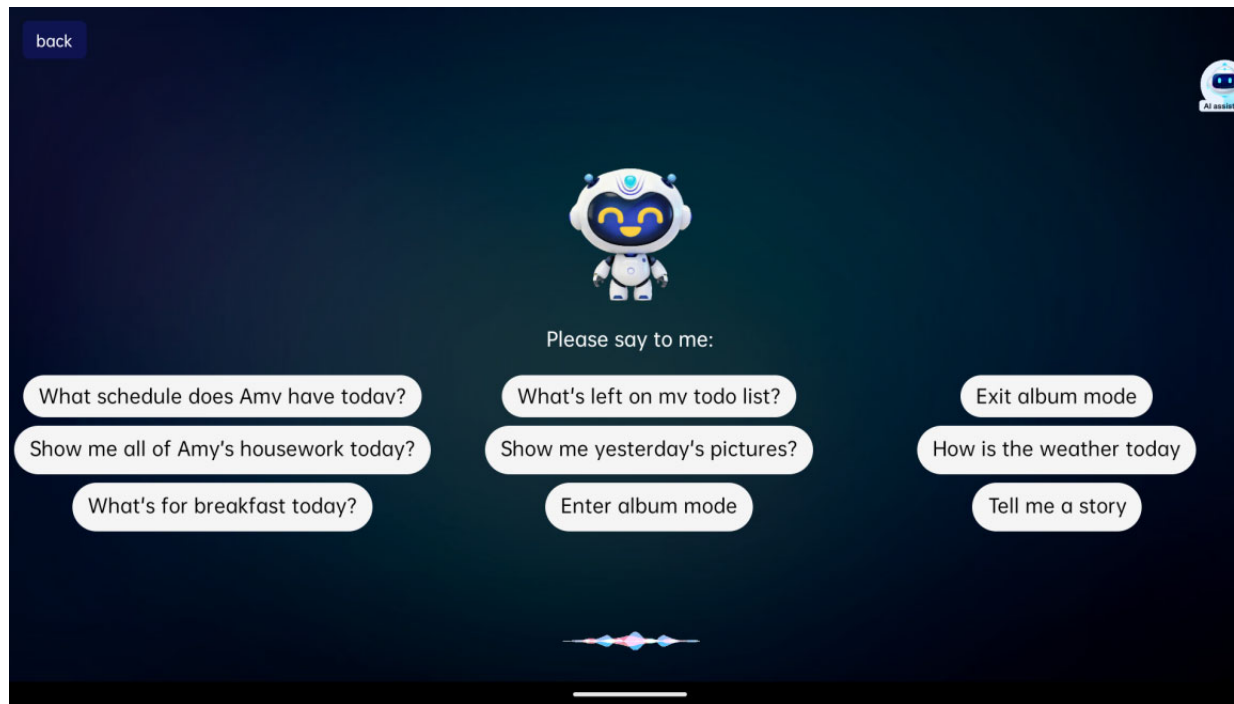

A series of common voice command cards will typically be listed at the bottom of the window to guide new users:



## AI Voice Interaction Mode

Experience seamless AI Voice Conversation with Viki. You can ask the AI assistant questions ranging from general knowledge to real-time data.

"Hi, Viki! How is the weather like today?"

"Hi, Viki! Tell me a story.."

"Hi, Viki! How many ounces are in a cup?"

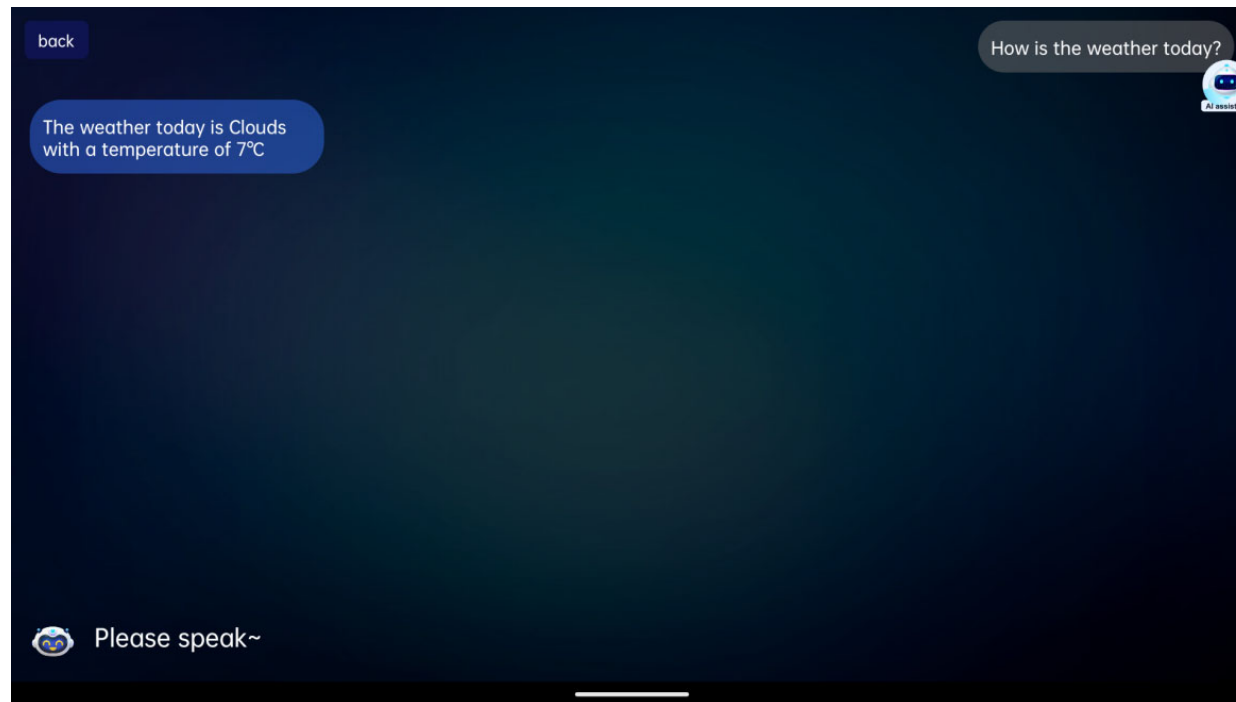

The assistant stays active for 15 seconds after replying, allowing you to ask follow-up questions. It will auto-exit after 15 seconds of inactivity. To re-activate, say 'Hi, Viki!'



## Voice Command Interaction

Truly Hands-Free Experience. Stop tapping and start talking. Our digital calendar eliminates the need for manual input, letting you control everything with simple voice commands:

Manage Tasks: Create to-do lists and reminders instantly.

Timers & Alarms: Stay on schedule with voice-set alerts.

Kitchen Companion: Easily look up and follow recipes.

Memories: Open and browse your photo gallery with ease

For a complete list of supported voice commands, please tap the link below:

[https://theapeths.com/voice\\_command\\_for-en.html](https://theapeths.com/voice_command_for-en.html)

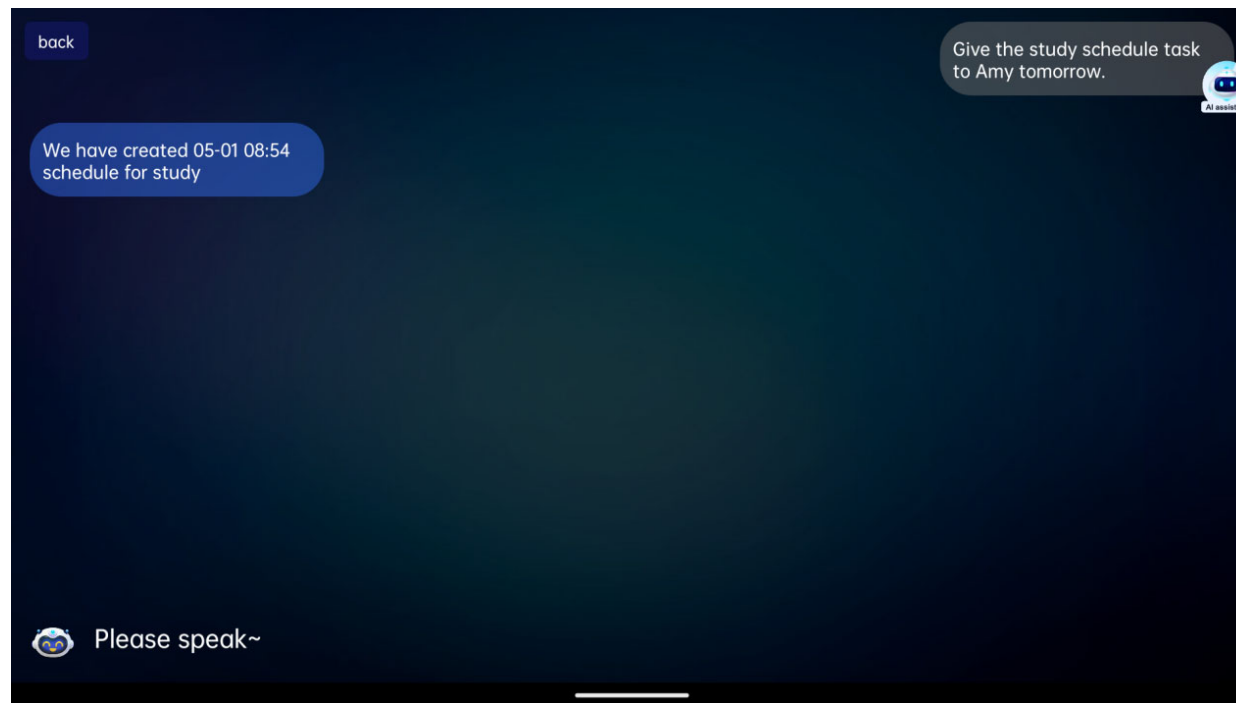



# Calendar Features

The Calendar module is a time management and event reminder tool that helps you record and keep track of important dates, daily schedules and countdown events.

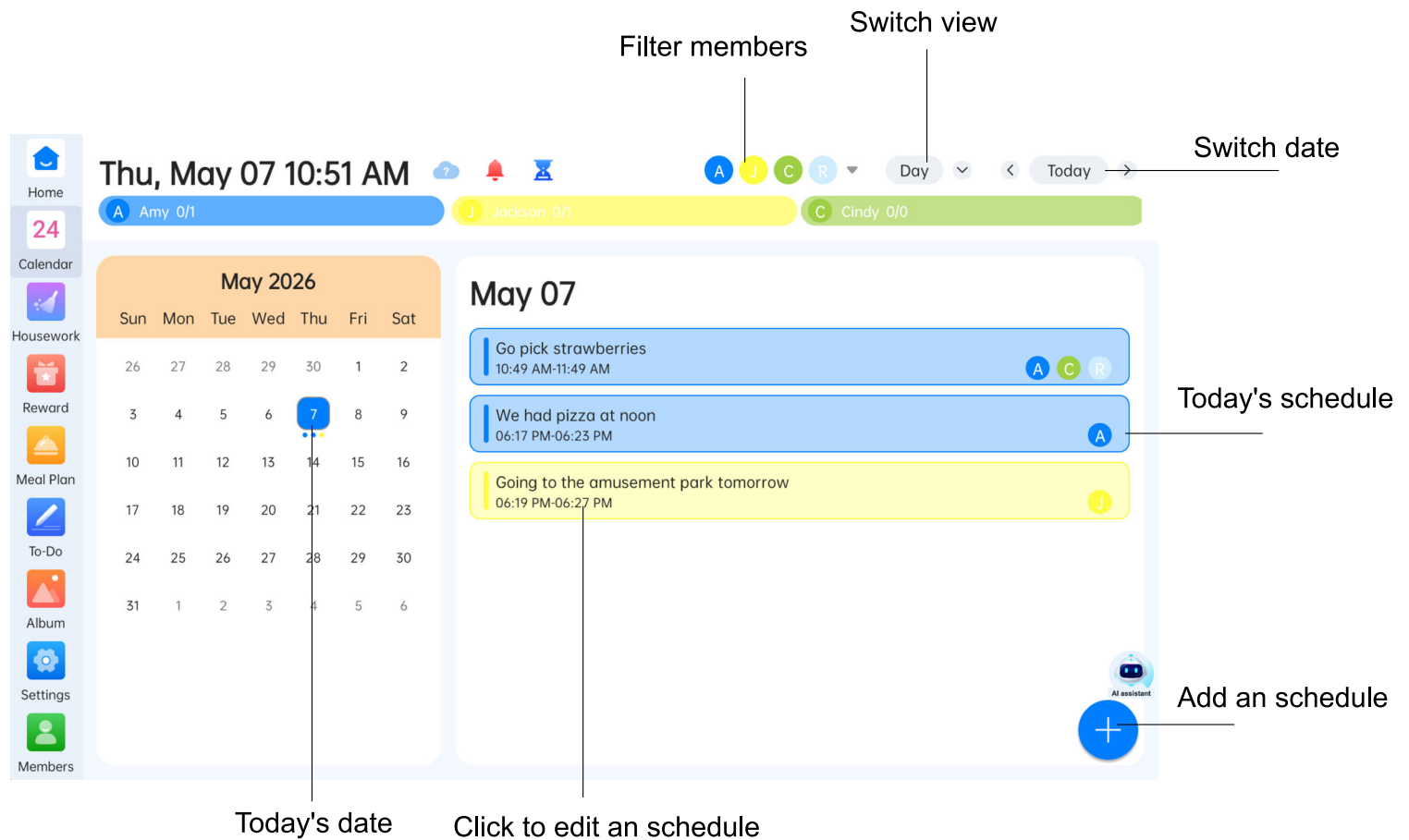



## Introduction to Household Functions

The Household Chores module is a task allocation and progress tracking tool within the Family Collaboration Dashboard, designed to create, assign and track the completion of daily household chores. It displays all household tasks in a list format, links them to family members, and tracks each person's progress in real time.

The screenshot shows the Household Chores mobile app interface. At the top, it displays the date and time: "Thu, May 07 10:54 AM". To the right of the date is a "Member filter" section with four colored circles representing family members: Amy (A), Jackson (J), Cindy (C), and Ruth (R). Further right is a "Switch date" button labeled "Today".

The main content area is divided into four vertical columns, each representing a family member's chores for the day:

- Amy (A):** 0/1 chores completed, 0 reward points. Chores: "wash the dishes" (2026-05-07) with a blue checkmark.
- Jackson (J):** 0/2 chores completed, 0 reward points. Chores: "wash clothes" (2026-05-07) and "wipe the table" (2026-05-07), both with blue checkmarks.
- Cindy (C):** 0/1 chores completed, 0 reward points. Chores: "Mop the floor" (2026-05-07) with a blue checkmark.
- Ruth (R):** 0/2 chores completed, 0 reward points. Chores: "Cooking and washing dishes, making dinner" (2026-05-07) and "tidy up the room" (2026-05-07), both with blue checkmarks.

At the bottom right of the Ruth column is a blue circular button with a white plus sign and an "AI assistant" icon, labeled "Add a chore".

Annotations with lines pointing to specific elements include:

- "Amount of housework" pointing to the "0/1" or "0/2" progress indicators.
- "Member filter" pointing to the colored circles (A, J, C, R).
- "Switch date" pointing to the "Today" button.
- "Members' chores for the day" pointing to the list of chores for each member.
- "Add a chore" pointing to the plus button.
- "Once you have finished your chores for the day, tap the 'Complete' button" pointing to the blue checkmark on the "wash the dishes" task.
- "Earn reward points via the mobile app after completing your chores" pointing to the "0" reward point indicators.



# Introduction to Meal Planning

The Meal Planning module is a dietary planning and menu management tool within the Family Collaboration Dashboard. It helps family members organize daily meals (breakfast, lunch, dinner) in advance, as well as manage snacks and dining out. It supports a weekly view to display the menu and allows you to add specific dishes.

The screenshot displays the Meal Planning interface. At the top, it shows the current date and time: "Thu, May 07 11:05 AM". Below this is a navigation bar with a "Category" dropdown and "Today" navigation buttons. The main content is a weekly menu grid with columns for each day from Sunday to Saturday. The rows represent different meal categories: Breakfast, Lunch, Dinner, and Snack. Each cell in the grid contains a specific meal name. A sidebar on the left contains navigation icons for Home, Calendar, Housework, Reward, Meal Plan, To-Do, Album, Settings, and Members. Callouts point to specific features: "Meal Name" points to the text in a cell, "Show / Hide Meal Names and Edit" points to the Category dropdown, and "Display Menu by Week" points to the weekly grid view.

	Sun 03	Mon 04	Tue 05	Wed 06	Thu 07	Fri 08	Sat 09
Breakfast	Eggs	Oatmeal	Milk & Cereal	Oatmeal	Eggs	Oatmeal	Bagels
Lunch	Salad	Simple Hydration	Spicy Garlic Shrimp	Simple Hydration	Salad	Hot Dogs	Milk Oatmeal
Dinner	Tacos	Tacos	Classic Spaghetti Bolognese	Eat Out	Spaghetti	Takeout ing	Takeout ing
Snack	Cheese and Crackers	Potato Chips	Fruit	Cheese and Crackers	Cheese and Crackers	Carrots and Hummus	Potato Chips



## Introduction to the Rewards Feature

The Rewards Module serves as the Incentives and Redemption Centre within the Family Collaboration Dashboard. It enables parents to create reward tasks (via the 'vcivik' mobile app), whilst family members earn stars (points) by completing household chores. Once they have accumulated enough stars, they can redeem them for corresponding rewards. This module links household chores with positive incentives, fostering a sense of responsibility and purpose among family members.

The screenshot displays the Rewards Module interface. At the top, it shows the date and time: "Thu, May 07 11:04 AM". Below this, there are four reward cards for different family members: Amy (blue), Jackson (yellow), Cindy (green), and Ruth (pink). Each card features a profile picture, a name, a star count, a reward task with an emoji, and a progress bar showing stars earned and stars required. Annotations with lines pointing to specific elements are as follows:

- Member Profile Picture:** Points to the profile picture of Amy.
- Number of stars required to claim the reward:** Points to the "6/10" progress bar on Amy's card.
- Show / Hide Redeemed Rewards:** Points to the "Display Redeemed" toggle switch at the top right.
- Click to redeem rewards once you have enough stars:** Points to the "AI assistant" icon at the bottom right of the Ruth card.

Member	Stars Earned	Stars Required	Reward Task
Amy	6	10	Go out to eat pizza
Jackson	5	5	Hamburger Set Meal
Cindy	0	6	est ice cream
Ruth	5	9	go to the amusement park



## Introduction to the To-Do List Feature

The Rewards Module serves as the Incentives and Redemption Centre within the Family Collaboration Dashboard. It enables parents to create reward tasks (via the 'vcivik' mobile app), whilst family members earn stars (points) by completing household chores. Once they have accumulated enough stars, they can redeem them for corresponding rewards. This module links household chores with positive incentives, fostering a sense of responsibility and purpose among family members.

The screenshot displays a mobile application interface for a To-Do list. On the left is a vertical sidebar with navigation icons for Home, Calendar (showing '24'), Housework, Reward, Meal Plan, To-Do (selected), Album, Settings, and Members. The main content area shows a date and time 'Thu, May 07 11:07 AM' and a 'Show Completed' toggle. Below this are three task categories: 'Purchase daily necessities' (3 items), 'Spring outing' (1 item), and 'Family chores' (0 items). A list of tasks follows: 'buy strawberries' (unchecked), 'shampoo' (checked), and 'toothpaste' (unchecked). At the bottom of the task list is a '+Add Sub-Tasks' button. An 'AI assistant' icon is visible in the bottom right corner of the task list area. Annotations with lines pointing to specific elements include: 'Number of sub-tasks in the to-do list' pointing to the '3 Items' badge; 'Add a to-do item' pointing to the bottom '+' button; 'Show / Hide Redeemed Rewards' pointing to the 'Show Completed' toggle; 'This status indicates the task is complete' pointing to the checked 'shampoo' task; 'This status indicates the task is incomplete' pointing to the unchecked 'toothpaste' task; and 'Add a sub-task to the to-do list' pointing to the '+Add Sub-Tasks' button.



## Introduction to the Photo Album Feature

The Photo Album module serves as the family media centre within the Family Collaboration Management Panel, enabling parents to upload photos and videos from their mobile devices (via the vcivik app) to shared devices, where they can be viewed by all family members at any time. It supports both individual and batch uploads of photos, whilst videos can only be uploaded individually; these can be displayed in a loop as a digital photo frame to showcase family memories.

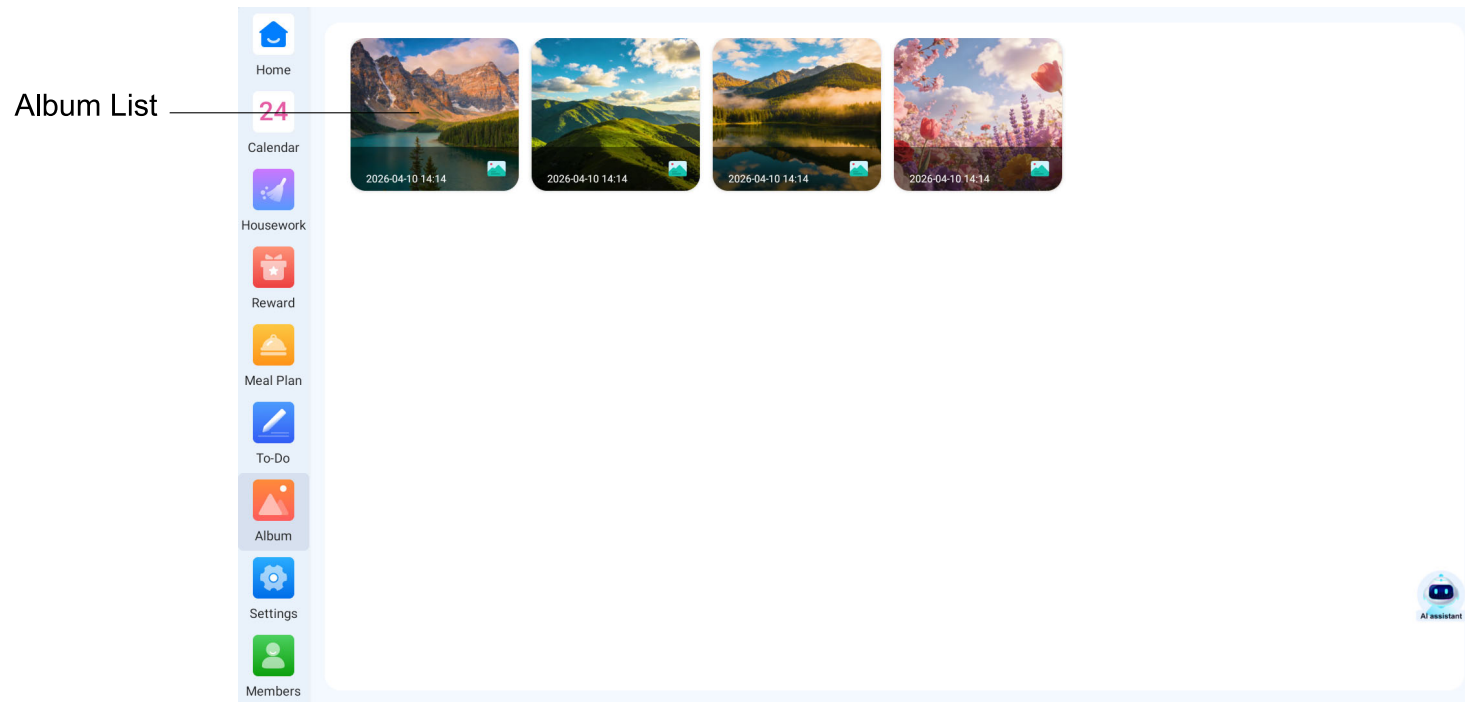



## About the Settings Feature

The Settings module serves as the system configuration hub for the home collaboration management panel, allowing you to manage device networks, general settings, display effects, audio, customisation options for various functional modules, screen savers, and access help and 'About' information. It forms the cornerstone of the smooth operation of your home devices and a personalised user experience.

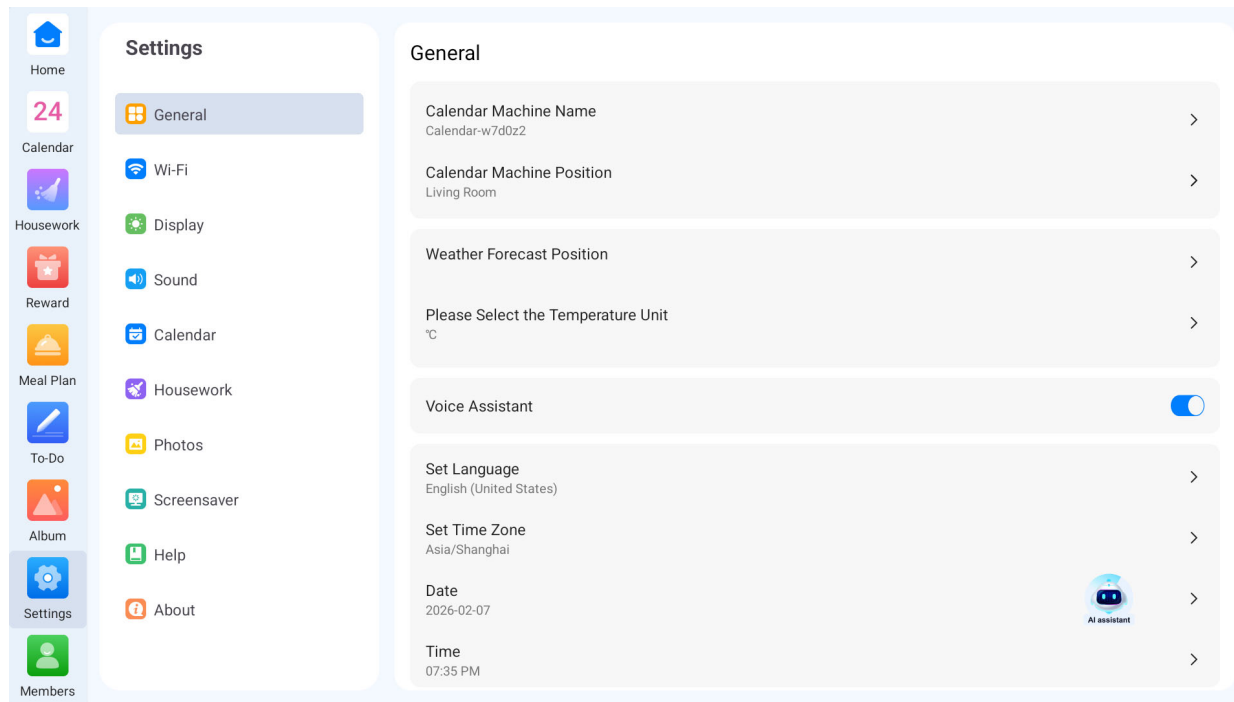



## Introduction to Main Functional Pages on Mobile App:

Smart Creation, Star Assignment, Reward Creation, Catering Plans: Smart Recipe Creation, Synchronized import, Member Management, photo Upload Synchronized import:

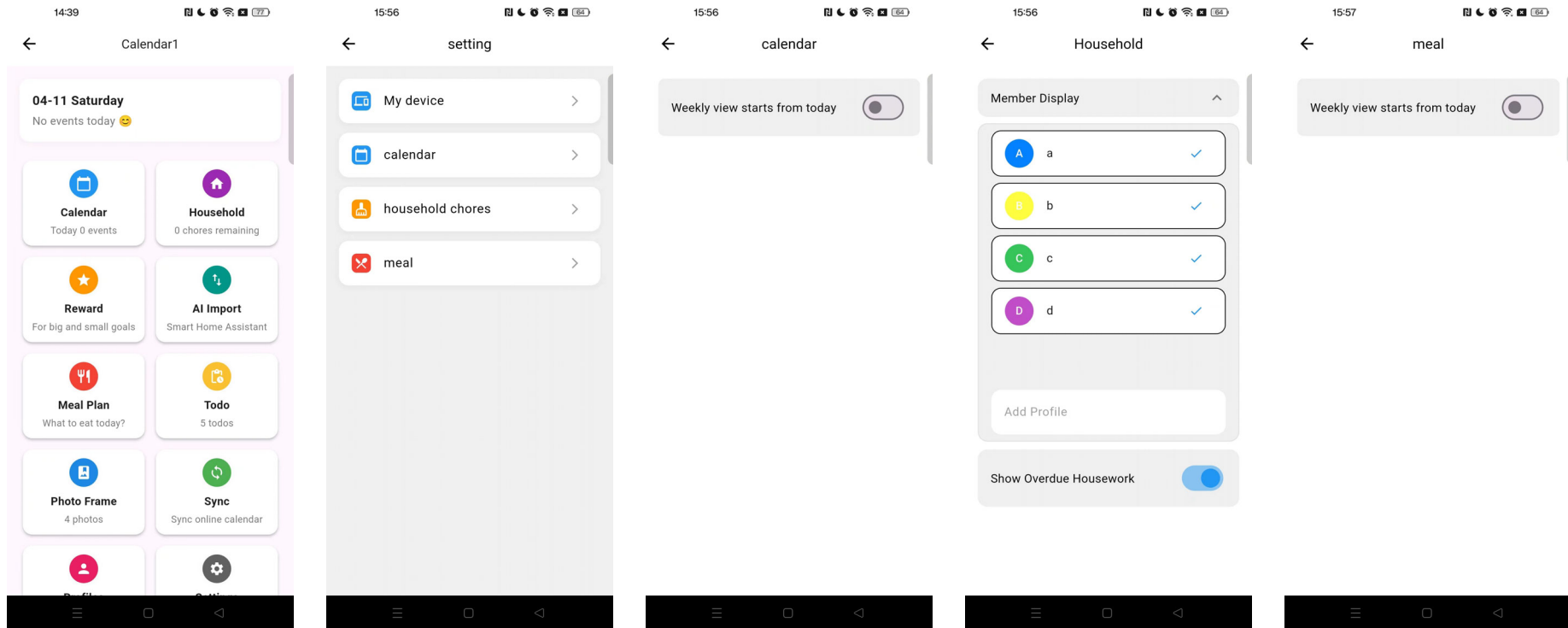



# Introduction to Main Functional Pages on Mobile App:

Smart Creation, Star Assignment, Reward Creation, Catering Plans: Smart Recipe Creation, Synchronized import, Member Management, photo Upload Synchronized import:

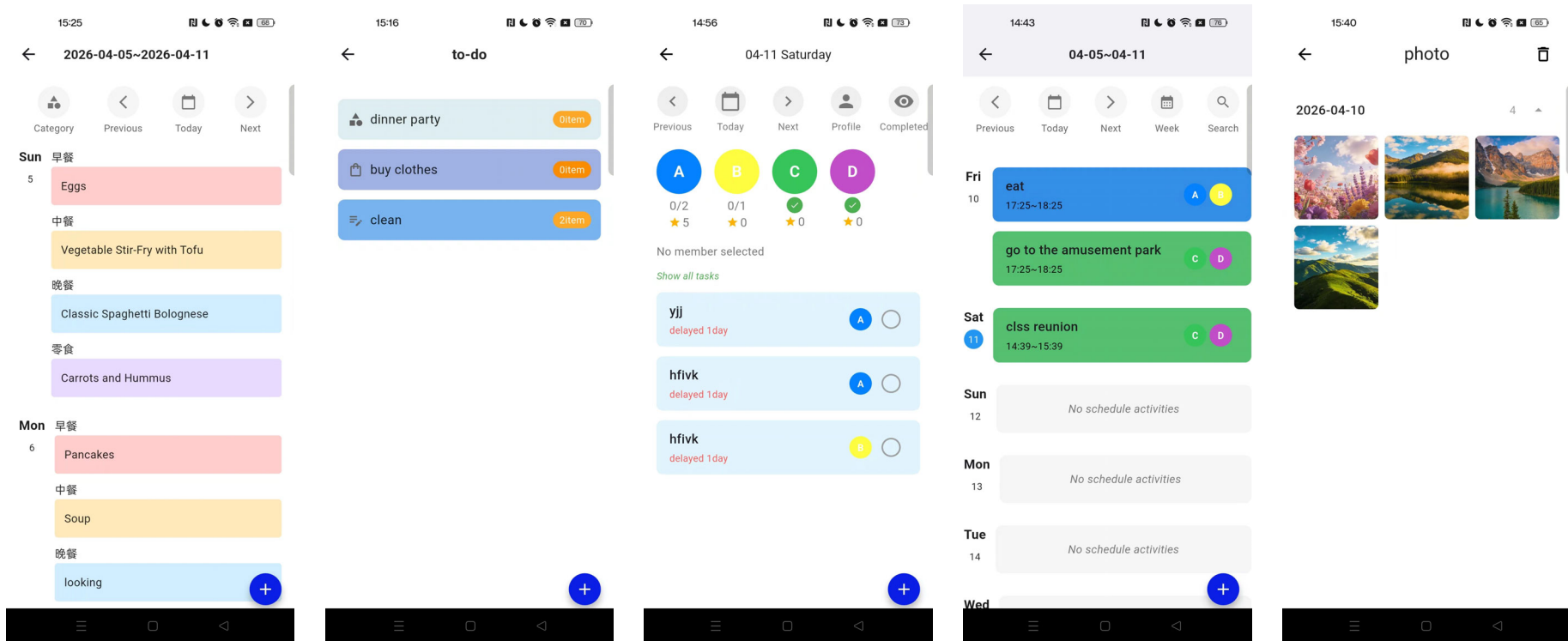



## Star Assignment:

Create rewards and set rules together.

When you have collected enough stars, you can redeem our pre-agreed rewards with them! Rewards can be items or a special experience.

Rewards are created by parents on the mobile app, and children can view their rewards and progress on the device

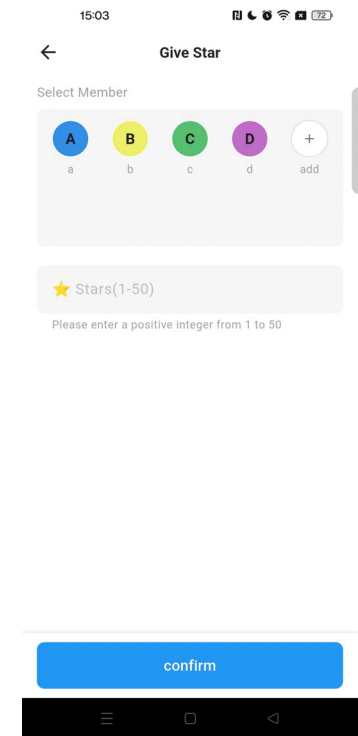
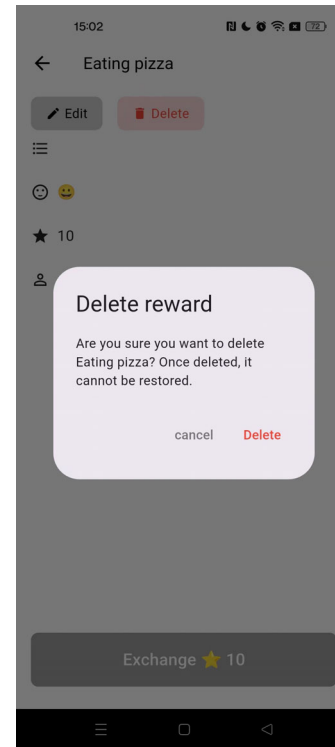
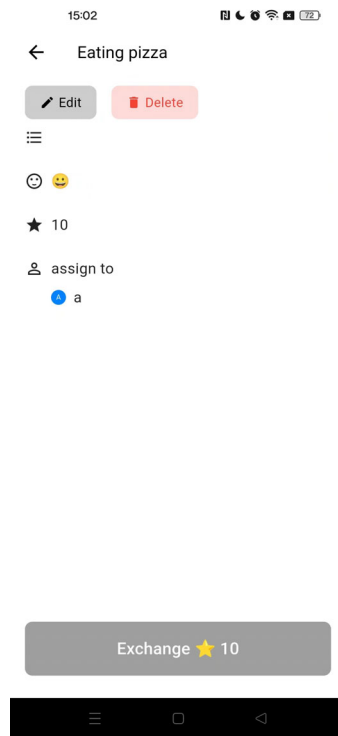
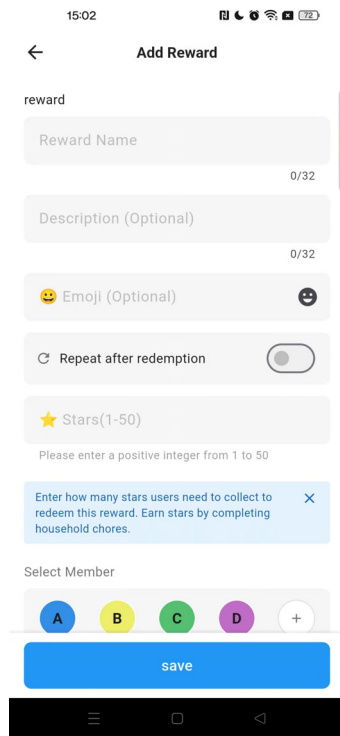
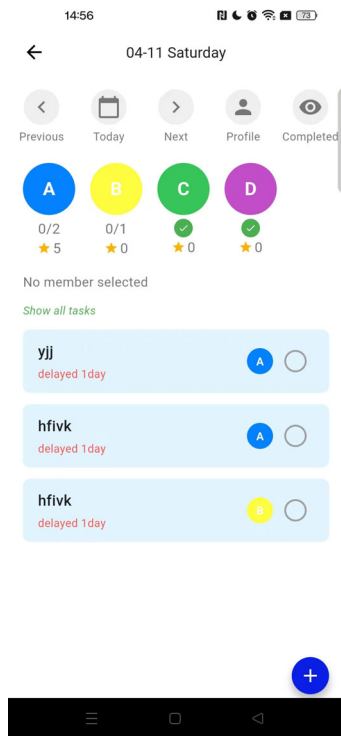



## Factory Reset

Deletes all data from your frame. This will permanently delete all your photos/videos, contacts, and settings.

## Warranty & Contact Us

### Limited One-Year Warranty

We offer a one-year quality warranty on all products, valid from the date of purchase, and subject to the following terms and conditions:

If a quality defect is discovered within the warranty period, the manufacturer is responsible for repairing or replacing the device at no charge to the customer.

This warranty does not apply to damages caused by improper use, accident, exposure to water, or if the product was altered or repaired by anyone other than the Manufacturer's Service Center.

The manufacturer shall not be liable for any incidental or consequential damages arising from the use, misuse, or mounting of the photo frame.

All information in this manual is based on the latest information available at the time of publication. We reserve the right to make changes at any time without notice.



## Help & About

### User guide

Opens the quick start guide that is shown during initial setup of the frame

### Check for Updates

Check for available software updates and download/install them on your frame.

### Feedback

We strive to continuously improve our product and user experience, If you have any questions, comments, or suggestions, please reach out to us by email or through the support feature in the Vcivik app.



## FCC Statement

This equipment has been tested and found to comply with the limits for a Class B digital device, pursuant to Part 15 of the FCC Rules. These limits are designed to provide reasonable protection against harmful interference in a residential installation. This equipment generates, uses, and can radiate radio frequency energy and, if not installed and used in accordance with the instructions, may cause harmful interference to radio communications.

However, there is no guarantee that interference will not occur in a particular installation. If this equipment does cause harmful interference to radio or television reception, which can be determined by turning the equipment off and on, the user is encouraged to try to correct the interference by one or more of the following measures:

Reorient or relocate the receiving antenna.

Increase the separation between the equipment and receiver.

Connect the equipment into an outlet on a circuit different from that to which the receiver is connected.

Consult the dealer or an experienced radio/TV technician for help.

Caution: Any changes or modifications to this device not explicitly approved by the manufacturer could void your authority to operate this equipment.

This device complies with Part 15 of the FCC Rules. Operation is subject to the following two conditions:

- (1) This device may not cause harmful interference, and
- (2) this device must accept any interference received, including interference that may cause undesired operation.



## **RF Exposure Information**

This equipment complies with FCC radiation exposure limits set forth for an uncontrolled environment. This equipment should be installed and operated with minimum distance 20cm between the radiator and your body.

## **DISCLAIMER**

EN: We reserve the right to change product specifications and update this information from time to time.