



Voice Control



Gesture Control



Touch Buttons



Remote Control

Caution!
Make sure the air damper can open freely after the installation.

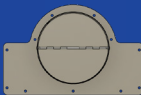

6" Top
Round Adapter



3-1/4" x 10" Top
Rectangular Adapter



3-1/4" x 10" Rear
Rectangular Adapter

* 3 adapters and matching covers are included for your convenience.
* Only 1 adapter should be used in any installation.

*** Unpack & Check for Shipping Damages ***
*** Test Run Before Installation ***

Steps To Test Run Before Installation

IMPORTANT!

Wear gloves to protect against sharp edges.

*Please follow these instructions to **TEST THE RANGE HOOD BEFORE INSTALLATION** for any defect or shipping damage:*

1. Remove the range hood and accessories from the package carefully.
2. Place the range hood on a flat stable surface, remove the baffle filter and check for any dents or damages on the range hood body.
3. Remove the loosen parts if there's any.
4. Plug the range hood into a 120V AC power source. Press the power button once and then any of the speed buttons to turn it on.
5. Check each speed variation and pay attention to the noise level to make sure there isn't any unusual noise besides it coming from the wind blowing. Press the Light Button to check the lights.
6. Verify all functions, as described in Page 11 are working properly.
7. Refer to Range Hood Troubleshooting in Page 16 for general issues and solutions.

Note

The protective films on the body was removed to complete the brush finished polishment on the surface.

Important Safety Instructions	4
Installation Preparations	5
Venting Requirements	5
Venting System Setup	5
Mounting Height Recommendations	5
Electrical Requirement	6
RH-UC6-V Dimensions	7
Installation	8
Installation Option 1 - Top Venting Through The Roof	8
Installation Option 2 - Top Venting Through The Wall	9
Installation Option 3 - Rear Venting Through The Wall	10
Range Hood Operation	11
Manual Operation	11
Voice Control Operation	12
Gesture Control Operation	13
Smart Memory Function	13
Remote Control Operation	14
Range Hood Care	15
Clean the Exterior Surfaces	15
Clean or Replace the Baffle Filters	15
Replace the LED Lamps	15
Range Hood Troubleshooting	16
Warranty	17

IMPORTANT SAFETY INSTRUCTIONS

TO REDUCE THE RISK OF FIRE, ELECTRIC SHOCK OR PERSONAL INJURY, PLEASE READ THE FOLLOWING CAREFULLY BEFORE ATTEMPTING TO ASSEMBLE, INSTALL, OPERATE OR MAINTAIN THE RANGE HOOD:

- Always disconnect, lock and tag the power source before installing or servicing the range hood. Failure to do so may result in fire, shock or serious injury.
- Installation and electrical wiring must be done by qualified technician(s) in accordance with all applicable codes and standards, including fire-rated construction.
- When cutting or drilling into walls or ceilings, please be careful not to damage any electrical wirings and other hidden utilities.
- Verify and ensure the rated voltage and frequency of the range hood is in compliance with the nearby power source.
- Always unplug the range hood from the power source before cleaning it.
- Use the range hood only as directed in this manual. Do not use it to vent hazardous or explosive materials or vapors.
- Clean the baffle filters regularly to prevent it become blocked or clogged. Good air flow is essential for the range hood to work properly.
- Do not install, repair or replace any parts of the range hood unless you are instructed to do so by the manufacturer.
- Do not tamper with or modify the PCB.
- This range hood model requires a duct to vent the air outside. Do not vent the air into spaces within walls, ceilings, attics, crawl spaces or garages.

TO REDUCE THE RISK OF A RANGE TOP GREASE FIRE:

- Never leave surface units unattended at high settings. Boilovers cause smoking and greasy spillovers that may ignite. Heat oils slowly on

low or medium settings.

- Always turn the hood ON when cooking at high heat or when flambing food (i.e. Crepes Suzette, Cherries Jubilee, Peppercorn Beef Flambé).
- Clean ventilating fans frequently. Grease should not be allowed to accumulate on the fan or filter.
- Use proper pan sizes. Always use cookware appropriate for the size of the surface element.

TO REDUCE THE RISK OF INJURY TO PERSONS IN THE EVENT OF A RANGE TOP GREASE FIRE:

- **SMOTHER FLAMES** with a close-fitting lid, cookie sheet or metal tray, then turn off the burner. **BE CAREFUL TO PREVENT BURNS.** If the flames do not go out immediately, **EVACUATE AND CALL THE FIRE DEPARTMENT.**
- **NEVER PICK UP A FLAMING PAN** - you may be burned.
- **DO NOT USE WATER**, including wet dish cloths or towels - a violent steam explosion may result.
- Use a fire extinguisher **ONLY** if:
 - You have a Class ABC extinguisher, and you already know how to operate it.
 - The fire is small and contained in the area where it started.
 - The fire department is being called.
 - You can fight the fire with your back to an exit.

TO REDUCE THE RISK OF PERSONAL INJURY IN THE EVENT OF A GAS LEAK:

- Extinguish any open flame.
- **DO NOT** turn on the lights or any type of appliance.
- Open all doors and windows to disperse the gas. If you still smell the gas, call the gas company, fire department, or 911 immediately.

Read and Save These Instructions

INSTALLATION PREPARATIONS

Venting Requirements

DO

- Have the venting system go vertically from the range hood to the roof if possible.
- Have 24"-30" distance between the cooktop and the range hood. 27" is recommended.
- Use uniformed 6" round duct for 6" Round Adaptor or 3-1/4" x 10" rectangular duct or larger.
- Use metal vent only. Rigid metal vent is recommended. Semi-rigid aluminum duct is subject to your local buiding code requirement.
- Make sure there is a minimum of 24" of straight vent between the elbows if more than 1 elbow is used.
- Use minimal numbers of elbows and the shortest route for the venting system for a better performance.
- Use silver tap or duct tap to seal all joints in the venting system.
- Use caulking silicone to seal exterior wall or roof opening around the cap.
- Always keep the duct clean to ensure proper airflow

Mounting Height Recommendations:

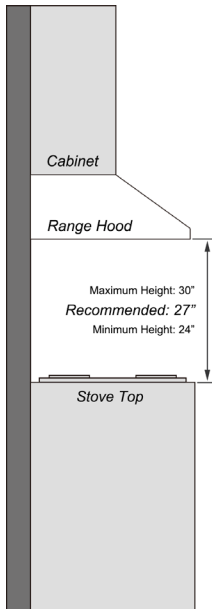

DO NOT

- End the venting system in an enclosed area indoors.
- Use plastic vent.
- Use no more than three 90° elbows.
- Install 2 elbows together.
- Install the range hood outside of the recommended height.
- Reduce the duct size below the recommended size.

Note

- *It is important to install the range hood at the proper mounting height. Hoods mounted too low could result in heat damage and fire hazard while hoods mounted too high will be out of reach and hense reduce its performance and efficiency.*

Venting System Setup

- This Range Hood can either be 6" round or 3-1/4" x 10" rectangular top venting through the roof or wall, or 3-1/4" x 10" rectangular rear venting through the wall.

Top Venting Roof Exhaust

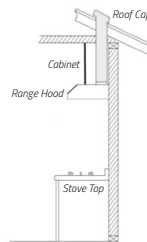

Top Venting Wall Exhaust

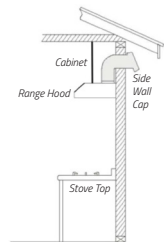

Rear Venting Wall Exhaust

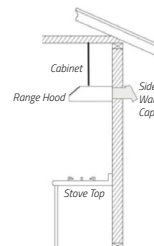

INSTALLATION PREPARATIONS

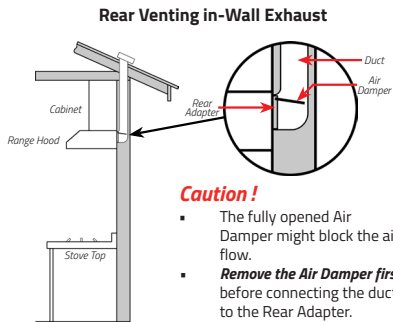

IMPORTANT!

- If long duct run is needed, increase the duct size from 6" to 7".
- If a reducer is needed, use a long reducer instead of a pancake reducer and install it as far away from the range hood as possible. Reducing the duct size will restrict and decrease the speed of the airflow and hence lower the range hood's performance.
- If transitions or turns are needed, install them as far away from the range hood as possible and keep the distance between them as far apart as possible.
- Also refer to the owner's manual of the stove top for the height clearance requirement and the recommended mounting height above the range.

Minimum Duct Size:

- **Round:** 6" minimum.
- **Rectangular:** 3-1/4" x 10" minimum.

Make sure all the ducts and vent out adapters meet the minimum sizes. Avoid 4" or 5" in any sections.

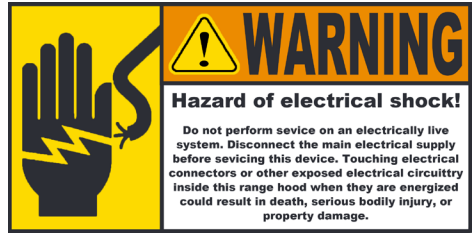

IMPORTANT!

Observe all governing codes and ordinances.

It is the customer's responsibility:

- To contact a qualified electrical installer;
- To ensure that the electrical installation is in compliance with applicable codes and standards.

Electrical Requirements:

- A 120V, 60Hz., AC only, 3A fused electrical circuit is required.
- Wire sizes and connections must conform with the power rating of the range hood and all applicable codes and standards.
- DO NOT have a fuse in the neutral or ground circuit.
- The 3-prong outlet should be grounded. If the power cord plug is not used, the power cord's green wire should be connected to ground. Check with a qualified electrician if you are not sure that the range hood is properly grounded.
- DO NOT ground to a gas pipe.
- The range hood must be connected with copper wire/plug only.
- The range hood should be connected directly to the fused disconnect box (or circuit breaker) through flexible armored or non-metallic sheathed copper cable. ETL listed strain relief must be provided at each end of the power supply cable.

RH-UC6-V Dimensions

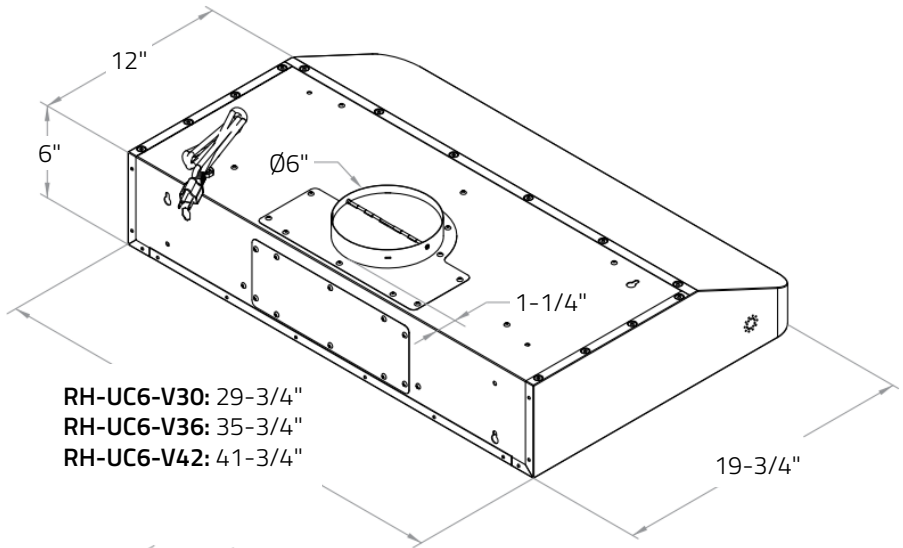

- RH-UC6-V30: 29-3/4"
- RH-UC6-V36: 35-3/4"
- RH-UC6-V42: 41-3/4"

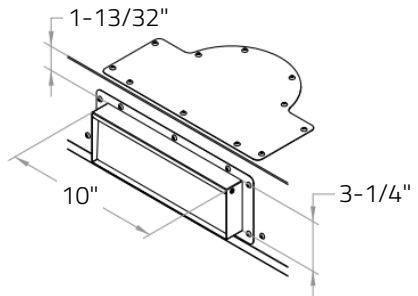
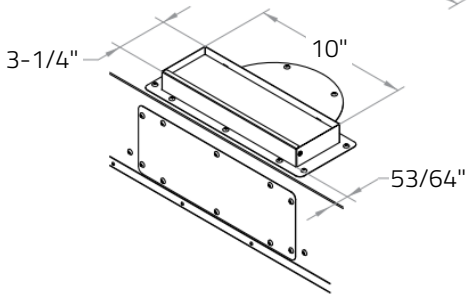

Installation Option 1 - Top Venting Through The Roof

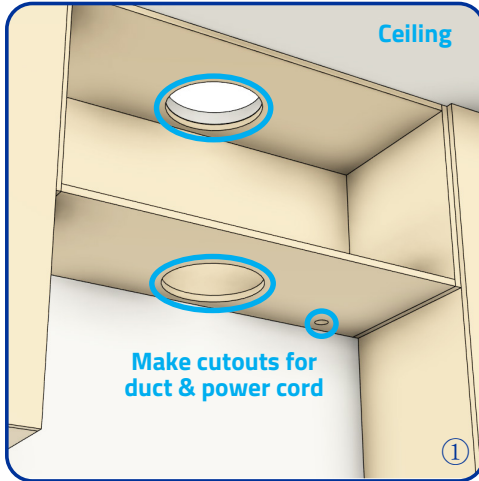

Measure and make cutouts for the duct and power cord on the cabinet and the ceiling.

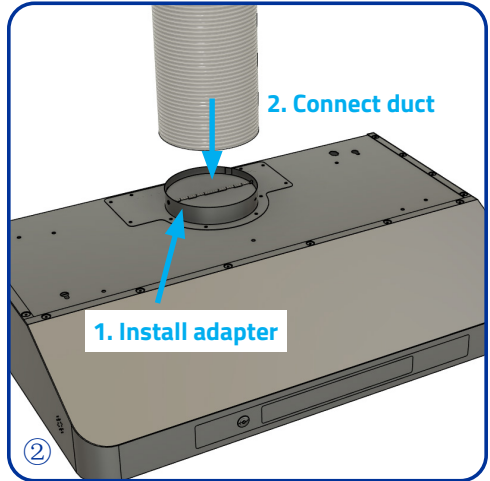

- Install the top adapter.
- Connect the duct and seal the connection.

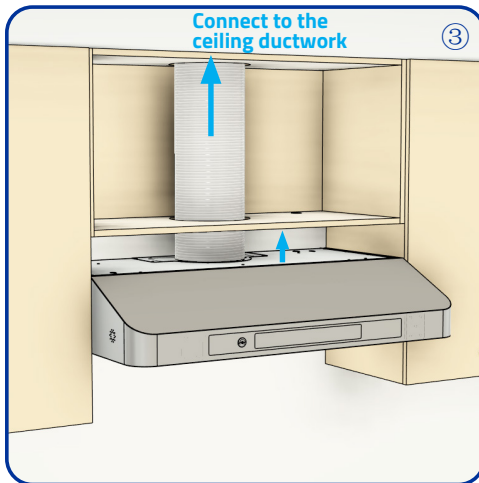

Raise the hood and guide the duct through the cutouts.

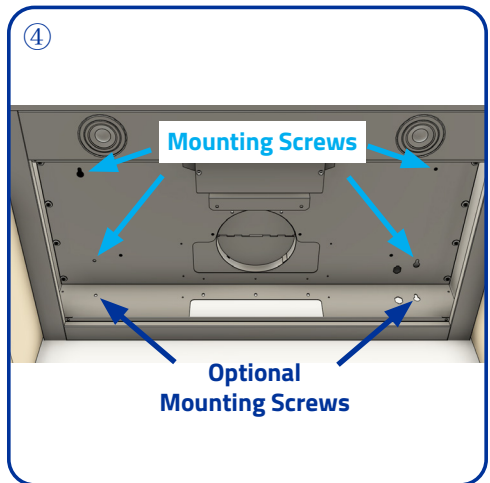

Install the range hood to the bottom of the cabinet.

Installation Option 2 - Top Venting Through The Wall

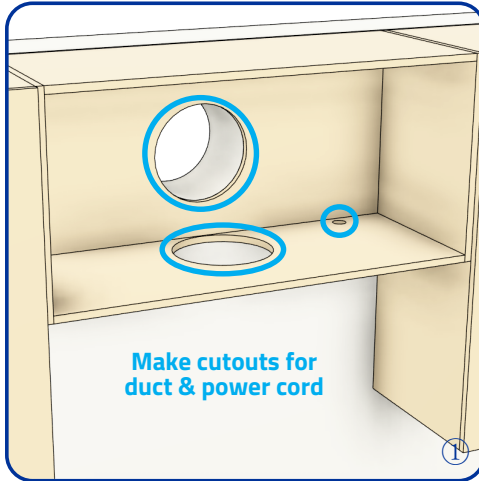

Measure and make cutouts for the duct and power cord on the cabinet and the wall.

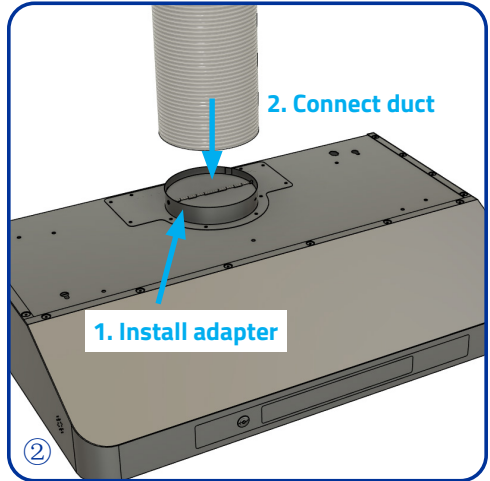

- Install the top adapter.
- Connect the duct and seal the connection.

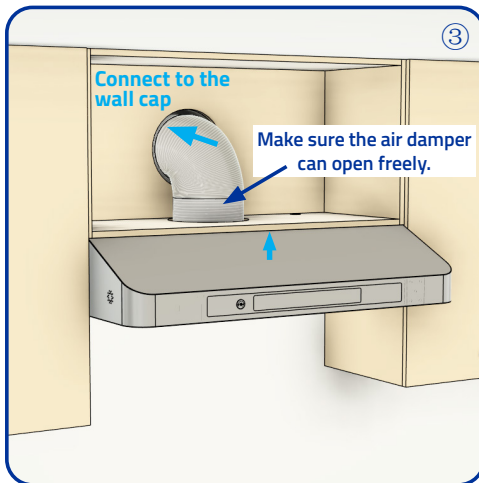

Raise the hood and guide the duct through the cutouts.

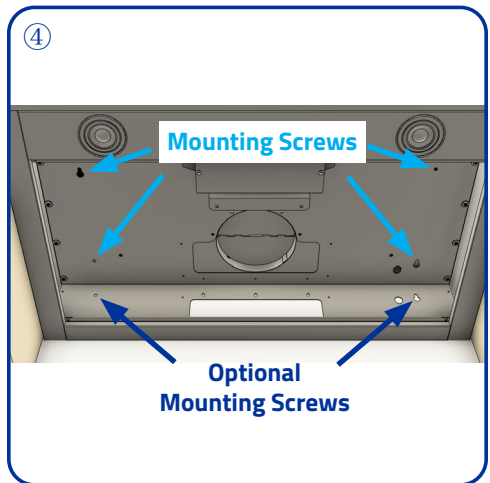

Install the range hood to the bottom of the cabinet.

Installation Option 3 - Rear Venting Through The Wall

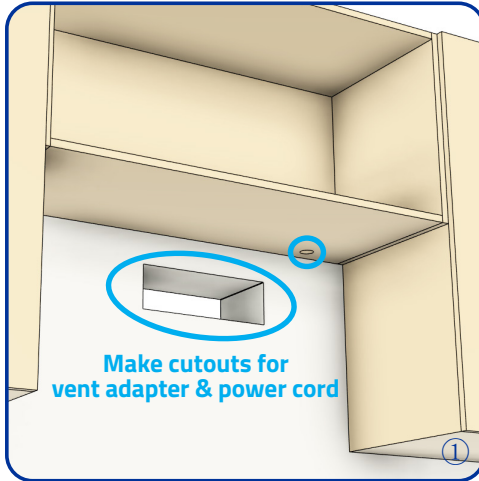

Measure and make cutouts for the duct and power cord on the cabinet and the wall.

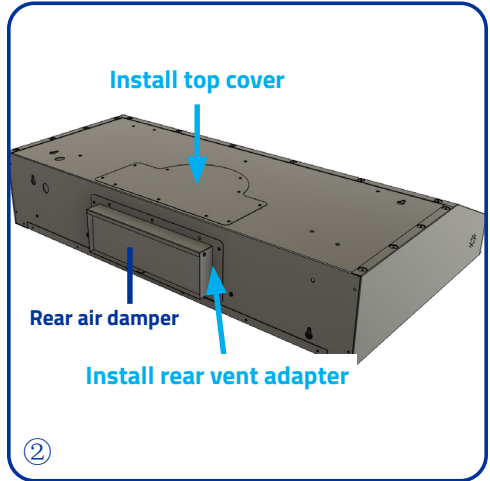

- Install the rear vent adapter & the top cover.
- Remove the rear air damper if it's blocking the air flow.

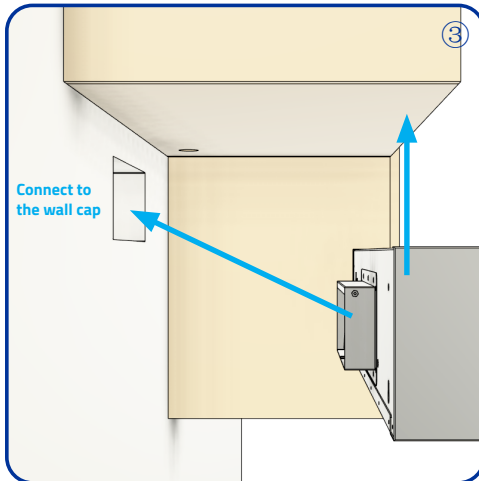

Raise the hood and guide the rear vent adapter through the cutouts.

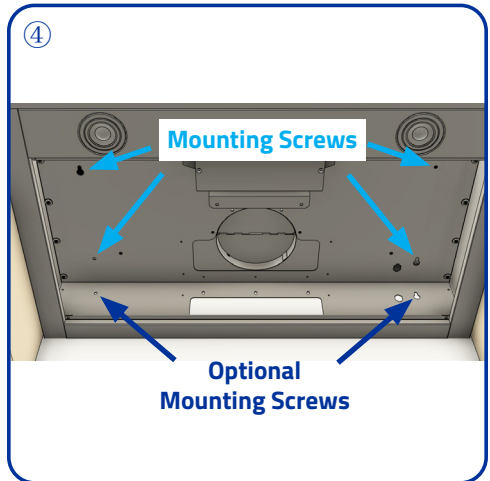

Install the range hood to the bottom of the cabinet.

RANGE HOOD OPERATION

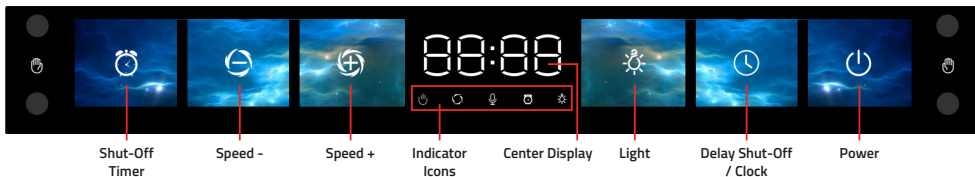

MANUAL OPERATION

Control Panel Touch Buttons (From Right To Left)



Power

- When the range hood is OFF, touch the power button once will turn on the range hood. Set the speed to F0 to put it into **Standby Mode**. Now the range hood is ready for additional operation inputs.
- While in standby mode, touching the power button will turn off the range hood immediately.
- While the range hood is OFF, touch and hold the power button for 3 seconds to activate/deactivate the Gesture Control function.

Delay Shut-Off / Clock

- While the range hood is running at any speed, touch this button to activate the Delayed Auto Shut-Off function.
- When the Delayed Auto Shut-Off function is activated, this button will begin to flash and the center display will show a default 5-minute countdown timer.
- The indicator icon  for the Delayed Auto Shut-Off function will also light up, indicating the Delayed Auto Shut-Off function is activated.
- When the countdown timer is present, changing the range hood speed will cancel the countdown timer and resume the range hood into normal operation.
- When the countdown timer reaches 0, it will shut off the range hood fans and the lamps.

How To Set The Clock

- When the range hood is on **Standby Mode** (power on the hood and decrease the speed to F0), touch and hold the Delayed Shut-Off/Clock button  for 5 seconds to enter the time adjustment mode. The Hour indicator will flash.
- Use the Speed + or Speed - button to adjust the hour to the correct one. The Hour can be adjusted from 1 to 12.
- When done setting the Hour, touch the Delayed Shut-Off/Clock button  once and the Minute indicator will flash.
- Use the Speed + or Speed - button to adjust the minute to the correct one. The Minute can be adjusted from 00 to 59.
- When done setting Minute, touch the Delayed Shut-Off/Clock button  once to save the inputs. The clock is now set up and will be shown in the center display when the range hood is not running.

Light

- When the range hood is on and the light button is touched for the first time, it will turn on the lamps at the maximum light level.

- When the lamps are on, touch and hold the light button to adjust the lighting level steplessly. The lamps will begin to dim, and when they reach the minimum lighting level (16%), they will become brighter and brighter until they reach the maximum lighting level, then they will begin to dim again till the minimum lighting level, so on and so forth.
- When the lamps are on, the indicator icon  also lights up.

Speed + & Speed -

Speed +

- When the range hood is on standby mode, touching the Speed + button will set the range hood to speed 2 (F2). F2 will be shown in the center display. Each following consecutive touch of the button will increase the speed by 1, until it reaches the maximum speed 4 (F4).
- When the range hood is running at any speed below speed 4 (F4), touching the Speed + button will increase the speed by 1, until it reaches the maximum speed 4 (F4).

Speed -



- When the range hood is on standby mode, touching the Speed - button will set the range hood to speed 1 (F1).
- When the range hood is running at speed 1 (F1), touching the Speed - button will turn off the motors.
- When the range hood is on standby mode, touch and hold the Speed - button for 3 seconds to enable/disable the Voice Control function.
- The center display will show the current speed (Min. F1, Max F4).

Shut-Off Timer



- When the range hood is running, touching this button will start a countdown timer to shut off the range hood. The default duration is 15 minutes. It can be adjusted to minimum 1 minute with the Speed - button or maximum 30 minutes with the Speed + button.
- When the countdown timer is active, changing the range hood speed will cancel the countdown timer and resume the range hood into normal operation.
- When the countdown timer is set, the indicator icon  also lights up.

VOICE CONTROL OPERATION

How To Enable/Disable Voice Control

- **Using the control panel button**
 - When the range hood is on standby mode, touch and hold the Speed (-)  button for 3 seconds.
- **Using the remote control**
 - When the range hood is on standby mode, press and hold the (-)  button for 3 seconds.



Wake Up Phrase

- When the Voice Control function is activated and the wake up phrase "Hi Awoco" is said, the range hood will respond with "Hi, I'm here." and begin to listen to the voice commands. The indicator icon  also lights up.
- When there's no voice command input within 15 seconds from the last voice command, the range hood will say "See you later" and stop listening to the voice commands. The indicator icon  will go out. From here on, the wake up phrase "Hi Awoco" must be said before the range hood can accept any additional voice commands.

Voice Command	Respond	Result
"Hi Awoco"	"Hi, I'm here."	Wake up Phrase, the range hood is ready to accept voice commands.
"Power on"	"OK, it is on."	Power on the range hood.
"Speed 1/2/3/4"	"OK, speed 1/2/3/4"	Change the speed to the corresponding speed level in the voice command
"Lights on/off"	"OK, lights on/off."	Turn lights on/off.
"Power off"	"OK, goodbye"	The range hood shuts off all motors, and enters standby mode, ready to be woke up by the Wake Up Command.
"Higher speed"	"OK, speed 1/2/3/4"	Increase the speed level by 1. F0 to F1... F3 to F4
"Lower speed"	"OK, speed 3/2/1"	Decrease the speed level by 1. F4 to F3 ... F2 to F1
"Lower speed" at F1	"OK, motor off"	Motors are turned off.
"Higher speed" at F4	"OK, speed 4"	The speed level will stay at the maximum speed F4
No voice input within 15 seconds	"See you later"	No longer listening. Need to wake up the range hood with the Wake Up Phrase.
"Delay shutdown"	"OK, shutdown 5 minutes later"	A default 5-minute countdown timer will show up in the Time/Speed Display. Increasing or decreasing the speed level will cancel the timer and resume the range hood into working order at the selected speed.

GESTURE CONTROL OPERATION

How To Enable/Disable Gesture Control

- **Using The Control Panel Button**
 - When the range hood is **OFF**, touch and hold the Power button  for 3 seconds.
- **Using The Remote Control**
 - When the range hood is **OFF**, press the "Hand" button  once.

Hand Gestures

- The optimal distant for the hand gestures to work best is 3 to 4 inches away from the control panel.
- Move the hand across the left and right sensors in a short time for the gesture control to determine if it is a left-to-right or right-to-left command..
- **Swiping From Left To Right**
 - Every time the range hood is shut off, it memorizes the speed level and lighting level at the time of shutting off and store the info into the buffer memory, unless there's a power outage. **Swiping From Left To Right** will turn on the range hood and resume it to the previous speed level and lighting level from the buffer memory.
 - When the range hood is running at any speed that is below speed 4 (F4), **Swiping From Left To Right** will increase the speed level by 1, up to max speed 4 (F4). Continuing to swipe from left to right when at speed 4 (F4) will no longer increase the speed level.
- **Swiping From Right To Left**
 - When the range hood is running at any speed that is above speed 1 (F1), **Swiping From Right To Left** will decrease the speed level by 1.
 - When the range hood is running at speed 1 (F1), **Swiping From Right To Left** will turn off the motors. If the lamps are on, **Swipe From Right To Left** again to turn off the lamps.

SMART MEMORY FUNCTION

- This range hood will memorize the speed level and lighting level at the time it is shut off and store the info into the built-in buffer memory. Such info will then be used to resume the range hood into operation the next time the range hood is powered on.

Warning !

- If the range hood is unplugged from the wall power outlet, or there's a power outage:
 - The stored info will be lost!
 - The clock for current time will be reset to the default value. You will need to set the time again.

REMOTE CONTROL OPERATION

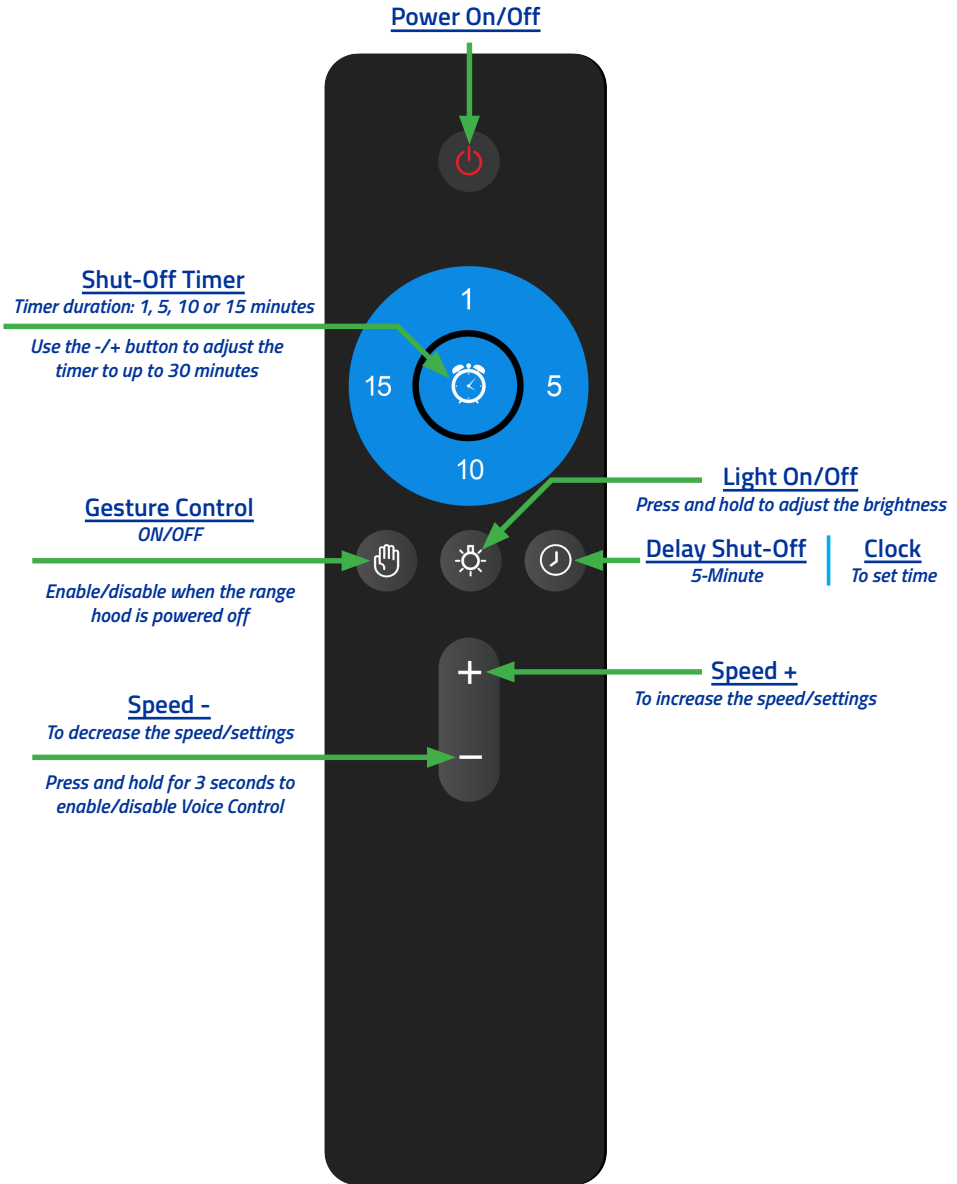

IMPORTANT!

- The remote requires 2x AAA batteries to operate.
- Batteries not included. Must be purchased separately.

RANGE HOOD CARE

Cleaning

WARNING

- To reduce the risk of electrical shock, DO NOT clean the hood while it's operating.
- Never put your hands into the area housing the fan when the fan is operating.

Cleaning the Exterior Surfaces

IMPORTANT !

To avoid damage to the exterior surfaces:

- DO NOT use corrosive or abrasive detergent.
- DO NOT use steel wool, scoring pad or steel brushes. Use a paper towel or soft cloth or nonabrasive sponge instead.
- DO NOT use salt solutions, disinfectants, bleaches or cleaning compound that contains harmful chemicals.

Cleaning Method

- Noncorrosive or nonabrasive liquid detergent soap or all-purpose liquid cleanser.
- Wipe the surfaces with a damp paper towel or soft cloth or nonabrasive sponge.
- Rinse with clean water.
- Wipe dry with dry towel or cloth.

Note

- The nonabrasive stainless steel polisher can be applied when done cleaning to retain the stainless luster and grain.
- Always follow the instruction of the polisher.

Cleaning the Stainless Steel Baffle Filters

- Pull the spring release handle and remove the filter by pulling it down.
- Wash the filter in the top rack of the dishwasher or with warm soapy solution manually.
- Let the filters dry thoroughly.
- Make sure the spring release handle is toward the front, align and insert the filter.
- Pull the spring release handle and push the filter into position.
- Release the handle.
- Repeat the steps for the remaining filters.

Replacing the Filters

- Replace the baffle filters immediately should they become worn out due to aging or prolonged usage.

Replacing the LED Lamps

WARNING

Electrical Shock Hazard

Disconnect power before servicing

Wear gloves to protect against sharp edges

- This range hood uses two 12V DC, 3W LED lamps.
- Unplug the range hood, or turn off the breaker.
- Remove the baffle filters.
- Locate and unplug the power connectors that connect the LED lamp to the circuitboard.
- Take out the old lamp.
- Install the new lamp and connect the power connectors.
- Put the baffle filters back into place.
- Plug in the range hood or turn on the breaker.
- Turn on the light and check if the new lamp is working properly.

RANGE HOOD TROUBLESHOOTING

Before Calling for Service

Issue	Possible Cause / Solution
The range hood doesn't turn on	<ul style="list-style-type: none"> Check if the range hood is plugged in. Make sure that all power is turned ON and all electrical wirings are properly connected.
The range hood turns on but the LED light doesn't	<ul style="list-style-type: none"> Check the LED light cable connectors, disconnect and reconnect the cable connectors. Replace the defective LED assembly. Refer to Range Hood Care section for instructions.
The range hood vibrates when the blower is on	<ul style="list-style-type: none"> Check and tighten the mounting screws to secure the hood to the cabinet or wall properly. Check if the fan wheel is tighten to the motor shaft. Check if the fan wheel is unbalanced.
The blower or fan seems weak	<ul style="list-style-type: none"> Check that the duct size used is at least 6" and does not have sections with smaller sizes between the hood and the Roof/Wall Cap. Range hood WILL NOT function efficiently with insufficient duct size. For example: 4" ducts or 4" vent out adapter is in used. Check if the duct is clogged or the damper (half-circular flapper) is not installed correctly or opening properly. A tight mesh on a side wall cap might also cause restriction to the air flow.
The lights work but the blower is not spinning at all or is rattling	<ul style="list-style-type: none"> The blower might be jammed or scraping the bottom due to shipping damage. Disconnect the power cord, remove the fan grill and the fan blade, might see the fan blade or/and motor is not in the proper position (offset from the center). Try to fix/adjust it or please contact us immediately.
The hood is not venting out properly	<ul style="list-style-type: none"> Make sure the air damper can open freely. Make sure the distance between the stove top and the bottom of the hood is within recommended 24" and 30" in distance. *Due to different ceiling height configurations, the recommended height may not be applicable. Reduce the number of elbows and length of duct work. Check if all joints are properly connected, taped and sealed. Make sure the power is on high speed for heavy cooking.

WARRANTY

This product is warranted for a limited period of **ONE YEAR Parts, begins from the date of purchase.**

This limited warranty is applied to the original retail purchaser and valid only for products purchased for home use in the continental United States of America.

This limited warranty is non-transferable and does not extend to the subsequent owners of this product.

Any applicable implied warranties, including the warranty of merchantability, are limited in duration to a period of express warranty as provided herein beginning with the date of original purchase at retail and, no warranties, whether express or implied, shall apply to this product thereafter.

In the event of the product fail to work properly due to a defect in manufacturing materials or workmanship under normal home use, during the warranty period mentioned above, subject to the conditions and limitations set forth below, Awoco will, at our options, either repair or replace any part of our products proven defective by reason of improper materials or workmanship:

- Proof of original retail purchase is required to receive warranty service within the limited warranty period.
- Repair parts or replacement products will be provided by Awoco, free of charge, on an exchange basis, and will be either new or reconditioned.

This Limited Warranty Does Not Cover:

- Consumable parts such as light bulbs, stainless steel baffle filters.
- The natural wear of finish, and wear due to improper maintenance, use of corrosive and abrasive cleaning products, pads, and oven cleaner products.
- Chips, dents or cracks on the product caused by transportation and handling.
- Damage of product caused by accidents, pests and vermin, lightning, wind, fire, floods or acts of God.

- Damage of product caused by unauthorized modification or alteration, or if it is used for other than the intended purpose, or any water leakage where the unit was not installed properly.
- Damage of product caused by incorrect electrical wiring, commercial or industrial use, or use of any cleaning products not recommended in this manual.
- Damage of product due to product misuse, abuse, improper installation, unauthorized repair or maintenance.
- Any loss of properties or any costs associated with removing, servicing, installing, or determining the source of problems with our products.

To Receive Warranty Service:

- Contact the seller or distributor from which you purchase the product. Please confirm the terms of your dealer's or distributor's policies prior to contacting. Or contact us directly.
- Provide the product identification information, such as model number and lot number, and proof of original purchase.
- Describe the issue you are experiencing in detail.

Product Support and Additional Information:

If you need assistance using your product or you would like to start the warranty service:

- Contact us at 1-626-522-9688, between 10 AM and 5 PM, Monday - Friday, Pacific Time.
Or
- Email us at sales@awoco.com.



Website: www.awoco.com Customer Support: 1-626-522-9688
Email: sales@awoco.com