

705-6852FC-00

Godox

TT685 II (F)

THINKLITE TTL CAMERA FLASH

迅丽 TTL 机顶闪光灯



说明书
Instruction Manual

深圳市神牛摄影器材有限公司

地址: 深圳市宝安区福海街道塘尾社区耀川工业区厂南2栋

电话: 0755-29609320(8062) 传真: 0755-25723423 邮箱: godox@godox.com

GODOX Photo Equipment Co., Ltd.

Add: Building 2, Yaochuan Industrial Zone, Tangwei Community, Fuhai Street, Bao'an District, Shenzhen, 518103 China Tel: +86-755-29609320(8062)

Fax: +86-755-25723423 E-mail: godox@godox.com

godox.com Made in China



在使用本产品之前:

请先仔细阅读本手册, 以确保您能安全使用。请保存好本手册以备将来查询参考。

Before using this product:

Please read this user manual carefully in order to ensure your safety and the proper operation of this product. Keep for future reference.

固件升级

- 本产品USB接口为Type-C接口, 请使用Type-C USB线。
- 产品升级固件需要Godox G3程序软件支持, 升级固件前请先下载安装“Godox G3固件升级软件”再选择相应的固件文件。
- 由于产品进行固件升级, 说明书请以最新电子版为准。

兼容相机列表

根据富士相机对闪光灯控制不同, 分为以下类别进行区分:

A类	X-PRO2、X-T20、x-T2、X-T1、GFX50S、GFX50R、X-T30、X-T4、X-T3
B类	X-Pro1、X-T10、X-E1、X-A3
C类	X100F、X100T

相机兼容及功能支持对照表:

相机	机顶闪光灯						2.4G主控从属闪光灯					
	TTL闪光控制		M闪光控制		重复	TTL闪光控制		M闪光控制		重复		
	标准	REAR	HSS(FP)	标准	REAR	HSS(FP)	闪光	标准	REAR	HSS(FP)	闪光	
A类	√	√	√	√	√	√	√	√	√	√	√	
B类	√	--	--	√	--	--	√	√	--	--	√	
C类	√	√	√	√	√	√	√	√	--	√	--	
	AF辅助对焦灯											
A类	√											
B类	--											
C类	--											

- 注: 1.X100T无后帘(REAR)功能;
2.AF辅助对焦灯在快门低速(<200)时可点亮。

- 此表格仅列举目前已测试的相机型号, 未涵盖所有富士系列相机。其他相机型号, 用户可自行测试。
● 本公司保留未来修改此表格内容的权利。

维护保养

- 闪光灯在工作时, 如发现异常, 应立即关掉电源, 查明原因。
- 灯体应避免震动, 平时注意表面除尘。
- 灯体稍有发热为正常现象, 无特别需要时, 勿连续引闪。
- 闪光灯的所有维修概由本厂指定可供原厂配件之维修部负责。
- 1年保修, 消耗品如灯管等, 不在1年保修范围。
- 经发现, 擅自检修此闪光灯的, 将取消闪光灯之一年保修期, 维修需要收取相关费用。
- 如果本品出现故障或者被水淋湿, 在专业人员维修后方可继续使用。
- 如有技术更改, 恕不另行通知。

Foreword

Thank you for purchasing this product.

This TT685IF camera flash applies to FUJIFILM series cameras and is compatible with TTL autoflash. With this TTL compatible flash, your shooting will become simpler. You can easily achieve a correct flash exposure even in complex light-changing environments. This camera flash features:

- Approx. GN60 (ISO 100, @200mm), 81 steps from 1/1 to 1/256.
- Fully support FUJIFILM TTL camera flash. Workable as Transmitter or Receiver unit in a wireless flash group.
- Use dot-matrix LCD panel to make clear and convenient operations.
- With built-in 2.4GHz wireless remote system to support transmitting and receiving.
- Provided multiple functions, include HSS (up to 1/8000s), FEC, FEB, etc.
- Stable consistency and color temperature with good even lighting.
- Support with firmware upgrade.

⚠ Warning

- ⚠ Always keep this product dry. Do not use in rain or in damp conditions.
- ⚠ Do not disassemble. Should repairs become necessary, this product must be sent to an authorized maintenance center.
- ⚠ Keep out of reach of children.
Stop using this product if it breaks open due to extrusion, falling or strong hit. Otherwise, electric shock may occur if you touch the electronic parts inside it.
- ⚠ Do not fire the flash directly into the eyes (especially those of babies) within short distances. Otherwise visual impairment may occur.
- ⚠ Do not use the flash unit in the presence of flammable gases, chemicals and other similar materials. In certain circumstance, these materials may be sensitive to the strong light emitting from this flash unit and fire or electromagnetic interference may result.
- ⚠ Do not leave or store the flash unit if the ambient temperature reads over 50°C. Otherwise the electronic parts may be damaged.
- ⚠ Turn off the flash unit immediately in the event of malfunction.

Conventions used in this Manual

- This manual is based on the assumption that both the camera and camera flash's power switches are powered on.
- Reference page numbers are indicated by "p.*".
- The following alert symbols are used in this manual:
 - ⚠ The Caution symbol indicates a warning to prevent shooting problem.
 - ℹ The Note symbol gives supplemental information.

Contents

- 22 Foreword
- 22 Warning
- 24 Name of Parts
 - Body
 - Control Panel
 - LCD Panel
 - LCD Panel in Three Modes
 - What's in the Box of TT685IIF Kit?
 - Separately Sold Accessories
 - Loading and Unloading the Battery
- 27 Attaching to a Camera
- 27 Power Management
- 28 Flash Mode – TTL Autoflash
 - FEC (Flash Exposure Compensation)
 - High-Speed Sync
 - Second-Curtain Sync
- 29 M: Manual Flash
- 30 Multi: Stroboscopic Flash
- 32 Wireless Flash Shooting: Radio (2.4G) Transmission
 - Wireless Settings
 - Setting the Communication Channel
 - Wireless ID Settings
 - Scan the Spare Channel
 - TTL: Fully Automatic Wireless Flash Shooting
 - M: Wireless Flash Shooting with Manual Flash
 - Multi: Wireless Flash Shooting with Manual Flash
- 37 Other Applications
 - Sync Triggering
 - Auto Focus Assist Beam
 - Bounce Flash
 - ZOOM: Setting the Flash Coverage
 - Low Battery Warning
- 39 C.Fn: Setting Custom Functions
- 40 Protection Function
- 41 Technical Data
- 42 Troubleshooting
- 43 Firmware Upgrade
- 43 Compatible Camera Models
- 43 Maintenance

Name of Parts

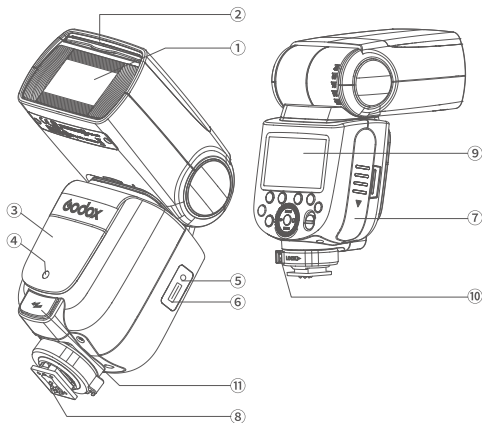

● Body

- | | |
|-------------------------|----------------------------|
| 01. Flash Head | 07. Battery Cover |
| 02. Built-in Wide Panel | 08. Hotshoe |
| 03. Wireless Sensor | 09. LCD Panel |
| 04. Focus Assist Beam | 10. Hotshoe Fixing Buckle |
| 05. Sync Cord Jack | 11. External Charging Port |
| 06. Type-C USB Port | |

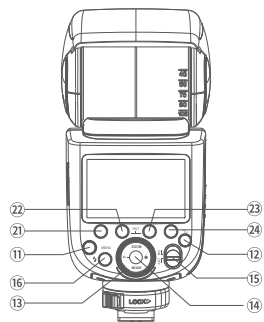
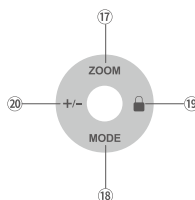

● Control Panel

- | | |
|---|----------------------------------|
| 11. <MENU> Flash Menu Button | 17. <ZOOM> Focus Length Setting |
| 12. <*Z> Wireless Selection Button | 18. <MODE> Mode Selection Button |
| 13. Select Dial | 19. <LOCK> Lock Setting |
| 14. Set Button | 20. <+/-> Power Output |
| 15. ON/OFF Power Switch | 21. Function Button 1 |
| 16. <FLASH> Test Button / Flash Ready Indicator | 22. Function Button 2 |
| | 23. Function Button 3 |
| | 24. Function Button 4 |

● LCD Panel

(1) TTL Autoflash

Zoom : zoom display (Page 40)

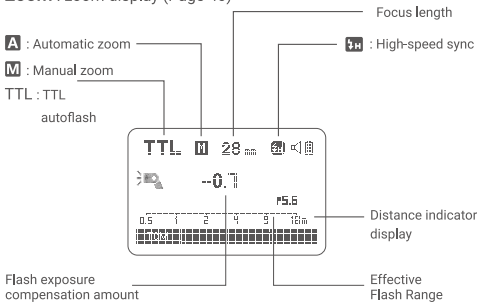

- The display will only show the settings currently applied.
- The functions displayed above function buttons 1 to 4, such as **SYNC** and <M/A/B/C>, change according to settings' status.
- The LCD panel will lighten on when buttons and dials are operated.
- When the Function Button 1 displays TCM above, short press it can switch between TTL mode and M mode.

(2) M Manual Flash

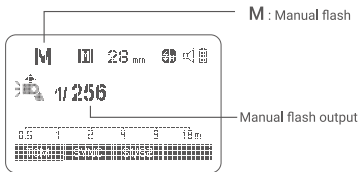

(3) Multi Flash

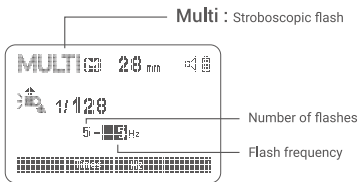

(4) Radio Transmission Shooting

● Transmitter Unit (TX)

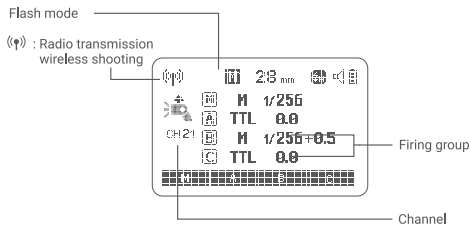

● Receiver Unit (RX)

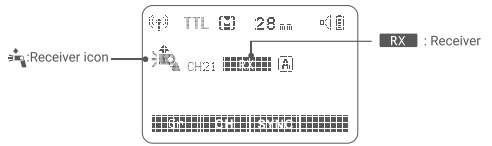

● LCD Panel in Three Modes

● Attached to the Camera

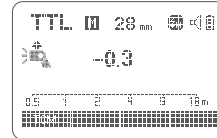

● 2.4G Radio Transmission: As a Transmitter Unit

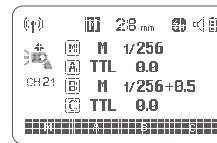

● 2.4G Radio Transmission: As a Receiver Unit

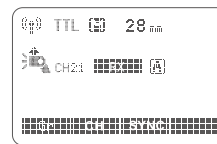

● What's in the Box of TT685IIF Kit?

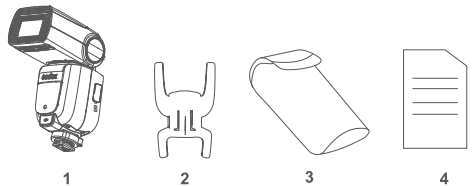

1. Flash Unit 2. Mini Stand 3. Protection Case 4. Instruction Manual

● Separately Sold Accessories

The product can be used in combination with the following accessories sold separately, so as to achieve best photography effects: XProC, X2T-C & X1C TTL wireless flash trigger, etc.



● Loading and Unloading the Battery

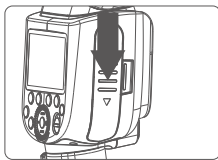

1 To unload the battery, hold down the battery and press compartment and push the battery downwardly to take it out.

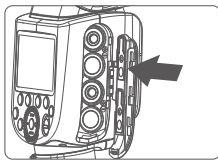

2 Put 4 batteries in with the correct polarity after opening the battery compartment, then close and push it to the top.

Tips: When collocated with the optional Godox Flash Power Box PB960, TT685IIF will have more flash times, shorter recycle time and longer duration.

TT685IIF needs battery power supply when collocating with flash power box.

Attaching to a Camera

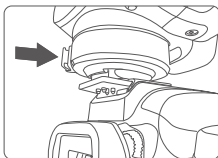

1 Attach the Camera Flash.

- Rotate the hotshoe fixing buckle to the left and insert the camera flash into the camera's hotshoe.



2 Secure the Camera Flash.

- Rotate the hotshoe fixing buckle to the right until it locks up.

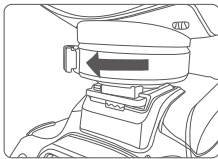

3 Detach the Camera Flash.

- Press the button and rotate the hotshoe fixing buckle to the left until it is loosened.

Power Management

Use ON/OFF Power Switch to power the flash unit on or off. Turn off if it will not be used for an extended period of time. Setting as a transmitter flash, it will turn the power off automatically after a certain period (approx. 90 seconds) of idle use. Pressing the camera shutter halfway or pressing any flash button will wake up the flash unit. Setting as a receiver flash, it will enter sleep mode after a certain period (adjustable, 60 minutes by default) of idle use. Pressing any flash button will wake it up.

C.Fn Disabling Auto Power Off function is recommended when the flash is used off camera. (C.Fn-STBY)

C.Fn Receiver Auto Power Off Timer is set to 60 minutes by default. Another option "30 minutes" is available. (C.Fn-RX STBY)

Flash Mode—TTL Autoflash

This flash has three flash modes: E-TTL, Manual (M), and Multi (Stroboscopic). In E-TTL mode, the camera and the flash will work together to calculate the correct exposure for the subject and the background. In this mode, multiple TTL functions are available: FEC, HSS, second curtain sync, control with FUJIFILM camera's menu screen.

* Press <MODE> Mode Selection Button and three flash modes will display on the LCD panel one by one with each pressing.

E-TTL Mode

Press <MODE> Mode Selection Button to enter E-TTL mode. The LCD panel will display.

- Press the camera release button halfway to focus. The aperture and effective flash range will be displayed in the viewfinder.

- When the shutter button is fully pressed, the flash will fire a pre-flash that the camera will use to calculate exposure and flash output the instant before the photo is taken.

FEC: Flash Exposure Compensation

With FEC function, this flash can adjust from -3 to +3 in 1/3rd stops. It is useful in situations where minor adjusting of the TTL system is needed based on the environment.

FEC Setting:

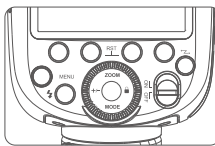

1 Press the <+/-> button. The flash exposure compensation amount will be highlighted on the LCD panel.

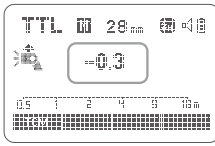

2 Set the flash exposure compensation amount.

- Turn the Select Dial to set the amount.

- "0.3" means 1/3 step,

- "0.7" means 2/3 step.

- To cancel the flash exposure compensation, set the amount to "+0".

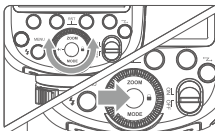

3 Press Set Button again to confirm the setting.

High-Speed Sync

High Speed Sync (FP flash) enables the flash to synchronize with all camera shutter speeds. This is convenient when you want to use aperture priority for fill-flash portraits.

- **Setting the flash to High-speed Sync mode when it is on the camera:**

Use the **F** Flash Setting > Flash Light Function Setting on the camera's shooting menu to adjust settings of the flash light. More details please refer to camera's instruction menu.

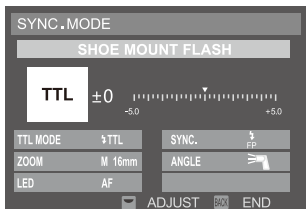

● When choosing FP on the “SYNC” setting, it means the high-speed sync function is turned on.

- With high-speed sync, the faster the shutter speed, the shorter the effective flash range.
- Multi flash mode cannot be set in high-speed sync mode.
- Over-temperature protection may be activated after 15 consecutive high-speed sync flashes.

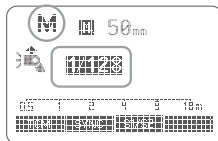

2 Press <+/-> to choose power, then turn the Select Dial to choose a desired flash output amount.

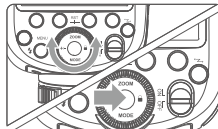

2 Press Set Button again to confirm the setting.

Optic S1 Secondary Unit Setting

In M manual flash mode, press <S1/S2> button so that this flash can function as an optic S1 secondary flash with optic sensor. With this function, the flash will fire synchronously when the main flash fires, the same effect as that by the use of radio triggers. This helps create multiple lighting effects.

Optic S2 Secondary Unit Setting

Press <S1/S2> button so that this flash can also function as an optic S2 secondary flash with optic sensor in M manual flash mode. This is useful when cameras have pre-flash function. With this function, the flash will ignore a single “preflash” from the main flash and will only fire in response to the second, actual flash from the main unit.

● S1 and S2 optic triggering is only available in M manual flash mode.

Second-Curtain Sync

With a slow shutter speed, you can create a light train following the subject. The flash fires right before the shutter closes.

● Setting second-curtain sync:

Use the Flash Setting > Flash Light Function Setting on the camera's shooting menu to adjust settings of the flash light. More details please refer to camera's instruction menu.

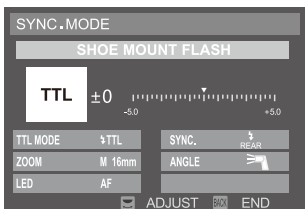

● When choosing REAR on the “SYNC” setting, it means the second-curtain sync function is turned on.

M: Manual Flash

The flash output is adjustable from 1/1 full power to 1/256th power in 1/10th stop increments. To obtain a correct flash exposure, use a hand-held flash meter to determine the required flash output.

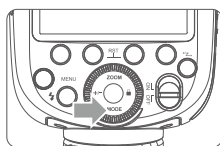

1 Press < MODE > button so that < M > is displayed.

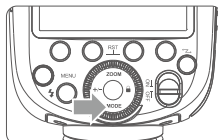

1 Press <MODE> button so that <MULTI> is displayed.

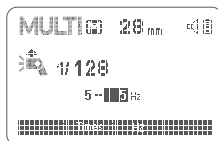

2 Set the flash frequency and flash times.

● Press the Function Button 2 <Times> to select the flash times. Turn the Select Dial to set the number.

● Press the Function Button 3 <Hz> to select the flash frequency. Turn the Select Dial to set the number.

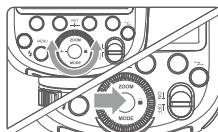

3 Turn the Select Dial to choose a desired flash output. After you finish the setting, press Set Button and all the settings will be displayed.

Wireless Flash Shooting: Radio (2.4G) Transmission

Calculating the Shutter Speed

During stroboscopic flash, the shutter remains open until the firing stops. Use the formula below to calculate the shutter speed and set it with the camera.

$$\text{Number of Flashes / Flash Frequency} = \text{Shutter Speed}$$

For example, if the number of flashes is 10 and the firing frequency is 5 Hz, the shutter speed should be at least 2 seconds.

! To avoid overheating and deteriorating the flash head, do not use stroboscopic flash more than 10 times in succession. After 10 times, allow the camera flash to rest for at least 15 minutes. If you try to use the stroboscopic flash more than 10 times in succession, the firing might stop automatically to protect the flash head. If this happens, allow at least 15 minutes' rest for the camera flash.

- Stroboscopic flash is most effective with a highly reflective subject against a dark background.
- Using a tripod and a remote control is recommended.
- A flash output of 1/1 and 1/2 cannot be set for stroboscopic flash.
- Stroboscopic flash can be used with "buLb".
- If the number of flashes is displayed as "--", the firing will continue until the shutter closes or the battery is exhausted. The number of flashes will be limited as shown by the following table.

Maximum Stroboscopic Flashes:

Flash output \ Hz	1	2	3	4	5	6-7	8-9
1/4	8	6	4	3	3	2	2
1/8	14	14	12	10	8	6	5
1/16	30	30	30	20	20	20	10
1/32	60	60	60	50	50	40	30
1/64	90	90	90	80	80	70	60
1/128	90	90	90	90	90	90	80
1/256	90	90	90	90	90	90	80

Flash output \ Hz	10	20-50	60-100
1/4	2	2	2
1/8	4	4	4
1/16	8	8	8
1/32	20	16	12
1/64	50	30	20
1/128	70	40	40
1/256	70	40	40

- You can set up five receiver groups for TTL autoflash shooting. With TTL autoflash, you can easily create various lighting effects.
- Any flash settings for the receiver units on the transmitter flash in TTL/Manual/Multi mode will be automatically sent to the receiver units. So the only thing you need to do is to set the transmitter unit for each receiver group without any operation for the receiver units at all during the shooting.
- This flash can work in TTL /M /Multi / OFF flash modes when set as a transmitter unit.
- The TT685IIF attach to the camera is called the transmitter unit, and a TT685IIS that is wirelessly controlled is called the receiver unit.
- You can also wirelessly control the TT685IIF set as the receiver unit with the transmitter X1T-C (sold separately). For details on setting the transmitter unit functions, see the transmitter's instructions.

Positioning and Operation Range (Example of wireless flash shooting)

- Autoflash Shooting with One Receiver Unit

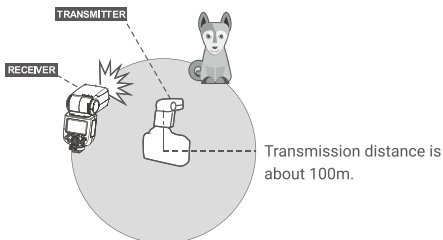

- Use the supplied mini stand to position the Receiver unit.
- Before shooting, perform a test flash and test shooting.
- The transmission distance might be shorter depending on the conditions such as positioning of Receiver units, the surrounding environment and whether conditions.

Wireless Multiple Flash Shooting

You can divide the Receiver units into two or three groups and perform TTL autoflash while changing the flash ratio (factor). In addition, you can set and shoot with a different flash mode for each firing group, for up to groups.

● Auto Shooting with Two Receiver Groups

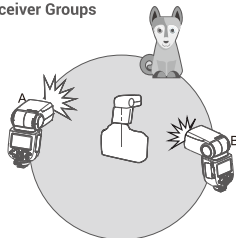

● Auto Shooting with Three Receiver Groups

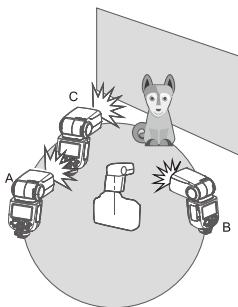

1. Wireless Settings

You can switch between normal flash and wireless flash. For normal flash shooting, be sure to set the wireless setting to OFF.

Transmitter Unit Setting

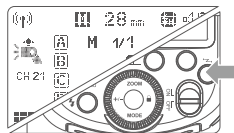

Press <←> button so that <⏪> is displayed on the LCD panel.

Receiver Unit Setting

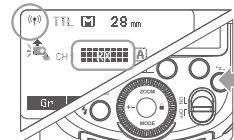

Press <←> button so that <⏪> or <⏩> is displayed on the LCD panel.

2. Setting the Communication Channel

If there are other wireless flash systems nearby, you can change the channel IDs to prevent signal interference. The channel IDs of the Transmitter unit and the Receiver unit(s) must be set to the same.

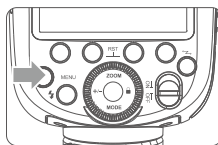

1 Press <MENU> Button to enter C.Fn CH setting.

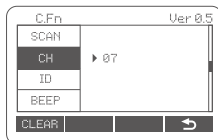

2 In C.Fn CH, turn the Select Dial to choose channel ID from 1 to 32.

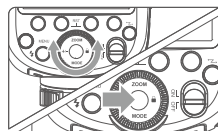

3 Press the Set Button to confirm.

3. Wireless ID Settings

Change the wireless channels and wireless ID to avoid interference for it can only be triggered after the wireless IDs and channels of the Transmitter unit and the Receiver unit are set to the same. Press the <MENU> button to enter C.Fn ID. Press the Set Button to choose OFF channel expansion shutdown, and choose any figure from 01 to 99.

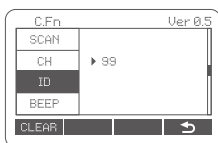

4. Scan the Spare Channel

To avoid the interference of using the same channel by others, this function can be used: enter the C.Fn settings and find the **SCAN** option. When setting to **START**, it will scan from 1% to 100%. And the 8 spare channels will be displayed after the scan is completed.

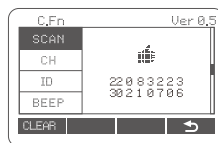

5. TTL : Fully Automatic Wireless Flash Shooting

Using Automatic Wireless Flash with a Single Receiver Unit

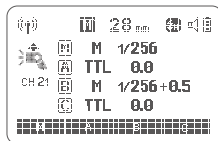

1 Transmitter Unit Setting
● Attach a TT685IIF camera flash on the camera and set it as the Transmitter unit. M/A/B/C can be set as TTL respectively.



- 2 **Receiver Unit Setting**
 - Set wireless controlled TT68SIF as the wireless Receiver Unit.
- 3 **Check the communication channel.**
 - If the Transmitter unit and Receiver unit(s) are set to a different channel, set them to the same channel.
- 4 **Position the camera and flashes.**
 - Position the camera and flashes as the picture shows.
- 5 **Check that the flash is ready.**
 - Check that the Transmitter flash ready indicator is lightened.
 - When the receiver flash ready indicator is ready, the AF-assist beam lighting area will blink at 1 second intervals.
- 6 **Check the flash operation.**
 - Press the Transmitter unit's Test Button < T >.
 - Then, the Receiver unit will fire. If not, adjust the Receiver unit's angle toward the Transmitter unit and distance from the Transmitter unit.

Using Automatic Wireless Flash with Multiple Receiver Units

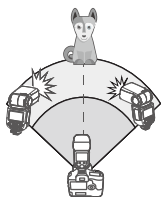

When stronger flash output or more convenient lighting operation is needed, increase the number of Receiver units and set it as a single Receiver unit. To add Receiver units, use the same steps as setting "automatic wireless flash with a single Receiver unit". Any flash group can be set (A/B/C/D/E). When the

number of Receiver units is increased and the Transmitter unit flash firing is ON, automatic control is implemented to make all groups of flashes fire the same flash output and ensure the total flash output up is to standard exposure.

- If the Receiver unit's auto power off function is workable, press the Transmitter unit's test button to power it on. Please note that test firing is unavailable during the camera's regular metering time.
 - The effective time of Receiver auto power off is changeable.
 - By making some settings, the auto AF-assist transmitter will not blink after the Receiver unit's flash ready indicator is lightened.

Using Fully Automatic Wireless Flash

The FEC and other settings that set on the Transmitter unit will also be appeared on the Receiver unit automatically. The Receiver unit does not need any operation. Use the following settings to make wireless flashes according to the same methods with normal flash shooting.

- Flash Exposure Compensation

About the Transmitter Unit

Use two or more Transmitter units. By preparing several cameras that with Transmitter units flash attached, cameras can be changed in shooting while keeping the same lighting source (Receiver unit).

6. M: Wireless Flash Shooting with Manual Flash

This describes wireless (multiple shooting) using manual flash. You can shoot with a different flash output setting for each Receiver unit (firing group). Set all parameters on the Transmitter unit.

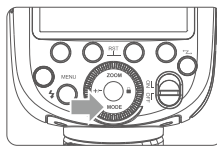

- 1 **Setting the flash mode to <M>.**

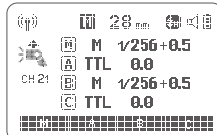

- 2 **Setting flash output.**
 - Press FunctionButton 1/2/3/4<M/A/B/C>. Turn the Select Dial to set the flash output of the groups. Press Set Button to confirm.

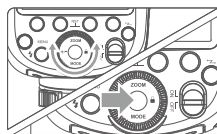

- 3 **Taking the picture.**
 - Each group fires at the set flash ratio.

Setting <M> Flash Mode

You can directly operate the Receiver unit to manually set the manual flash or stroboscopic flash.

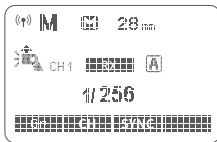

- 1 **Setting the Receiver unit.**
- 2 **Setting flash mode to <M>.**
 - Press <MODE> button so that <M> is displayed.
 - Set the manual flash output.

7. Multi: Wireless Flash Shooting with Manual Flash

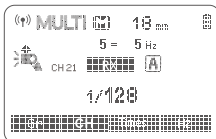

1. Setting <MULTI> stroboscopic flash.

- Press <MODE> button so that <MULTI> is displayed.
- Setting the stroboscopic flash.

⚠ The Reason & Solution of Not Triggering in Godox 2.4G Wireless

1. Disturbed by the 2.4G signal in outer environment (e.g. wireless base station, 2.4G wifi router, Bluetooth, etc.)

→ To adjust the channel CH setting on the flash trigger (add 10+ channels) and use the channel which is not disturbed. Or turn off the other 2.4G equipment in working.

2. Please make sure that whether the flash has finished its recycle or caught up with the continuous shooting speed or not (the flash ready indicator is lightened) and the flash is not under the state of over-heat protection or other abnormal situation.

→ Please downgrade the flash power output. If the flash is in TTL mode, please try to change it to M mode (a preflash is needed in TTL mode).

3. Whether the distance between the flash trigger and the flash is too close or not (< 0.5m)

→ Please turn on the "close distance wireless mode" on the flash trigger

X2 & X1 series: press the test button and hold on, then turning it on until the flash ready indicator blinks for 2 times.

XPro series: Set the C.Fn-DIST to 0-30m.

4. Whether the flash trigger and the receiver end equipment are in the low battery states or not

→ Please replace the battery (the flash trigger is recommended to use 1.5V disposable alkaline battery).

Other Applications

Sync Triggering

The Sync Cord Jack is a $\Phi 2.5$ mm plug. Insert a trigger plug here and the flash will be fired synchronously with the camera shutter.

Auto Focus Assist Beam

In poorly-lit or low-contrast shooting environments, the built-in auto focus assist beam will automatically light on to make it easier for autofocus. The beam will light up only when autofocus is difficult and get out as soon as the autofocus becomes correct.

If you want to turn off the auto focus assist beam, set the "AF" to "OFF" on the C.Fn settings.

- If you find the auto focus assist beam does not light up, this is because the camera has got a correct autofocus.

Position	Effective Range
Center	0.6~10m / 2.0~32.8 feet
Periphery	0.6~5m / 2.0~16.4 feet

Bounce Flash

By pointing the flash head toward a wall or ceiling, the flash will bounce off the surface before illuminating the subject. This can soften shadows behind the subject for a more natural-looking shot. This is called bounce flash.

To set the bounce direction, hold the flash head and turn it to a satisfying angle.

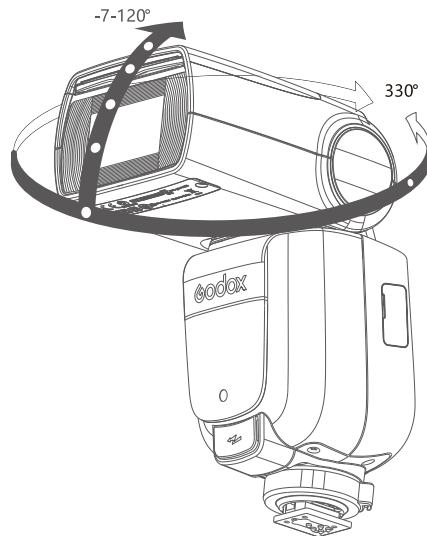

- If the wall or ceiling is too far away, the bounced flash might be too weak and result in underexposure.
- The wall or ceiling should be a plain, white color for high reflectance. If the bounce surface is not white, a color cast may appear in the picture.

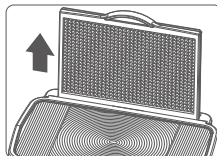

Creating a Catchlight

With the catchlight panel, you can create a catchlight in the subject's eyes to add life to the facial expression.

1. Point the flash head upward by 90°.

2. Pull out the wide panel.

The catchlight panel will come out at the same time.

3. Push the wide panel back in.

- Push in only the wide panel.
- Follow the same procedures as for bounce flash.

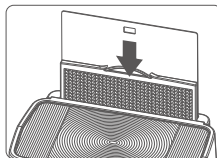

Notes:

- Point the flash head straight ahead and then upward by 90°. The catchlight will not appear if you swing the flash head left or right.

- For maximum catchlight effect, stay 1.5m/4.9ft away from the subject.

ZOOM: Setting the Flash Coverage

The flash coverage can be set automatically or manually. It can be set to match the lens focal length from 20mm to 200mm or 14mm to 133mm.

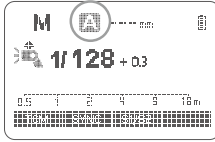

In Manual Zoom mode, press the <ZOOM> button.

- Turn the Select Dial to change the flash coverage.
- If <Z> is displayed, the flash coverage will be set automatically.

If you set the flash coverage manually, make sure it covers the lens focal length so that the picture will not have a dark periphery.

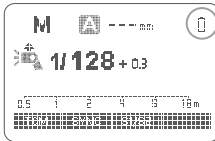

Low Battery Warning

If the battery power is low, will appear and blink on the LCD panel. Please replace the battery immediately.

C.Fn: Setting Custom Functions

The following table lists the available and unavailable custom functions of this flash.

C.Fn Custom Functions

Custom Function Signs	Function	Setting No.	Settings & Description
m/ft	Distance indicator	m	m
		ft	feet
AF	AF-assist beam RX	ON	ON
		OFF	OFF
STBY	Auto sleep setting	ON	ON
		OFF	OFF
RX STBY	Receiver auto power off timer	60min	60min
		30min	30min
SCAN	Scan the spare channel	OFF	OFF
		START	Start to find the spare channel
CH	Channel setting	01~32	Choose channels from 01-32
CH	Channel setting	01~32	Choose channels from 01-32
ID	Wireless ID	OFF	Off
		01-99	Choose any figure from 01-99

BEEP	Beeper	ON	ON
		OFF	OFF
LIGHT	Backlighting time	12sec	Off in 12 sec.
		OFF	Always off
		ON	Always lighting
LCD	LCD contrast ratio	-3~+3	7 levels
ZOOM	ZOOM display format	APS	APS system
		135	135 system
TX DIST	Firing distance	1-100m	1-100m firing
		0-30m	0-30m firing

1. Press<MENU> Button until C.Fn menu is displayed. The "Ver x.x" in the top-right corner refers to the software version.
2. Select the Custom Function No.
 - Turn the Select Dial to select the Custom Function No.
3. Change the Setting.
 - Press Set Button and the Setting No. blinks.
 - Turn the Select Dial to set the desired number. Pressing Set Button will confirm the settings.
 - After you set the Custom Function and press <MENU> button, the camera will be ready to shoot.
4. In the C.Fn states, long press the "Clear"button for 2 seconds until "OK" is displayed on the panel, which means the values in C.Fn can be reset.

Protection Function

1. Over-Temperature Protection

- To avoid overheating and deteriorating the flash head, do not fire more than 40 continuous flashes in fast succession at 1/1 full power. After 40 continuous flashes, allow a rest time of at least 10 minutes.
- If you fire more than 40 continuous flashes and then fire more flashes in short intervals, the inner over-temperature protection function may be activated. If this occurs, allow a rest time of about 10 minutes, and the flash unit will then return to normal.
- When the over-temperature protection is started, is shown on the LCD display.

Number of flashes that will activate over-temperature protection:

Number of Flashes Power Output Level	ZOOM (mm)									
	20	24	28	35	50	70	80	105	135	200
1/1	40	50	50	60	60	70	70	80	80	80
1/2	50	60	60	75	75	100	100	100	100	100
1/4	100	100	100	100	120	150	150	150	150	150
1/8	200	200	200	200	200	200	200	200	200	200
1/16	300	300	300	300	300	300	300	300	300	300
1/32	500	500	500	500	500	500	500	500	500	500
1/64	1000	1000	1000	1000	1000	1000	1000	1000	1000	1000

1/128	2000	2000	2000	2000	2000	2000	2000	2000	2000	2000	2000
1/256	2000	2000	2000	2000	2000	2000	2000	2000	2000	2000	2000

Number of flashes that will activate over-temperature protection in high-speed sync triggering mode:

Number of Flashes Power Output Level	ZOOM (mm)	20 - 200	Number of Flashes Power Output Level	ZOOM (mm)	20 - 200
1/1		30	1/16		50
1/2		30	1/32		50
1/4		34	1/64		60
1/8		40	1/128		60

2. Other Protections

The system provides real-time protection to secure the device and your safety. The following lists prompts for your reference:

Prompts on LCD Panel	Meaning
E1	A failure occurs on the recycling system so that the flash cannot fire. Please restart the flash unit. If the problem still exists, please send this product to a maintenance center.
E2	The system gets excessive heat. Please allow a rest time of 10 minutes.
E3	The voltage on two outlets of the flash tube is too high. Please send this product to a maintenance center.
E9	There are some errors occurred during the upgrading process. Please using the correct firmware upgrade method.

Technical Data

Model	TT685IIF
Compatible Cameras	FUJIFILM camera (refer to compatible camera models)
Guide No.(1/1 output, 200mm)	GN=60 (m ISO100, in meters) GN=190(ISO 100) (in feet)
Flash Coverage	20 to 200mm (135 system) or 14 to 133mm(APS system) • Auto zoom (Flash coverage set automatically to match the lens focal length and image size) Manual zoom • Swinging/tilting flash head (bounce flash): 0 to 330° horizontally and -7° to 120° vertically
Flash Duration	1/300 to 1/20000 seconds

• Exposure Control	
Exposure control system	TTL autoflash and manual flash
Flash exposure compensation (FEC)	Manual. FEC: ±3 stops in 1/3 stop increments
Sync mode	High-speed sync (up to 1/8000 seconds), first-curtain sync, and second-curtain sync
Multi flash	Provided (up to 90 times, up to 100Hz)

• Wireless Flash (2.4G Radio Transmission)	
Wireless flash function	Transmitter, Receiver, Off
Transmitter groups	M,A,B,C
Controllable Receiver groups	A, B, C, D, E (E group can be controlled by X series flash trigger)
Transmission range (approx.)	100m
Channels	32 (1~32)
ID	01~99
• Auto Focus Assist Beam	
Effective range (approx.)	Center: 0.6~10m Periphery: 0.6~5m
• Power Supply	
Power source	Ni-MH battery(recommended) or LR6 alkaline battery*4
Recycle time	0.1-2.6s (Rechargeable Ni-MH Battery,)
Full power flashes	About 290 times
Power saving	Power off automatically after approx. 90 seconds of idle operation. (60 minutes if set as Receiver)
• Sync Triggering Mode	
Working temperature	Hotshoe, 2.5mm sync line -10 C-50 C

• Dimensions	
W x H x D	195*75*59 mm
Weight without battery	408g
Weight with battery	498g
2.4G Frequency Range	2413.0MHz-2465.0MHz
Max. Transmitting Power	5dbm

Troubleshooting

If there is a problem, refer to this Troubleshooting Guide.

The Camera Flash cannot be charged.

- The battery is installed in the wrong direction.
→Install the battery in the correct direction.
- The camera flash's internal battery is exhausted.
→If < □ > appears and blinks on the LCD panel, replace the battery immediately.

The Camera Flash does not fire.

- The camera flash is not attached securely to the camera.
→Attach the camera's mounting foot securely to the camera.
- The electrical contacts of the Camera Flash and camera are dirty.
→Clean the contacts.

The power turns off by itself.

- After 90 seconds of idle operation, auto power off took effect if the flash is set as Transmitter.
→Press the shutter button halfway or press any flash button to wake up.
- After 60 minutes (or 30 minutes) of idle operation, the flash unit will enter sleep mode if it is set as Receiver.
→Press any flash button to wake up.

Auto zoom does not work.

- The camera flash is not attached securely to the camera.
→Attach the camera flash's mounting foot to the camera.

The flash exposure is underexposed or overexposed.

- You used high-speed sync.
 - With high-speed sync, the effective flash range will be shorter.
- Make sure the subject is within the effective flash range displayed.
- You used Manual Flash mode.
 - Set the flash mode to TTL or modify the flash output.

Photos have dark corners or only parts of the target subject are illuminated.

- The focal length of lens exceeds the flash coverage.
 - Check the flash coverage you set. This flash unit has the flash coverage between 20 and 200mm, (135 system) or between 14 and 133mm(APS system).

Firmware Upgrade

- The USB port is a Type-C USB socket. Type-C USB connection line is applicable.
- As the firmware upgrade needs the support of Godox G3 software, please download and install the "Godox G3 firmware upgrade software" before upgrading. Then, choose the related firmware file.
- As the product needs to do firmware upgrade, please refer to instruction manual of the newest electric version as final.

Compatible Camera Models

This flash unit can be used on the following FUJIFILM series camera models:

A类	X-PRO2、X-T20、x-T2、X-T1、GFX50S、GFX50R、X-T30、X-T4、X-T3
B类	X-Pro1、X-T10、XE1、XA3
C类	X100F、X100T

Compatible camera models & functions support

camera	Camera Flash						2.4G Wireless Control						
	Stand	REAR	HSS(FP)	M Manual Flash	Multi	Strobe	Stand	REAR	HSS(FP)	M Manual Flash	Multi	Strobe	
A	√	√	√	√	√	√	√	√	√	√	√	√	√
B	√	--	--	√	--	--	√	√	--	--	√	--	√
C	√	√	√	√	√	√	√	√	--	√	√	--	√
AF-assist Beam													
A	√												
B	--												
C	--												

1. X100T do not have second curtain sync (REAR) function.
2. The AF assist beam will light up when the shutter is at low speed (< 200).

- Rights to modify this table are retained.compatibility of other camera models,a self-test is recommended.
- Rights to modify this table are retained.

Maintenance

- Shut down the device immediately should abnormal operation be detected.
- Avoid sudden impacts and the product should be dedusted

regularly.

- It is normal for the flash tube to be warm when in use. Avoid continuous flashes if unnecessary.
- Maintenance of the flash must be performed by our authorized maintenance department which can provide original accessories.
- This product, except consumables e.g. flash tube, is supported with a one-year warranty.
- Unauthorized service will void the warranty.
- If the product had failures or was wetted, do not use it until it is repaired by professionals.
- Changes made to the specifications or designs may not be reflected in this manual.

FCC Statement

This device complies with part 15 of the FCC Rules. Operation is subject to the following two conditions: (1) This device may not cause harmful interference, and (2) this device must accept any interference received, including interference that may cause undesired operation.

Any Changes or modifications not expressly approved by the party responsible for compliance could void the user's authority to operate the equipment.

Note: This equipment has been tested and found to comply with the limits for a Class B digital device, pursuant to part 15 of the FCC Rules. These limits are designed to provide reasonable protection against harmful interference in a residential installation. This equipment generates uses and can radiate radio frequency energy and, if not installed and used in accordance with the instructions, may cause harmful interference to radio communications. However, there is no guarantee that interference will not occur in a particular installation. If this equipment does cause harmful interference to radio or television reception, which can be determined by turning the equipment off and on, the user is encouraged to try to correct the interference by one or more of the following measures:

- Reorient or relocate the receiving antenna.
- Increase the separation between the equipment and receiver.
- Connect the equipment into an outlet on a circuit different from that to which the receiver is connected.
- Consult the dealer or an experienced radio/TV technician for help.

The device has been evaluated to meet general RF exposure requirement.

The device can be used in portable exposure condition without restriction.

Warning

Operating frequency:24.12.99MHz-2464.49MHz
Maximum EIRP Power:4.94dBm

Declaration of Conformity:

GODOX Photo Equipment Co.,Ltd. hereby declares that this equipment are in compliance with the essential requirements and other relevant provisions of Directive 2014/53/EU. In accordance with Article 10(2) and Article 10(10), this product is allowed to be used in all EU member states.For more information of DoC, Please click this web link:
https://www.godox.com/DOC/Godox_TT685II_Series_DOC.pdf.
The device complies with RF specifications when the device used at 0mm from your body.

