

# AURA™ GOLF DREAMCOLOR CART

BLUETOOTH OPT7 GLOW APP & REMOTED CONTROLLED

INSTALLATION GUIDE

## COMPONENTS



LED LIGHT STRIPS WITH EXTENSION WIRE

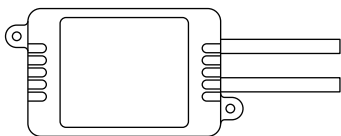

AURA CONTROL BOX (SCAN QR CODE FOR APP USER GUIDE)

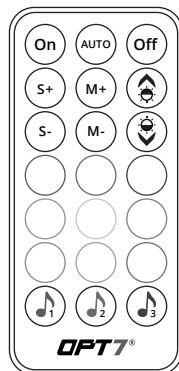

HAND HELD REMOTE

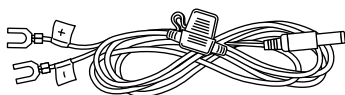

HARDWIRE POWER HARNESS

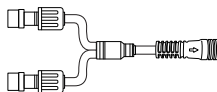

Y-SPLITTERS

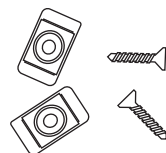

MOUNTING KIT

# INSTALLATION

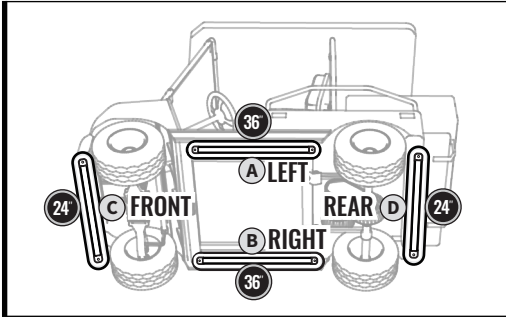

## STEP 1

Decide where to locate the control box and ensure wiring has enough length for light strips to be installed in desired location.

As shown below, connect all the LED strips to the control box.

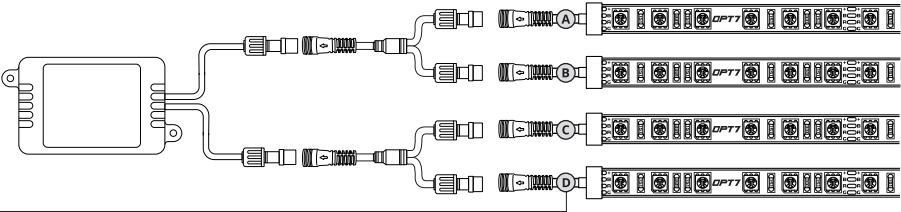

- Ⓐ 1 × 36" LED Strip + 8ft extension wire
- Ⓑ 1 × 36" LED Strip + 8ft extension wire
- Ⓒ 1 × 24" LED Strip + 8ft extension wire
- Ⓓ 1 × 24" LED Strip + 18ft extension wire

### IMPORTANT :

The extension wires are on the led strips. Lay out the strips to measure the length prior to install for a successful installation.

## ⚠ IMPORTANT ⚠

**BE SURE TO CONFIRM THE CORRECT DIRECTION OF THE ARROW!!  
TO AVOID PRODUCT DAMAGE DUE TO INCORRECT INSTALLATION.**

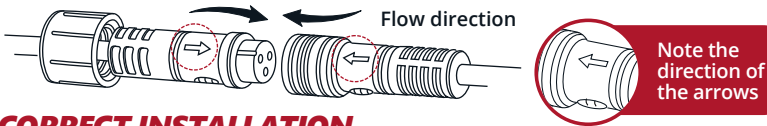

### **CORRECT INSTALLATION**

### **WARNING**

1. Please ensure that the LED bars or strips/control box/wiring all are mounted in areas where will not exceed 85°C or 185°F.
2. Connect only to a 12V battery. Using other voltages may cause overload and serious safety risks.

### **IMPORTANT**

\*Turning off the OPT7 GLOW completely helps avoid excessive battery consumption and extends the lifespan of the OPT7 light kits.

**OPT7**

# INSTALLATION

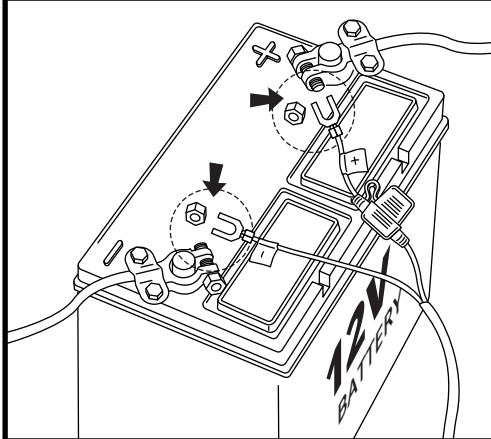

## HOW TO CONNECT POWER HARNESS TO YOUR VEHICLE

- If it is a 12V battery, you can install it according to this diagram.
- Connect the Red wire (+) of power harness to the vehicle battery's positive terminal.
- Connect the Black wire (-) of power harness to the vehicle battery's negative terminal or an unpainted area on your vehicle's frame.

AND/OR

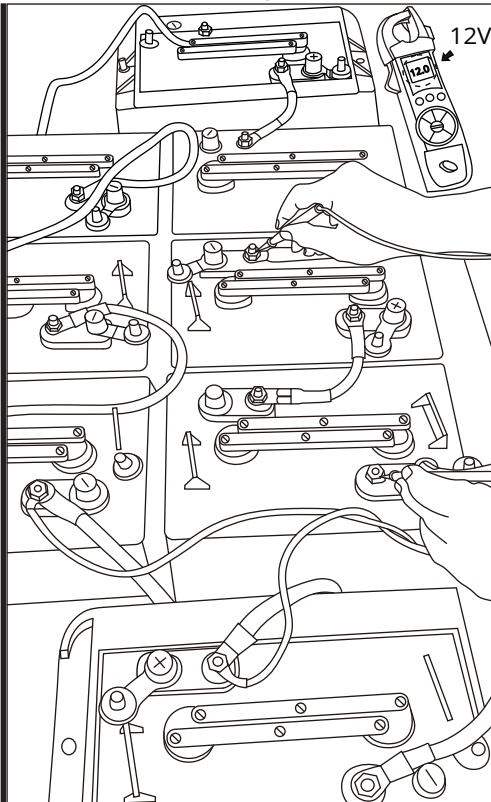

- For example, there are a total of 8 6V batteries in the picture. Use the meter to measure and confirm 12V.
- Connect the Red wire (+) of power harness to the vehicle battery's positive terminal.
- Connect the Black wire (-) of power harness to the vehicle battery's negative terminal or an unpainted area on your vehicle's frame.

# INSTALLATION

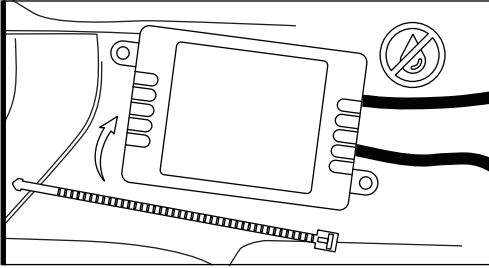

## STEP 2

Secure Control box in desired location with Velcro or zip ties.

\* CONTROL BOX NOT WATERPROOF

Ensure the control box is safely and securely hidden from exposing elements of moisture.

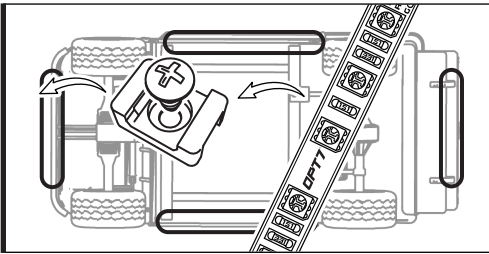

## STEP 3

Mount brackets to secure the strip first.

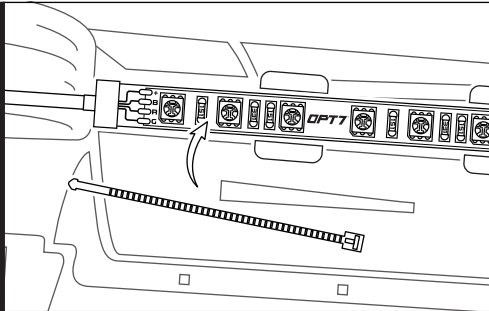

## STEP 4

Secure the light strips using the zip ties to tie all the wiring away from the moving components.

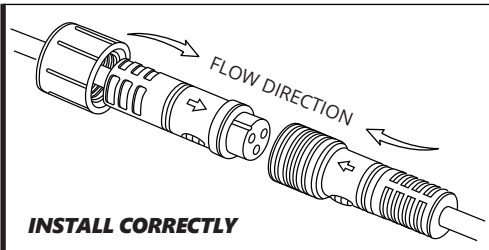

## STEP 5

Connect the round connector from the light strips to the control box and ensure that each component is properly installed and tightened.

# INSTALLATION

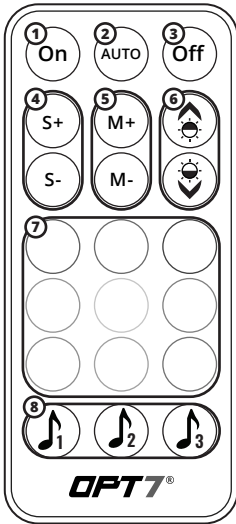

## STEP 6

Using the included 21Key E-Z Remote, select your desired color or pattern.

- 1 Power-ON
- 2 Automatic Color Change
- 3 Power-OFF
- 4 Speed +/- 10 Levels
- 5 Mode +/- 24 Mode
- 6 Dimmer 10 Levels
- 7 Color Selection 9 Colors
- 8 Sound Sync Color Selection 3 Colors

NOTE: When you use this product, keep it within 10m/33ft as much as possible.

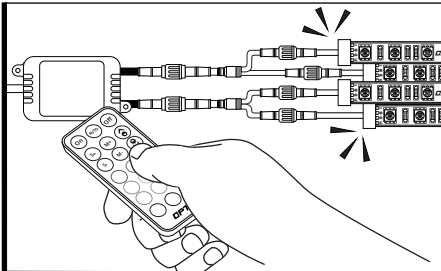

## HOW TO PAIR THE REMOTE?

### *Pair the Device:*

To pair the remote, reconnect the power, then aim the remote at the control box and hold the ON button until the LED strips flash white.

# INSTALLATION

## QR CODE TO DOWNLOAD



Download the free "OPT7 GLOW" App

- App iOS (12+) available on App Store
- Android (8+) available on Google Play

## STEP 7

Download the OPT7 GLOW to have the best experience.



Please scan to see the OPT7 GLOW user guide.

<https://wintis.ladesk.com/362302-OPT7-AURA-Glow-Application-User-Guide>

## DISCLAIMER

OPT7 Lighting is not liable for damages or personal injuries while installing this product. The Installation Guide is intended as assistance to reduce setup time. OPT7 Lighting assumes no responsibility for improper installation. If you are unfamiliar with your vehicle or inexperienced with aftermarket upgrades, please seek professional assistance.

OPT7 recommends installation for safety and guidance.

Modified installations or installation recommendations not specified by OPT7 Lighting will void product warranty.