

# INSTRUCTION MANUAL

Silonn

Rev00

---

**SLIM17**

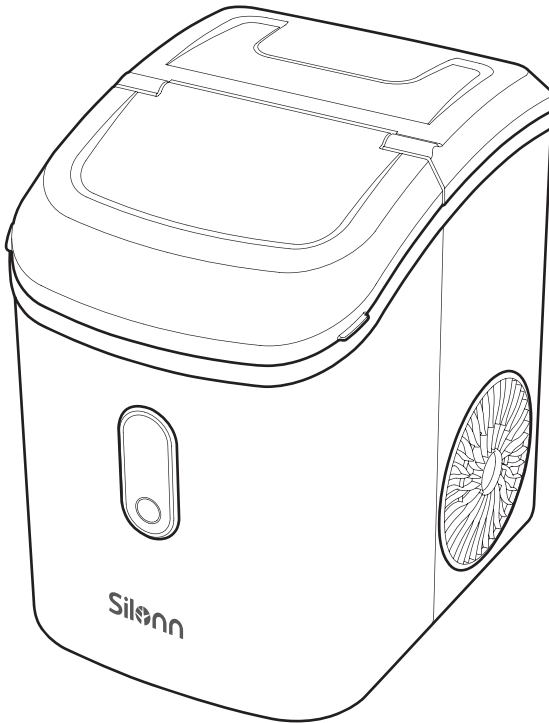

## Ice Maker

---

 877-546-8603  
(US/CA) Mon-Fri 8am - 8pm (CST)

 [support@silonn.com](mailto:support@silonn.com)

 [www.silonn.com](http://www.silonn.com)

# PAGE CONTENTS

IMPORTANT SAFETY INFORMATION .....	01
PRODUCT INTRODUCTION .....	03
CONTROL PANEL INTRODUCTION .....	04
USING YOUR ICE MAKER .....	05
CLEANING AND MAINTENANCE .....	08
PRODUCT SPECIFICATIONS .....	10
TROUBLESHOOTING .....	11
WARRANTY INFORMATION .....	13

# IMPORTANT SAFETY INFORMATION

To reduce the risk of injury or property damage, please follow these safety precautions.

## WARNING



- Voltage power from outlet must match specifications on appliance nameplate.



- This appliance **must be** grounded.



- Using an extension cord may cause overheating and increase the risk of fire.

If an extension cord **MUST** be used:

- 1) **Only use an** extension cord with grounding plug.
- 2) The marked rating of an extension cord **must be** equal to or greater than the rating of this appliance.

- **Do not** operate if any component, including the cord or plug, is damaged.
- Unplug the unit before cleaning by hand.



- Only responsible and capable adults should operate the ice maker.
- **Do not** place the power cord where it could be pulled by children or pose a tripping hazard.
- Children should not be left unattended near the ice maker during operation.



- **Do not** use water that is micro-biologically unsafe or of unknown quality.



- **Do not** remove any safety, warning, or product information labels from the unit.



- **Do not** touch the evaporator with your hands while the ice maker is operating.
- **Do not** plug in or unplug the unit with wet hands.



- The unit **must be** placed and set up according to installation instructions before use. The unit is for indoor household use only.



- **Do not** store or use flammable vapors or liquids near the unit.
- **Do not** immerse any part of the unit in water.



- **Do not** attempt to disassemble, repair, modify or replace any part of the ice maker unless permitted by the manufacturer.

## WARNING



FIRE OR EXPLOSION HAZARD Flammable Refrigerant

This unit contains an isobutane refrigerant, also known as R600a, a natural gas with high environmental compatibility. However, it is also combustible. Adhere to the warnings below to reduce the risk of injury or property damage.



1. When handling, installing, and operating the unit, care should be taken to avoid damage to the refrigerant tubing.



2. Only dispose of the unit according to Federal and Local Regulations. Contact your local authorities for the environmentally-safe disposal of the unit.



3. Keep ventilation openings around the unit's enclosure clear of obstruction.



4. **Do not** place the unit near heat sources such as an oven.



5. Ensure a minimum of three inches of clearance around the side and back walls of the unit for proper air circulation.



6. **Do not** place the unit in direct sunlight.

# PRODUCT INTRODUCTION

**Tip:** To remove the cover, place your fingers in the small opening under the left side and carefully pull up.

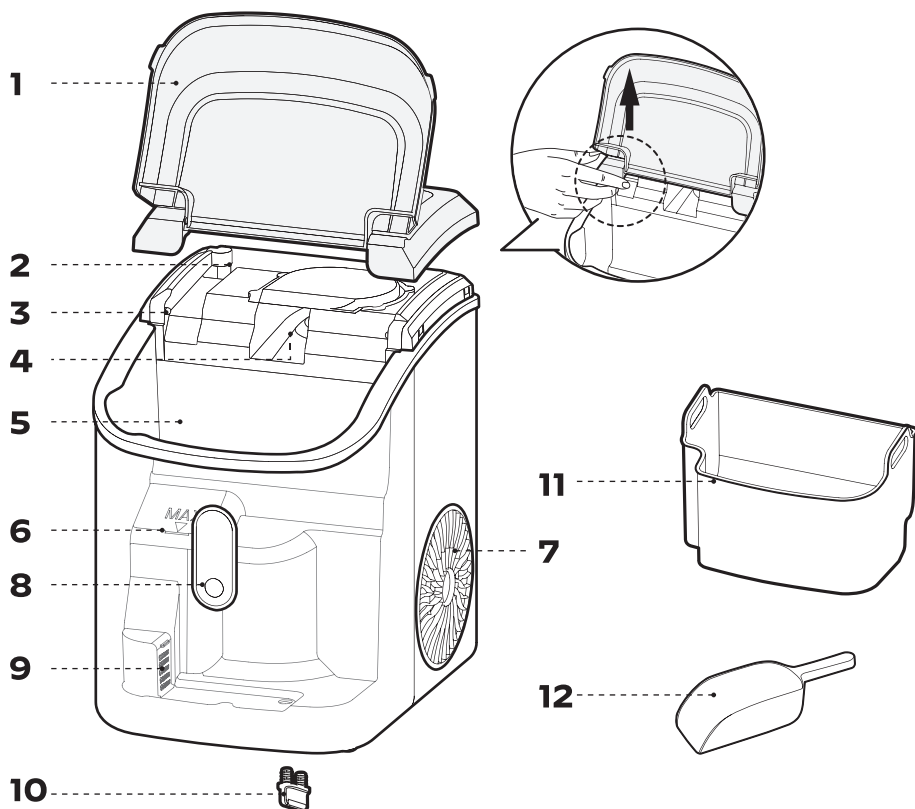

- 1. Removable Top Cover
- 2. Second Water Reservoir
- 3. Ice Full Sensor
- 4. Ice Outlet
- 5. Water Reservoir
- 6. Maximum Water Fill Line

- 7. Air Exhaust Fan
- 8. Control Panel
- 9. Water Filter
- 10. Drain Plug
- 11. Ice Basket
- 12. Ice Scoop

# CONTROL PANEL INTRODUCTION

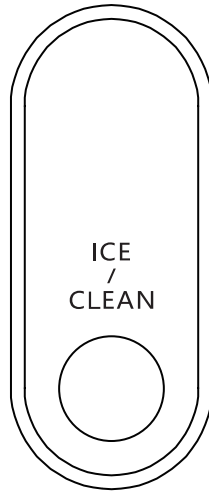

Function	Operation
MAKING ICE	When powering on or off, the ring indicator will flash white 3 times, then turn off. Press the <b>ICE/CLEAN</b> button to start making ice. The ring indicator will turn white.
SELF-CLEANING	After the ring indicator flashes white 3 times, the ice maker enters standby mode. In standby mode, press and hold the <b>ICE/CLEAN</b> button for 3 seconds and the ice maker will switch to self-cleaning mode. The ring indicator will turn blue.
ICE FULL	The ring indicator turns <b>green</b> when the ice basket is full.
ADD WATER	The ring indicator turns <b>red</b> when the water reservoir is low.

# USING YOUR ICE MAKER

## BEFORE FIRST USE

### 1.

Verify all parts and ice maker accessories were received.  
Missing parts? Contact Customer Service.



Stand upright for 24hrs.



Use in locations  
50°F ~ 90°F  
(10°C ~ 32°C).

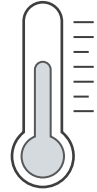

### 2.

Carefully remove the protective film and clean the ice maker thoroughly before first use.

**Note:** Make sure the drain plug is installed in place.

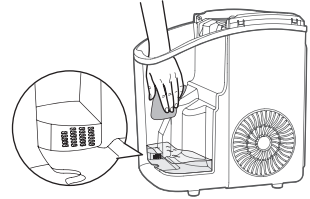

Due to temperature variations and other factors, ice quality should become stable after the first 1-3 cycles.

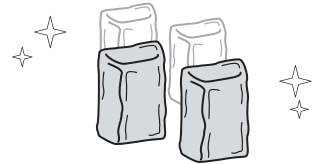

**More Cycles = Perfect Shape**

### 3. What Not To Do!

Unstable base.

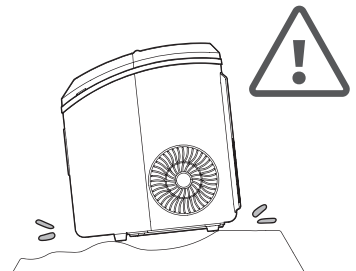

No other liquids  
(Drinking water only).

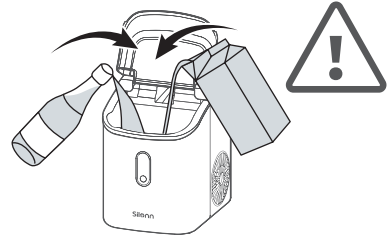

Do not use in high or low temps.

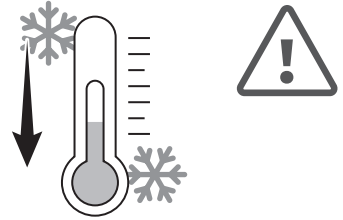

Lower than 41°F/5°C

Do not place your fingers in  
the ice outlet. The ice maker  
will detect ice is full and  
stop working. Wait 3 mins  
before further operation.

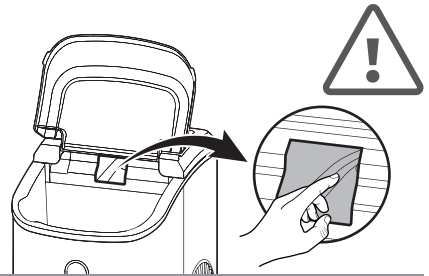

## HOW TO USE YOUR ICE MAKER

**1.**

Open the top cover and  
remove the basket.

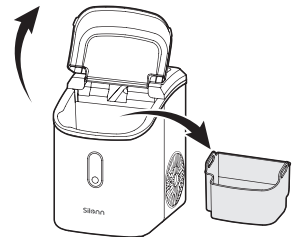

**2.**

Add water. Do not exceed the  
"MAX" water line.

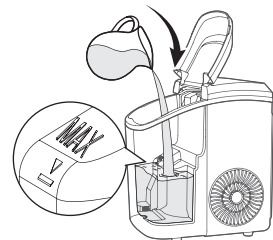

### 3.

Press the **ICE/CLEAN** button.

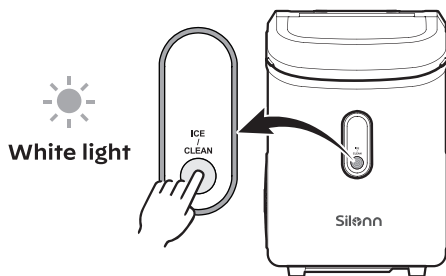

### 4.

Wait **6min-8min**. The ice-making time depends on room temp and water temp.

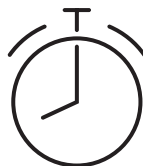

### DONE:

The ring indicator turns green when the ice basket is full.

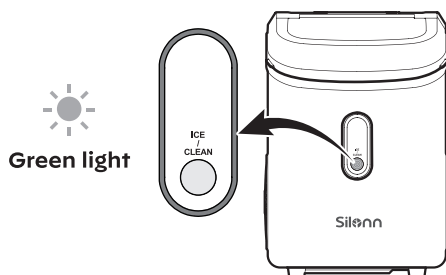

### REFILL:

When the ring indicator turns red, add water and press the **ICE/CLEAN** button to restart.

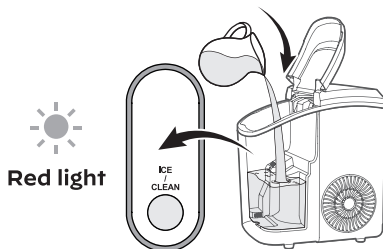

Take ice cubes out before they start to melt.

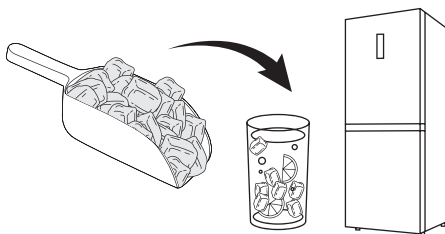

**Note:** It takes a little more time to restart the ice maker after accidental power-off.

# CLEANING AND MAINTENANCE

To keep your ice tasting fresh and the unit looking great, we recommend cleaning the unit once per week.

## SELF-CLEANING (15-MIN PROCESS)

1.

Remove the basket. Add water or water/vinegar mixture in a ratio of 5:1 to the "MAX" water line.

**Note:** In areas with hard water, professional ice maker detergent can be used to clean the ice maker. Leave the detergent in the machine for 12 hours.

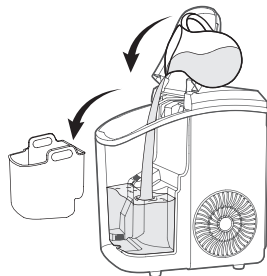

2.

**IN STANDBY MODE:**

Press and hold the **ICE/CLEAN** button for 3 sec to start self-cleaning.

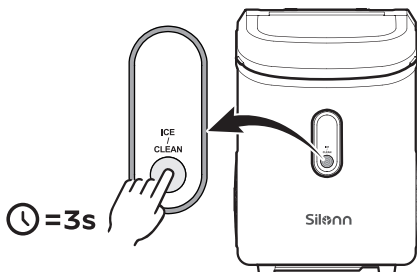

3.

Drain excess water over sink.

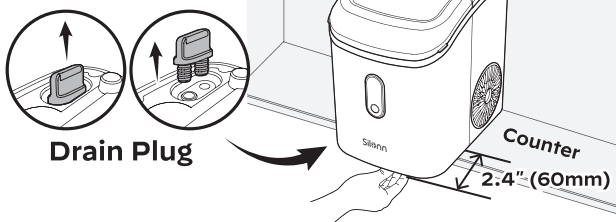

4.

Clean exterior with cloth using mild dishwashing soap.



## MANUAL CLEANING

Turn off the unit and disconnect from power before cleaning.

### 1.

Add water/vinegar mixture in a ratio of 5:1, then leave in the machine for a period of time. Clean the water filter, the ice outlet, both water reservoirs, and other small corners to prevent dirt build-up.

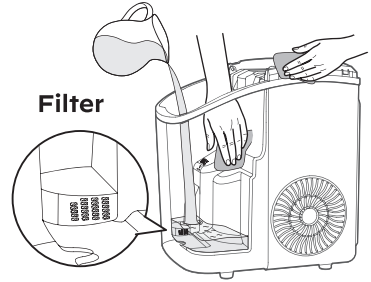

### 2.

Drain excess water over sink.

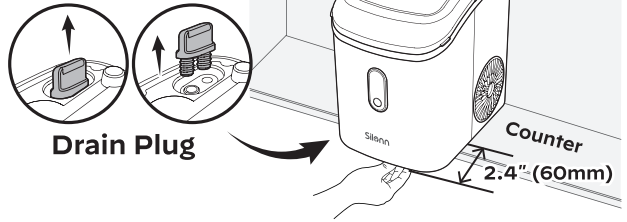

### 3.

Clean exterior with cloth using mild dishwashing soap.



## **⚠ DO's & DON'Ts while cleaning and maintaining**

- **Do not** use organic solvent, boiled water, strong acid and strong alkali etc. for cleaning.
- Considering the wide range of water quality across different regions, it is recommended to perform regular manual cleaning.
- It is recommended to **drain the water tank** at least once every three days.
- When the unit is not to be used for a long duration, **drain** the water completely & dry the interior.
- **Store** in a well-ventilated area.

## **PRODUCT SPECIFICATIONS**

<b>Voltage/Frequency</b>	120V/60Hz
<b>Ice-Making Current</b>	2.7A
<b>Water Reservoir</b>	0.29 gal (1.1L)
<b>Ice Basket Capacity</b>	1.76 lbs (0.8kg)
<b>Ice-Making Rate</b>	33 lbs (15kg) per Day
<b>Ice Shape</b>	Nugget
<b>Material</b>	ABS, PP, Stainless Steel
<b>Net Weight</b>	19.4 lbs (8.8kg)
<b>Product Size</b>	11.3 x 8.7 x 12.7 inch (287 x 220 x 322mm)

# TROUBLESHOOTING

Problem	Possible Causes	Solution
The ring indicator turns red.	Low water level or not enough water.	Stop making ice, refill water, press the <b>ICE/CLEAN</b> button, then restart and try again.
	There is too much ice.	Remove some ice.
The ring indicator turns green.	If there are no ice cubes, there may be something blocking the inner wall.	Remove the obstruction and clean the inner wall.
	The ambient temperature or the water temperature in the inner tank is too high.	Please run the ice maker in a location below 90°F and add colder water.
The ring indicator flashes in red.	Refrigerant liquid leakage.	Press the <b>ICE/CLEAN</b> button twice to restart the ice-making program. If this problem occurs again, please contact customer service.
	The cover motor is broken.	
	The pipe in the cooling system is blocked.	

<b>Problem</b>	<b>Possible Causes</b>	<b>Solution</b>
<b>Making ice too slowly.</b>	The hot air outlet has been blocked.	Maintain 5.9 inches (15cm) of distance between the hot air outlet and the wall.
	The water temperature in the inner tank is too high.	The water temperatures should be between 45°F - 90°F.
	The refrigeration system is not functioning properly.	Please contact customer service.
<b>Water leakage.</b>	The drain plug is not in place.	Reinstall the drain plug in place.
	Pipe joints in the appliance may be loose.	Please contact customer service.
	The seal has completed its service life and needs to be replaced.	
<b>Unshaped ice appears.</b>	The added water temperature is higher than the existing water, leading to machine overload.	Remove the ice cubes from the ice basket. Pause the ice maker for 15-30 minutes, then restart it.
	The hot air outlet has been blocked.	Maintain 5.9 inches (15cm) of distance between the hot air outlet and the wall.
<b>Ice maker creating harsh noise.</b>	Dirt built-up and machine overload.	Please run the ice maker in a location below 90°F and add colder water.
		Clean the ice maker regularly following the manual.
		Please contact customer service.

# WARRANTY INFORMATION

## **30-DAY LIMITED WARRANTY**

To provide customers with a quality shopping and user experience, the unit can be replaced or returned for a full refund within the 30-day period from the date of purchase.

## **30-DAY TO 1-YEAR LIMITED WARRANTY**

After the 30-day warranty has expired, a 1-year warranty from the date of purchase that covers product replacement is automatically activated. Please note that proof of purchase is required for all warranty claims.

## **30-DAY TO 1-YEAR WARRANTY LIMITATIONS**

This warranty does not cover:

- Any condition resulting from incorrect or inadequate maintenance or care.
- Damage resulting from misuse, abuse, negligence, accidents, or shipping damage.
- Dissatisfaction due to buyer's remorse.
- Normal wear and tear.
- Damages incurred after initial transportation.

# Thank You

## for Choosing Us!

All of us do appreciate your ice maker purchase. We hope that you are as happy with the ice maker as we were designing and manufacturing it for you. We strive to provide you with the best quality ice makers and services in the industry.

### Questions or Problems?

 877-546-8603      Mon–Fri, 8am–8pm (CST)

 support@silonn.com |  www.silonn.com

860-03222-00 Rev00