

Cuisinart® INSTRUCTION BOOKLET

Recipe
Booklet
Reverse Side



Cuisinart® Electric Pressure Cooker **CPC-600 Series**

For your safety and continued enjoyment of this product, always read the instruction book carefully before using.

IMPORTANT SAFEGUARDS

When using electrical appliances, basic safety precautions should always be followed including the following:

1. **Read all instructions.**
2. **Always attach plug to appliance first, before plugging into wall outlet. To disconnect, turn control to OFF, then remove plug from outlet.**
3. Do not touch hot surfaces of pressure cooker. Use handles only.
4. This appliance should not be used by or near children or individuals with certain disabilities.
5. **NEVER ATTEMPT TO OPEN LID WHILE THE UNIT IS OPERATING.**
Do not open the pressure cooker until the unit has cooled and all internal pressure has been released. If lid is difficult to rotate, this indicates that the cooker is still pressurized. Do not force it to open. Any pressure in the cooker can be hazardous. See Operating Instructions, page 5.
6. Do not place the pressure cooker in a heated oven or on any stovetop.
7. Extreme caution must be used when moving a pressure cooker containing hot liquids or foods.
8. Do not use the pressure cooker for other than intended use.
9. This appliance cooks under pressure. Improper use may result in scalding injury. Make certain unit is properly closed before operating. See Operating Instructions, page 5.
10. Do not fill unit over $\frac{3}{5}$ full. When cooking foods that expand during cooking, such as dried vegetables, legumes, beans, and grains, do not fill the unit over $\frac{1}{2}$ full. Overfilling may cause a risk of clogging the pressure limit valve and developing excess pressure.
11. To protect against electrical shock, do not immerse cord, plugs, or outer vessel in water or other liquids.
12. Unplug from outlet when not in use and before cleaning. Allow to cool before putting on or removing parts.
13. Do not operate any appliance with a damaged cord or plug or after the appliance malfunctions or has been damaged in any manner. Return appliance to the nearest authorized service facility for examination, repair, or electrical or mechanical adjustment.
14. Do not let cord hang over edge of table or counter, or touch hot surfaces.
15. Use of accessories not specifically recommended by Cuisinart may cause damage to unit.
16. Do not use outdoors.
17. Do not use under hanging cabinets; steam from pressure release may cause damage.
18. Be aware that certain foods, such as applesauce, cranberries, pearl barley, oatmeal and other cereals, split peas, noodles, macaroni, rhubarb, or spaghetti can foam, froth and sputter, and clog the pressure release devices. These foods should not be cooked in a pressure cooker unless following a Cuisinart® Electric Pressure Cooker recipe.
19. Always check the pressure release devices for clogging before use.
20. Do not use this pressure cooker for pressure frying oil.
21. Do not operate your appliance in an appliance garage or under a wall cabinet. **When storing in an appliance garage always unplug the unit from the electrical outlet.** Not doing so could create a risk of fire, especially if the appliance touches the walls of the garage or the door touches the unit as it closes.

SAVE THESE INSTRUCTIONS FOR HOUSEHOLD USE ONLY

SPECIAL CORD SET INSTRUCTIONS

A short power supply cord is provided to reduce the risks resulting from becoming entangled in or tripping over a longer cord.

Extension cords may be used if care is exercised in their use.

If an extension cord is used, the marked electrical rating of the extension cord must be at least as great as the electrical rating of the appliance, and the longer cord should be arranged so that it will not drape over the countertop or tabletop where it can be pulled on by children or tripped over.

CONTENTS

Important Safeguards.....	2
Special Cord Set Instructions	3
Parts and Features	3
Before First Use	4
Instructions for Use.....	4
Operating Instructions.....	5
Pressure Cooker Settings	6
Safety Features	6
Cleaning	7
Troubleshooting.....	8
Warranty	8

PARTS AND FEATURES

1. Pressure Limit Valve
2. Red Float Valve (Pressure Indicator)
3. Push Rod
4. Sealing Ring Assembly
5. Cooking Pot
6. Condensation Collector
7. Handle
8. Outer Body
9. Heating Plate
10. Base
11. Power Cord
12. Lid Handle
13. Lid
14. Rubber Grommet

15. Upper Ring
16. Control Panel
17. Trivet - Used for some recipes such as desserts. See Recipe Booklet.
18. BPA Free (not shown) - All materials that come in contact with food are BPA Free.

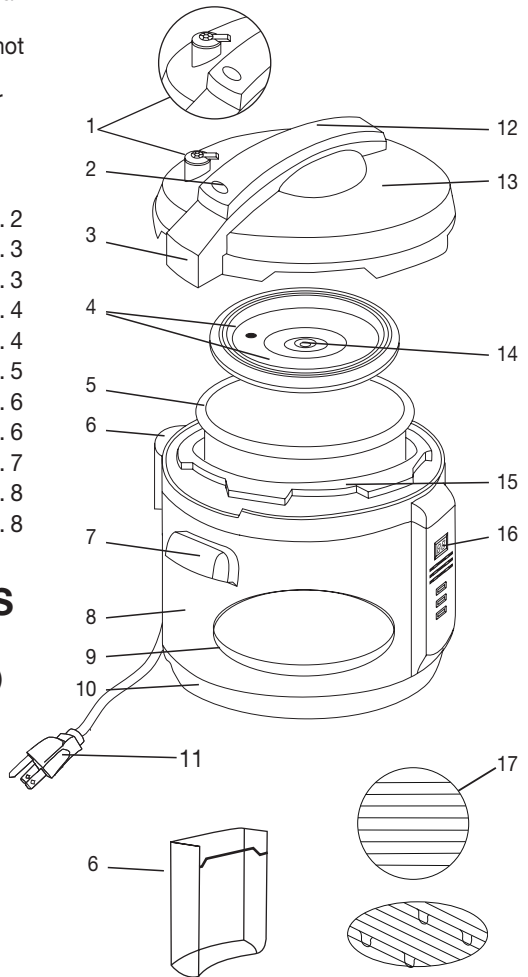

BEFORE FIRST USE

Remove any packaging materials and promotional labels from your electric pressure cooker.

Be sure all parts have been included before discarding any packaging materials. You may want to keep the box and packing materials for use at a later date.

Before using your Cuisinart® Electric Pressure Cooker for the first time, remove any dust from shipping by wiping clean with a damp cloth. Thoroughly clean the cooking pot in the dishwasher or with warm soapy water. Rinse, towel or air-dry, and place in the pressure cooker.

1. Place the pressure cooker on a clean, flat surface.
2. Place the condensation collector in rear of the unit until it clicks into place (as shown below in figure 1; and #6 on diagram, page 3).
3. Place the pressure limit valve on the lid, as shown in figure 2.
Note: The pressure limit valve does not click or lock into place. Even though it will have a loose fit, it is safely secured.

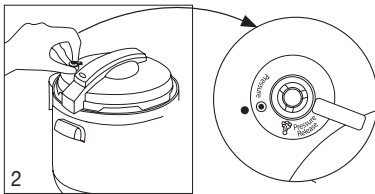
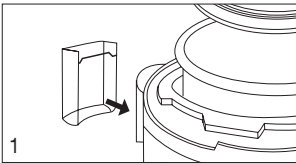

INSTRUCTIONS FOR USE

1. To remove lid, grasp handle, turn clockwise and lift.
2. Remove cooking pot from pressure cooker and add food and liquids as

the recipe directs. **NOTE:** The total volume of food and liquid must not exceed 60% of the capacity of the cooking pot (figure 3). For foods such as dried vegetables and beans, or rice and grains, the total volume must not exceed 50% capacity (figure 4).

NOTE: Overfilling may clog the pressure limit valve, which can cause excess pressure to develop. Always use at least ½ cup liquid when pressure cooking.

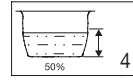
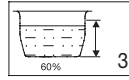

3. If sealing ring assembly has been removed from lid, check to ensure flexible ring is securely in place on the metal plate. Then, holding the knob on the metal plate, place the assembly over the center post of inner lid and press down firmly to secure (figure 5). **BE SURE KNOB FACES OUT.**
4. To lock the lid in place, remove any food residue from upper rim of cooking pot to ensure a proper seal. Place lid on pressure cooker and turn it counterclockwise into position.

NOTE: When placing lid on pressure cooker, the float valve should be facing left.

5. Position the pressure limit valve (located on lid) as directed in figure 2, ensuring it is set to the ● position. The float in handle must be fully down to properly seal the pot before cooking.

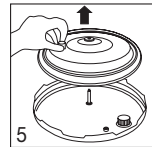

6. Plug the power cord into the pressure cooker and then into the wall outlet. The LED display will show .

OPERATING INSTRUCTIONS

With the unit on and the LED displayed, press the MENU button to select the desired cooking function. The function light will flash.

After Selecting Browning, Sauté, or Simmer

Press START, and unit will begin to heat up. When browning, sautéing or simmering is complete, press START/CANCEL to cancel and cover the cooker as directed. Wait 2 to 3 minutes to allow inner pot to cool slightly. Press MENU again and select Low or High Pressure function.

After Selecting Low or High Pressure

Press TIME to select number of minutes needed for pressure cooking. Time increases in 1-minute increments up to 40 minutes. Time increases in 5-minute increments of 40 to 99 minutes.

Once cooking time is programmed, press START/CANCEL to start the cooking process. As the unit heats up and pressure builds, the red float will rise. The amount of liquid and other ingredients in the pressure cooker determines the length of time needed for full pressure to build – generally 5 to 40 minutes, depending on the recipe. (A red blinking dot on lower right-hand corner of LED indicates the unit is on and heating up.)

Note: When full pressure is reached, red light in the lower right-hand corner of the LED will stop flashing and remain lit. Pressure cooking will begin and the timer will start to count down.

The raised red float indicates you are cooking under pressure. The lid is double-locked and cannot be opened. **YOU SHOULD NEVER ATTEMPT TO OPEN THE LID WHILE PRESSURE COOKING.**

Automatic Keep Warm Feature

When LED display reaches , the pressure cooker automatically shifts to Keep Warm temperature. The Keep Warm light will turn on and unit will beep to indicate cooking is complete.

NOTE: The Keep Warm setting should not be used for more than 12 hours. The quality or texture of the food will begin to change after 1 hour on Keep Warm. In the Keep Warm setting, a little condensation in the upper ring is normal.

To Reset or Cancel

Users can reset the function or cancel the timing setup anytime by pressing the START/CANCEL button.

To Remove Lid

When pressure cooking cycle is finished, the unit will automatically switch to the Keep Warm position. At this point you may choose to release pressure in one of three ways – Natural Pressure Release, Quick Pressure Release, or a combination of both. The choice will be dictated by the particular food being cooked and indications in the recipe. If adapting your own recipe for pressure cooking, find a similar recipe in our recipe booklet and use that as a guide.

1. Natural Pressure Release – Following pressure cooking, allow the unit to remain on Keep Warm. The pressure will begin to drop – time for pressure to drop will depend on the amount of liquid in the pressure cooker and the length of time that pressure was maintained. Natural Pressure Release will take from 12 to 30 minutes. During this time cooking continues, so it is recommended for certain cuts of meats and some desserts. When pressure is fully released, the float (pressure indicator) will drop and the lid will unlock to open.
2. Quick Pressure Release – Following pressure cooking you will hear a series of beeps indicating the process is finished. Turn off and pull the handle of the pressure limit valve forward (see figure 6). Do not touch with your hand. Use tongs or another tool.

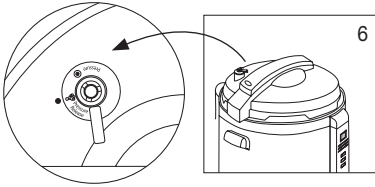

Steam will immediately begin to release through the valve. Keep face and hands away from steam as it is released, and do not release pressure under hanging cabinets, which can be damaged by steam. When pressure is fully released, the pressure indicator will drop and the lid will unlock to open. Using Quick Pressure Release stops the pressure cooking immediately. If further cooking is necessary, the unit may be returned to Pressure, or the food may be further cooked on the Simmer Setting.

3. Combination Natural Pressure Release and Quick Pressure Release – For some recipes, we have chosen to use a combination of Natural Pressure Release and Quick Pressure Release. Allow Natural Pressure Release for the time indicated in the recipe (food will continue to cook slightly) followed by Quick Pressure Release.

WARNING: USE EXTREME CAUTION WHEN RELEASING PRESSURE. USE TONGS OR SIMILAR UTENSIL TO PULL HANDLE OF PRESSURE LIMIT VALVE FORWARD.

When the red float is completely down, turn the lid clockwise and lift to remove.

PRESSURE COOKER SETTINGS

1. **Low Pressure**
2. **High Pressure**
3. **Browning** – This preset temperature allows cooking over high heat, without the lid, before pressure cooking.

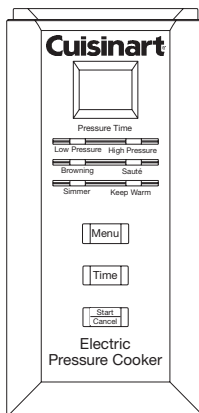

Browning foods in a small amount of fat in this way seals the outer surfaces of meats and vegetables, producing a visually appealing, flavorful exterior with a moist, tender interior. Browning reduces the time it takes full pressure to build and pressure cooking to begin.

4. **Sauté** – The preset temperature, done prior to pressure cooking with lid removed, allows you to quickly soften vegetables in a small amount of fat or liquid without browning, and to cook items such as rice (Arborio, brown, Carnaroli, white, etc.) for pilafs and risottos. Sautéing reduces the time it takes full pressure to build and pressure cooking to begin.
5. **Simmer** – This preset temperature allows you to cook liquids at a lower temperature. It is primarily used to finish cooking some items, e.g., to add ingredients to a risotto, sauce, or stew or to continue cooking process to achieve preferred texture. Simmering reduces the time it takes full pressure to build and pressure cooking to begin.
6. **Keep Warm** – Holds and keeps cooked food warm for up to 12 hours.

SAFETY FEATURES

There are seven safety devices installed in the pressure cooker to assure its reliability.

1. **Open-and-Close Lid Safety Device**
The appliance will not start pressurizing until the lid is closed and locked properly.
The lid cannot be opened if the appliance is filled with pressure.
2. **Pressure Control Device**
The correct pressure level is automatically maintained during the cooking cycle.
3. **Pressure Limit Valve**
The pressure limit valve will release air automatically when the pressure inside exceeds the preset temperature.

Note: Overfilling the pressure cooker (see Instructions for Use) may clog the pressure limit valve, which can cause excess pressure to develop.

4. Anti-Block Cover

Prevents any food material from blocking the pressure limit valve.

5. Pressure Relief Device

When the pressure cooker reaches the maximum allowable pressure and temperature, the cooking pot will move down until lid separates from the sealing ring, releasing air pressure.

6. Thermostat

The power will automatically shut off when the cooking pot temperature reaches the preset value, or the pressure cooker is heating without any food inside.

7. Thermal Fuse

The circuit will be opened when the pressure cooker reaches the maximum temperature.

7. To clean the rubber grommet in center of sealing ring assembly, carefully remove it, clean it, and replace it.

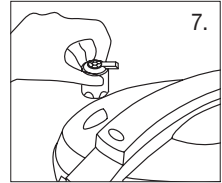

8. Replace sealing ring assembly in lid. BE SURE KNOB FACES OUT (figure 8).

9. Cooking pot is dishwasher safe. To hand-clean the pot, use a soft cloth or sponge and wipe. Be careful not to damage the inside coating. Never use harsh chemicals or scouring pads.

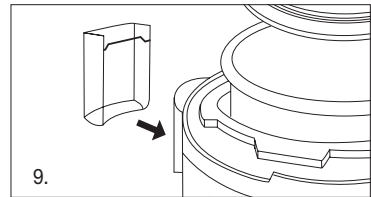
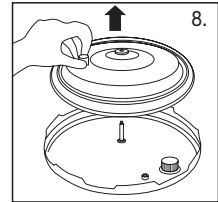

CLEANING AND MAINTENANCE

1. Unplug the power cord before cleaning.
2. Clean the outer body with a soft cloth such as a paper towel or microfiber cloth. Do not immerse the outer body in water or pour water into it.
3. Remove the sealing ring assembly from the inside of the lid by grasping the knob and pulling. Set aside.
4. Remove the pressure limit valve (figure 7) from the lid by gripping and pulling firmly upwards. Rinse with warm water, and dry.
5. Rinse the upper and underside of the lid with warm water, including the air escape on the underside and the float valve on top. Dry completely, and replace pressure limit valve.
6. To clean sealing ring assembly, carefully remove flexible sealing ring and clean with a dampened cloth or micro fiber cloth. Do not use chemical cleaners. Wash metal plate with warm water, dry thoroughly and replace sealing ring.

10. To clean the condensation collector, remove and clean it with warm soapy water, then reinstall it (figure 9).
11. Any other servicing should be performed by an authorized service representative.

TROUBLESHOOTING

Symptom	Possible Reasons	Solutions
Lid does not lock.	The sealing ring assembly is not properly installed in lid.	Re-install the sealing ring assembly as instructed in INSTRUCTIONS FOR USE, # 3.
	The float is seized by the push rod.	Push the rod with hands.
Cannot open the lid after air exhaust.	The float is still up.	Press the float down.
Air escapes from the rim of the lid.	No sealing ring was installed.	Install the sealing ring.
	Food residue on sealing ring.	Clean sealing ring.
	Sealing ring worn out.	Replace the sealing ring.
	Lid not locked properly.	Rotate lid fully.
Air escapes from the float valve.	Food stuck on the sealing ring of the float valve.	Clean the sealing ring.
	The sealing ring on the float wore out.	Replace the sealing ring.
The float will not rise.	The pressure limit valve is not placed properly.	See Before First Use, # 3, page 4.
	Not enough food and water.	Check recipe for proper quantity.
	Air escaping from the rim of the lid and the pressure limit valve.	Call our Consumer Service Center toll free at 1-800-726-0190.
Unit shuts off when START is pressed to begin Pressure Cooking.	Browning function was just used and temperature in unit is higher than Pressure Cooking temperature, so safety shutoff occurs.	After browning, let unit cool down for 2 or 3 minutes before you start Pressure Cooking.

LIMITED THREE-YEAR WARRANTY

This warranty is available to consumers only. You are a consumer if you own a Cuisinart® Electric Pressure Cooker that was purchased at retail for personal, family or household use. Except as otherwise required under applicable law, this warranty is not available to retailers or other commercial purchasers or owners.

We warrant that your Cuisinart® Electric Pressure Cooker will be free of defects in materials and workmanship under normal home use for 3 years from the date of

original purchase. We recommend that you visit our website, www.cuisinart.com for a fast, efficient way to complete your product registration. However, product registration does not eliminate the need for the consumer to maintain the original proof of purchase in order to obtain the warranty benefits. In the event that you do not have proof of purchase date, the purchase date for purposes of this warranty will be the date of manufacture.

If your Cuisinart® Electric Pressure Cooker should prove to be defective within the warranty period, we will repair it, or if we think necessary, replace it. To obtain warranty service, simply call our toll-free

number 1-800-726-0190 for additional information from our Customer Service Representatives, or send the defective product to Customer Service at Cuisinart, 7475 North Glen Harbor Blvd., Glendale, AZ 85307.

To facilitate the speed and accuracy of your return, please enclose \$10.00 for shipping and handling of the product.

Please pay by check or money order (California residents need only supply proof of purchase and should call 1-800-726-0190 for shipping instructions).

NOTE: For added protection and secure handling of any Cuisinart product that is being returned, we recommend you use a traceable, insured delivery service. Cuisinart cannot be held responsible for in-transit damage or for packages that are not delivered to us. Lost and/or damaged products are not covered under warranty.

Please be sure to include your return address, daytime phone number, description of the product defect, product model number (located on bottom of product), original date of purchase, and any other information pertinent to the product's return.

CALIFORNIA RESIDENTS ONLY:

California law provides that for In-Warranty Service, California residents have the option of returning a nonconforming product (A) to the store where it was purchased or (B) to another retail store that sells Cuisinart products of the same type.

The retail store shall then, at its discretion, either repair the product, refer the consumer to an independent repair facility, replace the product, or refund the purchase price less the amount directly attributable to the consumer's prior usage of the product. If the above two options do not result in the appropriate relief to the consumer, the consumer may then take the product to an independent repair facility if service or repair can be economically accomplished. Cuisinart and not the consumer will be responsible for the reasonable cost of such service, repair, replacement, or refund for nonconforming products under warranty. California residents may also, according to their preference, return nonconforming

products directly to Cuisinart for repair, or if necessary, replacement, by calling our Consumer Service Center toll-free at 1-800-726-0190.

Cuisinart will be responsible for the cost of the repair, replacement, and shipping and handling for such products under warranty.

BEFORE RETURNING YOUR CUISINART PRODUCT

If you are experiencing problems with your Cuisinart product, we suggest that you call our Cuisinart Service Center at 1-800-726-0190 before returning your product to be serviced. If servicing is needed, a representative can confirm whether the product is under warranty and direct you to the nearest service location.

Your Cuisinart® Electric Pressure Cooker has been manufactured to the strictest specifications and has been designed for use only in 120 volt outlets and only with authorized accessories and replacement parts. This warranty expressly excludes any defects or damages caused by attempted use of this unit with a converter, as well as use with accessories, replacement parts or repair service other than those authorized by Cuisinart. This warranty does not cover any damage caused by accident, misuse, shipment or other than ordinary household use. This warranty excludes all incidental or consequential damages. Some states do not allow the exclusion or limitation of these damages, so these exclusions may not apply to you. You may also have other rights, which vary from state to state.

Important: If the nonconforming product is to be serviced by someone other than Cuisinart's Authorized Service Center, please remind the servicer to call our Consumer Service Center at 1-800-726-0190 to ensure that the problem is properly diagnosed, the product is serviced with the correct parts, and to ensure that the product is still under warranty.

Cuisinart®

SAVOR THE GOOD LIFE®



Coffeemakers



Blenders



Juicers



Cookware



Tools and
Gadgets

Cuisinart offers an extensive assortment of top quality products to make life in the kitchen easier than ever. Try some of our other countertop appliances, cookware, tools and gadgets.

www.cuisinart.com

©2013 Cuisinart
150 Milford Road
East Windsor, NJ 08520
Printed in China

13CE136471

U IB-7077G

Cuisinart®

Recipe Booklet

Instruction
Booklet
Reverse Side



Cuisinart® Electric Pressure Cooker

CPC-600 Series

TIPS AND HINTS

- Many family favorites can be easily adapted for preparation in your Cuisinart™ Electric Pressure Cooker – soups, stews, side dishes and more.
- The amount of liquid needed is much less than for traditional cooking methods.
- Never exceed the Maximum Fill Amount of the pressure cooker.
- Make sure the lid is on firmly and tightly, and moved as far counterclockwise as it will go to allow proper locking.
- Hot foods/liquids will come to pressure more quickly than cold foods/liquids.
- When pressure cooking is completed, follow recipe instructions for releasing pressure. For Quick Pressure Release it is important to begin immediately upon completion of pressure cooking; otherwise foods will continue to cook, and may overcook.
- Do not store pressure cooker with lid on tightly. This saves on gasket wear and tear.
- More nutrients are preserved during pressure cooking than with traditional cooking methods, as less liquid is used and thus fewer nutrients are lost to evaporation.
- To adapt your own recipes, find a similar one in our cookbook and use it as a guide. In general, cooking time will be at least $\frac{1}{3}$ to $\frac{1}{2}$ of the traditional cooking time. Reduce your cooking liquid by at least half – you may need to “play” with your recipe to get it right. You may wish to add vegetables at the end of cooking to avoid overcooking. You can also use the cooking charts provided as a guide.
- If something is almost cooked, use Simmer to complete cooking.

CHARTS:

COOKING TIMES

Poultry and Meats.....	2-3
Vegetables.....	4
Rice and Grains.....	5
Dried Beans.....	6
LIST OF RECIPES.....	7

Pressure Heat-Up Times

When pressure cooking, remember that it will take approximately 5 to 40 minutes (depending on the recipe) for pressure to build and pressure cooking to begin.

Suggested Cooking Times for Poultry and Meats

Be sure to add at least 1 cup of liquid when pressure cooking meats for 45 minutes or less, and $1\frac{1}{2}$ cups if cooking for longer amounts of time. Be sure to add vegetables such as chopped onions, carrots, and celery and aromatic herbs such as garlic, parsley, thyme, etc. for added flavor. Most items are cooked on High Pressure unless otherwise indicated. For best results and flavor, most poultry and meats benefit from browning first. Cooking times will vary slightly due to individual size of pieces and starting temperatures.

POULTRY & MEATS

Food	Cooking Time	Pressure Release Method
Chicken		
Whole – up to 4 pounds	24 to 28 minutes	Quick Pressure Release
Chicken Breast, bone in, 3 pounds	9 to 10 minutes	Quick Pressure Release
Boneless Chicken Breast, 2 pounds	5 to 6 minutes	Quick Pressure Release
Thighs/Legs, bone in	9 to 12 minutes	Quick Pressure Release
Thighs/Legs, boneless	8 to 10 minutes	Quick Pressure Release
Beef		
Pot Roast, Bottom Round, 3-3½ pounds	99 minutes	Natural Pressure Release
Brisket, 2½-2 pounds	55 minutes	Natural Pressure Release
Corned Beef Brisket	24 minutes per pound	Natural Pressure Release
Short Ribs, 2-3 inches thick	50 minutes	Natural Pressure Release
Stew – 1½ to 2-inch cubes	10 minutes	Natural Pressure Release (see recipe for Beef Stew for times with vegetables)
Lamb		
Shanks, four, 12 ounces each	24 minutes	Natural Pressure Release
Shoulder cubes for stew, about 1½ inches	22 to 25 minutes	Natural Pressure Release
Pork		
Chops, Loin, bone in, ¾-1 inch thick	9-11 minutes, brown first	Quick Pressure Release
Boneless Shoulder Roast, about 3 pounds	50 to 55 minutes	Natural Pressure Release
Spareribs, cut into 2 to 3 rib pieces	22 to 28 minutes	Quick Pressure Release
Veal		
Boneless Shoulder Roast	10 minutes per pound (weight is important to avoid overcooking)	Natural Pressure Release
Cubes for stew, 1½-2 inches	9 to 10 minutes	Natural Pressure Release

Vegetables

Vegetables should be well washed and peeled if necessary. Vegetables cook very quickly – be sure to use Quick Pressure Release immediately after audible beep sounds. If vegetables require more cooking, turn pressure cooker off, and cover to steam the vegetables until preferred texture is reached. Add ½ cup water or liquid for cooking. If pressure cooking frozen vegetables, 1 to 2 minutes additional cooking time and longer steaming time may be needed. When cooking vegetables it is always best to under cook, then allow additional time to steam – to avoid overcooking. All cooking is on High Pressure unless otherwise indicated.

Food	Cooking Time	Pressure Release Method
Artichokes 4 medium/large, 8 to 10 ounces each	7 to 9 minutes	Quick Pressure Release
Beans, Green or Yellow Wax 1½ pounds, cut into 2-inch lengths	1 to 2 minutes/Low Pressure	Quick Pressure Release
Beets , medium-large	24 to 26 minutes	Quick Pressure Release
Broccoli , cut into large florets	2 to 3 minutes	Quick Pressure Release
Cauliflower , cut into large florets	2 to 3 minutes	Quick Pressure Release
Carrots , cut into 2-inch lengths – or “baby cut”	8 minutes	Quick Pressure Release
Carrots , ½-inch slices	2 to 3 minutes	Quick Pressure Release
Corn , 4 to 6 ears (use trivet/rack)	1 minute	Quick Pressure Release
Greens , collards, kale, cut into 1-inch strips	5 to 7 minutes	Quick Pressure Release
Onions , baby peeled	2 to 4 minutes	Quick Pressure Release
Parsnips , peeled, cut into 2-inch pieces	3 to 4 minutes	Quick Pressure Release
Parsnips , ½-inch slices	1 to 2 minutes	Quick Pressure Release
Potatoes		
White , medium quartered	5 to 7 minutes	Quick Pressure Release
Red , new (2-3 oz each)	5 to 8 minutes	Quick Pressure Release
Sweet, 2-inch cubes	5 to 6 minutes	Quick Pressure Release
Squash – Winter		
Acorn , halved & seeded	6 to 8 minutes	Quick Pressure Release
Butternut , peeled & sliced	3 to 4 minutes	Quick Pressure Release
Squash, Yellow Crookneck or Zucchini , cut into ½-inch slices	1 to 3 minutes	Quick Pressure Release

Rice and Grains

Rice and grains cook best in a large amount of water, with the excess water drained when cooking and pressure release are completed. In most cases, cooking is done using High Pressure, followed by a combination of Natural and Quick Pressure Release. If further cooking is needed, select Simmer and cook until tender. Rice and grains are best slightly undercooked if they are to be added to soups or casseroles. Oil or butter must be added to prevent foaming.

A general formula to follow, unless you are preparing a specific recipe or the chart below indicates otherwise, is to cook 2 cups of the rice or grain in 6½ cups liquid with 1 to 2 tablespoons butter or oil. **DO NOT COOK MORE THAN THIS AMOUNT.**

The exception is white rice, which is cooked differently from speciality rice and grains. Use specific directions for cooking white rice.

Rice/Grain	Cooking Time/Pressure/Pressure Release
Aborio	Sauté rice in butter/oil until opaque. Add liquid. High Pressure for 6 minutes, followed by Quick Pressure Release.
Black Japonica, Brown Rice, Red Rice, Wehani Rice	High Pressure for 10 minutes. Natural Pressure Release for 10 minutes, followed by Quick Pressure Release.
Wild Rice	High Pressure for 20 minutes. Natural Pressure for 10 minutes, followed by Quick Pressure Release.
Amaranth (1 cup amaranth + 2 cups liquid/water)	High Pressure for 6 minutes. Quick Pressure Release. Followed by Simmer if too much liquid.
Kamut	High Pressure for 20 minutes. Natural Pressure for 10 minutes, followed by Quick Pressure Release.
Quinoa (1½ cups quinoa + 2¼ cups liquid/water)	High Pressure for 2 minutes. Natural Pressure Release for 10 minutes, followed by Quick Pressure Release.
Wheat Berries	High Pressure for 30 minutes. Natural Pressure Release for 10 minutes, followed by Quick Pressure Release.

White Rice

Use this method for cooking long-grain or basmati rice. The texture will be more moist and slightly stickier than rice cooked on the stovetop, more like rice from a rice cooker or from an Asian restaurant. The butter or oil are optional to prevent foaming. Salt is optional to taste (you may wish to omit salt completely if using a purchased broth).

White rice is cooked for 3 minutes on High Pressure, followed by 7 minutes on Natural Pressure Release, then Quick Pressure Release if any pressure remains.

Do not fill (rice and liquid combined) past the halfway mark when cooking white rice.

Rice Amount	Liquid/Butter or Oil	Yield (when fluffed)
1 cup	1½ cups + 1 tablespoon butter or oil	3 cups
1½ cups	2¼ cups + 1 tablespoon butter or oil	4 to 4½ cups
2 cups	3 cups + 2 tablespoons butter or oil	5½ to 6 cups
3 cups	4¼ cups + 2 tablespoons butter or oil	7½ to 8 cups
4 cups	5 cups + 2 tablespoons butter or oil	11 to 12 cups

Dried Beans

- Before cooking dried beans, pick over and discard any broken or shriveled beans or bits of dirt and debris. Rinse beans and drain.
- Beans may be soaked overnight, but the pressure cooker allows you to cook beans without presoaking.
- Onions, garlic, celery, sprigs of fresh herbs or a bay leaf may be added for additional flavor. Do not salt before cooking as salt inhibits cooking.
- Cook beans in large batches (1 pound beans + 8 cups water + seasonings + onion, garlic, herbs to taste + 4 teaspoons oil) and freeze in 1-cup amounts to add to other dishes.
- Never fill pressure cooker more than one-third full when cooking beans.
- Add 2 teaspoons oil per cup of beans to prevent foaming.
- After cooking beans, clean lid, gasket, steam release valve, and float valve carefully.
- When cooking beans, use High Pressure and Natural Pressure Release.
- If beans are not completely cooked (this is partially dependent on the age of the dried beans, something you will have no control over) select Simmer and allow the beans to simmer until cooked tender. As with vegetables it is better to under cook and allow to simmer to complete cooking.

Beans (1 cup)	Cooking Time (soaked overnight)	Cooking Time (unsoaked)	Yield
Black Beans	20 to 25 minutes	28 to 32 minutes	2 cups
Cannellini	18 to 22 minutes	33 to 38 minutes	2 cups
Chickpeas (Garbanzo Beans)	35 to 40 minutes	50 to 60 minutes	2½ cups
Great Northern	25 to 30 minutes	30 to 35 minutes	2¼ cups
Lentils	N.A.	8 to 10 minutes	2 cups
Pinto	20 to 24 minutes	30 to 35 minutes	2¼ cups
Navy Beans	22 to 25 minutes	30 to 35 minutes	2 cups
Red Beans	22 to 25 minutes	30 to 35 minutes	2 cups
Soybeans	26 to 33 minutes	33 to 40 minutes	1¼ cups

RECIPES

Appetizers, Beans, Grains, Salads

Artichokes	8
Fava Bean Purée	8
Hummus	8
Baba Ghanoush	9
Savory Gorgonzola Cheesecake	9
Not the Same Old Three-Bean Salad	10
Wheat Berry & Vegetable Salad	11

Soups

Pasta e Fagioli	11
Cuban Black Bean Soup	12
Lentil Soup	13
Chicken Soup with Noodles	13
Tomato Soup	14
Mushroom Barley Soup	14
Chicken Stock	15
Brown Beef Stock	15

Side Dishes

Green Beans with Shiitake Mushrooms	16
New Potatoes with Parsley	16
Garlic & Herb Smashed Potatoes	16
Sweet Potato Purée	17
Rice Pilaf	17
Tzimmes	18
Corn Pudding	18
Curried Cauliflower & Potatoes	19
Beet Salad with Feta, Toasted Walnuts & Champagne Vinaigrette	19

Entrées

Risotto Primavera	20
Risotto with Shrimp, Sugar Snap Peas & Tarragon	21
Pesto Chicken with Potatoes & Carrots	21
Chicken with Herb Dumplings	22
Curried Chicken Salad with Apples & Almonds	23
Green Chicken Chili	23
Turkey Chili	24
Meat Sauce for Pasta	24
Mediterranean Brisket of Beef/Pot Roast	25
Classic Beef Stew	26
Boneless Veal Shoulder Roast Stuffed with Sage Mushrooms	26
Veal Shanks with Mushrooms & Sun-Dried Tomatoes	27
Veal Stifado	28
Braised Lamb Shanks with Artichokes & Olives	28
Pork Chops with Balsamic, Onions & Figs	29
Pork Barbecue	30
Sausages with Peppers & Onions	30
Corned Beef with Vegetables	30

Desserts

Lemon Cheesecake	31
Mango Coconut Bread Pudding	32
Creamy Rice Pudding	33
Ginger Steamed Pears with Vanilla Bean Mascarpone Cream	33
Simple Raspberry Sauce	34

Artichokes

Perfect artichokes, ready in just 8 minutes!

Makes 4 servings

- 4 medium artichokes (about 6 to 7 ounces each)**
- 2 lemons, cut in half**

Place 1 cup of water with the juice of one lemon in the cooking pot of the Cuisinart™ Electric Pressure Cooker.

Prepare artichokes by cutting the stem off at the base, cut 1/3 off the top, and trim off the outer layers of tough leaves. An optional step is to open up the leaves at the top and remove the choke (the inner thorny leaves and fuzz) with a melon baller or spoon.

Rub the cut parts of the artichoke with the remaining lemon halves. Place them top down in the pot. Lock lid in place. Select High Pressure and set timer for 8 minutes. When audible beep sounds, use Quick Pressure Release to release all of the steam. When float valve drops, remove lid carefully, tilting away from you to allow steam to disperse.

Serve immediately with melted butter or your favorite dipping sauce.

Nutritional information per serving (one artichoke):
Calories 89 (8% from fat) • carb. 18g • pro. 6g
• fat 1g • sat. fat 0g • chol. 0mg • sod. 105mg
• calc. 42mg • fiber 8g

Fava Bean Purée

Prepare this springtime favorite year round with dried fava beans. Serve on crostini, bruschetta, or pita crisps with a drizzle of extra virgin olive oil and a shaving of Parmesan, or serve puréed as a side dish with roast spring lamb.

Makes about 4 cups

- 1 pound dried fava beans, rinsed**
- 4 cups water**
- 1 bay leaf**
- 1 cup chopped onion**
- 1 clove garlic, peeled**
- ¼ cup extra virgin olive oil**
- 2 tablespoons fresh lemon juice**
- 1 teaspoon kosher salt**

Place fava beans in cooking pot of the Cuisinart™ Electric Pressure Cooker with water and bay leaf. Cover and lock lid in place. Select High Pressure and set timer for 18 minutes. When audible beep sounds, use Natural Pressure Release. When float valve drops, remove lid carefully, tilting away from you to allow steam to disperse. Drain beans, and discard bay leaf. When cool enough to handle, remove tough outer shells.

Place partially cooked beans back in cooking pot of the Cuisinart™ Electric Pressure Cooker with chopped onion, garlic, and 1/2 cup water. Select High Pressure and set timer for 5 minutes. When audible beep sounds, use Quick Pressure Release to release pressure. Turn off. When float valve drops, remove lid carefully, tilting away from you to allow steam to disperse.

Transfer bean mixture to a food processor fitted with metal chopping blade. Add olive oil, lemon juice, and salt. Process until completely puréed, smooth and creamy. Serve warm, or chill until ready to serve.

Nutritional information per serving (¼ cup):
Calories 82 (38% from fat) • carb. 10g • pro. 3g
• fat 4g • sat. fat 0g • chol. 0mg • sod. 86mg
• calc. 18mg • fiber 2

Hummus

Makes about 2 cups

- 1 cup garbanzo beans (chickpeas)**
- 4 cups water**
- 1 tablespoon fresh parsley leaves**
- 1 small garlic clove**
- 2 tablespoons tahini**
- 1 teaspoon kosher salt**
- 1 to 2 tablespoons lemon juice**
- 5 tablespoons water**
- ¼ cup olive oil**

Place garbanzo beans and water in the cooking pot of the Cuisinart™ Electric Pressure Cooker. Lock lid in place. Select High Pressure. Set timer for 40 minutes. When audible beep sounds use Natural Pressure Release to release all of the pressure. When float valve drops, remove lid carefully, tilting away from you to allow steam to disperse. Test garbanzos; if still firm, select Simmer and cook until they reach soft consistency. (Garbanzo beans will also continue to cook as they sit in the hot water.) Strain.

Place cooked garbanzos in the work bowl of food processor fitted with metal chopping blade. Add parsley, garlic, tahini, salt, and lemon juice in bowl and pulse to combine. Scrape work bowl and with machine running add the water and olive oil until smooth. Taste and adjust seasonings accordingly.

Serve with pita and vegetable crudité.

Nutritional information per serving (2 tablespoons):
 Calories 60 (70% from fat) • carb. 3g • pro. 1g
 • fat 5g • sat. fat 1g • chol. 0mg • sod. 85mg
 • calc. 11mg • fiber 3g

Baba Ghanoush

Instead of heating up the kitchen to roast the eggplant, cooking it in your pressure cooker keeps the kitchen cool.

Makes about 1½ cups

- 1 **tablespoon olive oil**
- 1 **large eggplant, about 1 pound, peeled and cut into 1-inch cubes**
- 4 **garlic cloves, peeled**
- ½ **cup water**
- 2 to 3 **tablespoons fresh parsley leaves**
- ½ **teaspoon kosher salt**
- 2 **tablespoons lemon juice**
- 2 **tablespoons tahini paste**
- 1 **tablespoon olive oil**

Place olive oil in the cooking pot of the Cuisinart™ Electric Pressure Cooker. Select Sauté. Stir eggplant and garlic into the pot. Cook until soft and slightly golden, about 5 minutes. Add water. Lock lid in place. Select High Pressure. Set timer for 4 minutes. When audible beep sounds use Quick Pressure Release to release pressure. When float valve drops, remove lid carefully, tilting away from you to allow steam to disperse.

Strain the eggplant and garlic and place into work bowl of food processor fitted with metal chopping blade. Add the parsley, salt, lemon juice, and tahini, and pulse to process. Scrape bowl, add olive oil, and pulse until fully combined. Taste and adjust seasoning accordingly.

Serve with pita and vegetable crudité.

Nutritional information per serving (2 tablespoons):
 Calories 49 (67% from fat) • carb. 3g • pro. 1g
 • fat 4g • sat. fat 1g • chol. 0mg • sod. 58mg
 • calc. 12mg • fiber 1g

Savory Gorgonzola Cheesecake

Serve with crackers or slices of crusty breads. May also be sliced and served on tender greens as a salad. Garnish with fresh fruit such as sliced pears, apples or figs.

Makes one 7-inch cheesecake, 16 slices

- 2 **teaspoons unsalted butter, melted**
- 3 **tablespoons walnut halves and pieces, toasted**
- 1½ **pounds cream cheese (do not use low fat), at room temperature, cut into 1-inch pieces**
- 3 **large eggs, at room temperature**
- 2 **teaspoons fresh lemon juice**
- 1 **teaspoon rubbed sage**
- ⅛ **teaspoon freshly ground white pepper**
- 1 **cup Gorgonzola dolce, crumbled**

Lightly coat a 7x3-inch springform pan with melted unsalted butter or coat with cooking spray. Place a sheet of plastic wrap (about 16x16 inches) on top of a sheet of aluminum foil the same size. Place the springform pan in the center and wrap the exterior tightly.

Place the walnuts in a food processor fitted with the metal chopping blade and pulse until chopped finely. Sprinkle the chopped nuts over the bottom and sides of the buttered pan, leaving excess nuts on the bottom.

Place the cream cheese in the food processor and process until smooth, about 1 minute. Scrape the work bowl, process 30 seconds longer. Add the eggs, lemon juice, sage and pepper. Process until smooth, 1 minute. Scrape the work bowl and process 15 seconds longer. Sprinkle the Gorgonzola over the cream cheese mixture and pulse 10 times to incorporate. Pour into prepared pan.

Place trivet/rack in the cooking pot of the Cuisinart™ Electric Pressure Cooker and add 2 cups of hot water to the pot.

Cut a piece of aluminum foil about 24 inches long. Fold in half lengthwise, then fold in half again two more times to create a strip about 24 inches in length and 2 inches wide to make a “cradle.”

Place on counter and set filled springform pan in the center. Cover cheesecake with

a piece of buttered aluminum foil – making the sides tight, but allowing room for the cheesecake to expand. Bring the ends of the cradle strip upward. Use the cradle to help lower the cheesecake into the cooking pot and place on the trivet.

Cover and lock lid in place. Select High Pressure and set timer for 16 minutes. When audible beep sounds, use Natural Pressure Release to release pressure. When float valve drops, turn off. Remove lid carefully, tilting away from you to allow steam to disperse. Remove cheesecake from the cooking pot using the foil strips to lift up. Place on a cooling rack. Remove foil and plastic wrap. Dab gently with a paper towel to remove any accumulated condensation from the top of the cheesecake. Let cool to room temperature, then cover and refrigerate. Before serving remove from springform pan and garnish if desired.

*Nutritional information per serving
(¹/₁₆ of cheesecake):*

*Calories 206 (84% from fat) • carb. 2g • pro. 7g
• fat 19g • sat. fat 12g • chol. 94mg • sod. 255mg
• calc. 85mg • fiber 0g*

Not the Same Old Three-Bean Salad

Dressed with an Asian-inspired vinaigrette, this bean salad also includes fresh corn and green beans, edamame, and the bright flavor of dried cranberries.

Makes 9 cups

- 3** **tablespoons sherry vinegar**
- 2** **tablespoons fresh lime juice**
- 1½** **tablespoons low-sodium soy sauce**
- 1½** **tablespoons honey**
- 1½** **teaspoons finely chopped fresh ginger**
- 1** **teaspoon Asian chili paste with garlic**
- ⅔** **cup vegetable oil**
- 4** **ears fresh corn, husks and silks removed**
- 8** **ounces green beans, cut into ½-inch pieces on the diagonal**
- 1½** **cups frozen edamame (soybeans)**
- 1** **cup thinly sliced celery**
- 1** **cup chopped (½x¼-inch strips)**

- ¾** **red bell pepper**
- ½** **cup dried cranberries**
- 1** **cup chopped red onion**
- 1** **cup pink, pinto, black or cannellini beans, rinsed, drained and picked over**
- 1** **kosher salt and freshly ground pepper to taste**

Place sherry vinegar, lime juice, soy sauce, honey, ginger, and chili paste in a medium bowl. Whisk to combine, and while whisking, add oil in a slow, steady stream, whisking until an emulsion is formed. (This may also be done in a blender or food processor.) You will have about 1 cup of the vinaigrette dressing. Let stand while preparing the rest of the salad and allow the flavors to blend.

Place trivet/rack in the cooking pot of the Cuisinart™ Electric Pressure Cooker and place corn on rack. Add one cup of water to the cooking pot. Select High Pressure and set for 1 minute. When audible beep sounds, use Quick Pressure Release. Remove corn and plunge into a bowl of ice water to stop cooking. Place green beans on a 16-inch square sheet of parchment paper and bring corners together. Place on trivet/rack. Select High Pressure and set time for 1 minute. When audible beep sounds, use Quick Pressure Release. Remove green beans and plunge into ice water to stop cooking. Remove trivet, rack. Add edamame to cooking pot. Stir in hot water for 30 to 40 seconds. Remove and plunge immediately into a bowl of ice water to stop cooking. Drain all vegetables. Place on layered paper towels to complete draining.

Add 2 cups water to the water in the cooking pot. Add dried beans to pot. Select High Pressure and set cooking time for 11 minutes. When the audible beep sounds, use Natural Pressure Release. Test for doneness. If not completely tender, select Simmer and simmer until tender. Drain, plunge into ice water and drain again.

Cut corn from cobs and place in a large bowl with the celery, red pepper, dried cranberries, and red onions. Add cooked drained pink beans, and ⅔ of the vinaigrette (stir with whisk if it has separated). Toss gently to combine. Cover and refrigerate if not serving immediately. Stir green beans and edamame into the salad just before serving. Season to taste with salt and pepper. Transfer to a decorative bowl to serve.

Nutritional information per serving (½ cup):

Calories 123 (34% from fat) • carb. 17g • pro. 4g
• fat 5g • sat. fat 0g • chol. 0mg • sod. 34mg
• calc. 32mg • fiber 5g

Wheat Berry & Vegetable Salad

This salad is a refreshing change as a side dish.

Makes 6 cups salad (12 servings)

- 1½ cups wheat berries
- 6¾ cups water
- 1½ tablespoons vegetable oil
- ¼ cup chopped red onion
- 1½ teaspoons Dijon-style mustard
- 1 teaspoon sugar
- 1 teaspoon kosher salt
- ½ teaspoon freshly ground black pepper
- ¼ cup white balsamic vinegar (or use a fruit flavored vinegar)
- ½ cup extra virgin olive oil
- 1½ cups cut corn (use frozen thawed)
- 1 cup shredded zucchini
- ¾ cup chopped red bell pepper
- ½ cup chopped green onion
- ⅓ cup chopped sun-dried tomatoes
- ¼ cup chopped fresh parsley

Place wheat berries, water, and vegetable oil in cooking pot of the Cuisinart™ Electric Pressure Cooker. Cover and lock lid in place. Select High Pressure and set timer for 50 minutes. When audible beep sounds, turn off. Use Quick Pressure Release to release pressure. When float valve drops, turn off. Remove lid carefully, tilting away from you to allow steam to disperse. If grains are still a little chewy, select Simmer and cook until done to taste. Drain wheat berries and transfer to a large bowl.

While cooking the wheat berries, prepare the dressing. Place the red onion, mustard, sugar, salt, pepper, and vinegar in the work bowl of a food processor or mini food processor fitted with the metal chopping blade and process until smooth. Add the oil and process until emulsified. There will be about ⅔ cup dressing.

When wheat berries are cooled, add ½ cup (or more to taste) of the dressing (cover and refrigerate remaining dressing for another

use), and toss to coat. Add the corn, zucchini, red pepper, green onion, and sun-dried tomatoes. Toss gently to combine. Add the parsley; toss to combine. If not serving immediately, cover and refrigerate. Remove from refrigerator 30 minutes before serving.

Nutritional information per serving (½ cup):
Calories 110 (46% from fat) • carb. 15g • pro. 2g
• fat 7g • sat. fat 1g • chol. 0mg • sod. 148mg
• calc. 14mg • fiber 3g

Pasta e Fagioli

Try our hearty and healthy vegetarian version of this classic Italian soup.

Makes about 12 cups

- 1 tablespoon extra virgin olive oil
- 1½ cups chopped onion
- 1 cup diced (½-inch) carrot
- ½ cup sliced celery
- 3 cloves garlic, peeled and minced
- 2 teaspoons Italian herb blend, divided
- 6 cups water

- 1 pound dry cannellini or white beans, rinsed and picked over
- 1 bay leaf
- 4 cups low-sodium vegetable or chicken broth/stock
- 2 cans (14 ounces each) diced tomatoes with juice
- 1 teaspoon kosher or sea salt
- 1½ cups tubetti, small macaroni, or small shell pasta
- chopped fresh parsley
- freshly grated, shaved or shredded Parmesan or Grana Padano® cheese

Select Sauté and add oil to the cooking pot of the Cuisinart™ Electric Pressure Cooker. Heat oil for 3 to 4 minutes. When oil is hot, add the chopped onions, carrots, celery, garlic, and 1 teaspoon of the Italian herb blend. Sauté, stirring for 4 to 5 minutes, until the onions are softened and translucent. Add the water, dried beans, and bay leaf. Cover and lock lid in place. Select High Pressure and set timer for 35 minutes. When audible beep sounds, allow pressure to release naturally, about 20 minutes.

When float valve drops, turn off. Remove lid, tilting away from you to allow steam to disperse. Stir in broth/stock, tomatoes and their juices, salt, and the remaining teaspoon of Italian herb blend. Select Brown. When liquids reach boiling point, add pasta and cook according to package directions to al dente. Turn to Keep Warm to hold soup until ready to serve. Remove and discard bay leaf before serving.

Serve in warmed bowls garnished with freshly chopped parsley and grated, shaved or shredded cheese.

Nutritional information per serving (one cup):
Calories 246 (11% from fat) • carb. 46g • pro. 11g
• fat 3g • sat. fat 0g • chol. 0mg • sod. 228mg
• calc. 111mg • fiber 12g

Cuban Black Bean Soup

Makes about 10 cups

- 1 **tablespoon extra virgin olive oil**
- 12 **ounces smoked spicy chicken, turkey, or pork sausage**
- 1½ **cups chopped onion**
- 1¼ **cups chopped red bell pepper, divided**
- 3 **garlic cloves, peeled and chopped**
- 1 **tablespoon oregano**
- 1 **teaspoon cumin**
- ½ **teaspoon coriander**
- 6 **cups water**
- 1 **pound dry black beans, picked over, rinsed and drained**
- 1 **ham hock (about 1 pound) or smoked turkey wing**
- 1 **bay leaf**
- ¼ **teaspoon cayenne**
- ⅓ **cup dry sherry**
- 1 **tablespoon red wine vinegar**
- 1 **teaspoon kosher salt**

Add oil to the cooking pot of the Cuisinart™ Electric Pressure Cooker. Select Browning and let oil heat for 3 to 4 minutes. When oil is hot, cook the sausages until browned, about 4 to 5 minutes on each side. Turn off. Remove, slice into ½-inch pieces and refrigerate until ready to use.

Select Sauté, add chopped onions, ¾ cup of the chopped red bell pepper, garlic, oregano, cumin, and coriander. Sauté,

stirring until onions are translucent and tender, about

3 to 4 minutes. Add the water, black beans, ham hock, and bay leaf. Cover and lock lid in place. Select High Pressure, and set timer for 30 minutes. When audible beep sounds, allow pressure to release naturally, about 20 minutes.

When float valve drops, turn off. Remove lid, tilting away from you to allow steam to disperse. Select Simmer. Remove ham hock and bay leaf; discard bay leaf. Use a Cuisinart™ hand blender (unplug pressure cooker first and use blender carefully to avoid scratching nonstick cooking pot) or potato masher to smash beans to desired texture. Slice reserved sausage and add to soup. When hock is cool enough to handle, remove meat from ham hock and shred, adding shredded meat to soup; discard bone and fat. Add cayenne, sherry, vinegar, and salt, simmer for 15 to 20 minutes to allow flavors to blend. Turn to Keep Warm to hold soup until ready to serve.

Serve in warmed bowls as desired with freshly chopped parsley, sour cream and diced avocado. Soup may also be served with a scoop of cooked rice.

Nutritional information per serving (one cup):
Calories 140 (20% from fat) carb. 16g • pro. 10g
• fat 3g • sat. fat 1g • chol. 22mg • sod. 447mg
• calc. 35mg • fiber 5g

Lentil Soup

Makes 8 cups

- 1 **tablespoon olive oil**
- 1 **medium onion, chopped, about 1 cup**
- 1 **medium carrot, cut into ¼-inch dice, about 1 cup**
- 2 **cloves garlic, thinly sliced**
- ½ **bay leaf**
- 1 **pound dried brown lentils**
- 5 **cups chicken broth**
- 1¼ **teaspoons kosher salt**
- ¼ **teaspoon ground black pepper**
- ½ **teaspoon lemon juice**

Place oil in the cooking pot of the Cuisinart™ Electric Pressure Cooker. Select Sauté. Allow oil to heat for a few minutes and then stir the chopped onions into the pot. Sauté for about 1 to 2 minutes, until onions start to soften. Stir in the carrots. Sauté vegetables for about 4 minutes, stirring occasionally, until soft and slightly golden. Stir in garlic and sauté for another minute or two, until garlic becomes aromatic.

Add bay leaf, lentils, and chicken broth to the cooking pot. Lock lid in place. Select High Pressure. Set timer for 8 minutes. When audible beep sounds use Natural Pressure Release to release pressure. When float valve drops, remove lid carefully, tilting away from you to allow steam to disperse.

Remove and discard bay leaf. Stir in salt, pepper, and lemon juice. Taste and adjust seasonings accordingly. Serve immediately.

Note: Vary the soup by adding chopped fresh spinach or serve with freshly grated Parmesan cheese.

Nutritional information per serving (one cup):

Calories 110 (16% from fat) • carb. 16g • pro. 7g • fat 2g • chol. 0mg • sod. 515mg • calc. 21mg • fiber 5g

Chicken Soup with Noodles

This soothing soup is chock full of chicken and veggies.

Makes about 10 cups

- 1 **teaspoon unsalted butter**
- 1 **teaspoon olive oil**
- 2 **small onions, finely chopped, about 1½ cups**
- 6 **medium carrots, sliced into ¼-inch rounds, about 3 to 4 cups**
- 3 **ribs celery, cut into ¼-inch dice, about 1 cup**
- 3 to 4 **pounds mixed chicken breasts and thighs, bone in, skin removed**
- ½ **teaspoon kosher salt**
- 1 **sprig fresh parsley**
- 1 **sprig fresh thyme**
- 5½ **cups chicken broth**
- 1 to 2 **cups medium egg noodles**
- 1 **cup frozen peas (thaw while preparing soup)**

Place the butter and oil in the cooking pot of the Cuisinart™ Electric Pressure Cooker. Select Sauté. Once butter begins to sizzle, stir the chopped onions into the cooking pot. Sauté for about 1 to 2 minutes, until onions begin to soften and become translucent. Stir in the carrots and celery. Sauté vegetables for about 5 minutes, stirring occasionally. The vegetables will pick up some color but keep stirring so they do not become too brown.

Toss skinless chicken pieces with the kosher salt. Add chicken, parsley, thyme, and chicken broth to cooking pot. Lock lid in place. Select High Pressure. Set timer for 8 minutes. When audible beep sounds wait 5 minutes and then use Quick Pressure Release to release pressure. When float valve drops, remove lid carefully, tilting away from you to allow steam to disperse.

Remove chicken pieces and reserve in a stainless bowl. Remove herbs and discard. When chicken is cool enough to handle, remove meat from bones and either chop or shred and return to pot. Select Browning. Once mixture comes to a boil, select Simmer and add noodles. Cook noodles according to package directions. Once noodles have cooked, turn off, stir in peas and serve.

Nutritional information per serving (one cup):
Calories 236 (26% from fat) • carb. 16g • pro. 26g
• fat 7g • sat. fat 2g • chol. 75mg • sod. 440mg
• calc. 53mg • fiber 3g

Tomato Soup

Perfectly satisfying meal with a grilled cheese sandwich.

Makes 6 cups

- 2½** **tablespoons unsalted butter**
- 1** **small onion (about 3 ounces),
peeled and chopped**
- 1** **carrot, peeled and chopped**
- 1** **rib celery, chopped**
- 1** **teaspoon dried basil**
- ½** **teaspoon dried marjoram**
- 2** **tablespoons unbleached
all-purpose flour**
- 2** **cans (14-15 ounces each)
diced tomatoes with juices**
- 4** **whole sun-dried tomatoes,
not oil-packed**
- ⅛** **teaspoon baking soda**
- 2½** **cups vegetable or chicken stock**
- 1** **teaspoon kosher salt**
- ½** **teaspoon freshly ground pepper**
- 1** **cup half & half (optional)**

Place the butter in the cooking pot of the Cuisinart™ Electric Pressure Cooker. Select Sauté. Once butter is hot, add onions and stir. Sauté for about 1 to 2 minutes, until onions begin to soften and become translucent. Stir in the carrots, celery, basil and marjoram. Sauté vegetables for about 3 to 4 minutes, stirring occasionally, until soft but not browned. Stir in flour and cook for an additional minute. Stir in tomatoes with their juices, sun-dried tomatoes, baking soda, and stock.

Lock lid in place. Select High Pressure. Set timer for 8 minutes. When audible beep sounds, use Natural Pressure Release to release all steam. When float valve drops, remove lid carefully, tilting away from you to allow steam to disperse.

Blend soup with either a Cuisinart™ handheld blender directly in the pot or a food processor or blender. (If blending soup with handheld blender unplug pressure cooker before blending and use care not to scratch the nonstick cooking pot.)

Add the salt and pepper and taste. Adjust seasonings accordingly.

For creamy tomato soup, stir in the optional half & half.

*Nutritional information per serving
(without half & half; one cup):*
Calories 105 (40% from fat) • carb. 13g • pro. 3g
• fat 5g • sat. fat 3g • chol. 13mg • sod. 640mg
• calc. 42mg • fiber 3g

Mushroom Barley Soup

Makes about 8 cups

- 1** **tablespoon unsalted butter**
- 1** **medium onion, chopped,
about 1 cup**
- 2** **medium carrots, peeled and cut
into ¼-inch dice**
- 3** **cloves garlic, smashed**
- 16** **ounces mushrooms, sliced**
- ½** **teaspoon kosher salt**
- ½** **teaspoon fresh thyme, chopped**
- ⅓** **cup sherry**
- ¾** **cup pearl barley**
- 1** **bay leaf**
- 5** **cups chicken broth**
- ½** **teaspoon fresh ground pepper**
- 2** **tablespoons chopped fresh
parsley (about 5 sprigs)**

Place the butter in the cooking pot of the Cuisinart™ Electric Pressure Cooker. Select Sauté. Once butter begins to sizzle, stir the chopped onions into the pot. Sauté for about 1 to 2 minutes, until onions start to soften. Stir in the carrots and sauté vegetables for about 4 minutes, stirring occasionally, until vegetables are soft and lightly golden. Stir in garlic, mushrooms, salt, and thyme. Sauté until mushrooms release most of their moisture and the garlic becomes aromatic, about 5 minutes. Add sherry to the pot and cook until liquid is evaporated.

Add barley, bay leaf and chicken broth to the pot. Lock lid into place. Select High Pressure. Set timer to 10 minutes. When audible beep sounds, use the Natural Pressure Release to release all pressure. When float valve drops, remove lid carefully, tilting away from you to allow steam to disperse.

Remove and discard bay leaf. Stir in pepper. Adjust seasoning to taste. Stir in chopped parsley. For an extra kick, stir in 2 additional tablespoons of sherry. Serve immediately.

Nutritional information per serving (one cup):
Calories 130 (13% from fat) • carb. 22g • pro. 5g
• fat 2g • sat. fat 1g • chol. 4mg • sod. 397mg
• calc. 21mg • fiber 4g

Chicken Stock

Makes about 10 cups

- 4 **pounds chicken wings and/or backs**
- 2 **medium onions, peeled and quartered**
- 2 **ribs celery, cut into 2-inch lengths**
- 2 **carrots, peeled, cut into 2-inch lengths**
- 2 **leeks, trimmed, halved lengthwise, cleaned**
- 2 **parsnips, peeled, cut into 2-inch lengths**
- 2 **bay leaves**
- 12 **black peppercorns**
- 3 **sprigs parsley**
- 3 **sprigs thyme**
- 10 **cups water**

Rinse chicken and drain. Place in the cooking pot of the Cuisinart™ Electric Pressure Cooker along with the onions, celery, carrots, leeks, parsnips, bay leaves, peppercorns, parsley, thyme. Add water.

Select High Pressure and set timer for 45 minutes. When audible beep sounds, use Natural Pressure Release to release pressure. When float valve drops, turn off. Remove lid carefully, tilting away from you to allow steam to disperse.

Strain, discarding the chicken bones, meat, skin, vegetables, and herbs. Pass stock through a fine mesh strainer to remove small bits. Cover and refrigerate. When chilled and congealed, remove chicken fat and discard or reserve for another use. Chicken stock will keep for 3 days in the refrigerator, or can be frozen for up to 6 months.

Tip: Freeze chicken stock in 1-cup containers to use as needed.

For Brown Chicken Stock: Brown stock requires the step of roasting, but adds depth of flavor to the stock. Use this method to make Brown Turkey Stock ahead for gravy. Preheat oven to 400°F. Place chicken wings in a Cuisinart® roasting pan. Roast in preheated oven for about 30 minutes, until nicely browned. Add vegetables, stir and roast for an additional 10 to 15 minutes, until vegetables are browned.

Nutritional information per serving (one cup):
Calories 15 (0% from fat) • carb. 1g • pro. 1g
• fat 0g • sat. fat 0g • chol. 0mg • sod. 80mg
• calc. 0mg • fiber 0g

Brown Beef Stock

Makes 8 cups

- 2½ **pounds beef and/or veal bones**
- 1 **pound beef chuck or other stew beef, cut into 1-inch cubes**
- 2 **large carrots, peeled, cut into 3-inch lengths**
- 2 **ribs celery, cut into 3-inch lengths**
- 2 **large onions, peeled and quartered**
- 2 **tablespoons olive or vegetable oil**
- 6 **chives**
- 6 **sprigs parsley**
- 6 **sprigs thyme**
- 3 **cloves garlic**
- 12 **peppercorns**

Preheat oven to 425°F. Arrange bones, beef cubes, and vegetables in a shallow roasting pan. Drizzle with oil and toss to coat. Roast for 25 minutes, then turn and roast for an additional 25 minutes. Tie chives, parsley and thyme into a bundle using butcher's string.

Transfer browned bones, meat, and vegetables to the cooking pot of the Cuisinart™ Electric Pressure Cooker. Add bundle of herbs, garlic cloves and peppercorns. Cover with 8 cups cold water. Select High Pressure and set timer for 60 minutes. When audible beep sounds, allow Natural Pressure Release. When float valve drops, turn off. Remove

lid carefully, tilting away from you to allow steam to disperse.

Strain solids from stock and discard solids. Cover and refrigerate. Fat will solidify and come to the top. Remove and discard fat. Keep stock refrigerated until ready to use, up to 5 days, or freeze.

Tip: Freeze in 1-cup amounts to have ready to thaw and use.

Nutritional information per serving (one cup):
Calories 17 (1% from fat) • carb. 18g • pro. 38g
• fat 2g • sat. fat 0g • chol. 0mg • sod. 20mg
• calc. 14mg • fiber 0g

Green Beans with Shiitake Mushrooms

Makes about 4 cups (4 to 6 servings)

- 1/2** **tablespoon extra virgin olive oil**
- 4** **ounces shiitake mushrooms, tough stems removed and discarded, mushrooms thinly sliced**
- 1 1/2** **pounds green beans, stem ends removed, cut into 1 1/2 to 2-inch lengths**
- 1/4** **cup chopped shallot**
- 1/2** **teaspoon kosher salt**
- 1/2** **cup water**

Select Browning and add oil to cooking pot of the Cuisinart™ Electric Pressure Cooker. When hot, add mushrooms and cook for 3 to 4 minutes, until lightly browned. Turn off. Add green beans, chopped shallots, salt, and water. Cover and lock lid in place. Select High Pressure and set timer for 1 to 2 minutes, depending on personal preference for firmness/doneness of green beans. When audible beep sounds, turn off. Use Quick Pressure Release to release pressure. When float valve drops, remove lid carefully, tilting away from you to allow steam to disperse. Use a slotted spoon to transfer to warmed serving dish. Serve immediately.

Nutritional information per serving
(based on 6 servings):
Calories 51 (20% from fat) • carb. 11g • pro. 2g
• fat 1g • sat. fat 0g • chol. 0mg • sod. 115mg
• calc. 53mg • fiber 5g

New Potatoes with Parsley

Makes about 4 to 6 servings

- 3** **tablespoons unsalted butter**
- 2** **pounds medium red potatoes (about 2 ounces each), halved lengthwise**
- 1** **garlic clove**
- 3/4** **teaspoon kosher salt**
- 1/2** **cup chicken broth**
- 2** **tablespoons chopped parsley (about 5 sprigs)**

Place 1 tablespoon of butter into the cooking pot of the Cuisinart™ Electric Pressure Cooker. Select Sauté. Once butter begins to melt, stir in the potatoes, garlic, and salt. Sauté so that the butter coats all potatoes and the garlic becomes aromatic, about 4 to 5 minutes. Add the chicken broth. Lock lid in place. Select High Pressure. Set timer for 5 minutes. When audible beep sounds use Quick Release to release pressure. When float valve drops, remove lid carefully, tilting away from you to allow steam to disperse.

Strain potatoes and toss with remaining 2 tablespoons of butter and chopped parsley. Serve immediately.

Nutritional information per serving
(based on 6 servings):
Calories 175 (30% from fat) • carb. 28g • pro. 4g
• fat 6g • sat. fat 4g • chol. 16mg • sod. 226mg
• calc. 21mg • fiber 3g

Garlic & Herb Smashed Potatoes

Old-fashioned comfort food at its best. For basic mashed potatoes, omit the garlic and herbs.

Makes about 6 cups (12 servings)

- 3** **pounds Yukon Gold or russet potatoes, peeled, cut into 1/2-inch slices**
- 4** **cups water**
- 10-12** **cloves garlic, peeled**
- 2** **teaspoons kosher salt, divided**
- 1** **teaspoon white vinegar**

- ¾ **cup reduced fat milk**
- ¼ **cup half & half**
- 3 tablespoons unsalted butter, cut into ½-inch pieces**
- ¼ **cup chopped fresh chives**
- ¼ **cup chopped fresh parsley**
- ¼ **teaspoon freshly ground white or black pepper**

Place the potatoes, water, garlic, 1 teaspoon of the kosher salt, and vinegar in the cooking pot of the Cuisinart™ Electric Pressure Cooker. Cover and select High Pressure. Set timer for 7 minutes. When cooking is completed, use Quick Pressure Release. Turn off. While potatoes are cooking, combine milk with half & half in a saucepan and heat to a simmer (gentle bubbles at edges) (may also be done in a microwave-safe container in the microwave).

Remove cooking pot and drain water from potatoes. Return cooking pot to Pressure Cooker and select Simmer. Let simmer for 2 to 3 minutes to dry potatoes slightly. Sprinkle with remaining salt. Add heated milk mixture to the cooking pot, and using a potato masher suitable for nonstick cookware, mash the potatoes to break up. Add the butter, chives, parsley, and pepper to the potatoes, and mash until they reach the desired texture. Select Keep Warm and cover loosely to hold the potatoes until ready to serve.

Nutritional information per serving:
Calories 149 (28% from fat) • carb. 24g • pro. 3g
• fat 5g • sat. fat 3g • chol. 14mg • sod. 185mg
• calc. 42mg • fiber 2g

Sweet Potato Purée

A nice, subtle side dish – makes a great substitute for the regular white potato.

Makes about 4½ cups,
 about 8 to 10 servings

- 3 pounds sweet potatoes, peeled and cut into 2-inch cubes**
- 1 cup water**
- 2 tablespoons unsalted butter, room temperature**
- 1½ teaspoons kosher salt**
- 2 teaspoons packed brown sugar**
- 2 teaspoons lemon juice**

- pinch ground cinnamon**
- pinch ground nutmeg**

Place sweet potatoes and water into cooking pot of the Cuisinart™ Electric Pressure Cooker. Lock lid in place. Select High Pressure. Set timer for 6 minutes. When audible beep sounds use Quick Pressure Release to release steam. When float valve drops, remove lid carefully, tilting away from you to allow steam to disperse.

Strain sweet potatoes and place in large mixing bowl. Mash with potato masher or hand mixer. Once thoroughly mashed, add remaining ingredients. Taste and adjust seasoning accordingly. Serve immediately.

Nutritional information per serving
(based on 10 servings):
Calories 186 (12% from fat) • carb. 39g • pro. 2g
• fat 3g • sat. fat 1g • chol. 6mg • sod. 214mg
• calc. 26mg • fiber 6g

Rice Pilaf

Makes 6 cups

- 1½ tablespoons unsalted butter**
- 1 medium onion, finely chopped (about 1 cup)**
- 1 medium carrot, finely chopped**
- 1 celery stalk, finely chopped**
- 2 cups long grain white rice**
- ¼ teaspoon kosher salt**
- 3 cups chicken broth**
- sage leaf (optional)**

Place the butter in the cooking pot of the Cuisinart™ Electric Pressure Cooker. Select Sauté and let butter heat for 2 to 3 minutes. When hot, add the chopped onions, carrots, and celery. Cook, stirring occasionally and then, until onions are translucent and vegetables become aromatic, about 2 to 3 minutes. Stir in rice and cook, stirring frequently, until rice becomes opaque, about 1 to 2 minutes. Add salt, broth, and sage leaf. Cover and lock lid in place. Select High Pressure and set timer for 3 minutes. When audible beep sounds wait 3 minutes and then use Quick Pressure Release to release pressure. When float valve drops, remove lid carefully, tilting away from you to allow steam to disperse.

Fluff rice and serve immediately.

Nutritional information per serving (1/2 cup):
Calories 137 (12% from fat) • carb. 26g • pro. 3g
• fat 2g • sat. fat 1g • chol. 4mg • sod. 147mg
• calc. 17mg • fiber 1g

Tzimmes

Makes 12 servings

- 1½ pounds sweet potatoes, peeled, each potato cut into 6 large pieces
- 1 pound baby carrots
- 1 cup dried cranberries
- 1 cup dried plums
- 1 cup dried apricots
- 1 cup golden raisins
- 2 tablespoons brown sugar, lightly packed
- 1 teaspoon kosher salt
- ½ teaspoon cinnamon
- 2 tablespoons unsalted butter, (or margarine for a more traditional dish)
- ½ cup orange juice, room temperature
- ½ cup apple juice, room temperature

Combine sweet potatoes, carrots, cranberries, plums, apricots, and raisins in a large mixing bowl. Sprinkle with brown sugar, salt and cinnamon, mix thoroughly but gently.

Place butter in the cooking pot of the Cuisinart™ Electric Pressure Cooker and select Sauté. When butter is melted add sweet potato mixture. Toss to coat ingredients with butter. Stir in juices. Cover and lock lid in place. Select High Pressure and set timer for 5 minutes. When audible beep sounds use Quick Pressure Release to release pressure. When float valve drops, remove lid carefully, tilting away from you to allow steam to disperse.

Stir mixture on keep warm and allow to sit for 15 minutes before serving.

Nutritional information per serving:
Calories 234 (8% from fat) • carb. 55g • pro. 3g
• fat 2g • sat. fat 1g • chol. 5mg • sod. 148mg
• calc. 40mg • fiber 6g

Corn Pudding

Makes 8 servings

- 2 teaspoons unsalted butter, plus extra for coating soufflé dish, melted
- 1 cup chopped onion
- 1 pound cut corn, fresh or frozen, thawed and patted dry (about 8 ears, or 4 cups), divided
- 4 large eggs
- 2 cups evaporated fat free milk, not reconstituted
- ¼ cup yellow cornmeal
- 1 teaspoon salt
- ½ teaspoon freshly ground pepper to taste
- 2-4 drops hot sauce
- 2 cups water

Coat a 2-quart ceramic soufflé dish (8-inch diameter) with the melted butter and reserve. Cut a piece of aluminum foil 16 inches square and lightly butter an 8-inch round in its center. Cut a piece of aluminum foil about 24 inches long. Fold in half lengthwise, then fold in half again two more times to create a strip about 24 inches in length and 2 inches wide to make a “cradle” and reserve.

Melt butter in a 10-inch skillet over medium high heat. Add onion. Cook, stirring about 5 minutes (until translucent). Reserve.

Place 2 cups of corn in work bowl of a Cuisinart® Food Processor. Pulse four or five times, to chop corn roughly. Add eggs, evaporated milk and onion; pulse until mixed. Place the remaining 2 cups corn in a 1½-quart mixing bowl, sprinkle with cornmeal. Add chopped corn mixture. Stir until just mixed. Season with salt, pepper and hot sauce to taste. Transfer to prepared soufflé dish.

Cover with prepared sheet of foil, buttered side down, so that the foil allows for the top of the bread pudding to expand, but fits tightly around the sides of the soufflé dish. Set the dish in the center of the long strip of folded foil and bring up the sides to meet – twist together to form a handle.

Place trivet/rack in the cooking pot of the Cuisinart™ Electric Pressure Cooker

and add 2 cups of cold water. Using the foil cradle to help lift the dish and carefully lower the dish into the pot and place on the trivet/rack.

Cover and lock lid in place. Select High Pressure and set timer for 30 minutes.

When audible beep sounds, use Natural Pressure Release to release pressure. When float valve drops, turn off. Remove lid carefully, tilting away from you to allow steam to disperse. Remove pudding from the cooking pot using the foil strips to lift up. Place on a cooling rack. Remove foil. Let stand 10 minutes before serving.

Nutritional information per serving:

*Calories 174 (23% from fat) • carb. 24g • pro. 10g
• fat 5g • sat. fat 2g • chol. 109mg • sod. 410mg
• calc. 200mg • fiber 2g*

Curried Cauliflower & Potatoes

Makes 4 to 6 servings

- 1 **tablespoon olive oil**
- 2 **medium onions, sliced**
- ¾ **teaspoon kosher salt**
- ¾ **teaspoon curry powder**
- ¼ **teaspoon turmeric**
- 1½ **cups chicken broth, divided**
- 1 **head cauliflower, cut into thirds**
- 2 **medium Yukon Gold potatoes, sliced into ¼-inch rounds**

Place the olive oil in the cooking pot of the Cuisinart™ Electric Pressure Cooker. Select Sauté and let oil heat for 2 to 3 minutes. Add the sliced onions and cook, stirring occasionally for about 2 minutes. Stir in the salt, curry, and turmeric and continue cooking until onions become soft and aromatic.

Add ½ cup chicken broth and allow mixture to come to a simmer. Add the cauliflower and toss in the liquid. Cover and lock lid in place. Select High Pressure and set timer for 1 minute. When audible beep sounds use Quick Pressure Release to release pressure. When float valve drops, remove lid carefully, tilting away from you to allow steam to disperse. Remove cauliflower and reserve.

Select Sauté and toss the potato slices in with the onions for about 1 minute. Stir in

remaining 1 cup of broth. Cover and lock lid in place. Select High Pressure and set timer for 1 minute. When audible beep sounds use Quick Pressure Release to release pressure. When float valve drops, remove lid carefully, tilting away from you to allow steam to disperse.

Gently toss cauliflower in with potatoes and onions. Serve immediately.

Nutritional information per serving

(based on 6 servings):

*Calories 109 (21% from fat) • carb. 19g • pro. 4g
• fat 3g • sat. fat 0g • chol. 0mg • sod. 340mg
• calc. 37mg • fiber 4g*

Beet Salad with Feta, Toasted Walnuts & Champagne Vinaigrette

Makes about 8 cups, 8 to 12 servings

- 3 **pounds golden or red beets, scrubbed clean, ends trimmed**
- 1 **cup water**
- 1 **medium-large Vidalia or other sweet onion (8 ounces), thinly sliced**
- ½ **cup toasted walnuts**
- ½ **cup medium packed Italian (flat) parsley leaves**
- 1 **large clove garlic, peeled**
- 1 **small shallot (½ ounce), peeled**
- 3 **tablespoons Champagne vinegar (or white balsamic vinegar)**
- ½ **teaspoon Dijon-style mustard**
- ½ **teaspoon honey**
- ½ **teaspoon kosher salt**
- ¼ **teaspoon freshly ground pepper**
- 6 **tablespoons mild-flavored extra virgin olive oil**
- 3 **ounces feta cheese, crumbled**

Place beets on rack/trivet with water in the cooking pot of the Cuisinart™ Electric Pressure Cooker.

Cover and lock lid into place. Select High Pressure and set timer for 25 minutes. When audible beep sounds use Quick Pressure Release to release pressure. When float valve drops, remove lid carefully, tilting away from you to allow steam to disperse. Test beets with a tip of a paring knife. If knife does not

pierce beet easily, select Simmer and cook until beets are done. Once beets are done remove and reserve until cool.

When beets are cool enough to handle, peel and cut into ½-inch dice and place in large mixing bowl with sliced onions.

Place walnuts in work bowl of food processor fitted with metal chopping blade, pulse to chop about 5 times; remove and reserve. Place parsley in work bowl, pulse to chop, about 15 times; remove and reserve. With machine running, drop garlic and shallot down small feed tube and process to chop finely, about 5 seconds. Scrape work bowl. Add vinegar, mustard, honey, salt, and pepper. With machine running add oil slowly through small feed tube and process until emulsified, about 15 seconds; remove and reserve.

Toss vinaigrette with reserved beets and onions. Arrange in a decorative bowl and sprinkle with remaining parsley, crumbled feta, and chopped toasted walnuts. Serve as is or on a bed of baby greens and spinach that has been tossed with remaining vinaigrette.

*Nutritional information per serving
(based on 12 servings):*

*Calories 154 (57% from fat) • carb. 13g • pro. 4g
• fat 10g • sat. fat 2g • chol. 6mg • sod. 455mg
• calc. 61mg • fiber 2g*

Risotto Primavera

Makes about 8 cups (4 entrée servings,
8 first-course servings)

- 1 **tablespoon extra virgin olive oil**
- 1 **tablespoon unsalted butter**
- ½ **cup finely chopped shallots or onions**
- ½ **cup finely diced (½-inch) carrots**
- ¼ **cup finely diced (½-inch) celery**
- 1 **clove garlic, peeled and finely chopped**
- 2 **teaspoons basil**
- 2 **cups Arborio rice**
- ½ **cup dry white wine or vermouth**
- 1 **teaspoon kosher salt**
- 5 **cups low-sodium chicken or vegetable broth/stock, divided**
- ½ **pound asparagus, cut into 1-inch lengths**
- 1 **cup peas (fresh or frozen**

thawed)

- 1 **cup shredded snow peas**
- 1 **cup diced zucchini (remove and discard seeds before dicing)**
- 1 **cup shredded Fontina cheese**
- ¼ **cup freshly grated Parmesan or Asiago cheese**
- ½ **cup chopped fresh parsley**

Place the oil and butter in the cooking pot of the Cuisinart™ Electric Pressure Cooker. Select Sauté and let oil and butter heat for 2 to 3 minutes. Add the chopped shallots, carrots, celery, garlic, and basil. Cook, stirring occasionally, until shallots are translucent and vegetables become aromatic, about 2 to 3 minutes. Stir in Arborio rice and cook, stirring frequently, until rice becomes opaque, about 3 to 4 minutes. Add wine and salt; stir and cook for 2 to 3 minutes until the rice has absorbed the wine. Add 4½ cups of the broth/stock and stir. Cover and lock lid in place. Select High Pressure and set timer for 6 minutes. When audible beep sounds use Quick Pressure Release to release pressure. Turn off. When float valve drops, remove lid carefully, tilting away from you to allow steam to disperse.

Select Simmer. Add remaining ½ cup of broth/stock to rice and stir. Cook, uncovered, stirring occasionally for 1 to 2 minutes. Stir in asparagus, peas, snow peas, and zucchini. Cook, stirring, until vegetables are bright green and crisp tender to taste. Stir in cheeses and cook 1 minute.

Serve in warmed soup plates and sprinkle with fresh parsley. If desired pass more grated Parmesan or Asiago.

*Nutritional information per serving
(based on 4 servings):*

*Calories 281 (37% from fat) • carb. 26g • pro. 12g
• fat 12g • sat. fat 6g • chol. 31mg • sod. 843mg
• calc. 193mg • fiber 2g*

Risotto with Shrimp, Sugar Snap Peas & Tarragon

Makes about 8 cups (4 entrée servings,
8 first course servings)

- 1 **tablespoon extra virgin olive oil**
- 1 **tablespoon unsalted butter**
- ½ **cup finely chopped shallot
or onion**
- ½ **cup finely diced (½-inch) carrot**
- 1 **clove garlic, peeled and finely
chopped**
- 2 **teaspoons tarragon**
- 2 **cups Arborio rice**
- ½ **cup dry white wine or vermouth**
- 1 **teaspoon kosher salt**
- 5 **cups low-sodium chicken or
vegetable broth/stock, divided**
- 1½ **pounds medium (31-40 count)
shrimp, peeled and deveined**
- ¾ **pound sugar snap peas, tipped
and topped, strings removed
shaved manchego cheese or
lemon wedges/slices
fresh tarragon sprig for garnish,
optional**

Place the oil and butter in the cooking pot of the Cuisinart™ Electric Pressure Cooker. Set on Sauté and let oil and butter heat for 2 to 3 minutes. When hot, add the chopped shallots, carrots, garlic, and tarragon. Cook, stirring occasionally, until shallots are translucent and vegetables become aromatic, about 2 to 3 minutes. Stir in Arborio rice and cook, stirring frequently, until rice becomes opaque, about 3 to 4 minutes. Add wine and salt; stir and cook for 2 to 3 minutes until the rice has absorbed the wine. Add 4½ cups of the broth/stock and stir. Cover and set on High Pressure for 6 minutes. When done cooking use Quick Pressure Release to release pressure. Remove lid carefully, tilting away from you to allow steam to disperse.

Set on Simmer. Add remaining ½ cup of broth/stock to rice and stir. Cook, uncovered, stirring occasionally for 3 to 4 minutes. Stir in shrimp. Cook, stirring, until shrimp begin to curl and turn pink, about 1½ to 2 minutes. Stir in sugar snap peas and cook for 1 minute longer, until peas are bright green and crisp tender.

Serve in warmed soup plates with either shaved manchego cheese or lemon slices. If desired, garnish each plate with a sprig of fresh tarragon.

Nutritional information per serving

(based on 4 servings):

Calories 288 (18% from fat) • carb. 25g • pro. 29g • fat 5g • sat. fat 2g • chol. 226mg • sod. 883mg • calc. 69mg • fiber 1g

Pesto Chicken with Potatoes & Carrots

Dinner all in one pot – add a green salad and a warmed loaf of crusty bread to make this meal complete.

Makes 4 servings

- 3 **pounds chicken thighs, bone in,
skin removed, trimmed of all
visible fat**
- ½ **tablespoon extra virgin olive oil**
- ⅓ **cup prepared pesto**
- ½ **cup chicken stock**
- 1 **large (6-8 ounce) onion, peeled,
cut vertically into ½-inch slices**
- 8 **2-inch new red potatoes (about
1½ pounds), scrubbed –
with a strip peeled off on the
circumference**
- 1 **pound baby-cut carrots**

Toss chicken thighs with olive oil to coat. Select Browning and let cooking pot of the Cuisinart™ Electric Pressure Cooker heat for 2-3 minutes. Add 4 thighs to the pot. Brown for about 3 minutes on each side. Remove to a bowl and repeat with remaining chicken. Turn off. Add pesto to chicken and toss to coat.

Add chicken stock and onions to the cooking pot. Insert the trivet/rack in the pot. Arrange the pesto-coated chicken on the rack. Top with new potatoes and carrots. Cover and lock lid in place. Select High Pressure and set timer for 11 minutes. When audible beep sounds, use Quick Pressure Release to release pressure. When float valve drops, remove lid carefully, tilting away from you to allow steam to disperse.

Leave on Keep Warm until ready to serve. Use a slotted spoon to transfer to warmed serving dish. Strain liquid in a fat strainer to remove fat, or use a fat mop. Serve hot.

Nutritional information per serving:
Calories 467 (43% from fat) • carb. 19g • pro. 47g
• fat 22g • sat. fat 6g • chol. 155mg • sod. 282mg
• calc. 104mg • fiber 6g

Chicken with Herb Dumplings

Old-fashioned comfort food in just a little bit of time.

Makes 4 servings

- ¼ cup unbleached all-purpose flour
- 1½ teaspoons kosher salt, divided
- ½ teaspoon freshly ground black pepper
- 8 skinless chicken thighs (about 3 pounds), bone in, trimmed of all visible fat
- 2 tablespoons unsalted butter
- 1½ cups chopped onion
- 1 cup sliced celery
- 1 teaspoon dry thyme or fines herbes
- 12 ounces baby cut carrots
- 2½ cups low-sodium chicken stock or broth
- ½ cup dry white wine
- 2-3 sprigs fresh parsley
- 1 bay leaf
- 1 recipe Herb Dumplings (follows)

Combine flour, ½ teaspoon of the salt, and pepper. Dust chicken lightly with seasoned flour. Place half the butter in cooking pot of the Cuisinart™ Electric Pressure Cooker and select Browning. When butter is melted and bubbly, add 4 chicken thighs to the cooking pot. Cook for 3 to 4 minutes on each side to brown. Transfer to a platter and repeat with remaining chicken. Select Sauté. Add onions, celery and thyme. Cook, stirring, until onions are translucent. Stir in carrots, chicken stock/broth, and wine. Return browned chicken and any accumulated juices to the cooking pot. Lay fresh parsley over the top and tuck in bay leaf.

Cover and lock lid in place. Select High Pressure and set timer for 10 minutes. While chicken is cooking, prepare Herb Dumplings. When audible beep sounds, use Quick Pressure Release to release

pressure. When float valve drops, remove lid carefully, tilting away from you to allow steam to disperse. Remove and discard parsley sprigs and bay leaf.

Select Sauté. When chicken mixture begins to bubble, arrange dumplings on top. Cover loosely (do not lock lid in place), and cook for 10 to 15 minutes, until dumplings are puffed and cooked through. Serve hot.

Nutritional information per serving (including dumplings):
Calories 732 (50% from fat) • carb. 102mg
• pro. 90g • fat 15g • sat. fat 12g • chol. 412mg
• sod. 248mg • calc. 425mg • fiber 8g

Herb Dumplings

Makes 8 dumplings

- 2 cups unbleached all-purpose flour
- 1 tablespoon baking powder
- ½ teaspoon salt
- 5 tablespoons unsalted butter
- 1 large egg, lightly beaten
- ¾ cup buttermilk

Place flour, baking powder, and salt in a medium bowl; stir to combine. Use a pastry blender or 2 forks to cut in butter until mixture resembles a coarse meal. (This may also be done in a food processor fitted with the metal chopping blade.)

Stir in egg and buttermilk, and mix until the dough just comes together. Place on a floured surface and dust with flour. Using floured hands, turn and fold 4 times. Pat out to a 1-inch thickness. Cut into 8 equal pieces.

This recipe may also be used to make biscuits. Roll out to ¾-inch thickness and cut into 12 pieces. Bake on a parchment lined baking sheet in a preheated 400°F oven for 18 to 22 minutes.

Nutritional information per serving (2 dumplings):
Calories 377 (40% from fat) • carb. 47g • pro. 10g
• fat 17g • sat. fat 10g • chol. 94mg • sod. 619mg
• calc. 290mg • fiber 2g

Curried Chicken Salad with Apples & Toasted Almonds

Prepare this summertime favorite without heating up the kitchen!
Use our recipe or your own favorite.

Makes 6 to 8 servings

- 1 medium onion, peeled and quartered
- 1 carrot, peeled and cut into 1-inch pieces
- 1 rib celery, cut into 1-inch pieces
- 8 peppercorns
- 1 cup water or low-sodium chicken broth/stock
- 3 pounds chicken breast halves, bone in, skin on
- ¾ cup lowfat mayonnaise – or more to taste
- 2-3 tablespoons curry powder
- ½ teaspoon kosher salt
- ½ teaspoon freshly ground black pepper
- 2 cups diced apples (½-inch dice) or 1 cup apples + 1 cup halved grapes
- 1 cup sliced celery
- 1 cup toasted slivered almonds
- 2 tablespoons finely chopped onion or shallot

Place onion, carrot, celery, peppercorns and water or broth in cooking pot of the Cuisinart™ Electric Pressure Cooker. Insert trivet/rack in cooking pot, and arrange chicken on rack. Cover and lock lid in place. Select High Pressure and set timer for 9 minutes. When audible beep sounds, use Natural Pressure Release for 10 minutes, then release any remaining pressure using Quick Pressure Release. Transfer chicken to a bowl. Strain liquid and pour over chicken. Allow chicken to cool in cooking liquid.

To prepare chicken salad, remove chicken from cooking liquid. (If chilled, the liquid will have congealed – it has wonderful flavor; save for other recipes using chicken stock. It may be frozen.) Remove and discard skin and bones. Cut or tear the chicken into ½-inch pieces and reserve.

Place mayonnaise, curry powder, salt, and pepper in a large bowl and stir with a whisk.

Add the apples (and grapes if using), celery, toasted almonds, and onions/shallots. Stir well. Add cut/shredded chicken and stir to combine. Cover and chill until ready to serve.

Nutritional information per serving

(based on 8 servings):

*Calories 381 (53% from fat) • carb. 14g • pro. 32g
• fat 23g • sat. fat 3g • chol. 83mg • sod. 364mg
• calc. 91mg • fiber 4g*

Green Chicken Chili

Makes about 10 cups

- 1 cup dried pinto beans
- 5 cups water
- ½ tablespoon unsalted butter
- ½ tablespoon olive oil
- 1 medium onion, finely chopped
- 1 medium carrot, peeled and chopped
- 2 medium red peppers
- 2 jalapeño peppers
- 4 cloves garlic, finely chopped
- 4 cans (4 ounces each) chopped green chile peppers
- 1 chipotle pepper
- 3 pounds chicken – mix of breasts and thighs, skin removed
- 4 cups chicken broth
- ¼ teaspoon kosher salt
- 2 tablespoons unsalted butter, softened
- 2 tablespoons unbleached all-purpose flour

Place dried pinto beans and water in cooking pot of the Cuisinart™ Electric Pressure Cooker. Select High Pressure. Set timer for 15 minutes. When audible beep sounds use Natural Pressure Release to release pressure. When float valve drops, remove lid carefully, tilting away from you to allow steam to disperse. Test beans; if they need more cook time, select simmer until they reach desired doneness. Remember beans will be heated again in the chile.

Strain beans and reserve. Wash and dry cooking pot.

Place butter and oil in the cooking pot. Select Sauté. Once butter and oil begin to sizzle, stir the chopped onions into the pot. Sauté for about a minute or 2, until onions start getting soft. Stir in the carrot. Sauté for about 3 minutes, stirring occasionally. Stir

in the chopped red and jalapeño peppers. Continue sautéing for about 4 to 5 minutes, until all vegetables are softened. Stir in the garlic and sauté for one more minute. Stir in green chiles and chipotle pepper.

Add chicken, broth, and salt. Select High Pressure and set timer for 7 minutes. When audible beep sounds, allow Natural Pressure Release for 5 minutes and then use Quick Release Method to release remaining pressure. When float valve drops, remove lid carefully, tilting away from you to allow steam to disperse.

Remove chicken pieces and reserve in a stainless bowl. When chicken is cool enough to handle, remove and discard bones and skin. Chop or shred chicken and return to pot. Select Browning.

Combine softened butter and flour. When mixture comes to a boil, whisk in flour/butter mixture to thicken the chile.

Serve immediately. May be served with shredded Cheddar cheese and sliced avocado.

Nutritional information per serving (one cup):
Calories 248 (42% from fat) • carb. 8g • pro. 27g
• fat 11g • sat. fat 5g • chol. 89mg • sod. 332mg
• calc. 41mg • fiber 1g

Turkey Chili

Makes about 8 cups

- 2 tablespoons extra virgin olive oil
- 3 pounds ground turkey (6-7% fat)
- 2 cups chopped onion
- 1 red or yellow bell pepper, cut into ½-inch dice
- 4 cloves garlic, peeled and chopped
- 3 tablespoons chili powder
- 1½ teaspoons ground cumin
- 1 teaspoon ground allspice
- 1 teaspoon ground cinnamon
- 1 teaspoon ground coriander
- 1 teaspoon oregano
- 2 cans (14-15 ounces each) diced tomatoes with juices
- ¼ cup low-sodium chicken broth or stock
- 1 teaspoon kosher salt, or to taste
- 1 bay leaf
- 2 tablespoons cornmeal

Add 1 tablespoon of the oil to the cooking pot of the Cuisinart™ Electric Pressure Cooker. Select Browning and let oil heat for 3 to 4 minutes. When oil is hot, cook the ground turkey about ½ pound at a time, adding more oil as needed, breaking up meat with a wooden spatula, until browned, about 3 to 5 minutes. Move meat as little as possible while browning for best results. Remove to a bowl as meat is browned. Turn off. Select Sauté. Add chopped onion, pepper, and garlic to the cooking pot. Cook, stirring for 2 to 3 minutes until the onion becomes translucent. Stir in the chili powder, cumin, allspice, cinnamon, coriander and oregano. Cook for 2 to 3 minutes until aromatic. Stir in reserved meat, tomatoes, chicken broth/stock, salt, and bay leaf.

Cover and lock lid in place. Select High Pressure and set timer for 10 minutes. When audible beep sounds, use Natural Pressure Release. When float valve drops, turn off and remove lid, tilting away from you to allow steam to disperse. Stir cornmeal into chili and select Simmer. Simmer chili for 10 to 15 minutes to allow the cornmeal to thicken it.

Remove and discard bay leaf before serving.

Nutritional information per serving (one cup):
Calories 355 (50% from fat) • carb. 14g • pro. 14g
• fat 22g • sat. fat 1g • chol. 110mg • sod. 289mg
• calc. 51mg • fiber 4g

Meat Sauce for Pasta

Makes about 10 cups

- 2-3 tablespoons good quality olive oil
- 2 pounds lean ground beef
- 1½ cups chopped onion
- ¾ cup finely chopped carrot
- ⅓ cup finely chopped celery
- 2 cloves garlic, peeled
- 2 teaspoons basil
- ½ cup dry wine (red or white)
- 3 cans (14-15 ounces each) diced tomatoes
- 1 can (6-ounce) tomato paste (salt free if available)
- ½ cup water
- 1 bay leaf
- 1 teaspoon kosher salt

Add 1 tablespoon of the oil to the cooking pot of the Cuisinart™ Electric Pressure Cooker. Select Browning and let oil heat for 3 to 4 minutes. When oil is hot, cook

the ground beef in 4 batches, breaking up meat with a wooden spatula, until browned, about 3 to 5 minutes. Move meat as little as possible while browning for best results. Remove to a bowl as meat is browned. Turn off. Select Sauté. Add chopped onion, carrots, celery, garlic and basil to the cooking pot. Cook, stirring for 2 to 3 minutes until the onion becomes translucent and the basil becomes aromatic. Stir in wine and cook for 2 to 3 minutes to reduce by about half. Add the tomatoes, tomato paste, water, bay leaf, and salt to the cooking pot and stir. Return the ground beef and any accumulated juices to the cooking pot. Turn off.

Cover and lock lid in place. Select High Pressure and set timer for 20 minutes. When audible beep sounds, use Natural Pressure Release. When float valve drops, remove lid, tilting away from you to allow steam to disperse. Stir. Remove and discard bay leaf before serving.

Serve with your favorite pasta and freshly grated Parmesan cheese.

Nutritional information per serving (one cup):
Calories 199 (44% from fat) • carb. 13g • pro. 14g
• fat 10g • sat. fat 3g • chol. 41mg • sod. 345mg
• calc. 47mg • fiber 3g

Mediterranean Brisket of Beef

This preparation is also delicious using a pot roast cut of meat such as bottom round or rump roast.

Makes 4 servings

- 1 **beef brisket, about 2½ to 3 pounds**
- 1 **teaspoon kosher salt**
- 1 **teaspoon freshly ground pepper**
- 1 **tablespoon extra virgin olive oil**
- 1 **pound onions, peeled, cut into ½-inch lengthwise slices**
- 3 **cloves garlic, peeled and chopped**
- 12 **ounces white button or cremini mushrooms, cleaned and halved**
- 1 **teaspoon thyme**
- 1 **teaspoon basil**
- 1 **can (15-ounce) diced tomatoes, drained (discard liquid)**
- ½ **cup low-sodium beef broth**

or stock

1 **pound baby-cut carrots**

Use a sharp knife to score the “fat cap” of the meat (do not remove the fat, it helps to keep the meat moist and tender) so that it will not curl when browned. Season the meat on both sides with the kosher salt and pepper. Select Browning and add olive oil to the cooking pot of the Cuisinart™ Electric Pressure Cooker. When hot, brown seasoned brisket on both sides, about 5 minutes per side. Remove and place on a plate. Select Sauté and add onions and garlic. Cook for 2 to 3 minutes. Add the mushrooms, thyme and basil. Cook, stirring for 5 minutes. Stir in the drained tomatoes and stock; cook for 4 to 5 minutes. Add the browned brisket to the cooking pot, topping it with some of the vegetable mixture. Add carrots on top. Cover and lock lid in place. Select High Pressure and set timer for 55 minutes. When audible beep sounds, use Natural Pressure Release to release pressure. When float valve drops, remove lid carefully, tilting away from you to allow steam to disperse.

To serve, remove the brisket and vegetables and arrange on a warm platter. Cover loosely with foil. Strain the fat from the pan juices or remove with a fat mop. Sauce can be served as is, or for a slightly thicker sauce, select Simmer and cook sauce for 5 to 10 minutes. After the brisket has rested for about 10 minutes, slice thinly and serve with sauce and vegetables.

Nutritional information per serving:
Calories 355 (21% from fat) • carb. 15g • pro. 54g
• fat 8g • sat. fat 2g • chol. 98mg • sod. 481mg
• calc. 58mg • fiber 4g

For Mediterranean Pot Roast:

Substitute a 3- to 3½-pound bottom round roast (pot roast) for the brisket. Follow instructions for browning and preparing the vegetables, but do not add carrots. Select High Pressure and set timer for 99 minutes. When audible beep sounds, use Natural Pressure Release to release pressure. When float valve drops, remove lid carefully, tilting away from you to allow steam to disperse.

Add carrots to cooking pot. Select High Pressure and set timer for 8 minutes. When audible beep sounds, use Quick Pressure Release to release pressure. When float valve drops, remove lid carefully, tilting away from

you to allow steam to disperse. To serve, follow directions for brisket.

Classic Beef Stew

Makes 8 cups

- 3 **pounds beef chuck roast, cut into 1½ to 2-inch pieces**
- kosher salt**
- fresh ground pepper**
- 2 **teaspoons olive oil**
- 1 **medium onion, finely chopped**
- 1 **medium carrot, finely chopped**
- 1 **celery stalk, finely chopped**
- 2 **garlic cloves, finely chopped**
- 1 **cup dry red wine**
- 2 **tablespoons tomato paste**
- 1 **bay leaf**
- ¾ **cup beef broth**
- 2 **cups baby-cut carrots**
- 1 **tablespoon unsalted butter, softened**
- 1 **tablespoon unbleached all-purpose flour**
- 1 **cup frozen peas**

Season pieces of chuck roast with salt and pepper and reserve. Place the olive oil in the cooking pot of the Cuisinart™ Electric Pressure Cooker. Select Browning. When oil begins to sizzle, add pieces of chuck in a single layer – do not crowd. Continue browning meat in batches until all meat is browned. As meat is browned transfer to a plate. Select Sauté. Stir the chopped onions into the pot. With a wooden spoon scrape any brown bits from the bottom of the pan that have accumulated while meat was browning. Sauté for 1 to 2 minutes, until onions start to soften and are translucent. Stir in the carrots and celery. Sauté vegetables for about 3 minutes, stirring occasionally. Stir in the chopped garlic and Sauté for an additional minute.

Once vegetables are soft, stir in red wine, again scraping any brown bits that have accumulated on the bottom of the pot. Cook until red wine has reduced by half, then stir in the tomato paste.

Add the reserved beef, bay leaf, and beef broth to the pot. Select High Pressure. Set timer for 10 minutes. When audible beep sounds use Quick Pressure Release to release pressure. When float valve drops, remove lid carefully, tilting away from you to

allow steam to disperse. Add carrots to the pot and select High Pressure. Set timer for 6 minutes. When audible beep sounds use Natural Pressure Release to release pressure. When float valve drops, remove lid carefully, tilting away from you to allow steam to disperse.

To thicken stew, strain the solids from the stew liquid, reserving both. Remove and discard bay leaf. Blend softened butter and flour to make a paste (*buerre manié*). Return liquid to pot and bring to a boil by selecting Brown. Once liquid comes to a bowl whisk in the butter/flour mixture. Select Simmer. Once liquid thickens, stir the meat and carrots back into the pot. Taste and adjust seasonings with salt and pepper accordingly. Just before serving, stir in peas.

Nutritional information per serving (1½ cups):
Calories 340 (32% from fat) • carb. 16g • pro. 35g
• fat 11g • sat. fat 4g • chol. 103mg • sod. 98 mg
• calc. 49mg • fiber 4g

Boneless Veal Shoulder Roast Stuffed with Sage Mushrooms

Makes 6 servings

- 8 **ounces cremini or button mushrooms, thinly sliced**
- 4 **ounces shiitake mushrooms, stems removed & discarded, thinly sliced**
- ½ **cup chopped shallots**
- 1 **clove garlic, peeled**
- 1 **tablespoon rubbed sage, divided**
- 2 **tablespoons olive oil, divided**
- ½ **tablespoon unsalted butter**
- 5 **tablespoons unbleached all-purpose flour, divided**
- 1 **teaspoon kosher salt**
- ½ **teaspoon freshly ground black pepper**
- 1½ **cups chicken or veal stock/ broth, divided**
- 1 **boneless veal shoulder roast, butterflied, about 3 to 3½ pounds**
- 4 **ounces thinly sliced prosciutto (you may not need all)**
- ½ **cup finely chopped onion**
- ⅓ **cup finely chopped carrot**
- ⅓ **cup finely chopped celery**
- 1 **clove garlic, cut into slivers**
- ¼ **cup dry white wine or vermouth**

Cook mushrooms, shallots, and garlic with 2 teaspoons of the sage in ½ tablespoon each butter and olive oil in 12-inch skillet, until browned and have given up all liquid, about 15 to 20 minutes. Stir in remaining sage. Let cool completely. Combine 3 tablespoons of the flour with ½ teaspoon of the salt and all the pepper; reserve. Combine remaining 2 tablespoons of the flour with 1 cup of the chicken broth/stock and stir with a whisk.

Place veal roast on work surface, cut side up. Line cut side with prosciutto, leaving an overhang on opposite sides of the center of about 4 inches. Arrange all but ¼ cup of the cooled cooked mushroom mixture over the center of the prosciutto where the overhangs are. Fold the lengths of prosciutto over the mushroom mixture, then roll and tie the roast with butcher's twine at one-inch intervals. Dust the roast with the seasoned flour mixture.

Select Browning and heat the remaining olive oil in the cooking pot of the Cuisinart™ Electric Pressure Cooker. When hot, add the roast and brown on all sides, about 10 to 15 minutes. Remove and reserve. Select Sauté and add chopped onion, carrot, celery, garlic, reserved mushroom mixture, and remaining salt to the pan. Cook for 2 to 3 minutes until the onion becomes translucent. Add the remaining ½ cup of chicken stock to the cooking pot along with the wine. Place the trivet/rack in the cooking pot and arrange the roast on the rack. Cover and lock lid in place. Select High Pressure and set timer for 10 minutes per pound (the roast weight before stuffing, i.e., if roast weighs 3.30 pounds, set timer for 33 minutes – the weight is important so that roast will not be overcooked). When audible beep sounds, use Natural Pressure Release to release pressure. Turn off. When float valve drops, remove lid carefully, tilting away from you to allow steam to disperse. Remove roast, place on a platter and cover loosely with foil.

Use a hand blender to carefully purée solids in cooking pot until smooth, taking care not to scratch the nonstick cooking pot. Select Simmer. Add the stock/flour mixture and simmer until slightly thickened. About 5 to 10 minutes, just long enough for the roast to rest before slicing.

Slice roast into ½-inch thick slices and serve with sauce.

Nutritional information per serving:
Calories 325 (32% from fat) • carb. 13g • pro. 40g

• fat 11g • sat. fat 3g • chol. 135mg • sod. 721mg
• calc. 50mg • fiber 135mg

Veal Shanks with Mushrooms & Sun-Dried Tomatoes

Makes 6 servings

- ½ cup unbleached all-purpose flour
- 2 teaspoons kosher salt, divided
- 1 teaspoon freshly ground black pepper, divided
- 6 meaty veal shanks, about 10 to 12 ounces each, cross-cut about 1¼ to 1½-inches thick, tied with butcher's twine*
- 2 tablespoons extra virgin olive oil
- 12 ounces cremini mushrooms, cleaned and quartered
- ½ cup chopped shallot
- ½ cup chopped carrot
- ¼ cup chopped celery
- 1 tablespoon herbes de Provence
- ½ cup dry white wine or vermouth
- ½ cup sun-dried tomato halves (dry, not oil packed)
- ⅓ cup low-sodium chicken broth or stock

Combine flour with 1 teaspoon of the salt and ½ teaspoon of the pepper. Dust veal shanks with seasoned flour, shaking off excess.

Select Browning and add 1 tablespoon of the olive oil to the cooking pot of the Cuisinart™ Electric Pressure Cooker. When the oil is hot, add 2 of the veal shanks to the pot and brown well on each side, about 3 to 5 minutes per side. Remove to a platter and continue until all are browned.

Add the remaining olive oil to the cooking pot and when hot, add the mushrooms. Cook for several minutes until nicely browned. Turn off. Select Sauté. Add the shallot, carrot, celery and herbes de Provence. Cook for 2 to 3 minutes, until the shallots are translucent. Add wine and reduce by half. Stir in the sun-dried tomatoes and chicken stock. Remove about two thirds of the vegetable mixture from the cooking pot and reserve. Arrange the veal shanks in the cooking pot in 2 layers. Spoon the reserved vegetables over the veal and add any juices that may

have accumulated on the platter. Cover and lock lid in place. Select High Pressure and set timer for 25 minutes. When audible beep sounds, use Natural Pressure Release for 15 minutes, and then use Quick Pressure Release to complete. When float valve drops, turn off. Remove lid, tilting away from you to allow steam to disperse.

Remove veal shanks and place on a serving platter. Cover loosely with foil. Season sauce with remaining salt and pepper. Select Simmer and cook the sauce for an additional 10 minutes to thicken slightly. Spoon sauce over veal to serve.

Nutritional information per serving:

*Calories 607 (20% from fat) • carb. 20g • pro. 100g
• fat 13g • sat. fat 4g • chol. 381mg • sod. 686mg
• calc. 179mg • fiber 4g*

*Tie the shanks using butcher's twine to hold the veal in shape during cooking by tying each shank around its circumference. Remove string before serving.

Veal Stifado

Makes about 8 cups

½ cup unbleached all-purpose flour
1 teaspoon kosher salt
½ teaspoon freshly ground pepper
2½ pounds veal cubes (1½-2 x 1 inch), trimmed of visible fat
2-3 tablespoons extra virgin olive oil
⅓ cup dry white vermouth or dry white wine (not Chardonnay)
½ cup finely chopped onion
3 cloves garlic, peeled and finely chopped
1½ teaspoons oregano
1½ teaspoons rosemary
1½ teaspoons thyme
1 teaspoon ground cumin
⅓ cup dry white vermouth or dry white wine (not Chardonnay)
2 cans (14-15 oz. each) diced tomatoes in thick juices
2 tablespoons red wine vinegar
1 whole cinnamon stick (3-4 inches)
1 bay leaf
1 pound small whole onions, peeled if fresh, thawed if frozen
chopped fresh parsley and cooked rice or pasta

Combine the flour, salt, and pepper in a large bowl. Toss the veal cubes in the seasoned flour to coat lightly; shake off and discard excess flour.

Add 1 tablespoon of the oil to the cooking pot of the Cuisinart™ Electric Pressure Cooker. Select Browning and let oil heat for 3 to 4 minutes. When oil is hot, cook the veal cubes in batches, leaving space between each piece of meat (to promote browning and prevent steaming) until browned, about 3 to 5 minutes on each side, adding more oil a little at a time as needed. Move meat as little as possible while browning for best results. Remove to a platter as meat is browned. Turn off. Select Sauté. Add chopped onion, garlic, oregano, rosemary, thyme, and cumin to the cooking pot. Cook, stirring for 2 to 3 minutes until the onion becomes translucent and the herbs become aromatic. Stir in the vermouth/wine and cook for 2 minutes. Add the tomatoes, vinegar, cinnamon stick, and bay leaf to the cooking pot and stir. Return the browned veal and any accumulated juices to the cooking pot. Turn off.

Cover and lock lid in place. Select High Pressure and set timer for 9 minutes. When pressure cooking is completed, use Quick Pressure Release. Add onions to cooking pot. Select High Pressure and set timer for 1 minute. Use Natural Pressure Release (about 15 to 20 minutes). Remove and discard bay leaf and cinnamon stick before serving.

Serve Stifado with rice or pasta, garnished with freshly chopped parsley.

*Nutritional information per serving (per cup):
Calories 206 (33% from fat) • carb. 12g • pro. 21g
• fat 14g • sat. fat 2g • chol. 71mg • sod. 353mg
• calc. 67mg • fiber 3g*

Braised Lamb Shanks with Artichokes & Olives

Lamb shanks are a delicious treat that benefit from long, slow cooking – but the Cuisinart™ Electric Pressure Cooker does them perfectly in less than a third of the time.

Make 4 servings

½ cup unbleached all-purpose flour
1 teaspoon kosher salt
½ teaspoon freshly ground pepper

- 4 **lamb shanks, about ¾ pound each (no more than 7 inches long)**
- 1 **tablespoon good quality olive oil**
- 1 **cup chopped onions**
- ¾ **cup diced (¼-inch) carrots**
- 2 **cloves garlic, peeled and chopped**
- 1 **tablespoon herbes de Provence**
- 1 **can (14- to 15-ounce) diced tomatoes with juices**
- ½ **cup dry white wine**
- ½ **cup low-sodium chicken, veal or beef broth or stock**
- 1 **bay leaf**
- 1 **jar (12-ounce) queen pimento-stuffed green olives, drained**
- 1 **package (9-ounce) frozen artichoke hearts, thawed but not cooked**
- kosher salt and freshly ground pepper to taste**

Combine flour, salt, and pepper. Dust lamb shanks with seasoned flour. Add olive oil to cooking pot of the Cuisinart™ Electric Pressure Cooker. Select Browning. When oil is hot, add 2 lamb shanks and brown evenly on all sides, about 5 to 10 minutes total. Remove to a platter and repeat with remaining 2 lamb shanks.

Select Sauté. Add onions, carrots, garlic, and herbes de Provence to cooking pot. Cook for 3 to 5 minutes, until onions become translucent. Stir in tomatoes, wine, stock, and bay leaf. Return lamb shanks and any accumulated juices to the cooking pot, spooning some of the liquid and vegetable mixture over the shanks. Cover and lock lid in place. Select High Pressure and set timer for 24 minutes. When audible beep sounds, allow 10 minutes Natural Pressure Release, then use Quick Pressure Release to release remaining pressure. Remove lid carefully, tilting away from you to allow steam to disperse. Remove lamb shanks to a warm platter and cover loosely with foil, place in a slow (200°F) oven to Keep Warm.

Add olives and artichokes to cooking pot. Select Simmer and cook, uncovered for 10 to 15 minutes to thicken slightly. Taste and adjust seasonings with salt and pepper. Spoon sauce over lamb shanks to serve.

Nutritional information per serving:

Calories 491 (40% from fat) • carb. 24g • pro. 42g
 • fat 22g • sat. fat 5g • chol. 132mg • sod. 1000g
 • calc. 65mg • fiber 5g

Pork Chops with Balsamic, Onions & Figs

Makes 4 servings

- 4 **pork loin chops, bone in, well trimmed of excess fat, about ¾- to 1-inch thick each**
- 1 **teaspoon kosher salt, divided**
- ½ **teaspoon freshly ground black pepper**
- ½ **tablespoon unsalted butter**
- ½ **tablespoon good quality olive oil**
- 3 **cups sliced onions (about 1 pound, peeled, sliced vertically)**
- 2 **cloves garlic, peeled and chopped**
- 1 **teaspoon thyme**
- 3 **tablespoons aged balsamic vinegar**
- 2 **tablespoons dry white wine or vermouth**
- ⅓ **cup chicken stock**
- 10 **ounces dried figs**

Season pork chops with ½ teaspoon salt and pepper. Add butter and olive oil to the cooking pot of the Cuisinart™ Electric Pressure Cooker. Select Browning. When hot add 2 pork chops and brown for 3 to 4 minutes on each side. Transfer to a plate and brown remaining 2 pork chops, transfer to the plate.

Select Sauté and add the onions, garlic and thyme to the cooking pot. Cook, stirring for 3 to 4 minutes, until onions become translucent. Add balsamic vinegar and cook until reduced by half. Add wine, chicken stock, and remaining ½ teaspoon salt. Cook for 1 minute. Return pork chops to the cooking pot, topping with some of the onion mixture. Add figs on top. Cover and lock lid in place. Select High Pressure and set timer for 9 minutes. When audible beep sounds use Quick Pressure Release to release pressure. Turn off. Remove lid carefully, tilting away from you to allow steam to disperse.

Transfer pork chops, onions and figs to a warm platter with the pan juices and serve.

If desired, cover pork chops, onions and figs loosely with a sheet of aluminum foil and place in a warm (200°F) oven. Select Simmer and reduce pan juices by half until slightly syrupy. Pour over pork chops and serve.

Nutritional information per serving:

Calories 504 (23% from fat) • carb. 62g • pro. 37g
 • fat 13g • sat. fat 5g • chol. 99mg • sod. 454mg
 • calc. 166mg • fiber 8g

Pork Barbecue

Makes 5 cups pulled pork

- 1/2 **tablespoon vegetable oil**
- 4 **pounds country style spare ribs or pork shoulder slices**
- 1 **large onion, peeled and sliced**
- 1/2 **cup cider vinegar**
- 2 **tablespoons brown sugar**
- 1 **teaspoon salt**
- 1/2 **teaspoon freshly ground black pepper**
- 2 **cups barbecue sauce (homemade or purchased)**

Add oil to cooking pot of the Cuisinart™ Electric Pressure Cooker and select Browning. When oil is hot, add pork and brown well on all sides in several batches. Add onion, vinegar, brown sugar, salt and pepper to cooking pot along with the browned pork and any juices that may have accumulated. Cover and lock lid in place. Select High Pressure and set timer for 45 minutes. When audible beep sounds, allow pressure to release naturally. Turn off.

Remove lid, tilting away from you to allow steam to disperse. Allow pork to cool in cooking liquid. When cool enough to handle, remove pork from bones, discard bones and pork fat. Strain cooking liquid, reserving 1/2 cup.

Place pork in cooking pot with barbecue sauce and reserved 1/2 cup cooking liquid. Cover and lock lid in place. Select Low Pressure and set timer for 3 minutes. When audible beep sounds, use Quick Pressure Release to release Pressure. Remove lid, tilting away from you to allow steam to disperse. Serve hot. May be served on sliced buns for a sandwich.

Nutritional information per serving (1/2 cup):
Calories 326 (49% from fat) • carb. 11g • pro. 31g
• fat 18g • sat. fat 7g • chol. 107mg • sod. 411mg
• calc. 28mg • fiber 1g

Makes 8 generous servings

- 1 **tablespoon good quality olive oil**
- 3 **pounds Italian sausage, 1 inch thick, 4 inches long, sweet or hot**
- 3 **cups sliced green bell pepper (2 x 1/2-inch slices)**
- 3 **cups sliced red bell pepper (2 x 1/2-inch slices)**
- 2 **cups sliced onions (1/2-inch thick vertical slices)**
- 2 **cloves garlic, peeled and chopped**
- 1 **tablespoon Italian herb blend**
- 1/2 **cup low-sodium chicken broth or stock**

Add olive oil to cooking pot of the Cuisinart™ Electric Pressure Cooker. Select Browning. When hot, add sausages, about 1 pound at a time – do not overcrowd – and brown on all sides, about 3 to 5 minutes. Remove and reserve each batch on a platter as they are browned.

Add peppers, onions, garlic and Italian herbs to the pot. Stir for 2 to 3 minutes. Stir in chicken stock and cook for 1 minute. Return the sausages and any accumulated juices to the cooking pot. Stir gently to mix in with the onions and peppers. Cover and lock lid in place. Select High Pressure and set timer for 4 minutes. When audible beep sounds use Quick Pressure Release to release pressure. Remove lid carefully, tilting away from you to allow steam to disperse.

Leave uncovered on Keep Warm until ready to serve.

Nutritional information per serving:
Calories 487 (68% from fat) • carb. 11g • pro. 28g
• fat 36g • sat. fat 12g • chol. 105mg • sod. 1268mg
• calc. 59mg • fiber 2g

Corned Beef with Vegetables

Makes 6 servings

- 1 **3- to 4-pound corned beef brisket with spice pack***
- 1 **cup chopped onion**
- 2 **ribs celery, including leaves, cut into 2-inch lengths**
- 1 1/2 **cups water**
- 1/4 **cup orange marmalade**
- 1/4 **cup Dijon-style mustard**

Sausages with Peppers & Onions

Serve with cooked pasta, or warmed “hero,” “hoagie,” or “grinder” rolls to make sandwiches.

- 2 tablespoons molasses**
- 1½ pounds new red potatoes, about 2 inches in size**
- 6 carrots, peeled, cut into 2-inch lengths**
- 1 cabbage (2 pounds), outer leaves removed, cut into 6 wedges**
- 6 small (2-3 ounces each), onions, peeled with root end left intact**

Rinse corned beef. Place trivet/rack in cooking pot of the Cuisinart™ Electric Pressure Cooker. Add chopped onion and celery to pot. Place corned beef on rack and add water. Cover and lock lid in place. Select High Pressure and set timer for 24 minutes per pound and round up or down to closest 5-minute increment (i.e., if corned beef weighs 3.25 pounds, multiply 3.25 x 24 to get 78 minutes – round up to 80 minutes). While corned beef cooks, combine marmalade, mustard and molasses and stir with a whisk.

When audible beep sounds, time for 20 minutes of Natural Pressure Release, the release remaining pressure using Quick Pressure Release. Preheat oven to 375°F. When float valve drops, turn Pressure Cooker off. Remove corned beef from cooking pot.

Trim the fat layer from the corned beef and discard. Place in a roasting pan and top with marmalade mixture. Place in oven to 20 to 25 minutes to glaze.

Strain cooking liquid, discarding solids and return liquid to cooking pot (it will have turned red – do not worry). Place the potatoes and carrots in the liquid in the cooking pot first, then the cabbage wedges, and top with the onions. Cover and lock lid in place. Select High Pressure and set timer for 3 minutes. When audible beep sounds, use Quick Pressure Release to release pressure. If vegetables are not cooked enough, select Simmer and cook until done to taste preference.

Using a slotted spoon or skimmer, remove the vegetables and arrange in a warmed shallow serving bowl. Slice the corned beef in thin slices across the grain to serve.

Nutritional information per serving:
Calories 640 (44% from fat) • carb. 56g • pro. 35g • fat 31g • sat. fat 10g • chol. 157mg • sod. 2501mg • calc. 210mg • fiber 12g

*Choose a flat cut or straight cut brisket. If the package does not contain a spice pack, you can prepare your own – 8 whole peppercorns, 4 whole allspice berries,

1 teaspoon mustard seed, ½ teaspoon coriander seed, and 1 bay leaf.

Lemon Cheesecake

“Bake” a cheesecake without heating up the kitchen.

Makes one 7-inch cheesecake, 6 to 8 servings

- melted unsalted butter or cooking spray for the pan**
- 6 1½-inch gingersnap cookies, crushed into crumbs**
- 1½ tablespoons finely chopped toasted almonds**
- ½ tablespoon unsalted butter, melted**
- 1 pound regular cream cheese, cut into 1-inch pieces, at room temperature**
- ½ cup granulated sugar**
- 2 large eggs**
- zest of 1 lemon, finely chopped**
- 1 tablespoon fresh lemon juice**
- 1½ teaspoons pure vanilla extract**
- Garnishes: fresh blueberries, raspberries or strawberries**

Lightly coat a 7x3-inch springform pan with melted unsalted butter or coat with cooking spray. Place a sheet of plastic wrap (about 16x16-inches) on top of a sheet of aluminum foil the same size. Place the springform pan in the center and wrap the exterior tightly.

Combine the cookie crumbs, toasted almonds and melted butter in a small bowl. Turn into the prepared pan and turn to dust the sides of the pan. Press the remainder onto the bottom of the pan. Reserve.

Place cream cheese and sugar in the work bowl of a food processor fitted with the metal “s” blade. Process until smooth, about 15 to 20 seconds. Add the eggs, lemon zest, lemon juice, and vanilla. Process for 10 seconds. Scrape down the bowl and process for another 5 seconds. (Alternatively, the cheesecake batter can be combined using a hand mixer on low speed – take care not to incorporate too much air, which will cause cracking.) Pour the batter into the prepared pan. Place the rack/trivet in the cooking pot and add 2 cups of water.

Cut a piece of aluminum foil about 24 inches long. Fold in half lengthwise, then fold in half again two more times to create a strip about 24 inches in length and 2 inches wide to make a “cradle.” Place on counter and set filled springform pan in the center. Cover cheesecake with a piece of buttered aluminum foil – making the sides tight, but allowing room for the cheesecake to expand. Bring the ends of the cradle strip upward. Use the cradle to help lower the cheesecake into the cooking pot of the Cuisinart™ Electric Pressure Cooker and place on the trivet.

Cover and lock lid in place. Select High Pressure and set timer for 8 minutes. When audible beep sounds, use natural pressure release to release pressure. Remove cheesecake from the cooking pot using the foil strips to lift up. Place on a cooling rack. Remove foil and plastic wrap. If moisture has accumulated on the top, dab gently with a paper towel to remove. Let cool to room temperature, then cover and refrigerate. Before serving remove from springform pan and garnish if desired.

*Nutritional information per serving
(based on 8 servings):*

*Calories 299 (67% from fat) • carb. 19g • pro. 6g
• fat 23g • sat. fat 14g • chol. 119mg
• sod. 214mg • calc. 59mg • fiber 0g*

Mango Coconut Bread Pudding

For a warm dessert, bread pudding can be mixed and assembled ahead, then baked while dinner is being served.

Serve with fresh raspberries or Simple Raspberry Sauce (page 35), and top with sweetened softly whipped cream, or ice cream – vanilla, ginger or coconut.

Makes 8 to 12 servings

- 1** **tablespoon unsalted butter, melted**
- 6** **cups bread cubes made from challah bread or other bread with dense texture**
- 1** **mango (about 1 pound), firm but ripe, peeled and cut into ½-inch cubes (2 cups)**
- ⅓** **cup sweetened flaked/shredded coconut**

- 5** **large eggs**
- 1½** **cups (one 12-ounce can) lowfat evaporated milk (not reconstituted)**
- 1½** **cups coconut milk**
- ½** **cup packed brown sugar**
- 2** **teaspoons pure vanilla extract**
- ½** **teaspoon ground cinnamon**
- ½** **teaspoon ground ginger**
- ½** **teaspoon ground allspice**

Coat a 2-quart ceramic soufflé dish (8-inch diameter) with the melted butter and reserve. Cut a piece of aluminum foil 16 inches square and lightly butter an 8-inch round in its center. Cut a piece of aluminum foil about 24 inches long. Fold in half lengthwise, then fold in half again two more times to create a strip about 24 inches in length and 2 inches wide to make a “cradle” and reserve.

Place the bread cubes, mango and coconut in a large bowl. Place the eggs in a medium bowl. Whisk until smooth. Add evaporated milk, coconut milk, brown sugar, vanilla, cinnamon, ginger, and allspice. Whisk to combine. Pour over the bread cube mixture and stir gently. Pour into prepared soufflé dish and let stand at room temperature for 30 minutes.

Cover with prepared sheet of foil, buttered side down, so that the foil allows for the top of the bread pudding to expand, but fits tightly around the sides of the soufflé dish. Set the dish in the center of the long strip of folded foil and bring up the sides to meet – twist together to form a handle.

Place trivet/rack in the cooking pot and add 2 cups of cold water. Using the foil cradle to help lift the dish, carefully lower the dish into the pot and place on the trivet/rack.

Cover and lock lid in place. Select High Pressure and set timer for 25 minutes. When audible beep sounds, use Natural Pressure Release to release pressure. When float valve drops, turn off. Remove lid carefully, tilting away from you to allow steam to disperse. Remove bread pudding from the cooking pot using the foil strips to lift up. Place on a cooling rack. Remove foil. Let stand 10 minutes before serving, or cool to room

temperature, then cover and refrigerate. Serve with softly whipped cream if desired.

*Nutritional information per serving
(based on 12 servings):*

Calories 206 (45% from fat) • carb. 24g • pro. 4g
• fat 10g • sat. fat 6g • chol. 109mg • sod. 125mg
• calc. 39mg • fiber 1g

Creamy Rice Pudding

Using coconut milk gives this rice pudding a hint of coconut and a very creamy texture.

Makes 6 cups

- 1½ cups Arborio or Carnaroli rice
- 2 cups whole milk
- 1 can (14-ounce) lite coconut milk
- 1 cup water
- ½ cup granulated sugar
- 2 teaspoons cinnamon
- ½ teaspoon salt
- 1½ teaspoons pure vanilla extract
- 1 cup dried tart cherries, dried cubed mango or papaya, or golden raisins

Rinse rice and drain. Place rice, whole milk, coconut milk, water, sugar, cinnamon, and salt in the cooking pot. Select Sauté and bring to a low boil, stirring constantly to dissolve the sugar. As soon as the mixture comes to a boil, cover and lock lid in place. Select Low Pressure and set timer for 15 minutes.

When audible beep sounds, use Quick Pressure Release to release pressure. Turn off. When float valve drops, remove lid carefully, tilting away from you to allow steam to disperse. Add vanilla and dried fruit and stir. Place cover on pot, but do not turn on. Let stand for 15 minutes. Stir and serve. May be garnished with a sprinkling of cinnamon and freshly whipped cream.

Nutritional information per serving (½ cup):
Calories 142 (22% from fat) • carb. 25g • pro. 3g
• fat 4g • sat. fat 2g • chol. 7mg • sod. 126mg
• calc. 72mg • fiber 1g

Ginger Steamed Pears with Vanilla Bean Mascarpone Cream

Makes 4 servings

**Vanilla Bean Mascarpone Cream
(recipe follows)**

- 1 cup medium dry sherry
- ¼ cup granulated sugar
- 2 strips lemon zest
(about 2x½ inches each)
- 1 tablespoon fresh lemon juice
- 4-5 slices fresh ginger
- 4 pears, about 8 to 10 ounces each
- ½ whole lemon
- Fresh raspberries and chocolate shavings or candied ginger for garnish**

Prepare Vanilla Bean Mascarpone Cream. Cover and refrigerate until ready to use; remove from refrigerator 30 minutes before serving.

Place sherry, sugar, lemon zest, lemon juice and ginger in the cooking pot of the Cuisinart Pressure Cooker. Select Simmer and cook until the sugar is dissolved. Remove a slice from the bottom of each pear, and use a small melon baller to remove the core. Peel the pear vertically, leaving stripes of peel on the pear. Rub cut surfaces with lemon half.

Place trivet/rack in cooking pot of the Cuisinart™ Electric Pressure Cooker. Place a heatproof 8-inch plate on the trivet and arrange pears on plate. Select High Pressure and cook for 4 minutes. When audible beep sounds, use Quick Pressure Release to release pressure. Remove pears, plate and trivet. Add any liquid that has accumulated on the plate to the cooking pot. Let pears cool, then cover and refrigerate until ready to serve. Select Simmer and cook the liquid for about 20 to 25 minutes, until it is reduced by about half (you should have slightly more than ½ cup after reducing). Strain and cool.

Place pears on individual dessert plates. Drizzle with chilled ginger syrup and garnish with a little dollop of Vanilla Bean Mascarpone Cream, fresh raspberries and chocolate shavings or candied ginger. If desired, stuff hollow of pear with Vanilla Bean Mascarpone Cream.

Nutritional information per serving (pear only):
Calories 236 (3% from fat) • carb. 48g • pro. 1g
• fat 1g • sat. fat 0g • chol. 0mg • sod. 6g
• calc. 31mg • fiber 6g

Vanilla Bean Mascarpone Cream

Makes 4 servings

- 1/2 vanilla bean
- 8 ounces mascarpone cheese, softened to room temperature
- 1 tablespoon powdered sugar
- 2 teaspoons milk
- 1/2 teaspoon pure vanilla extract

Split vanilla bean in half lengthwise. Scrape out the seeds with the back of a knife. Place vanilla seeds, cheese, sugar, milk, and vanilla in a small bowl. Stir with a whisk until smooth (this may also be done with a hand mixer, hand blender or food processor). Refrigerate until ready to use. Remove from refrigerator 30 minutes before using to soften.

Nutritional information per serving:
Calories 269 (91% from fat) • carb. 2g • pro. 4g
• fat 26g • sat. fat 14g • chol. 70mg • sod. 31mg
• calc. 83mg • fiber 0g

Simple Raspberry Sauce

Makes about 2 cups

- 12 ounces fresh or frozen, thawed strawberries or raspberries
- 1 cup red berry preserves
- 1 tablespoon sugar
- 1 tablespoon fresh lemon juice

Place all ingredients in Cuisinart® Food Processor fitted with the metal “s” blade. Process until smooth and completely puréed, about 1 minute. Strain mixture through a fine sieve to remove seeds; discard seeds. Store in an airtight container in refrigerator. Serve with desserts, pancakes or waffles.

Nutritional information per serving (based on 8 servings):
Calories 128 (0% from fat) • carb. 33g • pro. 1g
• fat 0g • sat. fat 0g • chol. 0mg • sod. 5mg
• calc. 14mg • fiber 2g

Version no: CPC600 Series IB-7077G

Size: 140 mm (W) X 216 mm (H)
Total Pages: 44 pps

Material:
Cover: 157gsm matt artpaper
Inside: 120gsm gloss artpaper

Coating: GLOSS VARNISHING IN COVER

Color:
Cover: 4C+1C(K)
Inside: 1C+1C(K) with one color page.

Die cut: New

Bar Code:

Date: 02/26/13 (01)

Coordinator: Astor You / Scias Liu

 CHUNG TAI PRINTING HOLDINGS LTD.
中大印刷集團有限公司

Tel: 2669 6173

Fax: 2677 6556

