

Panasonic®

Owner's Manual <Full version> Wireless Speaker System

Model No. SC-ALL8
SC-ALL3

SC-ALL8

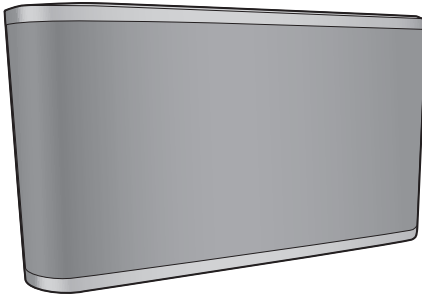

SC-ALL3

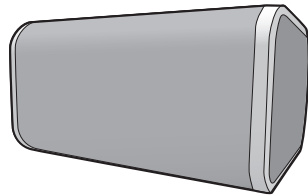

Thank you for purchasing this product.
Please read these instructions carefully before using this product,
and save this manual for future use.

Register online at www.panasonic.com/register (U.S. customers only)

SQT0179



Table of contents

Accessories	3
Unit care	4
Control reference guide.....	5
Indicator illumination	6
SC-ALL3 Installation	9
Connections	10
Network settings.....	12
Enjoying music.....	20
Firmware updates	24
Others	25
SC-ALL8 Attaching to a wall (optional)	27
Troubleshooting.....	30
Specifications	33

How to use this manual

-  Click/Tap this icon to jump to “Table of contents”.
- Pages to be referred to are indicated as “→ ○○”. You can jump to the corresponding page by clicking/tapping this.



Accessories

1 AC power supply cord (AC mains lead)

For the U.S.A. and Canada
(K2CB2CB00022)

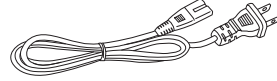

For the United Kingdom and Ireland
(K2CT2YY00097)

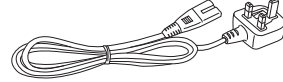

For Continental Europe
(K2CQ2YY00119)

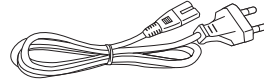

For Australia and New Zealand
(K2CJ2YY00101)

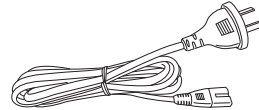

SC-ALL8

Wall mounting accessories

1 Screw
(XTB3+8JFJK-J)



1 Safety holder
(RSC1266)

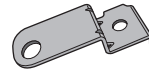

2 Wall mount brackets
(RSC1262-1)

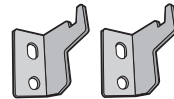

- Do not use AC power supply cord (AC mains lead) with other equipment.
- Product numbers provided in this owner's manual are correct as of May 2014. These may be subject to change.



Unit care

Clean this unit with a soft, dry cloth.

- When cleaning the speaker covers, use a fine cloth. Do not use tissues or other materials that can fall apart. Small pieces may get stuck inside the speaker cover.
- Never use alcohol, paint thinner or benzine to clean this unit.
- Before using chemically treated cloth, carefully read the cloth's instructions.

■ To dispose or transfer this unit

The unit may keep the user settings information in the unit. If you discard this unit either by disposal or transfer, then follow the procedure to return all the settings to the factory defaults to delete the user settings.

(→ 30, “To return all settings to the factory defaults”)

- The operation history may be recorded in the memory of this unit.

Disposal of Old Equipment Only for European Union and countries with recycling systems



This symbol on the products, packaging, and/or accompanying documents means that used electrical and electronic products must not be mixed with general household waste.

For proper treatment, recovery and recycling of old products, please take them to applicable collection points in accordance with your national legislation.

By disposing of them correctly, you will help to save valuable resources and prevent any potential negative effects on human health and the environment.

For more information about collection and recycling, please contact your local municipality.

Penalties may be applicable for incorrect disposal of this waste, in accordance with national legislation.



Control reference guide

SC-ALL8

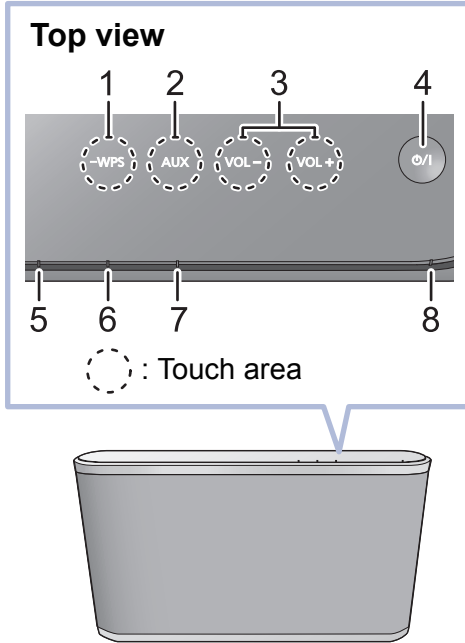

SC-ALL3

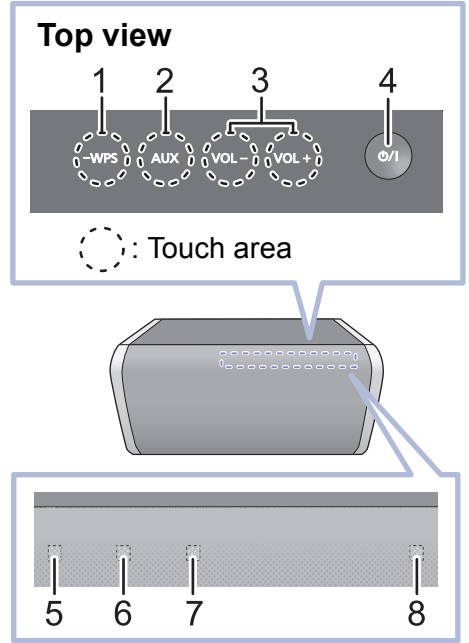





- 1 WPS pairing switch [-WPS]
Enter WPS pairing mode (→ 17) / firmware update mode (→ 24)
- 2 Selector switch [AUX]
Select AUX as the audio source (→ 23)
- 3 Volume control switch [VOL -]/[VOL +]
- 4 Standby/on switch [⏻/⏻]
Touch to switch the unit from on to standby mode or vice versa. In standby mode, the unit is still consuming a small amount of power.
- 5 Mode indicator (amber)
- 6 Network indicator (blue/red)
- 7 AUX indicator (green)
- 8 Operation indicator (amber)





Indicator illumination





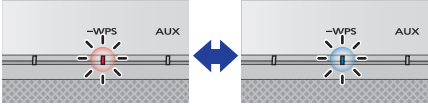
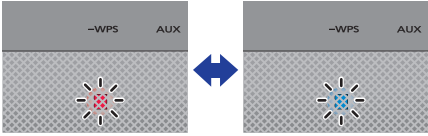
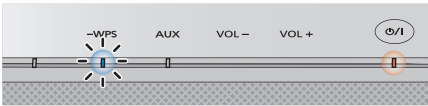

The indicator patterns illustrated below are displayed during normal operational conditions.

Indicator	Description
<p>Operation indicator (amber)</p> <p>SC-ALL8</p>  <p>SC-ALL3</p> 	<p>Blinks once</p> <ul style="list-style-type: none">• The unit detects the switch touched. <p>Blinks twice</p> <ul style="list-style-type: none">• The unit detects a valid operation performed by touching and holding the switch. <p>Blinks</p> <ul style="list-style-type: none">• Automatic standby mode is activated. (→ 10)
<p>Mode indicator (amber)</p> <p>SC-ALL8</p>  <p>SC-ALL3</p> 	<p>Blinks once</p> <ul style="list-style-type: none">• The following setting is turned on.<ul style="list-style-type: none">“Network standby” (→ 16)“Operation sound setting” (→ 25)– When the setting is turned off, it blinks twice. <p>Blinks</p> <ul style="list-style-type: none">• The unit is in process of turning to standby mode.<ul style="list-style-type: none">– Do not disconnect the AC power supply cord (AC mains lead). Doing so may cause malfunction or damage. <hr/> <p></p> <ul style="list-style-type: none">• The mode indicator also blinks when the volume is changed.

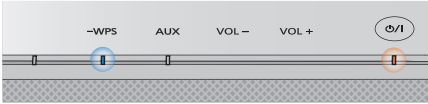

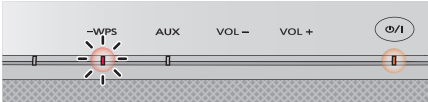
Indicator	Description
<p>Network indicator (blue/red)</p> <p>SC-ALL8</p>  <p>SC-ALL3</p> 	<p>Blinks alternately</p> <ul style="list-style-type: none">• The unit is carrying out an internal process.<ul style="list-style-type: none">– Wait for approximately 60 seconds before the blinking stops.– Do not disconnect the AC power supply cord (AC mains lead). Doing so may cause malfunction or damage.
<p>Network indicator (blue)</p> <p>SC-ALL8</p>  <p>SC-ALL3</p> 	<p>Blinks slowly</p> <ul style="list-style-type: none">• The unit is ready for network setup. (→ 12) <p>Blinks</p> <ul style="list-style-type: none">• The unit is waiting for the WPS connection. (→ 17) <p>Blinks fast</p> <ul style="list-style-type: none">• The unit is waiting for the WPS PIN code connection. (→ 17) <hr/> <p></p> <ul style="list-style-type: none">• The volume cannot be changed during the blinking.

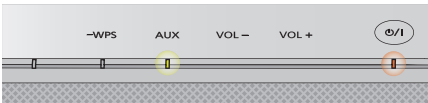

Indicator	Description
<p>Network indicator (blue)</p> <p>SC-ALL8</p>  <p>SC-ALL3</p> 	<p>Lights up</p> <ul style="list-style-type: none">• The unit is connected to the network.
<p>Network indicator (red)</p> <p>SC-ALL8</p>  <p>SC-ALL3</p> 	<p>Blinks</p> <ul style="list-style-type: none">• The unit is connecting to the network.<ul style="list-style-type: none">– When the network connection cannot be established, the blinking keeps going. Check the network connection. (→ 12)
<p>AUX indicator (green)</p> <p>SC-ALL8</p>  <p>SC-ALL3</p> 	<p>Lights up</p> <ul style="list-style-type: none">• AUX is selected as the audio source. (→ 23)



SC-ALL3

Installation

This unit can be installed either vertically or horizontally.
Install the unit with the speaker feet side down as shown below.

Vertical

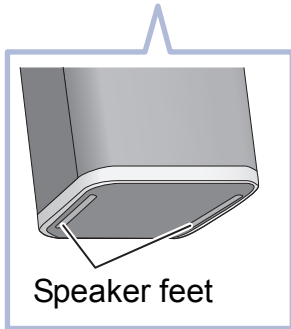

Horizontal

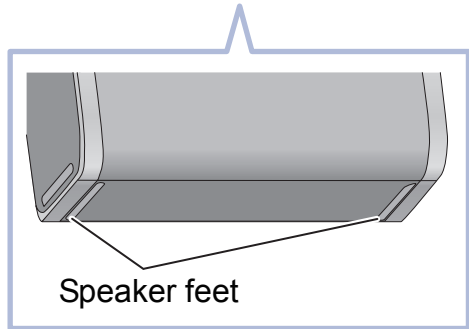

- The output sound will be automatically adjusted depending on the installation style.



Connections

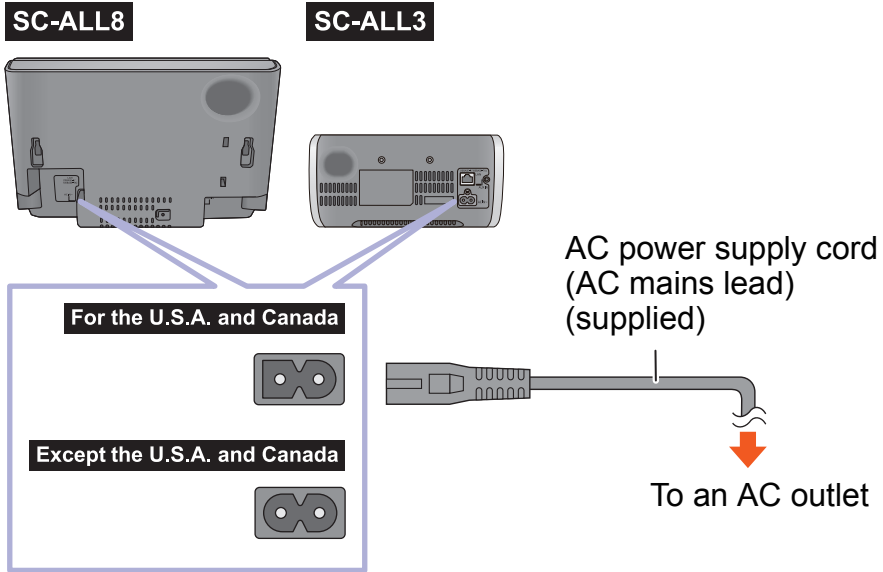

- This unit consumes a small amount of AC power (→ 33, 38) even when turned off.
- For the purpose of power conservation, the unit can be disconnected if you will not be using it for extended period of time.
- These speakers do not have magnetic shielding. Do not place them near a TV, PC or other magnetic devices.
- Do not disconnect the AC power supply cord (AC mains lead) when the unit is on. Doing so may cause malfunction or damage.

Automatic standby mode

This unit is designed to conserve its power consumption and save energy.

The unit will turn to standby mode automatically if there is no sound and it is not being used for approximately 20 minutes.

- The operation indicator (amber) blinks for approximately 1 minute before the unit turns to standby mode. Touch any switch to cancel it.



Connection of an external device

SC-ALL8

SC-ALL3

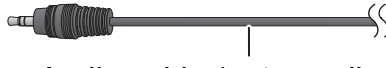
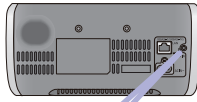
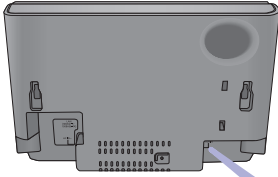

Audio cable (not supplied)
Plug type:
Ø3.5 mm (1/8") stereo



- For details, refer to the operating instructions of the device.



Network settings

You can stream music from a device on the network by using the Qualcomm® AllPlay™ smart media platform or DLNA feature. To use these features, this unit must join the same network as the device.

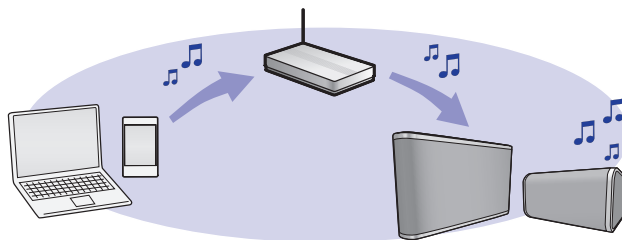

Choose a network setting method from the following.

“Using an Internet browser” (→ 13)

- You can access this unit’s network settings from the Internet browser on your smartphone or PC, etc.

“Using WPS (Wi-Fi Protected Setup™)” (→ 17)

- If your wireless router supports WPS, you can set up a connection by either pressing the WPS button, or entering the WPS PIN code.

“Using a LAN cable” (→ 18)

- You can make a stable connection to the network with a LAN cable.

Turn the network standby on (→ 16) after the network connection has been set up.



- The setting will be canceled after the set time limit. In that case, try the setting again.
- To cancel this setting in the middle, touch [⏻/⏹] to turn off the unit.



Using an Internet browser

- The following steps are based on a smartphone.
- Do not connect a LAN cable. Doing so will disable the Wi-Fi® function.

1 Turn this unit on.

2 Go to Wi-Fi® settings on the device.

- Proceed to the next step after the network indicator changes from blinking in blue and red to blinking in blue.
 - The blinking in blue starts after approximately 60 seconds. If the blinking in blue does not start, restore the factory defaults. (→ 30)
- Make sure that DHCP is enabled for the network settings on the device.



3 Select “AllPlay XXXXXX_AJ” to connect to this unit.

- “X” stands for a digit that is unique to each set.

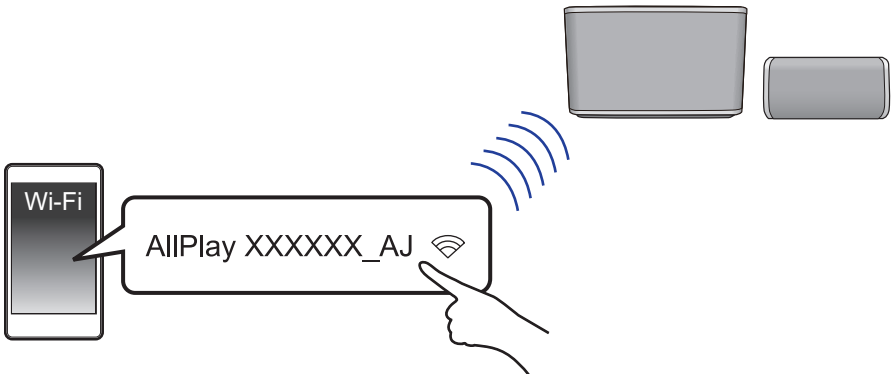



4 Start the Internet browser on the device to display the settings page.

- **iOS** : The settings page will be automatically displayed.
- **Except iOS** : Once you open the Internet browser, the settings page will be displayed
 - If the settings page is not displayed, type “http://172.19.42.1/” into the URL address field.

5 Type a device name and then select “Next”.

- The device name will be displayed as this unit’s name on the network.
- The guaranteed limit is 32 characters.
- The device name is set when “Next” is selected.
- You can also change the device name after the network connection is set up. (→ 19)

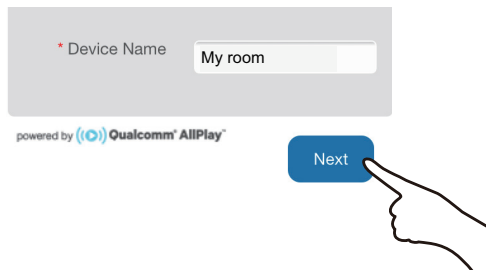



6 Select your network name (SSID) and type the password.

- Check the wireless router for the network name (SSID) and the password.
- A list of network names (SSIDs) will be appeared when you select the “Network Name” box.
- To show the characters typed in the “Password” box, select “Show Password”.
- If your network requires specific settings, select “DHCP” to disable DHCP.
 - You can use specific IP address, subnet mask, default gateway, primary DNS, etc.

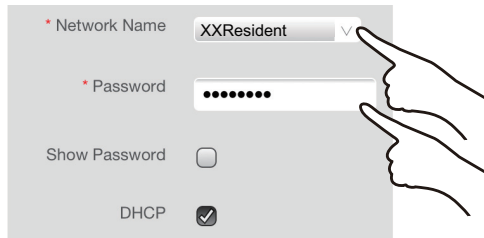

7 Select “Connect” to apply the settings.

- When the connection is established, the network indicator (blue) lights up.
- Depending on the device, the connection complete screen may not be displayed.

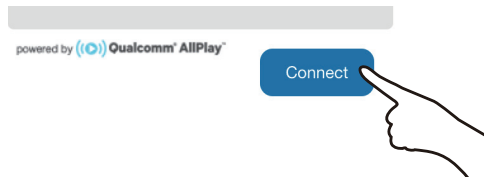

If the network indicator does not light up, check the network name (SSID) and the password, and then try the setting again.



8 Make sure the device is connected to your network.



- Enable Java and cookies in your browser settings.

■ Network standby

This unit will turn on automatically from standby mode when you select the unit as the output speakers.

Touch and hold both [-WPS] and [VOL +] until the mode indicator (amber) blinks.

The indicator blinks once: on

The indicator blinks twice: off (default)



- If this function is set to on, the network (wired LAN/Wi-Fi) remains active even in standby mode.
 - The power consumption in standby mode will increase.
- If this function is set to off, the network (wired LAN/Wi-Fi) is disabled in standby mode.
 - The network (wired LAN/Wi-Fi) will be enabled when the unit is turned on.
 - The power consumption in standby mode will be reduced.
- If the network indicator is blinking in blue and red, wait until the blinking stops.
- When the unit is turned on by this feature, the beginning part of the music may not be played back.
- Depending on the app, the conditions for activating this function may differ.
- The unit may not turn on even when selected as the output speakers. In that case, start playback.



Using WPS (Wi-Fi Protected Setup™)

- Do not connect a LAN cable. Doing so will disable the Wi-Fi function.

e.g.,

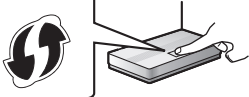

A compatible wireless router may have the WPS identifier mark.

1 Turn this unit on.

- Proceed to the next step after the network indicator changes from blinking in blue and red to blinking in blue.
 - The blinking in blue starts after approximately 60 seconds. If the blinking in blue does not start, restore the factory defaults. (→ 30)

2 Touch and hold [-WPS] on the unit.

- The network indicator (blue) blinks faster.

3 Press the WPS button on the wireless router.

- When the connection is established, the network indicator (blue) lights up.

■ Using the WPS PIN code

After step 2

1 Touch and hold [-WPS] again.

- The network indicator (blue) blinks even faster.

2 Enter the PIN code “64428147” into the wireless router.

- When the connection is established, the network indicator (blue) lights up.



- When canceling the setting in the middle by touching [⏻/|], the unit takes a while to turn off.
 - The mode indicator (amber) blinks until the unit is turned off.
- Once the unit enters WPS PIN code mode, you cannot set up using the WPS button. To use the WPS button, turn off and then on the unit, and redo the network settings.
- For details, refer to the operating instructions of the wireless router.



Using a LAN cable

- 1 Disconnect the AC power supply cord (AC mains lead).
- 2 Connect this unit to a broadband router, etc. using a LAN cable.

e.g.,

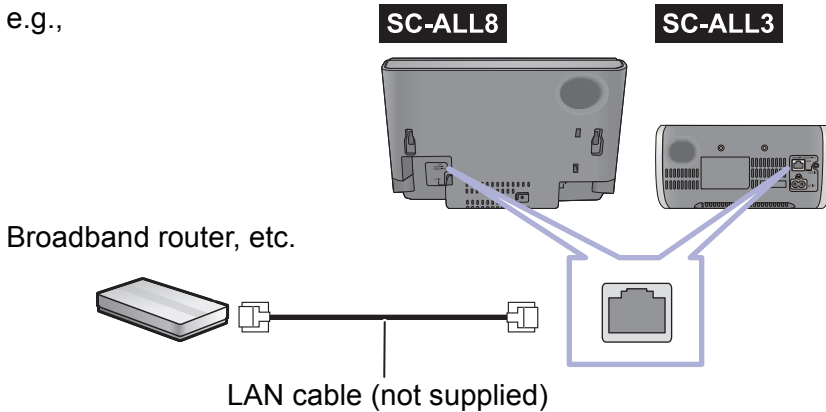

- 3 Connect the AC power supply cord (AC mains lead) to this unit, and turn the unit on.

- When the connection is established, the network indicator (blue) lights up.



- Use category 5 or above straight LAN cables (STP) when connecting to peripheral devices.
- The LAN cable must be connected or disconnected while the AC power supply cord (AC mains lead) is disconnected.
- Inserting any cable other than a LAN cable in the LAN port can damage the unit.
- If the LAN cable is disconnected, the network-related settings (→ 19) will be initialized. In that case, make the settings again.
- When a LAN cable is connected, the Wi-Fi function will be disabled.
 - Power consumption will be reduced when the unit is turned on or is in standby mode.



To make network-related settings

You can change this unit's name on the network, and use specific IP address, subnet mask, default gateway, primary DNS, etc.

Preparation

- Complete the network settings.

- 1 Check this unit's IP address (→ 26), and note it down.**
- 2 Connect your device to the same network as this unit.**
- 3 Start an Internet browser on your device and then type this unit's IP address into the address field to display the settings page.**

- It may take a few minutes until the settings page is displayed depending on the environment. In that case, reload the browser.
- If the unit is connected with Wi-Fi, only a device name can be changed. Close the settings page after changing the device name.
 - To change the device name, select “Change”, and type a new device name, and then select “Apply”.

- 4 Type a device name and then select “Next”.**

- Refer to the step 5 of “Using an Internet browser” (→ 14) for details on a device name.

- 5 Select and input the details.**

- If your network requires specific settings, select “DHCP” to disable DHCP.
 - You can use specific IP address, subnet mask, default gateway, primary DNS, etc.

- 6 Select “Connect” to apply the settings.**

- When the connection is established, the network indicator (blue) lights up.



Enjoying music

You can enjoy music on your home network, online music services, and an external device (AUX input).

Home network

To stream music from the device on the network to this unit as AllPlay/DLNA speakers, you need to download the app “Panasonic Music Streaming” (free of charge), etc.

- **iOS** : App Store
- **Android** : Google Play™



Preparation

- Connect the following devices to the same network as this unit.
 - Device with “Panasonic Music Streaming”, etc. installed
 - Device containing music

The following steps are based on “Panasonic Music Streaming”.

1 Turn this unit on.

- The network indicator (blue) lights up.
 - If the network indicator is blinking in blue and red, wait until the blinking stops.

2 Start the app “Panasonic Music Streaming”.

3 Select a music source.

- To add music source, select “” and then select the device containing music.
 - The added music source is numbered in order from 1.

4 Select a song to playback.

- To stop the playback, select stop or pause.



5 **iOS** : From “**(🔊)**”, select this unit as the output speakers.

e.g.,



Android : From “**Select Speaker**”, select this unit as the output speakers.

- If you have multiple AllPlay speakers, you can enjoy synchronized sound from them. Select “**GROUP**” and then select the speakers to group.
 - You can also play different songs on other AllPlay speakers at the same time.
 - The number of AllPlay speakers that can perform playback at the same time differs depending on the situation of use.



- This unit will be displayed as “Panasonic ALL8” (**SC-ALL8**) / “Panasonic ALL3” (**SC-ALL3**) if the device name is not set.
 - DLNA speakers (🔊) may not display the device name you have set. In that case, turn off “Network standby” (→ 16), and then turn this unit off and on.
- When playing back music from the DLNA server (PC with Windows 7 or later installed, smartphone, Network Attached Storage (NAS) device, etc.), add the contents and folder to the libraries of the Windows Media® Player, the smartphone, or the NAS device, etc.
 - Playlist of Windows Media® Player can play back only the contents that are stored in the libraries.
- When this unit is selected as DLNA speakers (🔊):
 - The volume control on the unit may not apply to the app.
 - Playback control using a progress bar on playback screen may not work.
- About supported format, refer to “Audio support format” (→ 36, 40).
 - File formats that are not supported by your DLNA server cannot be played.
- Depending on the contents and the connected equipment, playback may not be possible.
- More apps are available. For details, visit www.panasonic.com/global/consumer/homeav/allseries/service
- For details on the app “Panasonic Music Streaming”, visit <http://panasonic.jp/support/global/cs/>
(These sites are in English only.)



Online music services

This unit is compatible with several music services.

Visit the following website for the compatibility information.

www.panasonic.com/global/consumer/homeav/allseries/service

Preparation

- Make sure that the network is connected to the Internet.
- Connect a device with a compatible app installed to the same network as this unit.

1 Turn this unit on.

- The network indicator (blue) lights up.
 - If the network indicator is blinking in blue and red, wait until the blinking stops.

2 Start the app, and select a song to playback.

■ Using Spotify

- **For Canada** Spotify is not available.
- You will need Spotify Premium. For details, visit the following website.
www.spotify.com/connect/

After step 2

3 Select the square image of the song's cover art in the bottom left of the playback screen.

4 From “”, select this unit as the output speakers.

- To enjoy synchronized sound from the multiple AllPlay speakers, you need to group the speakers using the app “Panasonic Music Streaming”. (→ 20)



■ Using online music services other than Spotify

After step 2

3 From “((🔊))”, select this unit as the output speakers.

- Depending on the service, you might need to open full screen player to display “((🔊))”.
- If you have multiple AllPlay speakers, you can enjoy synchronized sound from them. Select “Group” and then select the speakers to group.



- This unit will be displayed as “Panasonic ALL8” (**SC-ALL8**) / “Panasonic ALL3” (**SC-ALL3**) if the device name is not set.
- Registration/subscription is required.
- Fees may apply.
- Services, icons, and specifications subject to change.
- For details, visit the individual music service’s website.

AUX input

You can also listen to music from an external music player through this unit.

Preparation

- Connect an external device. (→ 11)

1 Touch [AUX].

- The AUX indicator (green) lights up.

2 Start playback on the connected device.



- To change the audio source from AUX to the network, touch [AUX] again.
- When the unit is selected as the AllPlay/DLNA speakers, the audio source will change to the network.
- AUX cannot be selected as the audio source when the unit is waiting for the WPS or WPS PIN code connection.



Firmware updates

Occasionally, Panasonic may release updated firmware for this unit that may add or improve the way a feature operates. These updates are available free of charge.

Preparation

- Connect this unit to the network. (→ 12)
 - Make sure that the network is connected to the Internet.

1 Touch and hold [-WPS]. When the operation indicator (amber) starts blinking and while you are still touching and holding [-WPS], touch [AUX].

- The mode indicator (amber) starts blinking.
 - Release your fingers from the switches after the blinking starts.
 - If the mode indicator goes off after approximately 1 minute, the latest firmware is already installed. The firmware update will be canceled.
 - No other operations can be performed.
- The update will require approximately 4 minutes.
 - Do not disconnect the AC power supply cord (AC mains lead). Doing so may cause malfunction or damage.

2 After the mode indicator (amber) stops blinking and lights up, disconnect the AC power supply cord (AC mains lead).

3 After 3 minutes, reconnect the AC power supply cord (AC mains lead), and turn the unit on.

- The network indicator will blink in blue and red alternately for up to a minute. The update is complete when it stops blinking.



- If the mode indicator (amber) keeps blinking for more than 5 minutes, an error may have occurred. Refer to firmware update troubleshooting. (→ 31)



Others

Operation sound setting

You can turn the beep sound on/off.

Touch and hold both [-WPS] and [VOL -] until the mode indicator (amber) blinks.

The indicator blinks once: on (default)

The indicator blinks twice: off



- If the network indicator is blinking in blue and red, wait until the blinking stops.

Wi-Fi signal strength

To check the Wi-Fi signal strength where the unit is located.
If you are playing music on the network, stop the playback.

Touch and hold both [-WPS] and [AUX].

- The mode indicator (amber) blinks once and then blinks again to show the Wi-Fi signal strength.
 - If the mode indicator (amber) does not blink again, the unit is not connected to the network.

Number of blinks	Wi-Fi signal strength
1	Weak
2	
3	Strong



- If the network indicator is blinking in blue and red, wait until the blinking stops.
- If the Wi-Fi signal strength cannot be checked, deselect the unit from AllPlay/ DLNA speakers, and try again.



IP/MAC address

To check the unit's IP address and the MAC address.

Preparation

- Download the app “Panasonic Music Streaming”. (→ 20)

1 Start the app “Panasonic Music Streaming”.

2 iOS : Select “(▶)”.

Android : Select “Select Speaker”.

3 Select “GROUP”.

e.g.,

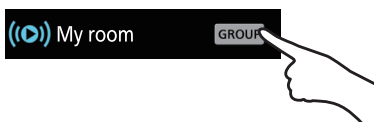

4 Touch and hold “Group” in the title bar at the top.

e.g.,

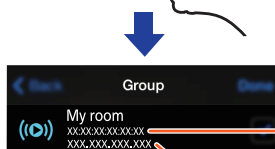
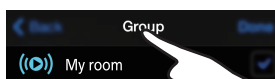

MAC address
IP address



- This unit will be displayed as “Panasonic ALL8” (**SC-ALL8**) / “Panasonic ALL3” (**SC-ALL3**) if the device name is not set.
- If the network indicator is blinking in blue and red, wait until the blinking stops.



SC-ALL8

Attaching to a wall (optional)

Consult a qualified building contractor when attaching the unit to a wall.

WARNING

- To prevent injury, this apparatus must be securely attached to the wall in accordance with the installation instructions.
- Keep the safety holder, the screws, and the wall mount brackets out of reach of children to prevent swallowing.

Preparation

- Turn the unit off and disconnect the AC power supply cord (AC mains lead) from the AC outlet.
- Make sure the location to place the unit has a stable Wi-Fi connection. (→ 25)

1 Fix the safety holder onto the unit.

- Screw tightening torque: 50 N•cm (0.4 lbf•ft) to 70 N•cm (0.5 lbf•ft).

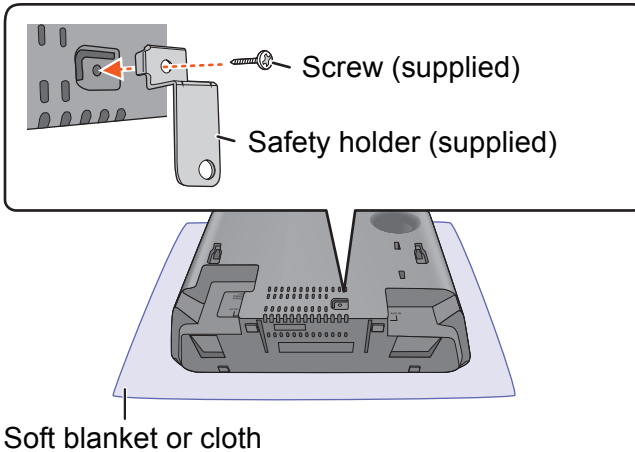



2 Attach the fall prevention cord to the unit.

- Use a cord that is capable of supporting over 50 kg (110 lbs) with a diameter of about 1.5 mm ($1/16''$).

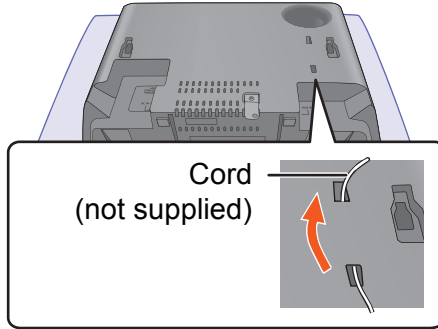

3 Attach the wall mount brackets to the wall, and then hook the unit securely onto them.

- Make sure that the wall and the screws are capable of supporting at least 50 kg (110 lbs).
- Use a level to ensure both wall mount brackets are level.
- Connect the AC power supply cord (AC mains lead) to the unit before hanging the unit onto the wall. (→ 10)

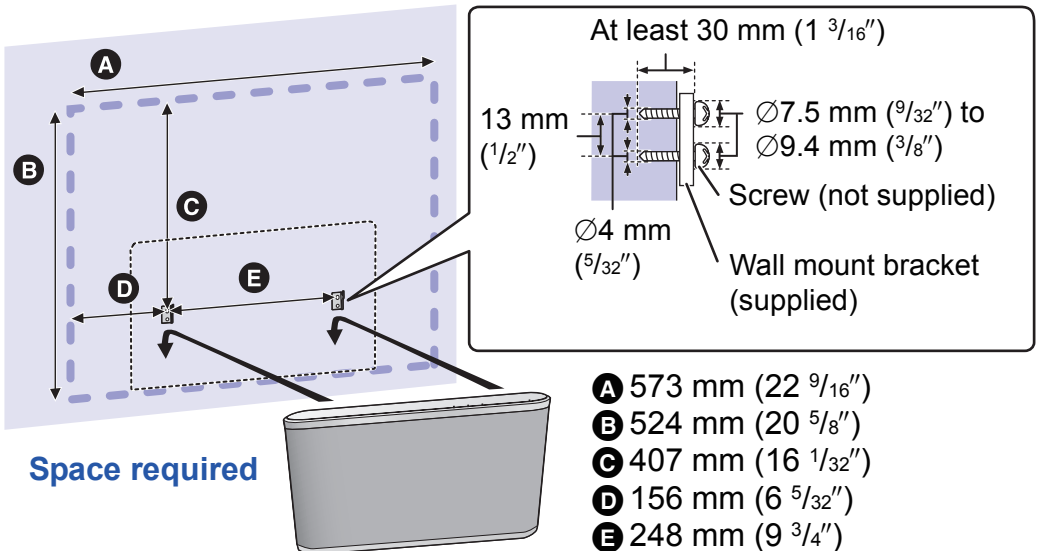



4 Drive a screw to secure the safety holder onto the wall.

- Refer to step 3 for requirements before screwing.

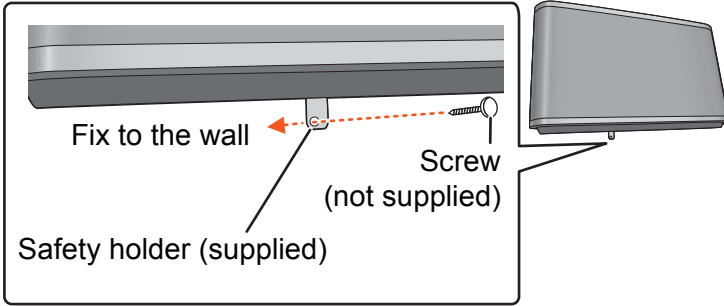

5 Attach the fall prevention cord to the wall.

- Make sure that the slack of the cord is minimal.

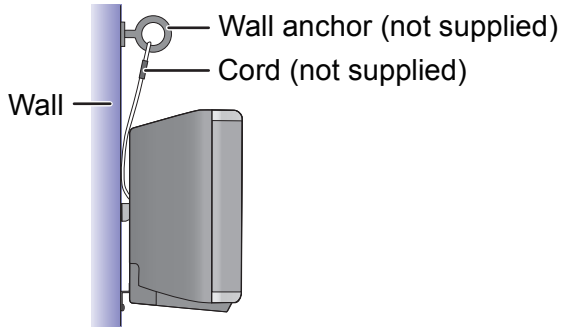



Troubleshooting

Before requesting service, make the following checks.
If the problem remains unresolved, consult your dealer for instructions.

For the U.S.A. and Canada

Refer to the limited warranty on the “Owner’s Manual <Setup>”.

Do you have the latest firmware installed?

- Panasonic is constantly improving the unit’s firmware to ensure that our customers are enjoying the latest technology. (→ 24)

General

To return all settings to the factory defaults

- ① Turn this unit on.
 - If the network indicator is blinking in blue and red, proceed to the next step after the blinking stops.
- ② Touch and hold [⏻/I].
 - The operation indicator (amber) starts to blink.
- ③ While continuing to hold [⏻/I], touch [-WPS].
 - The mode indicator (amber) blinks 4 times.

Humming heard during playback.

- There are cords of other appliances or fluorescent light near the unit’s AC power supply cord (AC mains lead). Turn the appliances off or keep them away from the AC power supply cord (AC mains lead).

The sound is distorted when using the AUX IN jack.

- High level of input signal distorts the sound. Turn down the volume of the connected device to reduce the input signal.

The network indicator does not stop blinking in blue and red.

- The unit needs to be repaired. Consult your dealer.



Firmware updates

The mode indicator (amber) keeps blinking twice.

- This unit is not connected to the network. Touch any switch, and then check the network connection. (→ 12)
-

The mode indicator (amber) keeps blinking three times.

- The update has been failed. Touch any switch, and then try again.
-

The mode indicator (amber) keeps blinking fast.

- An error has occurred. Disconnect the AC power supply cord (AC mains lead) and reconnect it. Turn the unit on and try again.

Network

The network indicator (red) keeps blinking.

- This unit is not connected to the network. Check the network connection. (→ 12)
-

Cannot connect to the network.

- This unit's Wi-Fi security supports WPA2™ only. Use a wireless router that provides a WPA2™ connection. For details on security supported by the router, refer to the operating instructions of the router.
 - If the network is set to be invisible, make the network visible while you set up the network for this unit or make a wired LAN connection. (→ 18)
 - Make sure that the multicast function on the wireless router is enabled.
 - Depending on the routers, WPS button may not work. Try other methods. (→ 12)
-

The device name is not changed.

- Turn off "Network standby" (→ 16), and turn this unit off and on.



Cannot select this unit as the output speakers.

- Make sure that the devices are connected to the same network as this unit.
 - Reconnect the devices to the network.
 - Turn off and then on the wireless router.
 - Turn off “Network standby” (→ 16), and turn this unit off and on.
-

Playback does not start.**The sound is interrupted.**

- If using the 2.4 GHz band on the wireless router, simultaneous use with other 2.4 GHz devices, such as microwaves, cordless telephones, etc., may result in connection interruptions. Increase the distance between this unit and these devices.
 - If your wireless router supports 5 GHz band, try using the 5 GHz band.
To change to the 5 GHz band, restore the factory defaults (→ 30), and redo the network settings using an Internet browser (→ 13). On the step 6, make sure to select your network name (SSID) for the 5 GHz band.
- Do not place this unit inside a metal cabinet, for it might block the Wi-Fi signal.
- Place this unit closer to the wireless router.
- If several wireless devices are simultaneously using the same network as this unit, try turning off the other devices or reducing their network usage.
- Reconnect the devices to the network.
- Turn off and then on the wireless router.
- Try a wired LAN connection. (→ 18)



Specifications

SC-ALL8

■ GENERAL

Power supply

For the U.S.A. and Canada

AC 120 V, 60 Hz

For the United Kingdom and Ireland

For Continental Europe

For Australia and New Zealand

AC 220 V to 240 V, 50 Hz

Power consumption

22 W

Power consumption in standby mode

For the U.S.A. and Canada

Approx. 0.1 W

For the United Kingdom and Ireland

For Continental Europe

For Australia and New Zealand

Approx. 0.15 W

(When “Network standby” is on)

Approx. 3.0 W



Dimensions (W×H×D)

373 mm×224 mm×138 mm
(14 11/16"×8 13/16"×5 7/16")

Mass (Weight)

Approx. 4.2 kg (9.26 lbs)

Operating temperature range

0 °C to +40 °C (+32 °F to +104 °F)

Operating humidity range

35 % to 80 % RH (no condensation)

■ AMPLIFIER SECTION

RMS output power

Front Ch (both ch driven)

20 W per channel (8 Ω), 1 kHz, 10 % THD

Subwoofer

40 W (4 Ω), 100 Hz, 10 % THD

Total power

80 W

For the U.S.A. and Canada

FTC output power

Front Ch (both ch driven)

12 W per channel (8 Ω), 120 Hz to 20 kHz, 1.0 % THD

Subwoofer

36 W (4 Ω), 20 Hz to 120 Hz, 1.0 % THD

Total power

60 W



■ FRONT SPEAKER (L/R)

Speaker unit(s)

1. Woofer
2. Tweeter

8 cm (3 1/8") cone type×2
2.5 cm (1") semi-dome type×2

Impedance

8 Ω

■ SUBWOOFER

Speaker unit(s)

1. Subwoofer

12 cm (4 3/4") cone type×1

Impedance

4 Ω

■ Wi-Fi SECTION

WLAN Standard

IEEE802.11a/b/g/n

Frequency range

2.4 GHz band / 5 GHz band

Security

WPA2™

WPS version

Version 2.0

■ TERMINALS SECTION

AUX Terminal

Stereo, Ø3.5 mm (1/8") jack

LAN port

10 Base-T/100 Base-TX



■ Audio support format (AllPlay)

MP3/AAC

Sampling frequency	32/44.1/48 kHz
Audio word size	16 bit
Channel count	2 ch
Bit-rate	8-320 kbps

FLAC/ALAC

Sampling frequency	32/44.1/48/88.2/96/176.4/192 kHz
Audio word size	16 bit, 24 bit
Channel count	2 ch

WAV

Sampling frequency	32/44.1/48/88.2/96/176.4/192 kHz
Audio word size	16 bit, 24 bit
Channel count	2 ch

■ Audio support format (DLNA)

MP3

Sampling frequency	32/44.1/48 kHz
Audio word size	16 bit
Channel count	2 ch
Bit-rate	8-320 kbps

FLAC

Sampling frequency	32/44.1/48/88.2/96/176.4/192 kHz
Audio word size	16 bit, 24 bit
Channel count	2 ch

WAV

Sampling frequency	32/44.1/48/88.2/96/176.4/192 kHz
Audio word size	16 bit, 24 bit
Channel count	2 ch



-
- Specifications are subject to change without notice.
 - Mass and dimensions are approximate.
 - Total harmonic distortion is measured by a digital spectrum analyzer.
 - Uncompressed FLAC files may not operate correctly.
 - High sampling audio format (above 88.2 kHz) play with down-sampling as below.
 - 88.2 kHz/176.4 kHz → 44.1 kHz
 - 96 kHz/192 kHz → 48 kHz



SC-ALL3

■ GENERAL

Power supply

For the U.S.A. and Canada

AC 120 V, 60 Hz

For the United Kingdom and Ireland

For Continental Europe

For Australia and New Zealand

AC 220 V to 240 V, 50 Hz

Power consumption

14 W

Power consumption in standby mode

Approx. 0.2 W

(When “Network standby” is on)

Approx. 3.0 W

Dimensions (W×H×D)

Horizontal placing

248 mm×131 mm×155 mm
(9 3/4"×5 5/32"×6 3/32")

Vertical placing

131 mm×248 mm×165 mm
(5 5/32"×9 3/4"×6 1/2")

Mass (Weight)

Approx. 2.5 kg (5.51 lbs)

Operating temperature range

0 °C to +40 °C (+32 °F to +104 °F)

Operating humidity range

35 % to 80 % RH (no condensation)



■ AMPLIFIER SECTION

RMS output power

Front Ch (both ch driven)

20 W per channel (8 Ω), 1 kHz, 10 % THD

Total power

40 W

For the U.S.A. and Canada

FTC output power

Front Ch (both ch driven)

13 W per channel (8 Ω), 80 Hz to 20 kHz, 1.0 % THD

Total power

26 W

■ FRONT SPEAKER (L/R)

Speaker unit(s)

1. Woofer

8 cm (3 1/8") cone type \times 2

2. Tweeter

2.5 cm (1") semi-dome type \times 2

Impedance

8 Ω

■ Wi-Fi SECTION

WLAN Standard

IEEE802.11a/b/g/n

Frequency range

2.4 GHz band / 5 GHz band

Security

WPA2™

WPS version

Version 2.0

■ TERMINALS SECTION

AUX Terminal

Stereo, \varnothing 3.5 mm (1/8") jack

LAN port

10 Base-T/100 Base-TX



■ Audio support format (AllPlay)

MP3/AAC

Sampling frequency	32/44.1/48 kHz
Audio word size	16 bit
Channel count	2 ch
Bit-rate	8-320 kbps

FLAC/ALAC

Sampling frequency	32/44.1/48/88.2/96/176.4/192 kHz
Audio word size	16 bit, 24 bit
Channel count	2 ch

WAV

Sampling frequency	32/44.1/48/88.2/96/176.4/192 kHz
Audio word size	16 bit, 24 bit
Channel count	2 ch

■ Audio support format (DLNA)

MP3

Sampling frequency	32/44.1/48 kHz
Audio word size	16 bit
Channel count	2 ch
Bit-rate	8-320 kbps

FLAC

Sampling frequency	32/44.1/48/88.2/96/176.4/192 kHz
Audio word size	16 bit, 24 bit
Channel count	2 ch

WAV

Sampling frequency	32/44.1/48/88.2/96/176.4/192 kHz
Audio word size	16 bit, 24 bit
Channel count	2 ch



-
- Specifications are subject to change without notice.
 - Mass and dimensions are approximate.
 - Total harmonic distortion is measured by a digital spectrum analyzer.
 - Uncompressed FLAC files may not operate correctly.
 - High sampling audio format (above 88.2 kHz) play with down-sampling as below.
 - 88.2 kHz/176.4 kHz → 44.1 kHz
 - 96 kHz/192 kHz → 48 kHz



Qualcomm® AllPlay™ smart media platform is a product of Qualcomm Connected Experiences, Inc.
Qualcomm is a trademark of Qualcomm Incorporated, registered in the United States, and other countries and used with permission.
AllPlay and the AllPlay icon are trademarks of Qualcomm Connected Experiences, Inc., and used with permission.

This product incorporates Spotify software which is subject to 3rd party licenses found here: www.spotify.com/connect/third-party-licenses

Google Play and Android are trademarks of Google Inc.

DLNA, the DLNA Logo and DLNA CERTIFIED are trademarks, service marks, or certification marks of the Digital Living Network Alliance.

App Store is a service mark of Apple Inc.



The Wi-Fi CERTIFIED Logo is a certification mark of the Wi-Fi Alliance.
The Wi-Fi Protected Setup Mark is a mark of the Wi-Fi Alliance.
“Wi-Fi”, “Wi-Fi Protected Setup” and “WPA2” are marks or registered marks of the Wi-Fi Alliance.

Windows is a trademark or a registered trademark of Microsoft Corporation in the United States and other countries.

MPEG Layer-3 audio coding technology licensed from Fraunhofer IIS and Thomson.



For the United Kingdom and Ireland customers

Sales and Support Information

Customer Communications Centre

- For customers within the UK: 0844 844 3899
- For customers within Ireland: 01 289 8333
- Monday–Friday 9:00 am – 5:00 pm
(Excluding public holidays).
- For further support on your product, please visit our website:
www.panasonic.co.uk

Direct Sales at Panasonic UK

- Order accessory and consumable items for your product with ease and confidence by phoning our Customer Communications Centre Monday–Friday 9:00 am – 5:00 pm
(Excluding public holidays).
- Or go on line through our Internet Accessory ordering application at
www.pas-europe.com.
- Most major credit and debit cards accepted.
- All enquiries transactions and distribution facilities are provided directly by Panasonic UK.
- It couldn't be simpler!
- Also available through our Internet is direct shopping for a wide range of finished products. Take a browse on our website for further details.

For Canada

This device is restricted to indoor use due to its operation in the 5.15 to 5.25 GHz frequency range.

High-power radars are allocated as primary users (i.e. priority users) of the bands 5.25 to 5.35 GHz and 5.65 to 5.85 GHz and that these radars could cause interference and/or damage to LE-LAN devices.

The maximum antenna gain permitted for the device is 4.3 dBi, to comply with the EIRP limit in 5250-5350 MHz, 5470-5725 MHz, and 5725-5825 MHz specified for point-to-point operation.

Manufactured by: Panasonic Corporation
Kadoma, Osaka, Japan
Importer for Europe: Panasonic Marketing Europe GmbH
Panasonic Testing Centre
Winsbergring 15, 22525 Hamburg, Germany

For the U.S.A.

**Panasonic Corporation of
North America**

Two Riverfront Plaza, Newark, NJ
07102-5490

<http://www.panasonic.com>

For Canada

Panasonic Canada Inc.

5770 Ambler Drive,
Mississauga, Ontario,
L4W 2T3

www.panasonic.com

For the United Kingdom and Ireland

For Continental Europe

For Australia and New Zealand

Panasonic Corporation

Web Site: <http://panasonic.net>