

Use & Care Guide
Manual de Uso y Cuidado
English / Español

Model/Modèle: 790.4845*

Kenmore Elite[®]

Electric Built-In Oven

Horno de pared doble

* = color number, número de color

P/N 139900109 Rev. A

Sears Brands Management Corporation
Hoffman Estates, IL 60179 U.S.A.
www.kenmore.com
www.sears.com

Sears Canada Inc.
Toronto (Ontario) Canada M5B 2C3
www.sears.ca



Table of Contents

KENMORE ELITE LIMITED WARRANTY	2	Setting the Sabbath Feature	23
Before Setting Oven Controls	7	Self Clean	25
Removing, Replacing, and Arranging Oven Racks	7	Care and Cleaning	27
Glide Racks	8	Cleaning Various Parts of Your Oven	27
Oven Controls	9	Caring for Your Porcelain Enameled Glide Racks	28
Setting Bake	13	Replacing the Oven Light	29
Setting Broil	15	General Cleaning	29
Setting Convection Bake	16	Removing and Replacing the Oven Door	30
Meat Probe	20	Before You Call	31
Adjusting Oven Temperatures	22	Oven Baking	31
		Solutions to Common Problems	32

KENMORE ELITE LIMITED WARRANTY

FOR ONE YEAR from the date of sale this appliance is warranted against defects in material or workmanship when it is correctly installed, operated and maintained according to all supplied instructions.

WITH PROOF OF SALE, a defective appliance will receive free repair or replacement at option of seller.

To arrange for warranty service, call 1-800-4-MY-HOME® (1-800-469-4663).

This warranty applies for only 90 DAYS from the sale date in the United States, and is void in Canada, if this appliance is ever used for other than private household purposes.

This warranty covers **ONLY** defects in material and workmanship, and will **NOT** pay for:

1. Cracks in a ceramic glass cooktop that are not a result of thermal shock.
2. Stains and scratches on a ceramic glass cooktop resulting from accident or improper operation or maintenance.
3. Discoloration of cooktop surfaces resulting from normal use.
4. Expendable items that can wear out from normal use, including but not limited to filters, belts, bags or screw-in base light bulbs.
5. A service technician to clean or maintain this appliance, or to instruct the user in correct appliance installation, operation and maintenance.
6. Service calls to correct appliance installation not performed by Sears authorized service agents, or to repair problems with house fuses, circuit breakers, house wiring, and plumbing or gas supply systems resulting from such installation.
7. Damage to or failure of this appliance resulting from installation not performed by Sears authorized service agents, including installation that was not in accord with electrical, gas or plumbing codes.
8. Damage to or failure of this appliance, including discoloration or surface rust, if it is not correctly operated and maintained according to all supplied instructions.
9. Damage to or failure of this appliance, including discoloration or surface rust, resulting from accident, alteration, abuse, misuse or use for other than its intended purpose.
10. Damage to or failure of this appliance, including discoloration or surface rust, caused by the use of detergents, cleaners, chemicals or utensils other than those recommended in all instructions supplied with the product.
11. Damage to or failure of parts or systems resulting from unauthorized modifications made to this appliance.
12. Service to an appliance if the model and serial plate is missing, altered, or cannot easily be determined to have the appropriate certification logo.

Disclaimer of implied warranties; limitation of remedies

Customer's sole and exclusive remedy under this limited warranty shall be product repair or replacement as provided herein. Implied warranties, including warranties of merchantability or fitness for a particular purpose, are limited to one year or the shortest period allowed by law. Seller shall not be liable for incidental or consequential damages. Some states and provinces do not allow the exclusion or limitation of incidental or consequential damages, or limitation on the duration of implied warranties of merchantability or fitness, so these exclusions or limitations may not apply to you.

This warranty applies only while this appliance is used in the United States or Canada*.

This warranty gives you specific legal rights, and you may also have other rights which vary from state to state.

* In-home repair service is not available in all Canadian geographical areas, nor will this warranty cover user or servicer travel and transportation expenses if this product is located in a remote area (as defined by Sears Canada Inc.) where an authorized servicer is not available.

Sears Brands Management Corporation, Hoffman Estates, IL 60179
Sears Canada Inc., Toronto, Ontario, Canada M5B 2C3



IMPORTANT SAFETY INSTRUCTIONS

Read all instructions before using this appliance.

Read all instructions before using this appliance.

This manual contains important safety symbols and instructions. Pay attention to these symbols and follow all instructions given.

Do not attempt to install or operate your appliance until you have read the safety precautions in this manual. Safety items throughout this manual are labeled with a WARNING or CAUTION statement based on the hazard type.

DEFINITIONS

⚠ This is the safety alert symbol. It is used to alert you to potential personal injury hazards. Obey all safety messages that follow this symbol to avoid possible injury or death.

⚠ WARNING - Indicates a potentially hazardous situation which, if not avoided, may result in death or serious injury.

⚠ CAUTION - Indicates a potentially hazardous situation which, if not avoided, may result in minor or moderate injury.

Important: Indicates installation, operation, maintenance, or valuable information that is not hazard related.

⚠ WARNING Storage In or On Appliance—Flammable materials should not be stored in an oven or near surface units. This includes paper, plastic, and cloth items, such as cookbooks, plastic ware, and towels, as well as flammable liquids. Do not store explosives, such as aerosol cans, on or near the oven.

⚠ CAUTION Use dry potholders. Moist or damp potholders on hot surfaces may result in burns from steam. Do not let potholders touch hot cooking areas. Do not use towels or other bulky cloths.

⚠ WARNING Tip Over Hazard

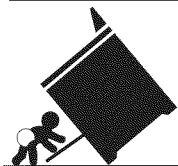

- A child or adult can tip the oven and be killed.
- Install the anti-tip device to oven and/or structure per installation instructions.

- Ensure the anti-tip device is re-engaged when the oven is moved.
- Do not operate the oven without the anti-tip device in place and engaged.
- Failure to follow these instructions can result in death or serious burns to children and adults.

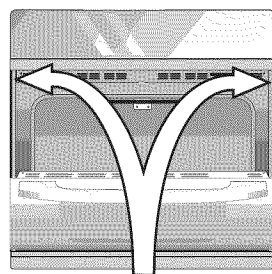

Anti-tip mounting holes

Refer to the installation instructions supplied with your appliance for proper installation.

Check for proper installation with a visual check that the anti-tip screws are present.

Test the installation with light downward pressure on the open oven door. The oven should not tip forward.

⚠ WARNING Do Not Leave Children Alone - Children should not be left alone or unattended in the area where appliance is in use. They should never be allowed to sit or stand on any part of the appliance, including the storage drawer, lower broiler drawer, warmer drawer, or lower double oven.

⚠ CAUTION Do not store items of interest to children in the cabinets above a range or on the backguard of the range. Children climbing on the range to reach items could be seriously injured.

IMPORTANT SAFETY INSTRUCTIONS

Read all instructions before using this appliance.

⚠ WARNING Stepping, leaning, or sitting on the door or drawers of an oven can result in serious injuries and also cause damage to the appliance. Do not allow children to climb or play around the oven. The weight of a child on an open oven door may cause the oven to tip, resulting in serious burns or other injury.

⚠ WARNING Never cover any slots, holes, or passages in the oven bottom or cover an entire oven rack with materials, such as aluminum foil. Aluminum foil linings may trap heat, causing a fire hazard.

⚠ CAUTION Wear proper apparel. Loose-fitting or hanging garments should never be worn while using this appliance. Do not let clothing or other flammable materials come into contact with hot surfaces.

⚠ CAUTION Do not heat unopened food containers. Build-up of pressure may cause container to burst and result in injury.

⚠ CAUTION When heating fat or grease, watch it closely. Grease may catch fire if it becomes too hot.

⚠ CAUTION Do not use water or flour on grease fires. Smother fire or flame or use dry chemical or foam-type extinguisher. Cover the fire with a pan lid or use baking soda.

Important: Important Safety Notice - The California Safe Drinking Water and Toxic Enforcement Act requires the governor of California to publish a list of substances known to cause cancer, birth defects, or other reproductive harms, and it requires businesses to warn customers of potential exposures to such substances.

⚠ CAUTION Read and follow the below instructions and precautions for unpacking, installing, and servicing your appliance:

- Remove all tape and packaging before using the oven. Destroy the carton and plastic bags after unpacking the oven. Never allow children to play with packaging material.
- Proper Installation—Be sure your appliance is properly installed and grounded by a qualified technician in accordance with the National Electrical Code ANSI/NFPA No. 70 latest edition and local electrical code requirements. In Canada, install in accordance with CSA Standard C22.1, Canadian Electrical code, Part 1, and local electrical code requirements. Install only per installation instructions provided in the literature package for this oven.
- User Servicing—Do not repair or replace any part of the appliance unless specifically recommended in the manuals. All other servicing should be done only by a qualified technician. This reduces the risk of personal injury and damage to the oven.
- Ask your dealer to recommend a qualified technician and an authorized repair service. Know how to disconnect the power to the oven at the circuit breaker or fuse box in case of an emergency.
- Do not attempt to operate the oven during a power failure. If the power fails, always turn off the oven. If the oven is not turned off and the power resumes, the oven will begin to operate again. Once the power resumes, reset the clock and oven function.
- Remove the oven door from any unused oven if it is to be stored or discarded.

Save these instructions for future reference.

IMPORTANT SAFETY INSTRUCTIONS

Read all instructions before using this appliance.

- Never modify or alter the construction of an oven by removing the leveling legs, panels, wire covers, anti-tip brackets/screws, or any other part of the oven.
- Cold temperatures can damage the electronic control. When using this appliance for the first time, or when the appliance has not been used for an extended period of time, be sure the appliance has been in temperatures above 32°F (0°C) for at least 3 hours before turning on the power to the appliance.
- Be sure to have an appropriate foam-type fire extinguisher available, visible, and easily located near the appliance.

IMPORTANT INSTRUCTIONS FOR USING YOUR OVEN

- Never use your appliance for warming or heating the room.
- Use care when opening oven door, lower oven door, or warmer drawer (some models). Stand to the side of the oven when opening the door of a hot oven. Let hot air or steam escape before you remove or replace food in the oven.
- Keep oven vent ducts unobstructed. Touching surfaces in this area when the oven is on may cause severe burns. Do not place plastic or heat-sensitive items on or near the oven vent. These items can melt or ignite.
- Placement of Oven Racks - Always place oven racks in desired location while oven is cool. If rack must be moved while oven is hot, do not let potholder contact hot heating element in oven. Use potholders and grasp the rack with both hands to reposition. Remove all bakeware and utensils before moving the rack.
- Do not use a broiler pan without its insert. Broiler pans and inserts allow dripping fat to drain away from the high heat of the broiler. Do not cover the broiler insert with

aluminum foil; exposed fat and grease could ignite.

- Protective Liners - Do not use aluminum foil to line surface unit drip bowls or oven bottoms, except as suggested in the manual. Improper installation of these liners may result in a risk of electric shock, or fire.
- Do not cook food on the oven bottom. Always cook in proper bakeware and always use the oven racks.

IMPORTANT INSTRUCTIONS FOR CLEANING YOUR OVEN

⚠ CAUTION Before manually cleaning any part of the oven, be sure all controls are turned off and the oven is cool. Cleaning a hot oven can cause burns.

Clean the oven regularly to keep all parts free of grease that could catch fire. Do not allow grease to accumulate.

Always follow the manufacturer's recommended directions for use of kitchen cleaners and aerosols. Be aware that excess residue from cleaners and aerosols may ignite causing damage and injury.

Clean ventilating hoods frequently. Grease should not be allowed to accumulate on the hood or filter. Follow the manufacturer's instructions for cleaning hoods.

IMPORTANT INSTRUCTIONS FOR SELF-CLEANING OVENS

- Clean only the parts listed in this manual. Before using self-clean, remove the broiler pan, any food, utensils, and bakeware from the oven. Remove oven racks unless otherwise instructed.
- Do Not Use Oven Cleaners. No commercial oven cleaner or oven liner protective coating of any kind should be used in or around any part of the oven.

Save these instructions for future reference.

IMPORTANT SAFETY INSTRUCTIONS

Read all instructions before using this appliance.

- Do Not Clean Door Gasket. The door gasket is essential for a good seal. Care should be taken not to rub, damage, or move the gasket.
- Some birds are extremely sensitive to the fumes given off during the self-clean cycle of any oven. Move birds to another well-ventilated room.

⚠ CAUTION DO NOT TOUCH HEATING ELEMENTS OR INTERIOR SURFACES OF OVEN - Heating elements may be hot even though they are dark in color. Interior surfaces of an oven become hot enough to cause burns. During and after use, do not touch, or let clothing or other flammable materials contact heating elements or interior surfaces of oven until they have had sufficient time to cool. Other surfaces of the appliance may become hot enough to cause burns - among these surfaces are (identification of surfaces - for example, oven vent openings and surfaces near these openings, oven doors, and windows of oven doors).

GROUNDING INSTRUCTIONS

⚠ WARNING Avoid fire hazard or electrical shock. Failure to follow this warning may cause serious injury, fire, or death.

This appliance must be supplied with the proper voltage and frequency, and connected to an individual, properly grounded branch circuit, protected by a circuit breaker or fuse.

It is the responsibility and obligation of the consumer to contact a qualified installer to assure that the electrical installation is adequate and is in conformance with all local codes and ordinances.

See the installation instructions packaged with this appliance for complete installation and grounding instructions.

PRODUCT RECORD

In this space below, record the date of purchase, model and serial number of your product. You will find the model and serial number printed on an identification plate. See Figure 1 for serial plate location.

Model No. _____

Serial No. _____

Date of Purchase _____

Save sales receipt for future reference.

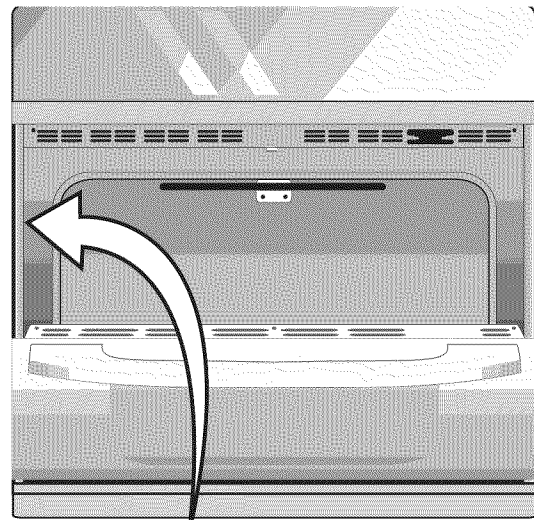

Figure 1: Serial plate location

To locate the serial plate, open the oven door. The serial plate is attached to the left side of the oven frame.

Save these instructions for future reference.

Before Setting Oven Controls

Oven Vent Location

The oven vent is located under the control panel. When the oven is on, warm air passes through this vent. This venting is necessary for proper air circulation in the oven and good baking results. Do not block oven vent. Steam or moisture may appear near the oven vent. This is normal.

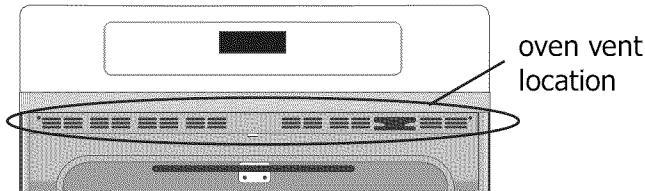

Figure 2: Oven vent location

Removing, Replacing, and Arranging Oven Racks

⚠ WARNING Protective Liners — Do not line the oven walls, racks, bottom, or any other part of the oven with aluminum foil. Doing so will alter heat distribution, produce poor baking results, and may cause permanent damage to the oven interior. During self clean temperatures, the oven will be hot enough to melt foil. Only use aluminum foil as recommended in this manual. Improper installation of these liners may result in risk of electric shock or fire.

⚠ CAUTION Always use pot holders or oven mitts when using the oven. When cooking, the oven interior and exterior, as well as the oven racks, will become very hot which can cause burns.

To Arrange: Always arrange the oven racks when the oven is cool (prior to operating the oven).

To Remove: Pull the oven rack straight forward until it reaches the stop position. Lift up front of oven rack slightly and slide out.

To Replace: Place the oven rack on the rack guides on both sides of oven walls. Tilt the front of oven rack upward slightly and slide the oven rack back into place. Be sure oven racks are level before using.

Important: Be sure to remove all oven racks and accessories before starting a self clean cycle. If the oven racks are not removed, they may discolor.

Important: Some models are equipped with a cooling fan that runs during the cooking process to cool internal electronic components. It is normal for this fan to continue to run for an extended period of time, even when the oven is off.

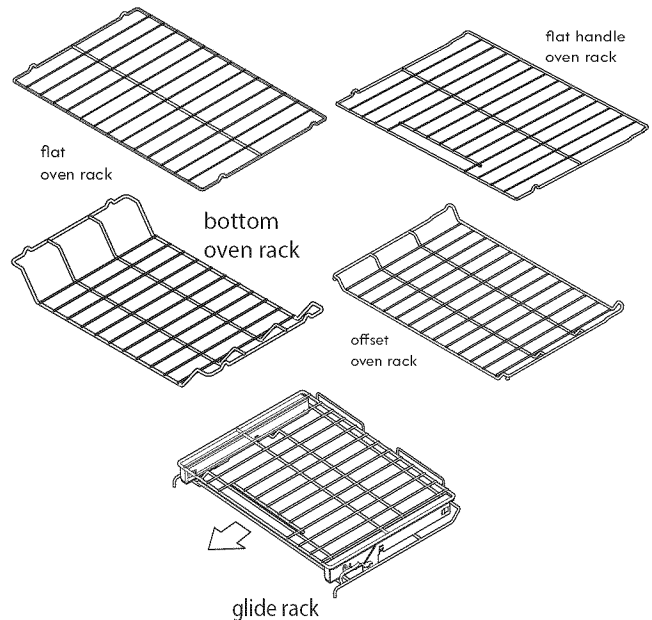

Figure 3: Oven rack types

Oven Rack Descriptions

- Flat oven racks (or the flat handle oven rack) may be used for most cooking needs and may be placed in most oven rack positions.
- The offset oven rack (some models) provides additional stepdown positions from the standard flat rack design. The offset design positions the base of the rack about 1/2 of a rack position lower than the flat rack and may be used in most oven rack positions.
- To maximize oven cooking space, place the bottom oven rack (some models) in the lowest rack position for baking or roasting large cuts of meat.
- The fully extendable oven glide rack allows you to effortlessly extend your food away from the oven.

Air Circulation in the Oven

For best baking results allow 2-4" (5-10 cm) around the bakeware for proper air circulation and be sure pans and bakeware do not touch each other, the oven door, sides or back of the oven cavity. Hot air must be able to circulate around the bakeware in the oven for even heat to reach around the food.

Before Setting Oven Controls

Glide Racks

The glide rack is an extendable rack that makes food preparation easier. It has glide tracks that allow the rack to be pulled away from the oven without rubbing the sides of the oven wall.

Removing and Replacing the Oven Glide Racks

To remove the oven glide rack:

⚠ CAUTION Always use pot holders or oven mitts when using the oven. When cooking, the oven interior and exterior, as well as the oven racks, will become very hot which can cause burns.

⚠ CAUTION Always remove/replace the oven racks before turning on the oven (when the oven is cool).

1. Lift up on the release lever located across the lower front of the rack, as shown in Figure 4.
2. While holding up the release lever (Figure 5), pull the glide rack out of the oven until the stop position is reached, use two hands if necessary.
3. Using both hands, grasp the upper and lower portions of the glide rack (Figure 6).
4. Lift up the front of the rack slightly and continue to pull the rack away from the oven.
5. Be sure to grasp both upper and lower rack portions together when removing or handling the glide rack. The rack portions move independently and are difficult to handle unless held together.

To replace the glide rack:

⚠ CAUTION Always use pot holders or oven mitts when using the oven. When cooking, the oven interior and exterior, as well as the oven racks, will become very hot which can cause burns.

⚠ CAUTION Always remove/replace the oven racks before turning on the oven (when the oven is cool).

1. Grasp both upper and lower portions of the glide rack (Figure 6).
2. Lift and hold the rack level between the oven cavity walls.
3. Tilt the front of the rack upward slightly and slide the rack completely into position. Some force may be necessary to make sure the oven rack has snapped into place.

Important note: To prevent possible damage to the oven, do not attempt to close the oven door until all the oven racks are fully positioned inside the oven cavity.

Note: For instructions on how to best clean these oven racks, see “Caring for Your Porcelain Enameled Glide Racks” on page 28.

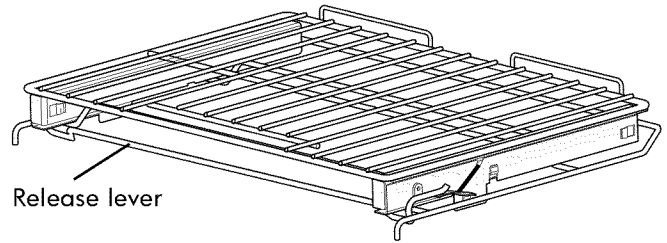

Figure 4: Extensible glide rack with release lever in locked position

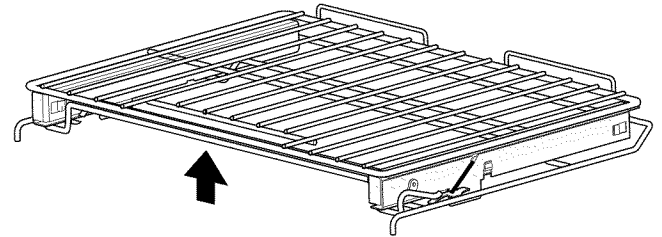

Figure 5: Extensible glide rack with release lever in unlocked position

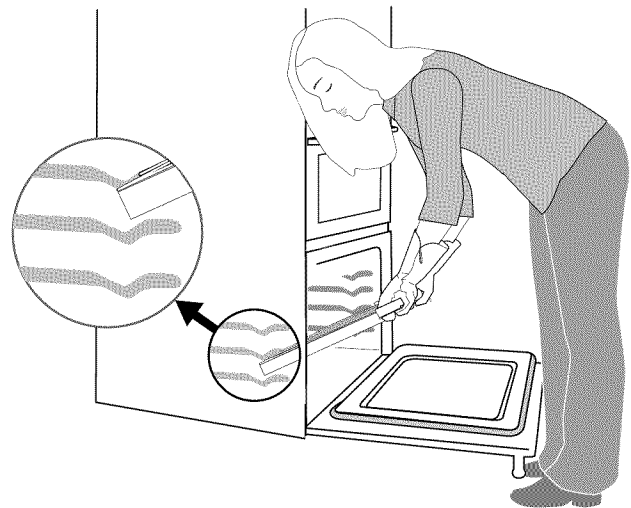
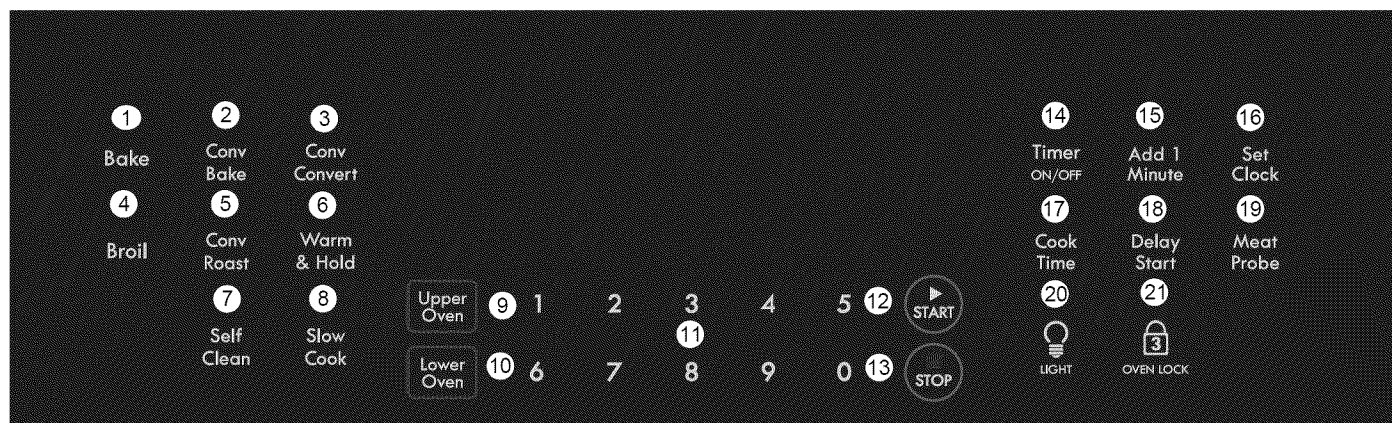

Figure 6: Removing and replacing the oven glide rack

Oven Controls



1. **Bake** - Use to enter the normal baking mode temperature and start a normal bake function, at any temperature from 170°F to 550°F (77°C to 288°C).
2. **Conv Bake** - Use to select the convection baking function, which is used to obtain the best culinary results when baking with multiple pans and racks at any temperature from 170°F to 550°F (77°C to 288°C).
3. **Conv Convert** - Use to convert a standard baking recipe temperature to a temperature for convection baking.
4. **Broil** - Use to select the broil function, at any temperature from 400°F to 550°F (205°C to 288°C).
5. **Conv Roast** - Use to select the convection roasting function, best for cooking tender cuts of beef, lamb, pork, and poultry. Use this mode when cooking speed is desired at any temperature from 170°F to 550°F (77°C to 288°C).
6. **Warm & Hold** - Use to select the Warm and Hold function, best for keeping oven cooked foods warm after cooking has finished for up to three hours.
7. **Self Clean** - Use to select the function that cleans the oven with high temperatures, which eliminate soils completely or reduces them to a fine powdered ash you can wipe away with a damp cloth.
8. **Slow Cook** - Use to select the slow cook function, which cooks food more slowly, at lower temperatures and provides cooking results much the same way as a Slow Cooker or Crock-Pot.
9. **Upper Oven** - Used to select the upper oven.
10. **Lower Oven** - Used to select the lower oven.
11. **0 thru 9 Numeric Keys** - Use to enter temperatures and cooking times, and use to enter time of day when setting clock.
12. **START** - Use to start all oven functions.
13. **STOP** - Use to stop any cooking function except time of day and timer.
14. **Timer ON/OFF** - Use to set or cancel the minute timer. The minute timer does not start or stop cooking.
15. **Add 1 Minute** - Each press of this feature adds one minute of time to an active timer. Pressing **Add 1 Minute** will start timer when timer is idle.
16. **Set Clock** - Use with numeric keys to set the time of day.
17. **Cook Time** - Use to set a specific amount of time needed for cooking. Automatically cancels cooking process at end of set time.
18. **Delay Start** - Use to set a delay cooking feature or delay self clean.
19. **Meat Probe** - Use to check the internal temperature of such meats as roasts, hams, or poultry without any guesswork. For some foods, especially poultry and roasts, testing the internal temperature is the best method to insure properly cooked meats.
20. **LIGHT** - Use to turn oven light ON and OFF
21. **OVEN LOCK** - Use to lock oven door and the control panel.

Oven Controls

Minimum and Maximum Control Settings

All of the features listed have minimum and maximum time and temperature settings that may be entered into the control. An entry acceptance beep will sound each time a key is touched. An entry error tone (three short beeps) will sound if the entry of the temperature or time is below the minimum allowable setting or above the maximum setting for the cooking feature. The error tone will also sound any time a key is pressed if the entry is determined to be an invalid selection.

Table 1: Minimum and maximum control settings

Feature	Min. Temp. or Time	Max. Temp. or Time
Bake	170°F (77°C)	550°F (288°C)
Meat Probe	140°F (60°C)	210°F (99°C)
Broil	400°F (205°C)	550°F (288°C)
Timer	1 Min	11 Hrs. 59 Mins.
Self Clean	2 Hours	4 Hours
Conv Bake	170°F (77°C)	550°F (288°C)
Conv Roast	170°F (77°C)	550°F (288°C)
Slow Cook	LO 225°F (108°C)	HI 275°F (134°C)
Meat Probe	140°F (60°C)	210°F (99°C)
Warm & Hold	170°F (77° C)	3 hours
Cook Time	1 Min.	11:59
Delay time 12hr	1:00	12:59
Delay time 24hr	0:00	23:59
Clock 12hr	1:00	12:59
Clock 24hr	0:00	23:59

Setting The Clock

When the appliance is first powered up, 12:00 will flash in the display (Figure 7). The time of day must first be set before operating the oven.



Figure 7: 12:00 in display before setting the clock

To set clock to 1:30:

1. Press **Set Clock**.
2. Enter 1 3 0 using numeric keys.
3. Press .

Important note:

The clock cannot be changed when a Cook Time, Self Clean, Delay Start, or cooking feature is active.

Setting 12 Hour or 24 Hour Display Mode

The clock display mode allows you to select 12 hr or 24 hr modes. The factory pre-set clock display mode is 12 hours.

To set 12 hr or 24 hr display mode:

1. Press and hold **Set Clock** for 3 seconds.
2. Press **Self Clean** to toggle between 12 Hr day or 24 Hr day display modes (Figure 8).
3. Press  to accept choice.



Figure 8: 12 Hr dAY (L) and 24 Hr dAY settings (R)

Changing Temperature Display to Fahrenheit (°F) or Celsius (°C)

The oven control is preset for temperatures in °F when shipped from the factory. The control can be changed to display either °F or °C oven temperatures.

To change the display to °F or °C:

1. Press and hold **Broil** for 3 seconds.
2. Once F (or C) appears in the display, press **Self Clean** to toggle between Fahrenheit and Celsius temperature display modes.
3. Press  to accept choice.

Important note:

The oven temperature display cannot be changed during the cooking process or if a Delay Start has been set or Self Clean is active.

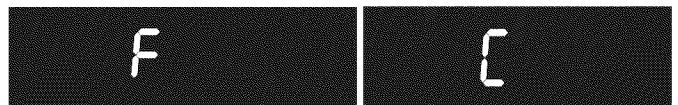

Figure 9: Display showing Fahrenheit (L) and Celsius (R)

Changing Between Continuous Bake Setting or 12 Hour Energy Saving

The oven control has a factory preset built-in 12 Hour Energy Saving feature that will turn off the oven if the oven is left on for more than 12 hours. The control may be programmed to override this feature to bake continuously.

To change between continuous bake or 12 Hour Energy Saving feature:

1. Press and hold **Timer ON/OFF** for 3 seconds
2. Press **Self Clean** to toggle between 12 Hour OFF or Stay On feature (Figure 10).
3. Press  to accept choice.



Figure 10: 12 hr energy saving (L) and continuous setting (R)

Setting Silent or Audible Control mode

Silent mode allows the oven control to operate without audible tones. The control may be programmed for silent operation and later reset to operate with all the normal audible tones.

To set for silent or audible mode:

1. Press and hold **Delay Start** for 3 seconds.
2. Press **Self Clean** to toggle between **bEEP On** or **bEEP OFF** (Figure 11).
3. Press  to accept the choice.



Figure 11: Display showing audible (L) and silent operation (R)

Setting Oven Controls Lockout

The control may be programmed to lock the oven door and lock the oven control keys.

To activate the oven lockout features:

1. Be sure oven door is completely closed.
2. Press **Upper Oven** or **Lower Oven**.
3. Press and hold **OVEN** and **LOCK** for 3 seconds. **DOOR** and **LOCKED** will appear in the display and start flashing. The motor driven door latch mechanism will begin locking the oven door automatically. Do not open the oven door. Allow about 15 seconds for the oven door to completely lock. Once door is locked, **Loc** will appear in the display. **DOOR** and **LOCKED** will stop flashing.

To cancel the oven lockout feature:

1. Press **Upper Oven** or **Lower Oven**.
2. Press and hold **OVEN LOCKED** for 3 seconds. The motor door latch will begin unlocking the oven door automatically. Do not open the oven door. Allow about 15 seconds for the oven door to completely unlock.
3. When the **Loc** message no longer displays, the oven door may be opened, and the oven control keypad will be available for use.

Important note:

- To avoid damage to the oven door latching mechanism, do not attempt to open or close the oven door whenever the **DOOR and LOCKED** messages are displayed.
- If a control key is pressed when oven lockout is active, the control will triple beep indicating the key action is not available when the oven lockout feature is active.

Oven Controls

Setting Timer

The minute timer allows you to track your cooking times without interfering with the cooking process. The timer may be set from a minimum time of 1 minute to a maximum of 11 hours and 59 minutes.

To set timer for 5 minutes:

1. Press **Timer ON/OFF**
2. Enter **5** using numeric key.
3. Press  to start timer. When set time ends, **End** will show in the display, and the control will sound a beep three times every 30 seconds until **Timer ON/OFF** key is pressed.

To cancel the timer when active, press **Timer ON/OFF** again.

Important note:

- The timer does not start or stop the cooking process. It serves as an extra minute timer that will beep when the set time has run out. The timer may be used alone or while using any of the other oven functions.
- When timer is set for more than 1 hour, it will display hours and minutes until 1 hour remains. When less than 1 hour remains, the display counts down in minutes and seconds. With less than 1 minute remaining, only seconds will display.
- If the timer is active during a cooking process, the timer will show in the display. To view the status of any other active oven function, press the key of the cooking function once, and it will appear in the display for a few seconds.

Add 1 Minute

Use **Add 1 Minute** to set additional minutes to the timer. Each press of the key will add 1 minute. If **Add 1 Minute** is pressed when the timer is not active, the timer will activate and begin counting down from 1 minute.

To add 2 minutes to the timer:

- Press **Add 1 Minute** twice. When set time ends, **End** will show in the display, and the control will sound a beep three times every 30 seconds until **Timer ON/OFF** key is pressed.

To cancel the timer when active, press **Timer ON/OFF**.

Operating Oven Lights

The interior oven lights will automatically turn on when the oven door is opened. The oven light will not operate during the self clean cycle. It will remain off during **Self Clean**.

1. Press **Upper Oven** or **Lower Oven**.
2. Press  to turn the interior oven lights on and off whenever the oven door is closed.

The interior oven lights are located in the rear of the oven interior and are covered with a glass shield. The glass shield protects the bulb from high temperatures and should always be in place whenever the oven is in use. The oven light will not operate during a self clean cycle.

To replace the interior oven light, see “Replacing the Oven Light” on page 29.

Setting Bake

Use the bake feature whenever the recipe calls for baking using normal temperatures. A reminder tone will sound indicating when the set bake temperature is reached and to place the food in the oven. The bake element will cycle on and off to maintain the set bake temperature for precise baking. During preheat, the convection fan will run to help heat the oven to the set temperature. The fan will pulse on and off after the set temperature is reached.

Bake may be set for any oven temperature between 170°F (77°C) to 550°F (288°C).

To set Bake for oven temperature of 425°F (218°C):

⚠ CAUTION Always use pot holders or oven mitts when using the oven. When cooking the oven interior, oven racks, and cooktop will become very hot which can cause burns.

⚠ CAUTION Do not bake foods directly on the oven bottom. To avoid damaging the oven interior and surfaces, always bake foods in the oven using bakeware positioned on an oven rack.

1. Press **Upper Oven** or **Lower Oven**.
2. Press **Bake**.
3. Enter **4 2 5** using numeric keys.
4. Press **START**.

To cancel Bake at any time press **STOP**.

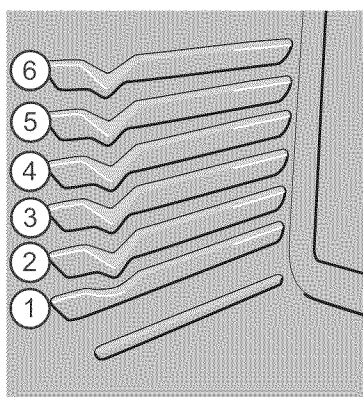

Figure 12: Oven rack positions

Important note:

If Bake is active without a cook time setting, the oven will remain on for 12 hours before turning off automatically unless it is cancelled. To bake longer than 12 hours, see “Changing Between Continuous Bake Setting or 12 Hour Energy Saving” on page 11 for instructions.

Baking Tips:

- Fully preheat the oven before baking items like cookies, biscuits and breads.
- When using any single rack, position the rack so that the food is in the center of the oven.
- Dark or dull pans absorb more heat than shiny bakeware, resulting in dark or overbrowning of foods. It may be necessary to reduce the oven temperature or cook time to prevent overbrowning of some foods. Dark pans are recommended for pies. Shiny pans are recommended for cakes, cookies, and muffins.
- For batter and dough-based baked goods such as cakes, pastries, and breads, use the convection bake function for best results.
- Convection baking is preferred for multiple rack cooking.
- For best results when baking cakes or cookies using two oven racks, place racks in positions 1 and 5 (Figure 12) and place pans as shown in Figure 13. Use flat rack in position 5 and glide rack in position 1.
- When baking using two oven racks, position bakeware as shown in Figure 13. Allow at least 2 inches (5 cm) of space between bakeware for proper air circulation.
- Do not open the oven door too often. Opening the door will reduce the temperature in the oven.
- Glass bakeware is a slow heat conductor. May require reducing oven temperature.

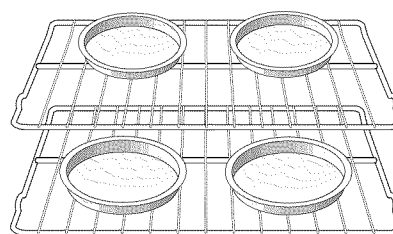

Figure 13: Baking on multiple levels/racks

Oven Controls

Setting Cook Time

Cook time is used when a recipe calls for a specific temperature and cook time. Following the recipe's suggested cook time can help ensure the best possible results. The oven will turn on immediately and stop automatically after the set cook time ends.

To program oven to bake with oven default temperature of 350°F (177°C) and to shut-off after 30 minutes:

⚠ WARNING Food poisoning hazard. Do not let food sit for more than one hour before or after cooking. Doing so can result in food poisoning or sickness. Foods that can easily spoil such as milk, eggs, fish, meat or poultry, should be chilled in the refrigerator first. Even when chilled, they should not stand in the oven for more than 1 hour before cooking begins, and should be removed promptly when finished cooking.

⚠ CAUTION Always use pot holders or oven mitts when using the oven. When cooking the oven interior, oven racks, and cooktop will become very hot which can cause burns.

1. Press **Upper Oven** or **Lower Oven**.
2. Press **Bake**.
3. Press **Cook Time**.
4. Enter **3 0** using numeric keys.
5. Press .

When the programmed cook time ends:

End will appear in the display window, and the oven will shut-off automatically (Figure 14). The oven control will beep three times every 30 seconds as a reminder until  is pressed.



Figure 14: Display showing cooking has ended

Important note:

- The Cook Time feature may be set with Bake, Broil, Conv Bake, Conv Roast, and Slow Cook. Cook Time cannot be set with Self Clean.
- The maximum Cook Time setting is 11 hours and 59 minutes unless oven is set for continuous cooking.
- To check the time remaining during a timed cooking function, press **Cook Time** once and the time remaining will appear in the display momentarily.

Setting Delay Start

Delay Start sets a delayed starting time to oven cooking or cleaning functions. Prior to setting a delay start, be sure the time of day is set correctly.

To program oven for a Delay Start beginning at 5:30, to shut-off automatically after 50 minutes and for baking at 375°F (190°C):

⚠ WARNING Food poisoning hazard. Do not let food sit for more than one hour before or after cooking. Doing so can result in food poisoning or sickness. Foods that can easily spoil such as milk, eggs, fish, meat or poultry, should be chilled in the refrigerator first. Even when chilled, they should not stand in the oven for more than 1 hour before cooking begins, and should be removed promptly when finished cooking.

1. Press **Upper Oven** or **Lower Oven**.
2. Press **Bake**.
3. Enter **3 7 5** using numeric keys.
4. Press **Cook Time**.
5. Enter **5 0** using numeric keys.
6. Press **Delay Start**.
7. Enter **5 3 0** using numeric keys.
8. Press .
9. The oven will begin cooking at 5:30 and turn off automatically after 50 minutes.

When the programmed cook time ends:

End will appear in the display window, and the oven will shut off automatically (Figure 14). The oven control will beep three times every 30 seconds as a reminder until  key is pressed.

Important note:

- Delay Start may be set using a 24 hr clock. To set clock for 24 Hr operation, see "Setting 12 Hour or 24 Hour Display Mode" on page 10 for more information.

Important:

To use the Delay Start function with any of the oven cooking or cleaning functions, first choose the desired function, the temperature, the cook time--if any, and then select the desired start time.

Setting Broil

Use the broil function to cook meats that require direct exposure to radiant heat for optimum browning results. The Broil feature is factory preset to broil at 550°F. The Broil function temperature may be set at any temperature between 400°F (205°C) and 550°F (288°C).

The suggested broil settings in Table 2 are recommendations only. Depending on cooking preferences you can increase or decrease cooking times or move food to a different rack position. If the food you are broiling is not listed in n Table 2, follow the instructions provided in your cookbook and watch the item closely.

To set Broil with the default broil oven temperature of 550°F:

⚠ CAUTION Always use pot holders or oven mitts when using the oven. When cooking, the oven interior, oven racks, and cook-top will become very hot which can cause burns.

⚠ WARNING Should an oven fire occur, keep oven door closed and turn off the oven. If the fire continues, throw baking soda on the fire or use a fire extinguisher. Do not put water or flour on the fire. Flour may be explosive and water can cause a grease fire to spread and cause personal injury.

1. Position bakeware in oven to the preferred rack position (Figure 16). Close oven door.
2. Press **Upper Oven** or **Lower Oven**.
3. Press **Broil**.
4. Press **START**. If desired, preheat for 2 minutes before placing item in oven. Broil with the oven door closed.
5. Place item in oven on broil pan and insert. Broil on one side until food is browned; turn and broil other side until done to your satisfaction.

Table 2: Suggested Broil Settings^{1, 2}

Food	Rack Position	Setting	Cook time in minutes		Internal Temperature	Doneness
			1st side	2nd side		
Steak, 1 inch thick	5th or 6th	550°F (288°C)	6	4	145°F (63°C)	Medium
Steak, 1 inch thick	4th or 5th	550°F (288°C)	7	5	160°F (71°C)	Medium-well
Steak, 1 inch thick	4th or 5th	550°F (288°C)	8	7	170°F (77°C)	Well
Pork Chops (3/4" thick)	4th	550°F (288°C)	8	6	170°F (77°C)	Well
Chicken (bone-in)	4th	450°F (232°C)	20	10	170°F (77°C)	Well
Chicken (boneless)	4th	450°F (232°C)	8	6	170°F (77°C)	Well
Fish	4th	550°F (288°C)	as directed		170°F (77°C)	Well
Shrimp	3rd	550°F (288°C)	as directed		170°F (77°C)	Well
Hamburger, 1 inch	4th or 5th	550°F (288°C)	9	7	145°F (63°C)	Medium
Hamburger, 1 inch	3rd or 4th	550°F (288°C)	10	8	170°F (77°C)	Well

1. Cook times are suggestions and should only be used as a guide.
2. Use the offset or half-racks (if available) only in the top position.

6. When finished broiling, press **STOP**.
7. To cancel Broil at any time, press **STOP**.

Important notes:

- If you attempt to use the Meat Probe feature, it will shut off the Broil function.
- Broiling is direct heat cooking and will produce smoke. If smoke is excessive, place food further away from the broil element.
- Always arrange oven racks when the oven is cool.
- For best results when broiling, use a broil pan with broil pan insert designed to drain the fat from the food and help avoid spatter and reduce smoking. To purchase them, call Sears at 1-800-4-MY-HOME (1-800-4663) and order broil pan kit 5304442087.
- When broiling, always pull the oven rack out to the stop position before turning or removing food.

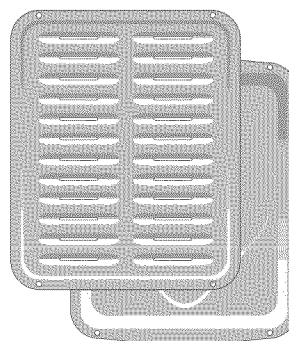

Figure 15: Broiler pan/insert

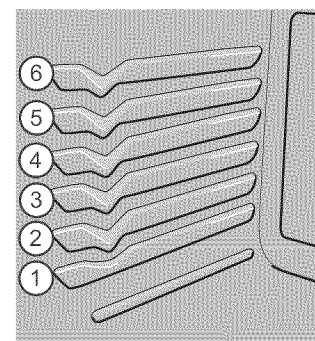

Figure 16: Rack positions

Setting Convection Bake

Convection functions use a fan to circulate the oven's heat uniformly and continuously around the oven (Figure 17). This improved heat distribution allows for fast, even baking and browning results. It also gives better baking results when using two oven racks at the same time. Heated air flows around the food from all sides, sealing in juices and flavors. Breads and pastry brown more evenly. Most foods baked in a standard pan will bake faster and more evenly with the convection feature. Multiple rack baking may slightly increase bake time for some foods, but the overall result is time saved.

Convection Bake may be set for any oven temperature between 170°F (77°C) to 550°F (288°C).

Benefits of Convection Bake:

- Superior multiple oven rack performance
- Foods bake more evenly
- Foods can bake up to 25 to 30% faster.

Important note:

The convection bake feature is best used when the recipe instructions have been written especially for convection baking. If the recipe instructions are for baking and you wish to use convection baking, follow the "Setting Convection Convert" instructions on page 17. Convection convert will automatically adjust the oven temperature so that convection baking will provide the best possible results.

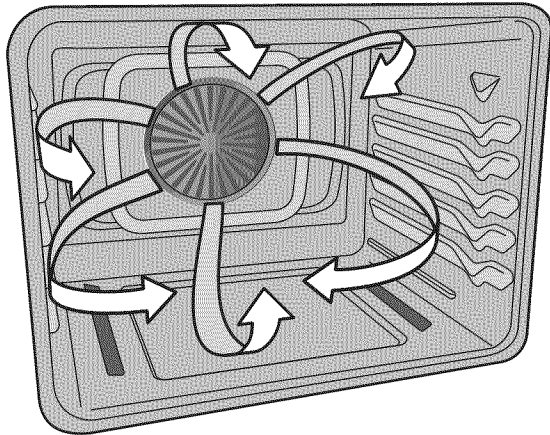

Figure 17: Air movement using convection

To set Conv Bake with a default oven set temperature of 350°F (177°C):

CAUTION Always use pot holders or oven mitts when using the oven. When cooking the oven interior, oven racks, and cooktop will become very hot which can cause burns.

CAUTION Do not bake foods directly on the oven bottom. To avoid damaging the oven interior and surfaces, always bake foods in the oven using bakeware positioned on an oven rack.

1. Press **Upper Oven** or **Lower Oven**.
2. Press **Conv Bake**.
3. Press **START**.

To cancel Conv Bake at any time, press **STOP**.

Important:

- The convection fan will begin rotating once convection bake, convection roast, or convection convert has been activated.
- If the oven door is opened when the convection function is active, the convection fan will stop rotating until the oven door is closed.

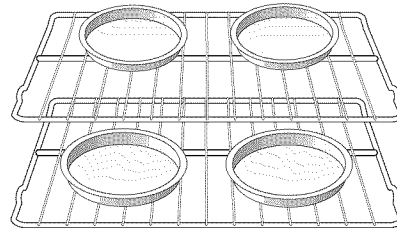

Figure 18: Convection baking on multiple levels/racks

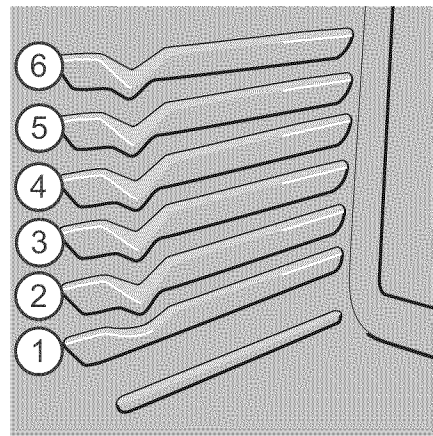

Figure 19: Oven rack positions

Convection Baking/Convection Convert Tips:

- Fully preheat the oven before baking items like cookies, biscuits, and breads.
- When using any single rack, position the rack so that the food is in the center of the oven.
- Dark or dull bakeware absorbs more heat than shiny bakeware resulting in dark or overbrowning of foods. It may be necessary to reduce the oven temperature or cook time to prevent overbrowning of some foods. Dark bakeware is recommended for pies. Shiny bakeware is recommended for cakes, cookies, and muffins.
- When using convection, use bakeware with low sides. This allows the air to circulate around the food evenly.
- Because most food items will cook faster and more evenly with the convection feature, it is advisable to reduce recipe's recommended temperature by 25° for best results. Follow the recipe's instructions using the minimum recommended cook time.
- When using convection bake, cook time reductions may vary depending on the amount and type of food being cooked.
- For batter and dough-based baked goods such as cakes, pastries, and breads, use the convection bake function for best results. Place the pans as shown in Figure 18.
- Do not open the oven door often. Opening the door will reduce the temperature in the oven and may increase bake time.
- Glass bakeware may require reduced temperatures.
- When using Convec Bake, cook time reductions may vary depending on the amount and type of food being cooked.
- For best results when baking cakes or cookies using two oven racks, place racks in positions 1 and 5 (Figure 19) and place pans as shown in Figure 18. Use flat rack in position 5 and glide rack in position 1.
- When baking using two oven racks, position bakeware as shown in Figure 18. Allow at least 2 inches (5 cm) of space between bakeware for proper air circulation.

Setting Convection Convert

Pressing Conv Convert automatically converts the cooking temperature entered for any standard baking recipe to the lower temperature required for convection baking.

When convection convert is used with a timed convection bake setting of 20 minutes or more, the convection convert function will display a **CF** message as a reminder to check food when the bake time is 75% complete (Figure 20). At this time the oven control will sound 1 long beep at regular intervals until the set cook time has finished.

Important note:

- Convection convert may only be used with the convection bake function and with a minimum of 20 minutes cook time.
- The convection fan will begin rotating once convection bake, convection roast, or convection convert has been activated. If the oven door is opened when any convection function is active, the convection fan will stop rotating until the oven door is closed.



Figure 20: Check Food reminder shown in display.

To program oven for Convection Convert with oven default temperature of 350°F (177°C) and to shut-off after 30 minutes:

CAUTION Always use pot holders or oven mitts when using the oven. When cooking the oven interior, oven racks, and cooktop will become very hot which can cause burns.

1. Press **Upper Oven** or **Lower Oven**.
2. Press **Conv Bake**.
3. Press **Cook Time**.
4. Enter **3 0** using numeric keys.
5. Press **Conv Convert**.
6. Press  .

To cancel convection convert at any time, press  .

Oven Controls

To program oven for Convection Convert with recipe temperature of 425°F (218°C) and to shut-off after 30 minutes:

1. Press **Upper Oven** or **Lower Oven**.
2. Press **Conv Bake**.
3. Enter **4 2 5** (2 1 8) using numeric keys.
4. Press **Cook Time**.
5. Enter **3 0** using numeric keys.
6. Press **Conv Convert**. Set bake temperature will convert to a lower temperature and begin baking process.
7. Press .

To cancel convection convert at any time, press .

Setting Convection Roast

The convection roast function combines a cook cycle with the convection fan to roast meats and poultry. Meats cooked using the convection roast function will be juicier and poultry will be crisp on the outside while staying tender and moist on the inside.

Convection roast may be set for any oven temperature between 170°F (77°C) to 550°F (288°C).

Suggestions for Convection Roast:

- Preheating is not necessary when roasting foods using Convection roast. Since convection roast cooks food faster, reduce the cook time by 25% from the recommended cook time of your recipe. If necessary, increase cooking time until the desired doneness is obtained.
- The broiler pan will catch grease drippings, and the grid will help prevent splatters. The roasting rack will hold the meat. Use the offset rack on rack position 1.
- Do not cover foods when dry roasting as this will prevent the meat from browning properly.

To set Convection Roast with a default oven set temperature of 350°F (177°C):

1. Press **Upper Oven** or **Lower Oven**.
2. Press **Conv Roast**.
3. Press .

To cancel Conv Roast at any time, press .

Important note:

- The convection fan will begin rotating once convection bake, convection roast, or convection convert has been activated.
- If the oven door is opened when any convection function is active, the convection fan will stop rotating until the oven door is closed.
- It is not recommended to roast chicken on a roasting rack. Use a deep pan instead and roast on rack position 1.

Setting Slow Cook

The Slow Cook feature cooks foods more slowly and at lower oven temperatures for longer periods of time. Slow Cook is ideal for roasting beef, pork and poultry. Slow cooking meats may result in the exterior of meats becoming dark but will not burn the outside as it seals in the meat's juices. Two (2) Slow Cook settings are available, high (Hi) or low (Lo). The high setting is best for cooking foods between 4 and 5 hours. The low setting is best for cooking foods up to 9 hours or longer.

⚠ WARNING Food Poisoning Hazard. Do not let food sit for more than one hour before or after cooking. Doing so can result in food poisoning or sickness. Foods that can easily spoil such as milk, eggs, fish, meat or poultry, should be chilled in the refrigerator first. Even when chilled, they should not stand in the oven for more than 1 hour before cooking begins, and should be removed promptly when finished cooking.

Some tips for best results when using Slow Cook:

- Completely thaw all frozen foods before cooking.
- When using a single oven rack, place in oven rack position 2 or 3. Position racks to accommodate the size of various bakeware when cooking multiple food items.
- Do not open the oven door often or leave the door open when checking foods. If the oven heat escapes often, the Slow Cook time may need to be extended.
- Cover to keep foods moist or use a loose or vented type cover to allow foods to turn crisp or brown.
- Roasts may be left uncovered so browning can occur. Cook times will vary depending on the weight, fat content, bone, and the shape of the roast. Preheating the oven will not be necessary when using the Slow Cook feature.
- Add any cream or cheese sauces during the last hour of cooking.

Important note:

Slow Cook may be used with Cook Time. The maximum cook time for Slow Cook function is 11 hours and 59 minutes. If a longer cook time is desired, set the control to the continuous mode using "Changing Between Continuous Bake Setting or 12 Hour Energy Saving" on page 11 and do not use Cook Time.

To set Slow Cook:

1. Position bakeware in oven and close oven door.
2. Press **Upper Oven** or **Lower Oven**.
3. Press **Slow Cook**. HI will appear in the display indicating the default temperature setting is for high.
4. If a low setting is needed, press **Slow Cook** again to select the low setting.
5. Press  to activate Slow Cook.

To cancel Slow Cook at any time, press .

Warm & Hold

Warm & Hold should only be used with foods that are already at serving temperatures. Warm & Hold will keep cooked foods warm and ready for serving for up to 3 hours after cooking has finished. After 3 hours the Warm & Hold will shut-off automatically. Warm & Hold will keep the oven temperature at 170° F (77°C).

To set Warm & Hold:

⚠ CAUTION Always use pot holders or oven mitts when using the oven. When cooking the oven interior, oven racks, and cooktop will become very hot which can cause burns.

1. If needed, arrange oven racks and place cooked food in oven.
2. Press **Upper Oven** or **Lower Oven**.
3. Press **Warm & Hold**. Hld will appear in the display. If no other keys are touched within 25 seconds, the request for Warm & Hold will clear.
4. Press . Warm & Hold will automatically turn on and then turn off after 3 hours unless cancelled.

To turn Warm & Hold off at any time, press .

To add Warm & Hold to turn ON after baking 45 minutes with a set temperature of 425°F (218°C):

1. Press **Upper Oven** or **Lower Oven**.
2. Press **Bake**.
3. Enter **425** on numeric keys.
4. Press **Cook Time**.
5. Enter **4 5** using numeric keys.
6. Press **Warm & Hold**. Hld will appear in the display.
7. Press  to accept. When the cook time is over, the Warm & Hold will automatically turn ON. The Warm & Hold function will automatically turn OFF after 3 hours.

To turn Warm & Hold off at any time, press .

Important note:

- Warm & Hold will maintain the oven temperature at 170° F (77°C) for 3 hours.
- Warm & Hold may be set when finished cooking or may be added to automatically turn on after cooking using Cook Time. Delay Start may also be added.

Oven Controls

Meat Probe

The Meat Probe feature is only available in the upper oven. When cooking meat such as roasts, hams, or poultry, use the meat probe function to check the internal temperature without guesswork. For some foods, especially poultry and roasts, testing the internal temperature is the best method to insure properly cooked meats. The following temperature settings apply to the probe function:

- Default: 170°F (77°C)
- Minimum: 140°F (60°C)
- Maximum: 210°F (99°C)

Important:

- For this model, the Meat Probe feature is only available in the upper oven.
- Use only the meat probe supplied with appliance. Using any other probe or device may result in damage to appliance and the meat probe receptacle.
- Never leave or store meat probe inside oven.
- Defrost food completely before inserting meat probe to avoid damaging probe.

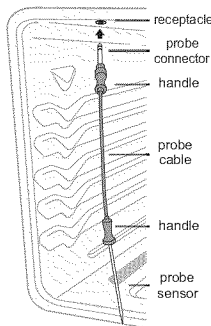

Figure 21: Probe receptacle location/insertion point

The probe receptacle is located at the top of the oven cavity as shown in Figure 21.

Proper meat probe placement

Always insert meat probe so that the probe tip rests in the center of the thickest part of meat. Do not allow meat probe to touch bone, fat, gristle, or bakeware.

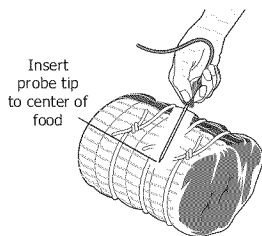

Figure 22: Proper probe placement

Tips for Probe Placement

- For bone-in ham or lamb, insert meat probe into the center of lowest large muscle or joint.
- For dishes such as meat loaf or casseroles, insert meat probe into center of food.
- When cooking fish, insert meat probe just above the gill.

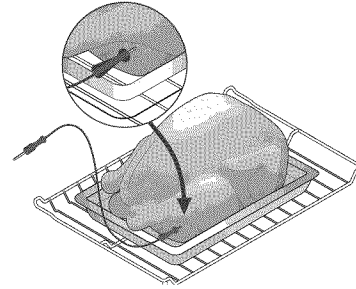

Figure 23: Proper probe placement

For whole poultry or turkey, insert meat probe into the thickest part of inner thigh, below the leg (Figure 23).

To set meat probe:

CAUTION Always use pot holders or oven mitts when using the oven. When cooking, the oven interior and exterior, as well as the oven racks, will become very hot which can cause burns.

CAUTION Handle the meat probe carefully when inserting and removing from food or probe receptacle. Do not use kitchen utensils, such as tongs, to pull on meat probe cable when inserting or removing from food or receptacle. Use the provided handle, as shown in Figure 21. To avoid possibility of burns after cooking, carefully unplug meat probe using a pot holder to protect hands.

1. Prepare the food and properly insert the meat probe into the food. Do not preheat or start cooking before properly inserting the meat probe. Probe should be inserted into the food and receptacle while the oven is still cool.
2. Place the prepared food on the desired oven rack position and slide into the oven.
3. Plug the meat probe into the upper oven's probe receptacle located on the top of the oven cavity. When the meat probe is correctly plugged in to receptacle, the probe icon will illuminate on the oven control display.
4. Press **Upper Oven**.
5. Set the oven control for Bake, Conv Bake, or Conv Roast and the desired oven temperature. The meat probe cannot be set with Broil or Self Clean.
6. To set the target temperature, press **Meat Probe** once, then enter the desired target internal temperature using the numeric key pads (default setting is 170°F/ 77°C). Press **START** to accept the meat probe target temperature. Close the oven door.

7. During the cooking process the actual meat probe temperature will display by default. To view the target temperature, press the Meat Probe once. After 3 seconds the display will show the actual meat probe temperature. If the target temperature needs to be changed during the cooking process, press **Meat Probe** once and use the numeric keys to adjust the target temperature. Press  to accept any change.

Important note: If you decide to change the target temperature during the cooking process, the maximum temperature that may be set is 210°F (99°C).

8. The oven control will provide one beep when the internal target temperature is reached. By default the oven will automatically change to a Warm & Hold setting. The Warm & Hold function will maintain the oven temperature at 170°F (77°C). Instructions for changing how the oven reacts after reaching the internal target temperature may be found later in this section.
9. Press  to cancel cooking at any time.

Continue/Cancel Cooking

There may be times when you will want to continue or cancel cooking after the probe has reached the target temperature. Be aware that this setting cannot be changed during the cooking process or if a Delay Start has been set.

CAUTION Always use pot holders or oven mitts when using the oven. When cooking, the oven interior and exterior, as well as the oven racks, will become very hot which can cause burns.

To set the oven to continue cooking after reaching the probe target temperature:

1. Press **Meat Probe** and hold for 3 seconds.
2. Press **Self Clean** and toggle until the **Continu** message appears then press  to accept.

To set the oven to cancel cooking and automatically start Warm & Hold after reaching the probe target temperature:

1. Press **Meat Probe** and hold for 3 seconds.
2. Press **Self Clean** and toggle until **CANCEL** message appears then press  to accept.



Figure 24: Probe set to continue cooking



Figure 25: Probe set to cancel cooking

Table 3: USDA recommended minimal internal cooking temps

Food type	Internal temperature
Ground meat and meat mixtures	
Beef, Pork, Veal, Lamb	160°F (71°C)
Turkey, Chicken	165°F (74°C)
Fresh beef, veal, lamb	
Medium rare +	145°F (63°C)
Medium	160°F (71°C)
Well Done	170°F (77°C)
Poultry	
Chicken and Turkey, whole	165°F (74°C)
Poultry Breasts, Roasts	165°F (74°C)
Poultry Thighs, Wings	165°F (74°C)
Duck and Goose	165°F (74°C)
Stuffing (cooked alone or in bird)	165°F (74°C)
Fresh pork-roasts, steaks, and chops	
Medium	160°F (71°C)
Well Done	170°F (77°C)
Ham	
Fresh (raw)	160°F (71°C)
Pre-cooked (to reheat)	140°F (60°C)
Eggs and egg dishes	
Eggs	Cook til yolk/white firm
Egg dishes	160°F (71°C)
Leftovers and Casseroles	165°F (74°C)

The U.S. Department of Agriculture states, "Rare fresh beef is popular, but you should know that cooking it to only 140°F (60°C) means some food poisoning organisms may survive." (Source: Safe Food Book, Your Kitchen Guide, USDA Rev. June 1985.) The lowest temperature recommended by the USDA is 145°F (63°C) for medium rare fresh beef. For beef medium 160°F, well done 170°F

Visit the USDA Food Safety and Inspection website at www.fsis.usda.gov

Oven Controls

Settings Recipe Recall

Use Recipe Recall to recall a bake, convection bake, convection roast, slow cook, cook time, or a cook time with a Warm & Hold added setting. This feature will not work with any other function. One recipe can be saved for each oven.

To program the oven to begin baking immediately and record a recipe (Bake at 425°F):

CAUTION Always use pot holders or oven mitts when using the oven. When cooking the oven interior, oven racks, and cooktop will become very hot which can cause burns.

1. Press **Upper Oven** or **Lower Oven**.
2. Press **Bake**.
3. Press **4 2 5**.
4. Press and hold **START** for at least 3 seconds until a beep indicates that this recipe has been recorded for future recall. If you do not wish to continue cooking at this time, press **STOP**.

To begin baking using a stored recipe:

1. Place food in oven.
2. Press **Upper Oven** or **Lower Oven** where the recipe has been saved.
3. Press **Bake**.
4. Press **START**.
5. The temperature (and cook time, if programmed) is recalled, and the oven will begin cooking the recorded recipe.

Restoring Factory Default Settings

Your appliance was set with predetermined (default) oven control settings. Over time, users may have made changes to these settings. The following options may have been modified since the appliance was new:

- 12 or 24 hr display mode
- Continuous bake or 12 Hour Energy Savings mode
- Silent or audible control
- Oven temperature display (Fahrenheit or Celsius)
- Oven temperature adjustments (UPO)
- Meat probe
- Recipe Recall

To restore oven control to factory default settings:

CAUTION If you choose to restore any of the options to a factory default setting using this method, all of the above user settings will be restored to the factory default settings. This includes the oven temperature offset that will reset to (0) zero.

1. Press and hold **7** on numeric keypad until acceptance tone sounds (about 3 seconds). Three beeps will sound immediately. Ignore them. **PS** will appear in the display.
2. Press . The control has been reset with the default settings.

Adjusting Oven Temperatures

Your appliance has been factory calibrated and tested to ensure accurate baking temperatures. For the first few uses, follow your recipe times and temperature recommendations carefully. If you think the oven is cooking too hot or too cool for your recipe times, you may adjust the control so the oven cooks hotter or cooler than the oven temperature displayed.

The oven temperature may be increased as much as +35°F (+19°C) or decreased -35°F (-19°C) from the factory calibrated settings.

To increase (+) or decrease (-) the oven temperature by 20°F:

1. Press **Upper Oven** or **Lower Oven**.
2. Press and hold **Bake** until the control produces an audible tone (about 3 seconds). The factory offset temperature of 0 (zero) should appear in the display.
3. Enter **2 0** using numeric keys.
4. To offset the oven by -20°F, press **Self Clean** to toggle to the minus (-) setting.
5. Press  to accept change.

Important note:

- Oven temperature adjustments will not change the Broil or Self Clean function temperatures.
- Do not use oven thermometers such as those found in grocery stores to check the temperature settings inside your oven. These oven thermometers may vary as much as 20°F to 40°F degrees from actual temperatures.
- The oven temperature adjustment may be made if your oven control is set to display temperatures in °C. Minimum and maximum settings for Celsius range from plus (+)19°C to minus (-) 19°C.

Setting the Sabbath Feature

(for use on the Jewish Sabbath and Holidays)



For further assistance, guidelines for proper usage and a complete list of models with the Sabbath feature, please visit the web at www.star-k.org.

This appliance provides special settings for use when observing the Jewish Sabbath/Holidays. Sabbath mode disables all audible tones or visual display changes on the oven control. Bake heating is the only cooking feature available while in the Sabbath mode. Oven controls are automatically locked during Sabbath mode.

You must first set the Bake feature and temperature(s) needed for the oven, and the Cook Time and Delay Start options (if needed). Any settings made prior to setting the Sabbath mode will be visible in the displays. The Cook Time option, if set prior to the Sabbath mode, will give one audible alert at the end of Cook Time.

The Sabbath mode will override the factory preset 12 Hour Energy Saving mode and the appliance will stay on until the cooking features are cancelled. If any of the cooking features are cancelled when the appliance is in the Sabbath mode, no audible or visual indicators will be available to verify the cancellation.

If the oven interior lights are needed, be sure to activate them prior to setting the Sabbath mode. Once the oven light is turned on and the Sabbath mode is active, the oven light will remain on until the Sabbath mode is turned off and the oven lights are turned off. The oven door will not activate the interior oven lights when the oven door is opened or closed.

It is recommended that any oven temperature modification made within an active Sabbath mode be followed with two (2) presses of the **START** key. This will insure the oven remains on even if an attempt is made to set the oven temperature outside of its temperature range. If the oven temperature is set outside of the temperature range, the oven will default to the nearest available temperature. Try to set the desired oven temperature again.

⚠ WARNING Food poisoning hazard. Do not let food sit for more than one hour before or after cooking. Doing so can result in food poisoning or sickness. Foods that can easily spoil such as milk, eggs, fish, meat or poultry should be chilled in the refrigerator first. Even when chilled, they should not stand in the oven for more than 1 hour before cooking begins, and should be removed promptly when finished cooking.

To program oven to Bake with default oven temperature of 350°F and activate the Sabbath feature:





1. Be sure the clock is set with the correct time of day.
2. Arrange oven racks, place bakeware in oven and close oven door.
3. Press **Upper Oven** or **Lower Oven**.
4. Press **Bake**.
5. If Cook Time or Delay Start are not needed, skip this step and continue to step 6. If a Cook Time or Delay Start are desired, enter the times at this point. Refer to "Setting Cook Time" and "Setting Delay Start", both on page page 14, for detailed instructions.
6. Press .
7. Press and hold **Cook Time** and **Delay Start** simultaneously for about 3 seconds to set the Sabbath feature. Once the feature is set, **SAb** will appear in the display indicating the oven is properly set for the Sabbath feature (Figure 26).



Figure 26: Oven set for Sabbath baking.

Important note:

- Do not attempt to activate any other oven function except Bake while the Sabbath feature is active. The following keys will function correctly when the Sabbath feature is active: 0-9 number keys, Bake,  and . All other keys should not be used once the Sabbath feature is active.
- You may change the oven temperature once baking has started. Use the numeric keys to enter the oven temperature change (170°F to 550°F) and press  (for Jewish Holidays only).
- Remember that the oven control will no longer provide audible tones or display any further changes when the Sabbath feature is active.
- Remember the oven will shut-off automatically after completing a Cook Time, Delay Start or Warm & Hold and therefore may only be used once during the Sabbath/Jewish Holidays.
- If a Delay Start time longer than 11 hours and 59 minutes is desired, set the oven control for the 24 hour day display mode setting. For detailed instructions, see "Setting 12 Hour or 24 Hour Display Mode" on page 10.

Oven Controls

To turn the oven off and keep the Sabbath feature active:

Press .

To turn off the Sabbath feature:

1. Press and hold both **Cook Time** and **Delay Start** simultaneously for at least 3 seconds to turn the Sabbath feature off.
2. The control will provide an acceptance tone and **SAb** will disappear from the display. The oven is no longer programmed for the Sabbath feature.

What to do during a power failure or power interruption after the Sabbath feature was activated:

Should you experience a power failure or interruption, the oven will shut-off. When power is restored the oven will not turn back on automatically. The oven will remember that it is set for the Sabbath and the oven display will show the message **SF** for Sabbath failure (Figure 27).



Figure 27: Display showing Sabbath failure

The food may be safely removed from the oven while still in the Sabbath feature, however, the oven cannot be turned back on until after the Sabbath/Holidays. After the Sabbath observance, turn off the Sabbath feature. Press and hold both **Cook Time** and **Delay Start** for at least 3 seconds simultaneously to turn the Sabbath feature off. **SF** will disappear from the display and the oven may be used with all normal functions.

Self Clean

A self cleaning oven cleans with very high temperatures well above normal cooking temperatures. The high temperature eliminates soils completely or reduces them to a fine powdered ash you can wipe away afterwards with a damp cloth.

The Self Clean function allows you to set a cleaning time from 2 hours to 4 hours. A 3 hour cleaning time is recommended for normal cleaning, 2 hours for light cleaning, and 4 hours for heavy cleaning.

Read Before Starting Self Clean:

⚠ CAUTION Do not leave small children unattended near the appliance. During the self cleaning cycle, the outside of the oven can become very hot to touch and can cause burns.

⚠ CAUTION Do not line the oven walls, racks, bottom or any other part of the oven with aluminum foil. Doing so will destroy heat distribution, produce poor baking results and cause permanent damage to the oven interior. Aluminum foil will melt to the interior of the oven.

⚠ CAUTION The health of some birds is extremely sensitive to the fumes given off during the self cleaning cycle of any oven. Move birds to another well-ventilated room.

⚠ CAUTION Do not force the door open. This can damage the automatic door locking system. Use caution when opening the oven door after self cleaning. The oven may still be very hot and can cause burns. To avoid possible burns stand to the side of the oven when opening the oven door to allow hot air or steam to escape.

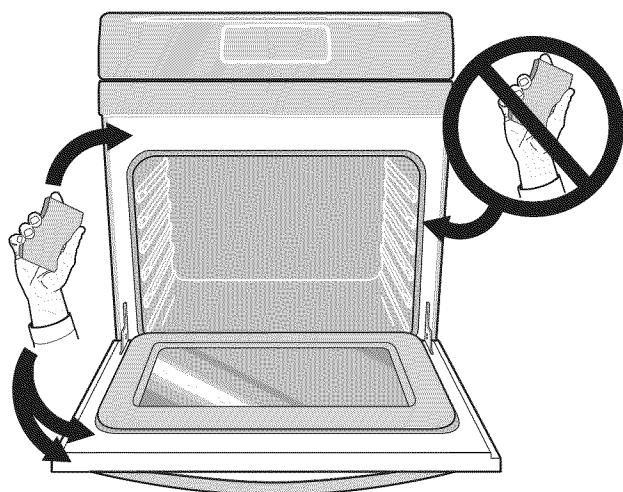



Figure 28: Oven door area to clean and not clean (gasket).

Important note:

Completely remove all oven racks and any accessories from oven cavity to avoid damage to oven racks. If the oven racks are not removed they may discolor.

- Remove all items from the oven including bakeware, utensils and any aluminum foil. Aluminum foil will not withstand high temperatures from a self clean cycle and will melt.
- Do not use oven cleaners or oven protective coatings in or around any part of the oven interior.
- Clean any soil from the oven frame, the door liner outside the oven door gasket and the small area at the front center of the oven bottom (Figure 28). These areas heat sufficiently to burn soil on. Clean using soap and water prior to starting Self Clean.
- Do not clean the oven door gasket (Figure 28). The woven material of the oven door gasket is essential for a good seal. Care should be taken not to rub, damage or remove the gasket. Do not use any cleaning materials on the oven door gasket. Doing so could cause damage to the door gasket.
- Remove any excessive build up caused by spills. Any spill on the oven bottom should be wiped up and removed before starting a self clean cycle. To clean, use hot, soapy water and a cloth. Large spill residue can cause heavy smoke or fire when subjected to high temperatures. Do not allow food spills with a high sugar or acid content (such as milk, tomatoes, sauerkraut, fruit juices or pie filling) to remain on the surface as they may leave a dull spot even after cleaning.
- This model comes with lubricated porcelain oven racks, which can remain in the oven during the self-clean cycle. Do not clean this vegetable oil lubrication off the racks. It is important that the sides of the oven racks always have a light coating of vegetable oil. To maintain optimal rack performance, re-apply a thin layer of vegetable oil to the sides of the rack after every self-clean cycle or when the rack becomes difficult to slide.

To set self clean:

1. Be sure the oven is empty. Removing oven racks is recommended.
2. Press **Upper Oven** or **Lower Oven**.
3. Press **Self Clean** and the default 3 hour clean time will appear in the display. You may accept the default 3 hour clean time by going to step 4. If a 2 or 4 hour clean time is desired, press **2 0 0** for 2 hour or **4 0 0** for a 4 hour clean time..
4. Press  to activate Self Clean.

Oven Controls

5. As soon as Self Clean becomes active, a motor driven lock mechanism will begin locking the oven door automatically and **DOOR** and **LOCKED** will appear in the display. Do not open the oven door when **DOOR** and **LOCKED** are displayed (allow 15 seconds for the lock mechanism to lock the oven). Once the oven door has locked, **CLn** will appear in the display indicating Self Clean has started.

When Self Clean is finished:

⚠ CAUTION Use caution when opening the oven door after self cleaning. The oven may still be very hot and can cause burns. To avoid possible burns stand to the side of the oven when opening the oven door to allow hot air or steam to escape.

⚠ CAUTION The oven bake and broil elements may appear to have cooled after they have been turned off. The elements may still be hot and burns may occur if these elements are touched before they have cooled.

1. **CLn** message will turn off, and **Hot** will appear in display window.
2. When **DOOR** and **LOCKED** disappear from the display, the oven may be opened.
3. When the oven interior has completely cooled, wipe away any residue or powdered ash with a damp cloth or paper towel.

Important note:

The kitchen area should be well ventilated. Use an open window, ventilation fan or exhaust hood during the first self clean cycle to help eliminate the normal odors associated with the 1st self clean cycle.

When the clean time finishes the oven door will remain locked until the oven has cooled sufficiently. In addition to the clean time that was programmed, allow about 1 additional hour for the oven to cool before opening the oven door. The Self Clean function will not operate when the oven lockout is active.

Setting Delay Start Self Clean.

To start a delay Self Clean with default clean time of 3 hours and a start time of 9:00 o'clock:

1. Be sure the clock is set with the correct time of day, the oven is empty and ALL oven racks are removed. Be sure oven door is completely closed.
2. Press **Self Clean**.
3. Press **Delay Start**.
4. Using numeric keys enter **9 0 0** for time to start.
5. Press .

If it becomes necessary to stop Self Clean when active:

1. Press . **DOOR** and **LOCKED** will flash.
2. If Self Clean has heated the oven to a high temperature, allow enough time for the oven to cool. When **DOOR** and **LOCKED** disappear from the display, the oven may be opened.
3. Before restarting Self Clean, be sure to read important notes below.

Important note:

- When Self Clean is active you may check the amount of clean time remaining by pressing the Self Clean key once.
- If your clock is set with the (default) 12 hr display mode, the Delay Start for a Self Clean can only be programmed to start up to 11 hours and 59 minutes after the time showing in the display (be sure to set the clock to current time before programming a delay start). To set a Delay Start Self Clean to begin 12 or more hours (maximum is 23 hours and 59 minutes) after the time of setting, be sure to first set the control in the 24 Hr display mode.
- If Self Clean was active and then interrupted by a power failure or cancelled before the oven was thoroughly cleaned, it may be necessary to run another Self Clean cycle.
- If the oven temperature was high enough when Self Clean was interrupted the oven control may not allow another Self Clean cycle to be set for up to 4 hours.

Care and Cleaning

Cleaning Various Parts of Your Oven

Before cleaning any part of the oven, be sure all controls are turned off and the oven is cool. Remove spills and any heavy soiling as soon as possible. Regular cleaning will reduce the difficulty and time of major cleaning later.

Surface Type	Recommendation
Painted body parts Painted decorative trim Aluminum, plastic, or vinyl trim	For general cleaning, use hot soapy water and a cloth. Dry with a clean cloth. For more difficult soils and build-up grease, use a soft cloth and clean with mild dish detergent and water or a 50/50 solution of vinegar and water. Follow by rinsing the area with clean water; dry and polish with a soft cloth. Glass cleaners may be used if sprayed on a soft cloth first. Do not spray liquids directly on the oven control and display area. Do not use large amounts of water on the control panel. Excess water on the control area may cause damage to the appliance. Do not use other liquid cleaners, abrasive cleaners, scouring pads, or paper towels. They will damage the finish.
Control panel Control keypad membrane	Before cleaning the control panel, turn all controls off and activate oven lockout (on some models). Do not use abrasive cleaners on any of these materials; they can scratch. Clean using hot, soapy water and a cloth or sponge. Be sure to squeeze excess water from cloth or sponge before wiping control panel, especially when wiping around the controls area. Excess water in or around the controls may cause damage to the appliance.
Porcelain enamel parts and door liner	Gentle scrubbing with a soapy non-abrasive scouring pad will remove most spots. Rinse with a 1:1 solution of clear water and ammonia. If necessary, cover difficult spots with an ammonia-soaked paper towel for 30 to 40 minutes. Rinse with clean water and a damp cloth, and then scrub with a soap-filled non-abrasive scouring pad. Rinse and wipe dry with a clean cloth. Do not allow food spills with high sugar or acid content (milk, tomatoes, sauerkraut, fruit juices, or pie filling) to remain on the surface; they may cause a dull spot even after cleaning.
Oven interior	Remove excessive spillovers from oven cavity bottom before starting Self Clean. Clean any soils from oven frame and door liner outside the oven door gasket. For very important cleaning precautions, be sure to read all the instructions on "Self Clean" on page 25.
Porcelain coated oven racks	This model comes with lubricated porcelain oven racks, which can remain in the oven during the self-clean cycle. Do not clean this vegetable oil lubrication off the racks. It is important that the sides of the oven racks always have a light coating of vegetable oil. To maintain optimal rack performance, re-apply a thin layer of vegetable oil to the sides of the rack after every self-clean cycle or when the rack becomes difficult to slide.
Oven door	Use soap and water to thoroughly clean the top, sides, and front of the oven door. Rinse well. You may use a glass cleaner on the outside glass of the oven door. Do not immerse the door in water. Do not spray or allow water or the glass cleaner to enter the door vents. Do not use oven cleaners, cleaning powders, or any harsh abrasive cleaning materials on the outside of the oven door. The oven gasket located on the frame and visible when the door is opened is essential for a good seal. Do not clean the oven door gasket. On some models, the oven door gasket is made of a woven material. Care should be taken not to rub, damage, or remove this gasket.
Stainless Steel (some models)	Always rub in direction of metal grain to avoid damaging. Do not use cleaners with high concentrations of chlorides or chlorine. Do not use harsh scrubbing cleaners. Polish with a lint-free cloth. Always be sure to wipe excess cleaner/polish off from the metal surface as bluish stains may occur during future oven heating that cannot be removed. Clean heavier soils with hot, soapy water and a cloth or sponge. Rinse and dry using clean water and a cloth.

Caring for Your Porcelain Enameled Glide Racks

⚠ CAUTION Handle oven racks only when they are cool. After cooking or after the self clean cycle, racks will be very hot and can cause burns.

Important Notes:

- It is recommended to remove all racks from the oven during self clean cycles, but porcelain racks may be left in the oven if they are soiled. After a self clean cycle, or anytime the gliding is rough, the glide racks should be treated with graphite lubrication.
- Do not use cooking oil, cooking spray, or other oil-based lubrication products on the glide rack extension tracks. Use only the graphite lubrication in this area. To order graphite lubrication, contact your installer, servicer or dealer.
- It is important that the parts of the rack that contact the oven sides always have a light coating of vegetable oil. Apply a thin layer of vegetable oil to the sides of the rack after every self clean cycle and when the rack becomes difficult to reposition in the oven.

To lubricate the glide rack:

1. Remove the rack from the oven and place the rack on a large flat surface covered with newspaper or scrap cloth. Fully extend the rack.
2. Wipe away debris and crumbs from the glide track using a cloth or sponge.

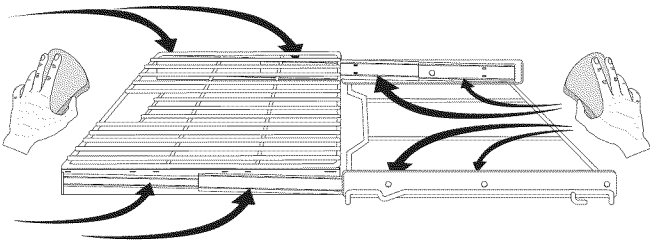

3. Shake graphite lubrication very well before applying. Place four drops of graphite lubrication along the tracks (see area circled on figure below). Repeat on both sides of the glide rack.

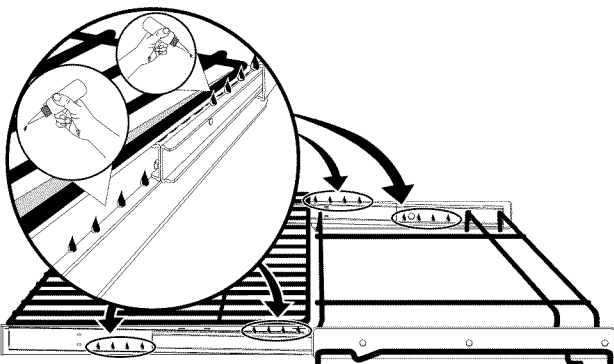

4. Extend and return the glide rack several times along the tracks to distribute the lubrication.

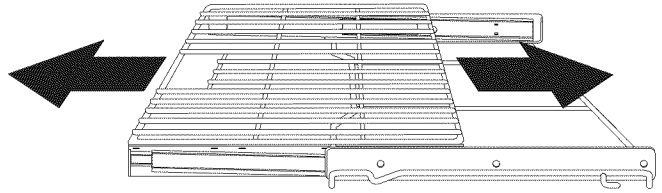

5. Turn glide rack over. Shake graphite lubrication very well before applying. Place four drops of graphite lubrication along the tracks. Repeat on both sides of the glide rack.

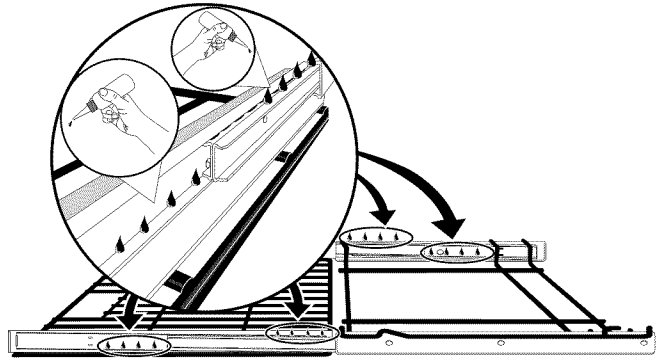

6. Extend and return the glide rack several times along the tracks to distribute the lubrication.

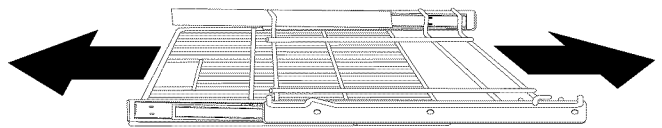

7. Apply a thin layer of cooking oil to the outer frame of the glide rack as shown below. Keeping the frame sides lightly lubricated allows the entire rack to slide easily when changing rack positions.

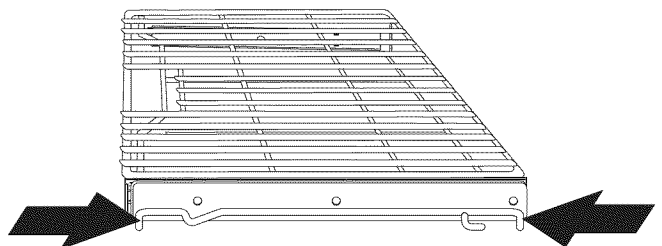

8. Replace rack in oven right-side up.

Replacing the Oven Light

⚠ CAUTION Be sure the oven is unplugged and all parts are cool before replacing oven light. Wear a leather-faced glove for protection against possible broken glass.

The interior oven lights are located at the rear of the oven cavity and are covered with a glass shield. The glass shield must be in place whenever the oven is in use (Figure 29).

To replace the oven interior light bulb:

1. Turn electrical power off at the main source.
2. Remove interior oven light shield by turning a quarter turn counter-clockwise.
3. Replace bulb with a new T-4 type Halogen 25 watt appliance bulb.

Important note:

Do not allow your fingers to touch the new bulb when replacing. This will shorten the life of the bulb. Use a paper towel or cotton glove while handling the new bulb when installing.

4. Replace glass oven light shield by rotating clockwise.
5. Turn power back on again at the main source (or plug the appliance back in).
6. Be sure to reset the time of day on the clock.

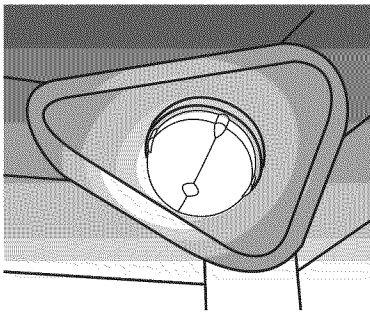

Figure 29: Wall oven Halogen light

General Cleaning

Refer to “Cleaning Various Parts of Your Oven” on page 27 for more detailed information about cleaning specific parts of your oven.

⚠ CAUTION Before manually cleaning any part of the oven, be sure all controls are off and the oven is cool. The oven may be hot and can cause burns.

⚠ CAUTION Ammonia must be rinsed before operating the oven. Provide adequate ventilation.

Aluminum Foil and Oven Liners

⚠ WARNING Never cover any slots, holes, or passages in the oven bottom or cover an entire oven rack with materials such as aluminum foil. Aluminum foil linings may trap heat, causing a fire hazard.

⚠ WARNING Protective Liners--Do not use aluminum foil to line the oven bottom. Only use aluminum foil as recommended in this manual. Improper installation of these liners may result in risk of electric shock or fire.

Using a liner in the oven restricts the heat and air flow needed to obtain the best possible results for any oven.

During Self Clean, the oven temperature can become hot enough to melt aluminum cooking utensils or aluminum foil if left in the oven. This could result in permanent damage to the oven interior and porcelain finish.

Removing and Replacing the Oven Door

⚠ CAUTION The door is heavy. For safe, temporary storage, lay the door flat with the inside of the door facing down.

⚠ CAUTION To prevent possible burns, do not attempt to remove the oven door until the oven has completely cooled.

To remove the oven door:

1. Open oven door completely, horizontal with floor.
2. Pull up the lock located on each hinge support toward front of the oven. You may have to apply a little upward pressure on the lock to pull it up (Figure 31 and Figure 32).
3. Grasp the door by the sides, pull the bottom of the door up and toward you to disengage the hinge supports.
4. Keep pulling the bottom of the door toward you while rotating the top of the door toward the appliance to completely disengage the hinge levers (Figure 33).

To Replace Oven Door:

1. Firmly grasp both sides of oven door along the door sides. Do not use the oven door handle (Figure 33).
2. Holding the oven door at the same angle as the removal position, seat the hook of the hinge arm over the roller pins located on each side of the oven door frame (Figure 33). The hook of the hinge arms must be fully seated onto the roller pins.
3. Fully open the oven door, horizontal with floor (Figure 30).
4. Push the door hinge locks up toward and into the oven frame on both left and right oven door hinges to the locked position (Figure 31).
5. Close the oven door.

Important:

Special Door Care Instructions - Most oven doors contain glass that can break. Do not close the oven door until all the oven racks are fully in place. Do not hit the glass with pots, pans, or any other object. Scratching, hitting, jarring, or stressing the glass may weaken its structure causing an increased risk of breakage at a later time.

Important note:

These instructions are for soft close hinge models.

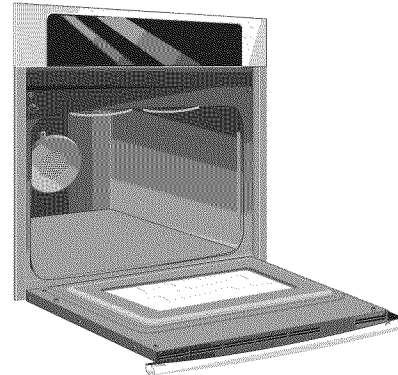

Figure 30: Door at horizontal position

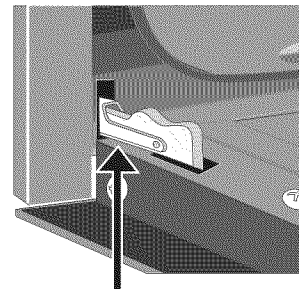

Figure 31: Door hinge locks

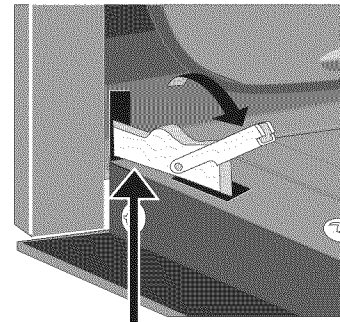

Figure 32: Hinge: unlocked position

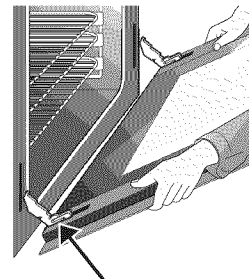

Figure 33: Holding door for removal

Before You Call

Oven Baking

For best cooking results, heat the oven before baking cookies, breads, cakes, pies or pastries, etc. There is no need to preheat the oven for roasting meat or baking casseroles.

The cooking times and temperatures needed to bake a product may vary slightly from your previously owned appliance.

Baking Problems and Solutions

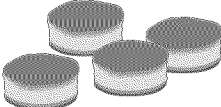
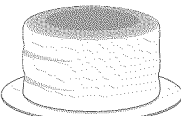
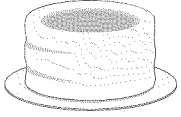
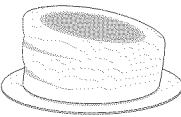
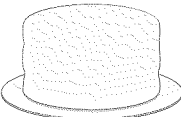
Baking Problems	Causes	Corrections
<p>Cookies and biscuits burn on the bottom.</p> 	<ul style="list-style-type: none"> • Cookies and biscuits put into oven before the preheating time is completed. • Oven rack is overcrowded. • Dark pans absorb heat too fast. 	<ul style="list-style-type: none"> • Allow oven to preheat to desired temperature before placing food in oven. • Choose pan sizes that will permit 2" to 4" of air space (5.1 cm or 10.2 cm) on all sides when placed in the oven. • Use a medium weight baking sheet.
<p>Cakes too dark on top or bottom</p> 	<ul style="list-style-type: none"> • Cakes put in oven before preheating time is completed. • Rack position too high or too low. • Oven too hot. 	<ul style="list-style-type: none"> • Allow oven to preheat to the selected temperature before placing food in the oven. • Use proper rack position for baking needs. • Set oven temperature 25°F (12°C) lower than recommended.
<p>Cakes not done in center</p> 	<ul style="list-style-type: none"> • Oven too hot. • Incorrect pan size. • Pan not centered in oven. 	<ul style="list-style-type: none"> • Set oven temperature 25°F (12°C) lower than recommended. • Use pan size suggested in recipe. • Use proper rack position and place pan so there is 5.1 cm to 10.2 cm (2" to 4") of space on all sides of pan.
<p>Cakes not level.</p> 	<ul style="list-style-type: none"> • Oven not level. • Pan too close to oven wall or rack overcrowded. • Pan warped. 	<ul style="list-style-type: none"> • Place a marked glass measuring cup filled with water on the center of the oven rack. If the water level is uneven, refer to the installation instructions for leveling the oven. • Be sure to allow 5.1 cm to 10.2 cm (2" to 4") of clearance on all sides of each pan in the oven. • Do not use pans that are dented or warped.
<p>Foods not done when cooking time is over.</p> 	<ul style="list-style-type: none"> • Oven too cool. • Oven overcrowded. • Oven door opened too frequently. 	<ul style="list-style-type: none"> • Set oven temperature 25°F (12°C) higher than suggested and bake for the recommended time. • Be sure to remove all pans from the oven except the ones to be used for baking. • Open oven door only after shortest recommended baking time.

Solutions to Common Problems

Before you call for service, review the following list. It may save you time and expense. Possible solutions are provided with the problem listed:

Problem	Solution
Poor baking results	<ul style="list-style-type: none">• Many factors effect baking results. Use proper oven rack position. Center food in the oven and space pans to allow air to circulate. Bakeware may be too lightweight or warped. Use heavier quality bakeware so foods being prepared may bake more evenly. Preheat oven to the set temperature before placing food in the oven. Try adjusting the recipe's recommended temperature or baking time. See "Adjusting Oven Temperatures" on page 22 if you feel the oven is too hot or cold.
Oven does not operate.	<ul style="list-style-type: none">• The time of day is not set. The oven clock must first be set in order to operate the oven.• Be sure oven controls are set properly. See "Setting The Clock" on page 10 and review instructions for the desired cooking function in this manual.• Service wiring is not complete. Contact your dealer, installing agent, or authorized servicer.• Power outage. Check house lights to be sure. Call your local electric company.• Short in cord/plug. Contact your dealer, installing agent, or authorized servicer to replace cord/plug.• House fuse has blown or circuit breaker has tripped immediately following installation. House fuse may not be fully engaged. Check fuse and screw or engage circuit breaker securely.
Oven light does not work.	<ul style="list-style-type: none">• Be sure the oven light is secure in the socket. See "Replacing the Oven Light" on page 29.
Flames inside oven or smoking from oven vent.	<ul style="list-style-type: none">• Excessive spills in oven. Grease or food spilled onto oven bottom or oven cavity. Wipe up excessive spills before starting oven. If flames or excessive smoke are present when using broil, see "Setting Broil" on page 15.
Self clean does not work.	<ul style="list-style-type: none">• Oven control not set properly. Make sure the oven door is closed. Make sure you have removed the oven racks and the oven rack supports from the oven. Review "Self Clean" on page 25.
Oven racks discolored or do not slide easily.	<ul style="list-style-type: none">• Oven racks left in oven cavity during self clean. Always remove oven racks from oven cavity before starting a self-clean cycle. Clean using a mild abrasive cleaner following manufacturer's instructions. Rinse with clean water, dry, and replace in oven.
Oven smokes excessively when broiling.	<ul style="list-style-type: none">• Incorrect setting. Follow broiling instructions in the "Setting Broil" on page 15.• Meat too close to the broil element. Reposition broil rack to provide proper clearance between the meat and broil element. Remove excess fat from meat. Cut remaining fatty edges to prevent curling.• Grease build up on oven surfaces. Regular cleaning is necessary when broiling frequently. Grease or food splatters will cause excessive smoking.• Insert on broiler pan wrong side up. Grease does not drain into broiler pan. Always place the insert on the broiler pan with the ribs up and the slots down to allow grease to drip into the pan.• Broiler pan used without insert or insert cover with aluminum foil. Do not use the broiler pan without the insert or cover the insert with aluminum foil.
Convection fan does not rotate	<ul style="list-style-type: none">• Oven door is open. Convection fan will turn off if oven door is opened when convection is active. Close oven door.

<p>Oven control panel beeps and displays any F or E code error.</p>	<ul style="list-style-type: none"> • Oven control has detected a fault or error condition. Press STOP/CLEAR to clear the error code. Try bake or broil function. If the F or E code error repeats, turn off power to appliance, wait 5 minutes and then repower appliance. Set clock with correct time of day. Try bake or broil function again. If fault recurs, press STOP to clear.
<p>Soil not completely removed after self clean.</p>	<ul style="list-style-type: none"> • Self Clean was interrupted. Review “Self Clean” on page 25. • Excessive spills on oven bottom. Clean before starting self clean. • Failure to clean soil from the oven frame, the door liner outside the oven door gasket, and the small area at the front center of the oven bottom. These areas are not in the self-cleaning area, but they get hot enough to burn on residue. Clean these areas before starting the self-cleaning cycle. Burned-on residue can be cleaned with a stiff nylon brush and water or a nylon scrubber. Be careful not to damage the oven gasket.
<p>Appliance is not level.</p>	<ul style="list-style-type: none"> • Poor installation. Place oven rack in center of oven. Place a level on the oven rack. • Kitchen cabinet alignment may make oven appear not level. Be sure cabinets are square and have sufficient room for appliance clearance. • Cabinets not square or are built in too tightly. Contact builder or installer to make appliance accessible.
<p>Fan noise occurring after the oven is turned off.</p>	<ul style="list-style-type: none"> • Some models are equipped with a cooling fan that runs during the cooking process to cool internal electronic components. It is normal for this fan to continue to run for an extended period of time, even when the oven is off.



Before You Call

Master Protection Agreements

Congratulations on making a smart purchase. Your new Kenmore® product is designed and manufactured for years of dependable operation. But like all products, it may require preventive maintenance or repair from time to time. That's when having a Master Protection Agreement can save you money and aggravation.

The Master Protection Agreement also helps extend the life of your new product. Here's what the Agreement* includes:

- ☑ **Parts and labor** needed to help keep products operating properly **under normal use**, not just defects. Our coverage goes **well beyond the product warranty**. No deductibles, no functional failure excluded from coverage – **real protection**.
- ☑ **Expert service** by a force of more than **10,000 authorized Sears service technicians**, which means someone you can trust will be working on your product.
- ☑ **Unlimited service calls and nationwide service**, as often as you want us, whenever you want us.
- ☑ **"No-lemon" guarantee** – replacement of your covered product if four or more product failures occur within twelve months.
- ☑ **Product replacement** if your covered product can't be fixed.
- ☑ **Annual Preventive Maintenance Check** at your request – no extra charge.
- ☑ **Fast help by phone** – we call it **Rapid Resolution** – phone support from a Sears representative on all products. Think of us as a "talking owner's manual".
- ☑ **Power surge protection** against electrical damage due to power fluctuations.
- ☑ **\$250 Food Loss Protection** annually for any food spoilage that is the result of mechanical failure of any covered refrigerator or freezer.
- ☑ **Rental reimbursement** if repair of your covered product takes longer than promised.
- ☑ **25% discount** off the regular price of any non-covered repair service and related installed parts.

Once you purchase the Agreement, a simple phone call is all that it takes for you to schedule service. You can call anytime day or night, or schedule a service appointment online.

The Master Protection Agreement is a risk free purchase. If you cancel for any reason during the product warranty period, we will provide a full refund. Or, a prorated refund anytime after the product warranty period expires. Purchase your Master Protection Agreement today!

Some limitations and exclusions apply. For prices and additional information in the U.S.A. call 1-800-827-6655.

*** Coverage in Canada varies on some items. For full details call Sears Canada at 1-800-361-6665.**

Sears Installation Service

For Sears professional installation of home appliances, garage door openers, water heaters, and other major home items, in the U.S.A. or Canada call 1-800-4-MY-HOME®.

Acuerdos maestros de protección

Enhorabuena por haber hecho una compra inteligente. Su nuevo producto Kenmore® está diseñado y fabricado para brindarle años de funcionamiento fiable. Pero, como cualquier producto, puede necesitar mantenimiento preventivo o reparaciones periódicas. Es por eso que tener un Acuerdo maestro de protección podría ahorrarle dinero y molestias.

El Acuerdo maestro de protección también sirve para prolongar la durabilidad de su nuevo producto. El acuerdo* incluye lo siguiente:

- ☑ **Piezas y mano de obra** necesarias para contribuir a mantener el funcionamiento adecuado de los productos **utilizados en condiciones normales de uso**, no sólo en caso de defectos de los productos. Nuestra cobertura va **mucho más allá que la garantía del producto**. No se aplican deducibles ni exclusiones por fallas del funcionamiento: es decir, **verdadera protección**.
- ☑ **Servicio técnico por expertos** (más de **10000 técnicos autorizados de Sears**), lo cual significa que quien repare o realice el mantenimiento de su producto será un profesional de confianza.
- ☑ **Servicio técnico a escala nacional y número ilimitado de llamadas de solicitud de servicio técnico**: se puede poner en contacto con nosotros cuantas veces lo desee y cuando lo desee.
- ☑ **Garantía "sin sorpresas"**: se reemplaza el producto cubierto por el acuerdo si ocurren cuatro o más fallas del producto en un periodo de 12 meses.
- ☑ **Reemplazo del producto**: en caso de que no se pueda reparar el producto cubierto por el acuerdo.
- ☑ **Revisión anual preventiva de mantenimiento del producto**: puede solicitarla en cualquier momento, sin costo alguno.
- ☑ **Rápida asistencia telefónica**, la cual denominamos **Solución rápida**: es decir, asistencia telefónica a través de cualquiera de nuestros representantes de Sears, sobre cualquiera de nuestros productos. Piense en nosotros como en un "manual parlante del usuario".
- ☑ **Protección contra fallas eléctricas**, contra daños debidos a fluctuaciones de la corriente eléctrica.
- ☑ **\$250 al año para cubrir cualquier posible deterioro de alimentos** que haya tenido que desechar debido a una falla mecánica de cualquiera de nuestros refrigeradores o congeladores cubiertos por este acuerdo.
- ☑ **Devolución de gastos de alquiler de electrodomésticos** si la reparación de su producto asegurado toma más que el tiempo prometido.
- ☑ **25% de descuento** aplicable tanto a los costos del servicio de reparación, como de las piezas instaladas relacionadas que no hayan quedado cubiertos por este acuerdo.

Una vez que haya realizado el pago de este acuerdo, bastará una simple llamada telefónica para concertar una visita de servicio. Puede llamar a cualquier hora del día o de la noche, o bien concertar una visita de servicio por Internet.

La adquisición del Acuerdo maestro de protección es una inversión exenta de riesgos. Si por cualquier motivo decide cancelar dicho acuerdo durante el periodo de garantía del producto, le haremos un reintegro total del valor. O bien un importe proporcional si cancela el acuerdo en cualquier otro momento posterior al vencimiento del periodo de garantía del producto. ¡Adquiera hoy mismo su Acuerdo maestro de protección!

Algunas limitaciones y exclusiones podrían aplicarse. Para solicitar precios e información adicional, llame al 1-800-827-6655 (en los EE.UU.).

*** La cobertura en Canadá varía en el caso de algunos artículos. Para obtener detalles completos al respecto, llame al 1-800-361-6665 de Sears de Canadá.**

Servicio de instalación de Sears

Para solicitar la instalación por profesionales de Sears de electrodomésticos, abridores de puertas de garaje, calentadores de agua y otros artículos de uso prioritario en el hogar, llame al 1-800-4-MY-HOME en los EE.UU. o Canadá.

Get it fixed, at your home or ours!

Your Home

For troubleshooting, product manuals and expert advice:



www.managemylife.com

For repair – **in your home** – of **all** major brand appliances, lawn and garden equipment, or heating and cooling systems, **no matter who made it, no matter who sold it!**

For the replacement parts, accessories and owner's manuals that you need to do-it-yourself.

For Sears professional installation of home appliances and items like garage door openers and water heaters.

1-800-4-MY-HOME[®] (1-800-469-4663)

Call anytime, day or night (U.S.A. and Canada)

www.sears.com www.sears.ca

Our Home

For repair of carry-in items like vacuums, lawn equipment, and electronics, call anytime for the location of your nearest

Sears Parts & Repair Service Center

1-800-488-1222 (U.S.A.) **1-800-469-4663** (Canada)

www.sears.com www.sears.ca

To purchase a protection agreement on a product serviced by Sears:

1-800-827-6655 (U.S.A.) **1-800-361-6665** (Canada)

Para pedir servicio de reparación a domicilio, y para ordenar piezas:

1-888-SU-HOGAR[®]

(1-888-784-6427)

www.sears.com

Au Canada pour service en français:

1-800-LE-FOYER^{MC}

(1-800-533-6937)

www.sears.ca

sears

[®] Registered Trademark / [™] Trademark of KCD IP, LLC in the United States, or Sears Brands, LLC in other countries

© Marca Registrada / [™] Marca de Fábrica de KCD IP, LLC en Estados Unidos, o Sears Brands, LLC in otros países

^{MC} Marque de commerce / ^{MD} Marque déposée de Sears Brands, LLC