

HYUNDAI
POWER PRODUCTS

DC INVERTER TIG WELDER HYTIG160 & HYTIG200

Instruction Manual



GENUINE PRODUCT OF
HYUNDAI CORPORATION



WARNING: Read the instructions carefully before use.



TIG-160/200

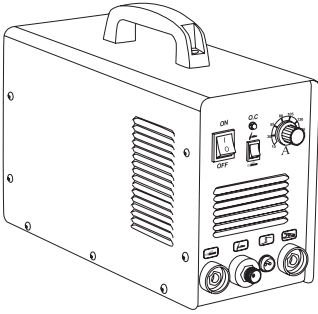

We are still constantly improving this welder, therefore, some parts of this welder may be changed in order to achieve the better quality, but the main functions and operations will not be alternated and changed.

Your understanding would be greatly appreciated.

Table of Contents

Safety	2
General Description	4
Main Parameters	4
Operation Control and Description	5
Installation Debugging and Operation	6
Caution	7
Maintenance	8
Troubleshooting	9
Exploded Drawing	11

1. Safety

Welding is dangerous, and may cause damage to you and others, so take good protection when welding. For details, please refer to the operator safety guidelines in conformity with the accident prevention requirements of the manufacturer.



Professional training is needed before operating the machine.

- Use labor protection welding supplies authorized by national security supervision department.
- The operator must be qualified personnel with a valid “metal welding (OFC) operations” operation certificate.
- Cut off power before maintenance or repair.

Electric shock—may lead to serious injury or even death.

- Install earth device according to the application criteria.
- Never touch the live parts when skin bore or wearing wet gloves/clothes.
- Make sure that you are insulated from the ground and work piece.
- Make sure that your working position is safe.

Smoke& gas—may be harmful to health.

- Keep the head away from smoke and gas to avoid inhalation of exhaust gas from welding.
- Keep the working environment in good ventilation with exhaust or ventilation equipment when welding.

Arc radiation—may damage eyes or burn skin.

- Wear suitable welding masks and protective clothing to protect your eyes and body.
- Use suitable masks or screens to protect spectators from harm.

Improper operation may cause fire or explosion.

- Welding sparks may result in a fire, so please make sure no combustible materials nearby and pay attention to fire hazard.
- Have a fire extinguisher nearby, and have a trained person to use it.
- Airtight container welding is forbidden
- Must not use the machines for other purposes except welding, such as pipe thawing, battery charging, heating.



Hot work piece may cause severe scalding.

- Do not contact hot work piece with bare hands.
- Cooling is needed during continuous use of the welding torch.

Magnetic fields affect cardiac pacemaker.

- Pacemaker users should be away from the welding spot before medical consultation.

Moving parts may lead to personal injury.

- Keep yourself away from moving parts such as fan.
- All doors, panels, covers and other protective devices should be closed during operation.

Please seek professional help when encountering machine failure.

- Consult the relevant contents of this manual if you encounter any difficulties in installation and operation.
- Contact the service center of your supplier to seek professional help if you still cannot fully understand after reading the manual or still cannot solve the problem according to the manual.

Safe use of the welding torch.

- Parts of the machine, such as the end of the filler wire and welding torch become burning hot during use. The wire is also sharp and moves quickly, so be careful when threading it to place.
- Never carry the machine on your shoulder during welding, but place it on an even surface. Also, do not store the machine by hanging it from the shoulder strap. The shoulder strap is for carrying only.
- Do not keep the machine near or on hot objects, as the plastic cover may melt.
- Do not move the shielding gas bottle when the control valve is in place. Fix the gas bottle securely in an upright position to a separate wall rack or bottle cart.
- Always close the gas bottle after use.

2. General Description

The welding machine has the most advanced inverter technology adopting rectifier.

The development of inverter gas-shielded welding equipment profits from the development of the inverter power supply theory and components. Inverter gas-shielded welding power source utilizes high-power component MOSFET to transfer 50/60Hz frequency up to 100KHz, then reduce the voltage and commutate, and output high-power voltage via PWM technology. Because of great reduction of main transformer's weight and volume; the efficiency increases by 30%. Its transfer efficiency is above 85%. The appearance of inverter welding equipment is considered to be a revolution for welding industry.

Welding power source can offer stronger, more concentrated and more stable arc. When stick and work piece get short, its response will be quicker. It means that it is easier to design welding machine with different dynamic characteristics, and it can even be adjusted specially to make arc softer and also harder.

TIG welding machine is easy for arc initiation and has the functions of arc initiation current, arc stop current, welding current, basic value current, current ascending time, current descending time, gas delay time, continuous adjustment. What's more, pulse frequency and pulse duty can also be adjusted independently. It has the characteristics of automatic control of arc initiation, arc stop and stable arc, which make the best result for shape and inner quality of the welding surface.

The machine can be for multi-use, and can weld stainless steel, carbon steel, copper and other color metal, and also can use for traditional electric welding.

3. Main Parameters

Model	TIG-160		TIG-200	
Rated Input Voltage (V)	1P AC 230V, 50Hz			
Rated Input Current (A)	15		20	
Output Current (A)	TIG 10-160	MMA 10-140	TIG 10-200	MMA 10-160
Rated Output Voltage (V)	16.4	25.6	18	26.4
No-load Voltage (V)	56		56	
Rated Duty Cycle (%)	60		60	
Efficiency (%)	85		85	
Protection Class	IP21S		IP21S	
Insulation Class	F		F	
Arc Starting	HF		HF	
No-load Loss (W)	35		35	

4. Operation Control and Description

The panel picture below is for reference only. If any difference with the real machine, please follow with the real machine.

TIG Welding Description

- 1) Turn on the power switch at the back panel, digital current meter is normal, fan begins to wheel.
- 2) Open the valve of argon cylinder, adjust the volume of flow meter and make it is adequate to welding.
- 3) Press switch of torch, electromagnetic valve is started. Sound of HF arc striking can be heard, at the same time argon is flowing from torch burner.

Notes

When welding is first operated, user must press switch of torch for several seconds and begin to weld until all of air is be drained out. When welding is over, argon will still flow out in several seconds in order to protect welding spot before cooling down. So torch must be kept onto welding place for some time before arc has been extinguished.

- 4) Set suitable welding current and make sure welding current is adequate to thickness of work piece and process demand.
- 5) It is 2-4 mm from welding tungsten electrode to work piece, press control knob of torch, burn and strike arc, sound of HF arc-striking will be diminished. The welding machine can be operated now.

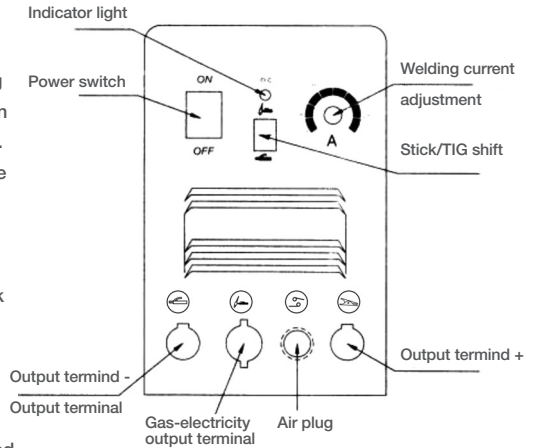

Stick Welding Description

- 1) Open power switch of front panel, fan is beginning to work.
- 2) Make sure function switch of front panel is "down" position that is sticking. Impulse changeover switch and knob of current down-slope time will not work.
3. Make sure welding current is adequate to thickness of work piece.

Warning

During welding, it is forbidden to pull off any plug or cable in use, or it will lead to life-threatening danger and severe damage to the machine.

5. Installation Debugging and Operation

The machine is equipped with power voltage compensation equipment. When power voltage moves between $\pm 15\%$ of rated voltage, it still can work normally.

When using long cable, in order to prevent voltage from going down, bigger section cable is suggested. If cable is too long, it may affect the performance of the power system. So we suggest you to use configured length.

- 1) Make sure intake of the machine not blocked or covered, lest cooling system could not work.
- 2) Make good connection of shielded gas source. Gas supply passage includes cylinder, argon decompress flow meter and pipe. Connecting part of pipe should use hoop or other things to fasten, lest argon leaks out and air gets in.
- 3) Use inducting cable whose section is not less than 6 mm² to connect the housing to the ground. The way is from the ground-connecting screw at the back to the earth device.
- 4) Correctly connect the arc torch or holder according to the picture. When using MMA welding: Make sure the cable, holder and fastening plug have been connected with the ground. Put the fastening plug into the fastening socket at the “-” polarity and fasten it clockwise. When using pulse arc welding: Put the gas-electricity plug of the welding gun to the joint at the front panel, and fasten clockwise. Put the air switch on the gun to the relevant joint at the front panel, and fasten the screw.
- 5) Put the fastening plug of the cable to fastening socket of “+” polarity at the front panel, fasten it clockwise, and the earth clamp at the other terminal clamps the work piece.
- 6) According to input voltage grade, connect power cable with power supply box of relevant voltage grade. Make sure no mistake and make sure the voltage difference among permission range. After the above job, installment is finished and welding is available.

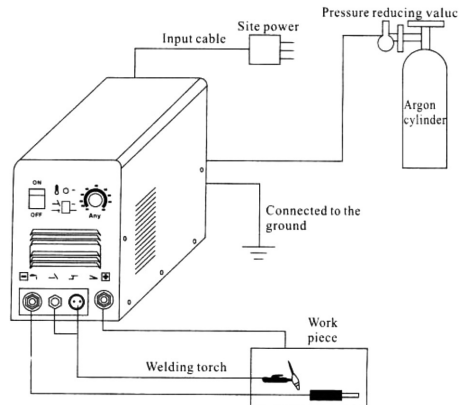

Warning

Before connecting operation, please make sure all the power is turned off. The right order is to connect the welding and ground cable to the machine first, and make sure they are firmly connected and then put the power plug to the power source.

6. Caution

Environment

- 1) The machine can perform in environment in dry condition with a dampness level of max 90%.
- 2) Ambient temperature is between 10 to 40°C.
- 3) Avoid welding in sunshine or rain.
- 4) Do not use the machine in environment where condition is polluted with conductive dust on the air or corrosiveness gas on the air
- 5) Avoid gas welding in the environment of strong airflow.

Safety norms

The welding machine is equipped with protection circuit of over voltage, current and heat. When voltage and output current and temperature of machine are exceeding the rate standard, welding machine will stop working automatically. Because it will be damage to welding machine, user must pay attention as follows.3

1) The working area is adequately ventilated!

The welding machine is powerful machine, when it is being operated, it generated high currents, and natural wind will not make machine cool enough. So there is a fan in machine to cool down machine. Make sure the intake is not in block or covered, it is 0.3 meter from welding machine to objects of environment. User should make sure the working area is adequately ventilated. It is important for the performance and the durability of the machine.

2) Do not overload!

The operator should remember to watch the max duty current (Response to the selected duty cycle).

Keep welding current from exceeding max duty cycle current. Over-load current will damage and burn up machine.

3) No over voltage!

Power voltage can be found in table of main technical data. Automatic compensation circuit of voltage will assure that welding current remain in allowable range. If power voltage exceeds limited range, it is damage to components of machine. The operator should understand the situation and take preventive measures.

4) There is a grounding screw behind welding machine and there is grounding marker on it. Mantle must be grounded reliable with cable which section is over 6 square millimeter in order to prevent from static electricity and leaking.

5) If welding time exceeds limited duty cycle, welding machine will stop working for protection. Because machine is overheated, temperature control switch is on "ON" position and the indicator light is red. In this situation, you don't have to pull the plug in order to let the fan cool the machine. When the indicator light is off, and the temperature goes down to the standard range, it can weld again. should be fully prepared for protection.

 **Caution** : Creep age-protecting switch. The machine is mainly used in industrial site. It will produce radio wave, so the worker should be fully prepared for protection. should be added when using the machine

 **Warning** : BEFORE CHECKING : Blind experiment and careless repair may lead to more problem of the machine that will make formal check and repair more difficult. When the machine is electrified, the naked parts contain life-threatening voltage. Any direct and indirect touch will cause electric shock, and severe electric shock will lead to death.

 **Caution** : The machine is mainly used in industrial site. It will produce radio wave, so the worker should be fully prepared for protection.

7. Maintenance

 **Caution** : Before Maintenance and checking, power must be turned off, and before opening the housing, make sure the power plug is pulled off.

- 1) Remove dust by dry and clean compressed air regularly, if welding machine is operating in environment where is polluted with smoke and contaminated air, the machine needs to be cleaned everyday
- 2) Pressure of compressed air must be in reasonable range in order to prevent damage to small components of machine.
- 3) Check internal circuit of welding machine regularly and the cable as well. Circuit is connected correctly and connectors are connected tightly (especially insert and connect components). If scale and loose are found, please give a good polish to them, then connect them again tightly.
- 4) Avoid water and steam enter into inter-machine. If they enter into machine, please dry the inside of machine then check insulation of machine.
- 5) If welding machine has not operated long time, it must be put into packing box and stored in dry environment.



Correct Disposal of this product

This marking indicates that this product should not be disposed with other household wastes throughout the EU. To prevent possible harm to the environment or human health from uncontrolled waste disposal, recycle it responsibly to promote the sustainable reuse of material resources. To return your used device, please use the return and collection systems or contact the retailer where the product was purchased. They can take this

8. Troubleshooting

Fittings, welding materials, environment factor, supply powers maybe have something to do with welding. User must try to improve welding environment.

A. Black welding spot

Welding spot is not protected from oxidizing. User may check as following:

1. Make sure the valve or argon cylinder open and its pressure is enough. Argon cylinder must be filled up to enough pressure again if pressure of cylinder is below 0.5Mpa.
2. Check if the flow meter opens and has enough flow. User can choose different flow according to welding current in order to save gas. But too small flow maybe cause black welding spot because preventive gas is too short to cover welding spot. We suggest that flow of argon must be kept min 5 L/min.
3. Check if torch is in block.
4. If gas circuit is not air-tight or gas is not pure, it can lower welding quality.
5. If air is flowing powerfully in welding environment, that can lower welding quality.

B. Arc-striking is difficult and easy to pause

1. Make sure quality of tungsten electrode is high.
2. Grind end of the tungsten electrode to taper. If tungsten electrode is not grinded, that will be difficult to strike arc and cause unstable arc.

C. Output current not to rated value

When power voltage departs from the rated value, it will make the output current not matched with rated value; when voltage is lower than rated value, the max output may be lower than rated value.

D. Current is not stable when machine operates

It has some factors as following:

1. Electric wire net voltage has been changed.
2. There is harmful interference from electric wire net or other equipment.

E. When use MMA welding, too much spatter

1. Maybe current is too big and stick's diameter is too small;
2. Output terminal polarity connection is wrong, it should apply the opposite polarity at the normal technics, which means that the stick should be connected with the negative polarity of power source and work piece should be connected with the positive polarity. So please change the polarity.

Common Malfunction Analysis and Solution:

Malfunction	Cause and Solution
Power indicator is not lit, fan does not work and no welding output.	<ol style="list-style-type: none"> 1. Power switch is out of work. 2. Check if electrify wire net (which is connected to input cable) is in work. 3. Check if input cable is out of circuit.
Power indicator is lit; fan does not work or revolve several circles, no welding output.	<ol style="list-style-type: none"> 1. Maybe the machine is wrongly connected to 380V power and it causes machine to be in protection circuit. Connect to 220V power and operate machine again. 2. 220V power is not stable,(input cable is too slender)or input cable is connected to electrify wire net because machine is in protection circuit. Add the section of cable and tighten input connector firmly. Close machine for 2-3 minutes then open it again. 3. Cable loosens from switch to power panel. Tighten them again. 4. Open and close power switch constantly in short time because machine is in protection circuit Close machine 2-3 minutes then open it again. <p>Main circuit 24V relay of power panel is not close or has been damaged. Check 24V power source and relay. If relay has been damaged, replace it with same model.</p>
Fan is working, indicator is not lit and sound of HF arc-striking cannot be heard, wiping welding cannot strike arc.	<ol style="list-style-type: none"> 1. Positive and negative electrodes of VH-07 insert component voltage should be about DC308V from power panel to MOS board. <ol style="list-style-type: none"> (1) If circuit is broken and silicon bridge is poorly contacted. (2) If some of four high electrolytic (about 470UF/450V) of power panel capacitor is leaking. 2. Open a green indicator in auxiliary power of MOS board, if it is not on, auxiliary power is out of work .Check fault spot and connect with seller. 3. Check if connectors are poorly contacted. 4. Check control circuit and find out reasons or connect with seller. 5. Check if control cable of torch is broken.
Abnormal indicator is not on, sound of HF arc-striking can be heard, but there is no welding output.	<ol style="list-style-type: none"> 1. Check if torch cable is broken. 2. Check if grounding cable is broken or not connected to welding piece. 3. Output terminal of positive electrode or torch electrify loosens from inter-machine.
Abnormal indicator is not lit, sound of HF arc-striking cannot be heard, wiping welding can strike arc.	<ol style="list-style-type: none"> 1. Primary cable of arc-striking transformer is not connected to power panel firmly, tighten it again. 2. Arc-striking tip is oxidized or too far, give a good polish to it or change it as about 1 mm between arc-striking tips. 3. Switch (sticking/argon-arc welding) is damaged, replace it. 4. Some of HF arc-striking circuit components are damaged. Find out and replace it.
Abnormal indicator is lit but there is no welding output.	<ol style="list-style-type: none"> 1. Maybe it is overheat protection, please close machine first, and then open the machine again after abnormal indicator is out. 2. Maybe it is overheat protection, wait for 2-3 minutes (argon-arc welding does not has overheat protection function). 3. Maybe inverter circuit is in fault, please pull up the supply power plug of main transformer which is on MOS board (VH-07 insert which is near the fan) then open the machine again. <ol style="list-style-type: none"> (1) If abnormal indicator is still lit, close machine and pull up supply power plug of HF arc-striking power source (which is near the VN-07 insert of fan), then open machine : <ol style="list-style-type: none"> a. If abnormal indicator is still lit, some of fieldistor of MOS board is damaged, find out and replace it with same model. b. If abnormal indicator is not lit, rise transformer of HF arc-striking circuit is damaged, replace it. (2) If abnormal indicator is not lit , <ol style="list-style-type: none"> a. Maybe transformer of middle board is damage, measure inductance volume and Q volume of main transformer by inductance bridge (L=0.9-1.6mH Q>35).If volume is too low, please replace it. b. Maybe secondary rectifier tube of transformer is damaged, find out faults and replace rectifier tube with same model. 4. Maybe feedback circuit is broken.
Output current is not stabilizing or out of potentiometer control and sometime is high, sometime is low.	<ol style="list-style-type: none"> 1. 1K potentiometer is damage, replace it. 2. All kinds of connectors are poor contact, specially inserts etc., please check it.
Sticking spatter is much and caustic electrode of is difficult.	Electrode is connected wrong, exchange grounding cable and handle cable.

9. Exploded Drawing

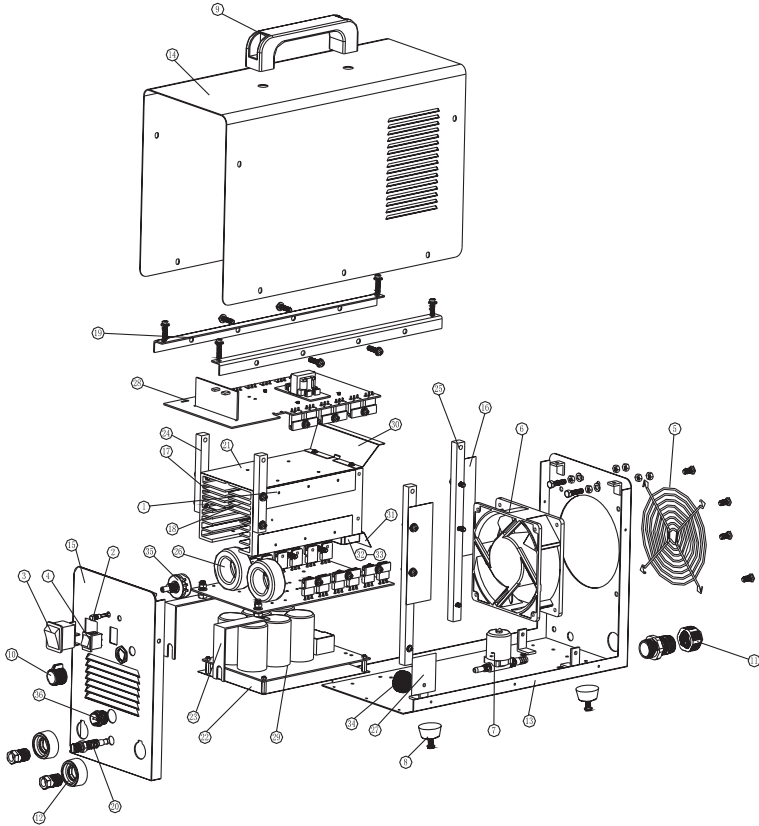

TIG-160/200

- | | | |
|---------------------------------------|------------------------------------|---------------------------|
| 1. Silicone rubber | 13. Bottom | 25. Vertical beam |
| 2. LED | 14. Cover | 26. Middle PCB |
| 3. Power switch | 15. Front panel | 27. PCB |
| 4. Switch | 16. Side shield plate | 28. Top PCB |
| 5. Fan net | 17. Radiator left | 29. Bottom PCB |
| 6. Fan net | 18. Radiator right | 30. Top shield plate |
| 7. Electromagnetically operated valve | 19. Cross beam | 31. Bottom shield plate |
| 8. Foot | 20. Gas interface | 32. Silicon bridge 11 25A |
| 9. Black handle | 21. Insulation board on top PCB | 33. Silicon bridge 14 25A |
| 10. Knob | 22. Insulation board on bottom PCB | 34. Coil |
| 11. Self-locking cable buckle | 23. Brass connector | 35. Current potentiometer |
| 12. Fast connector | 24. Vertical beam | 36. Socket |

EC Declaration of Conformity



We :

HYUNDAI Corporation
25, Yulgok-ro 2-gil, Jongno-gu, Seoul 03143 Korea

Declare that the product detailed below :

DC INVERTER TIG WELDER
MODEL : TIG-160/200

Satisfies the requirements of the Council Directives :
EC-Low voltage directive 2014/35/EU
EC Directive of Electromagnetic Compatibility 2014/30/EU
RoHS Directive 2011/65/EU

and conform with the norms :

EN 60974-1 : 2012
EN 60974-10 : 2014
IEC 62321 : 2008

General Manager

A handwritten signature in black ink, appearing to be 'J. Jeong'.

Inseok Jeong

Project Manager

A handwritten signature in black ink, appearing to be 'D. Park'.

Donghoon Park

Date : 2016.11.01

HYUNDAI

POWER PRODUCTS



GENUINE PRODUCT OF
HYUNDAI CORPORATION

For Inquiries, Please Contact:
GENPOWER LTD
Isaac Way, London Road,
Pembroke Dock, UK, SA72 4RW.
T: +44 (0) 1646 687 880
E: info@hyundaipowerproducts.co.uk
www.hyundaipowerproducts.co.uk

