

HYUNDAI
POWER PRODUCTS

ELECTRIC CLEAN WATER SUBMERSIBLE PUMP HYSP400CD

User Manual

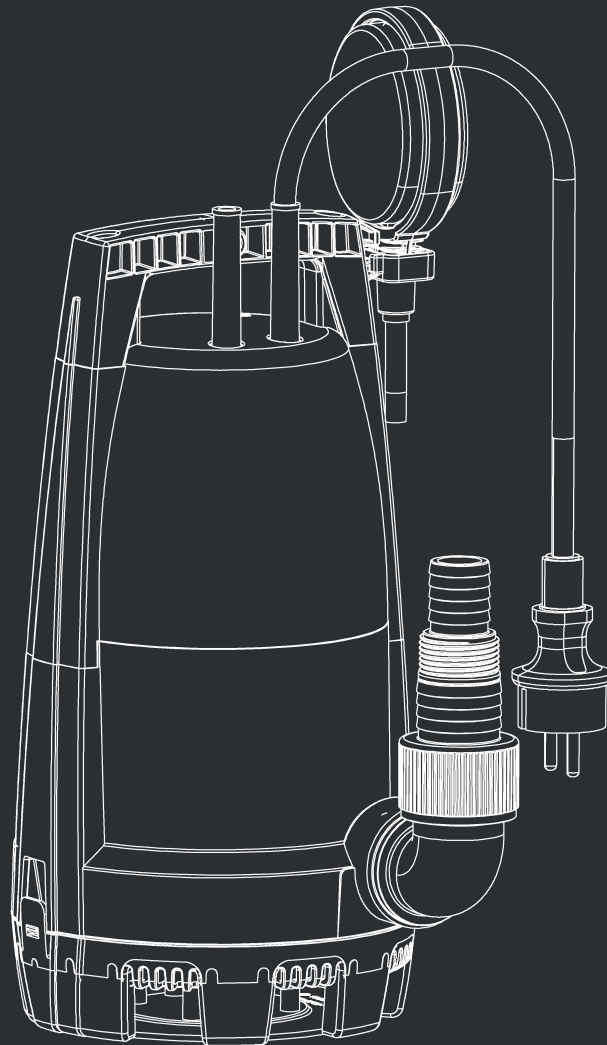

INDEX

	CONTENTS	PAGE NO.S
1	SAFETY	3 - 7
2	PART LOCATIONS	8
3	OPERATING INSTRUCTIONS	9 - 10
4	MAINTENANCE	10
5	TROUBLESHOOTING	11
6	SPECIFICATION	12
7	DECLARATION OF CONFORMITY	13
8	PRODUCT DISPOSAL & RECYCLING	14
9	CONTACT DETAILS	15
10	WARRANTY	15
11	MANUAL UPDATES	15

1. SAFETY

1.1 General Safety Notes.

- 1.2 The operator of the machine is responsible for, and has a duty of care in making sure that the machine is operated safely and in accordance with the instructions in this user manual. Keep the manual safe and pass it on if the machine is loaned or sold to another user.
- 1.3 Please note the following safety points.
- 1.4 The machine should never be left in a condition which would allow an untrained or unauthorised person/s to operate this machine.
- 1.5 All due care and diligence should be taken by the operator for the safety of and with regard to those around whilst using the machine.
- 1.6 Some or all of the following - warning signs, symbols and/or PPE pictograms may appear throughout this manual. You **MUST** adhere to their warnings. Failure to do so may result in personal injury to yourself or those around you.



DANGER

Indicates a hazard, which, if not avoided, could result in serious injury or death.



WARNING

Indicates a hazard, which, if not avoided, could result in serious injury.



CAUTION

Indicates a hazard which, if not avoided, might result in minor or moderate injury.



NOTE

Indicates a situation that could easily result in equipment damage.

READ and keep the manual safe and pass it on if the machine is loaned or sold to another user.

You **MUST** fully understand all instructions to ensure you use and operate the machine safely.

Appropriate Personal Protective Equipment (PPE), **MUST** be worn at all times when operating or repairing the machine.



HAND
PROTECTION
MUST BE WORN



EYE
PROTECTION
MUST BE WORN



PROTECTIVE
CLOTHING
MUST BE WORN



HEARING
PROTECTION
MUST BE WORN



FOOT
PROTECTION
MUST BE WORN



HEAD
PROTECTION
MUST BE WORN



RESPIRATOR
MUST BE WORN



FACE SHIELD
MUST BE WORN

1.10 Carbon Monoxide (where applicable).

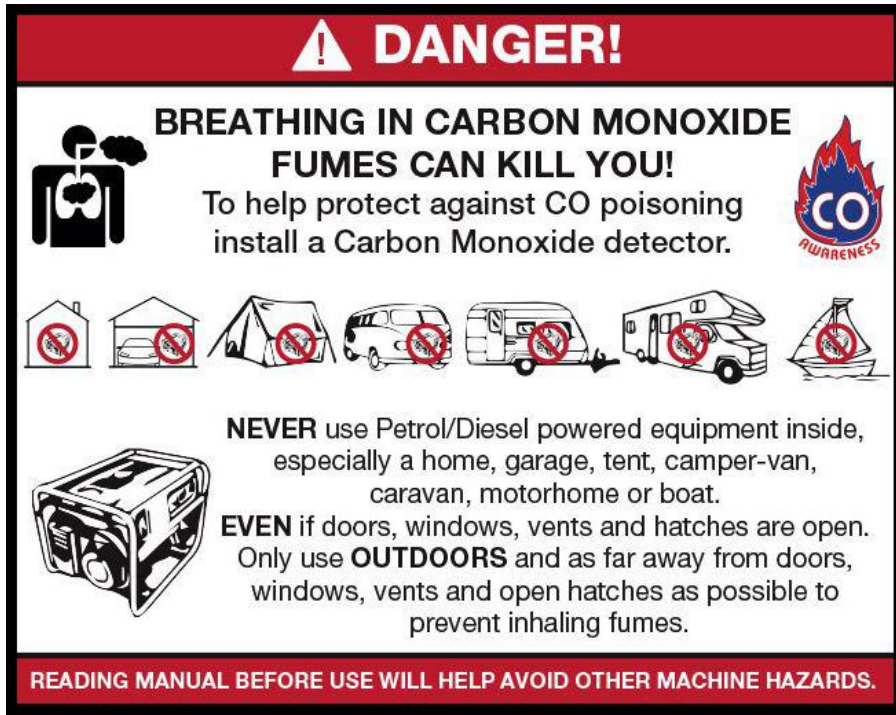

- 1.11 Carbon monoxide is a colourless and odourless gas. Inhaling this gas can cause death as well as serious long term health problems such as brain damage.
- 1.12 The symptoms of carbon monoxide poisoning can include but are not limited to the following;
Headaches, dizziness, nausea, breathlessness, collapsing or loss of consciousness.
- 1.13 Carbon monoxide poisoning symptoms are similar to flue, food poisoning, viral infections and simply tiredness. It is quite common for people to mistake this very dangerous poisoning for something else.
- 1.14 To avoid carbon monoxide poisoning **DO NOT** use Petrol/Diesel powered equipment inside any of the following; Home, garage, tent, camper van, mobile home, caravan or boat. This is not exhaustive and if you are in any doubt contact your dealer.
- 1.15 If you think you have or someone around you has been affected by carbon monoxide poisoning;
- 1.16 Get them fresh air immediately, by leaving the affected area or by opening doors and windows. If safe and practical to do so make sure that the machine is turned off. **DO NOT** enter a room you suspect of having carbon monoxide present – instead call the emergency services.
- 1.17 Contact a Doctor immediately or go to Hospital – let them know that you suspect carbon monoxide poisoning.
- 1.18 **DO NOT** use in an enclosed area or moving vehicle.

1.20 **General Fuel Safety (where applicable).**



CAUTION

ALL FUELS ARE FLAMABLE

1.21 Fire Hazard – keep fuel away from all sources of ignition for example heaters. Lamps, sparks from grinding or welding.



1.22 **DO NOT** carry out hot work on tanks that have contained fuel.

1.23 **ALWAYS** keep the work area tidy.

1.24 **ALWAYS** clean up spills promptly using absorbent granules and a lidded bin.

1.25 **ALWAYS** dispose of waste fuels correctly.

1.30 **Fueling/De-fueling (where applicable).**



CAUTION

ALL FUELS ARE FLAMABLE

1.31 **ALWAYS** fuel and defuel in a well-ventilated area outside of buildings.

1.32 **ALWAYS** wear correct, suitable and fit for purpose Personal Protective Equipment (PPE), suggested items are but not limited to safety gloves, overalls.



1.33 When fueling/de-fueling **ALWAYS** avoid inhaling fumes.

1.34 When de-fueling **ALWAYS** use a proper fuel retriever.



1.35 **ALWAYS** carry fuel in the correct and clearly marked container.

1.40 **Electrical Safety (where applicable).**

1.41 Electricity can kill – **NEVER** work on **LIVE/ENERGISED** equipment.

1.42 Prior to carrying out any maintenance work you **MUST** identify electrical isolation methods and isolate all electrical supplies.

1.43 Prior to use and with all electrical supplies isolated, you **MUST** check all electrical cables, plugs and connectors for the following;

1.44 Are intact and have no signs of damage, to include but not limited to bare wires, chaffing, cuts and loose wiring.

1.45 If there are any signs of damage, the damaged item **MUST** be taken out of service until the damage has been repaired by an electrically competent person.

1.46 All trailing cables should be routed so as not to cause any kind of trip hazard.

1.47  **NEVER** work on or near electricity with wet hands, wet clothing and wet gloves.

Risk of electric shock

1.50 Batteries (where present).

1.51 Batteries present a risk if they become damaged by the possible leaking of electrolyte. This electrolyte is an acid and can cause serious burn injuries. Care should be taken when working on or near them. **NOTE** the electrolyte may be in a liquid or gel form.

1.52 Should you come in to contact with electrolyte you should;

1.53 Remove all clothing contaminated with electrolyte. If you cannot remove then saturate them in water.

1.54 Get medical assistance as soon as possible. You must advise the medical staff of the type of acid.

1.55 Lead/acid battery = dilute sulphuric acid.

1.56 Nickel/cadmium = potassium hydroxide alkali electrolyte.

1.57 Use fresh running water to wash off excess electrolyte, continue this until medical assistance arrives. Make sure that you do not wash the electrolyte to another part of your body or face.

1.58 If electrolyte comes in to contact with Eyes the electrolyte needs to be immediately washed away with large amounts of water. Make sure that you do not wash the electrolyte to another part of your face or body.

1.59 Gasses from charging batteries are highly flammable and great care should be taken to charge in well ventilated areas.

1.59.1  There is an explosion risk if the battery terminals are short circuited, when connecting/disconnecting **ALWAYS** exercise great care so that the terminals or battery leads are **NOT** allowed to touch and cause a spark. **ALWAYS** use suitable insulated tools.

RISK OF EXPLOSION

1.60 Vibrations (where applicable).

1.61 Prolonged use of hand held (operated) machines will cause the user to feel the effects of/from vibrations. These vibrations can lead to white finger (Raynaud's phenomenon) or carpal tunnel syndrome. This condition reduces the ability of the hand to feel and regulate temperature, causing numbness and heat sensations and may cause never damage and circulatory tissue death.

1.62 Not all factors that lead to white finger disease are known, but cold weather, smoking and other diseases that affect blood vessels and blood circulation as well as large and long-lasting impact of shocks are considered factors in the formation of white finger. Note the following to reduce the risk of white finger and carpal tunnel syndrome;

1.63 Wear gloves and keep your hands warm.

1.64 Take regular breaks.

1.65 All of the above precautions may help reduce the risk of white finger disease but not rule out the carpal tunnel syndrome. Long-term and regular users are therefore

recommended to observe the condition of your hands and fingers. Seek medical attention immediately if any of the above symptoms should occur.

1.70 Noise (where applicable).

- 1.71 The operating noise of the machine can damage your hearing. Wear hearing protection such as earplugs or ear defenders to protect your hearing. Long-term and regular users are advised to have hearing checked regularly. Be especially vigilant and cautious when hearing ear protection because your ability to hear alarm warnings will be reduced.
- 1.72 Noise emissions for this equipment is unavoidable. Carry out noisy work at approved times and for certain periods. Limit the working time to a minimum. For your personal protection and protection of people working nearby it is also advisable for them to wear hearing protection.
- 1.73  See Certificate of Conformity section for Outdoor Noise declaration of conformity.

MACHINE SPECIFIC SAFETY

1.80 General Machine Safety.

- 1.81 Do not use the pump if damaged.
- 1.82 You must always inspect the pump, cables and plug for damage before use.
- 1.83 Disconnect the pump from the mains power supply before placing in or removing from the liquid to be pumped.
- 1.84 Do not carry or lower the pump by the mains cable or by the float switch. Always use the handle or a rope securely attached to the handle.
- 1.85 Keep the base of the pump clear of any debris or sediment by standing it on a platform or bricks or suspending it to the correct depth via a rope.
- 1.86 Do not insert hands into the pump whilst the machine is plugged into the mains.
- 1.87 Do not allow the pump to run dry or operate out of any liquids.
- 1.88 Do not pump explosive or flammable liquids.
- 1.89 Do not use the pump in pools or ponds where people or animals are present.
- 1.90 Do not use the pump if the liquid is liable to freeze.
- 1.91 Submersible pumps should only ever be submerged or stored vertically.
- 1.92 An approved Residual Current Device (RCD) with a tripping current of less the 30mA.

2. PART LOCATIONS

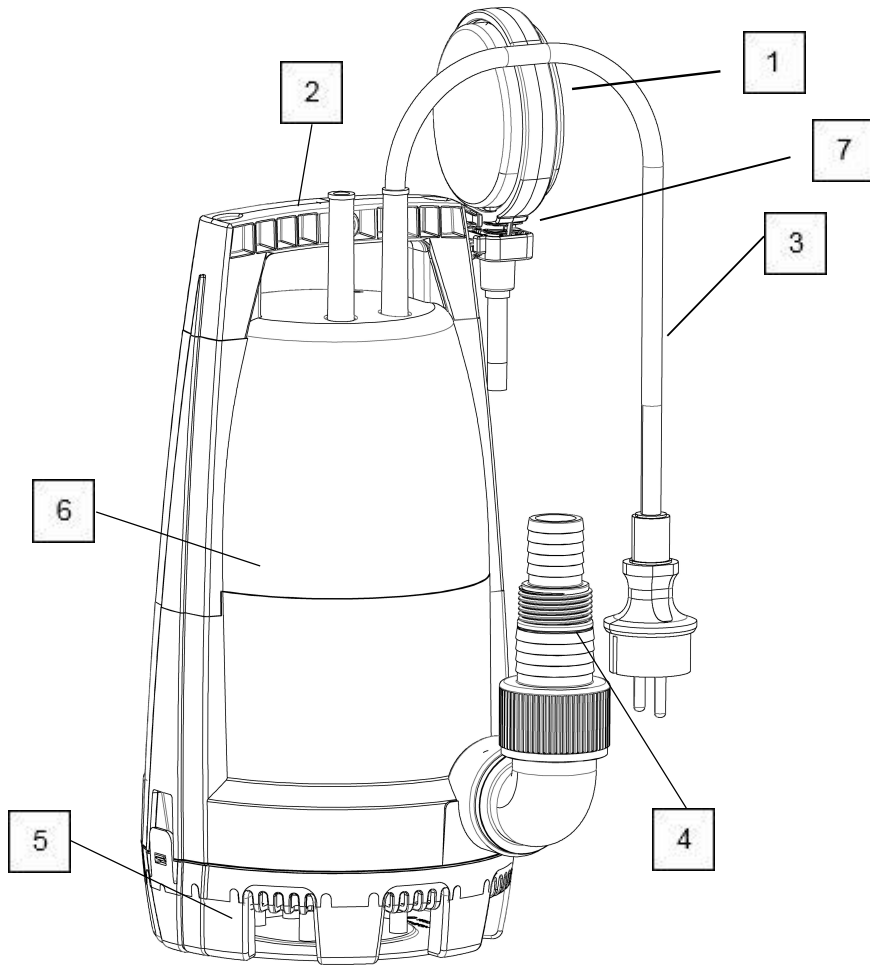

1	Float Switch
2	Carrying Handle
3	Mains Cable
4	Pump Outlet
5	Pump Base
6	Pump Body
7	Float Switch Depth Clip

3. OPERATING INSTRUCTIONS



NOTE

Attach a sufficiently long and strong rope to the handle before first use. The pump is submerged into the liquid by using the rope. In case of continuous use of the pump with the rope, the condition of the rope must be checked regularly.



NOTE

DO NOT allow the pump to run dry.



NOTE

The pump must be checked for damage before operation. The liquid being pumped will become contaminated if this pump becomes damaged and lubricant within the pump escapes.

MAXIMUM SOLIDS DIAMETER: 30mm

ASSEMBLY

- 3.0 Screw the elbow into the outlet on the pump body.
- 3.1 Connect the required diameter pump outlet hose adapter.
- 3.2 Connect the hose (not supplied) to the pump outlet adapter.

NOTE: Reducing the hose diameter will affect the maximum flow rate.

SETTING UP THE PUMP

- 3.3 Adjust the depth of the float switch to the desired depth by clipping the float switch cable into the float switch depth clip at the desired level.
- 3.4 Insert the pump into the liquid at a 45° angle to help remove as much air as possible.
- 3.5 If there is any debris or sediment in the liquid, the pump should be placed vertically on a platform, bricks or similar.
- 3.6 You must place the pump so there is adequate space for the float switch to operate without obstruction.
- 3.7 Always raise or lower the pump using a suitable rope attached to the carrying handle and not by the mains or float switch cable.

USING THE PUMP

- 3.8 Connect the pump to the mains.
Always use a high sensitivity Residual Current Device (RCD) with a tripping current of less than 30mA.
- 3.9 Turn the mains supply on.

- 3.10 The pump will begin to drain the liquid.
- 3.11 As the liquid level falls, so will the float switch.
- 3.12 Once the float switch reaches the desire depth, the pump will automatically turn off.
- 3.13 When finished, disconnect the pump from the mains power supply.

4. MAINTENANCE



WARNING

Before carrying out any maintenance, cleaning or inspection you **MUST** unplug the pump from the mains power supply.
If the pump is hard wired, ensure the circuit breaker is open.



NOTE

Do not attempt to repair the pump as you may damage waterproof seals.
Repairs must be carried out by an authorised dealer.

- 4.0 The pump requires no maintenance other than regular inspection and cleaning.
- 4.1 Inspect the mains and float switch cable for wear or damage.
- 4.2 Remove any obstructions from the base of the pump and impeller.

CLEANING

- 4.3 Rinse the exterior of the pump with clean water.
- 4.4 Remove stubborn contamination with a brush.
DO NOT use solvent based cleaning products as these could damage plastic parts.
- 4.5 Submerge the pump in a container with clean water and switch on the pump for a short time to rinse the inside of the pump.
- 4.6 Clean all accessible internals of the pump casing.
- 4.7 Remove any fibres that may have wound around the rotor shaft by opening the pressure connection.

STORAGE

- 4.8 Clean the pump before storage following the procedure laid out in sections 4.3 to 4.7.
- 4.9 Store the pump upright away from extremes of temperate change.
- 4.10 If there is a risk of frost or freezing, dismantle the appliance and accessories and store away from the risk of frost or freezing.

5. TROUBLESHOOTING

Problem	Possible Cause	Possible Solution
Pump will not start	No mains power	Turn on mains power
	Fuse blown	Inspect and replace fuse
	Internal thermal cut out has not reset	Leave 5 to 10 minutes and try again
	Extension cord faulty	Replace extension cord
	Impeller jammed	Disconnect from the mains power supply and remove the impeller obstruction
	Float switch stuck against obstruction	Remove the obstruction
Pump starts but will not pump	Blocked inlet	Check the inlet and remove obstruction
	Blocked outlet	Check the outlet and remove obstruction
	Exceeded maximum pump head	Check the specifications for maximum head
	Air trapped inside the pump	Remove and reinsert the pump at an angle to remove trapped air
	Impeller may be damaged	Consult your dealer
Pump will not stop	Float switch prevented from moving to fully down position	Remove obstruction
	Faulty float switch	Consult your dealer
Pump stops running	Thermal overload	Turn the pump off and leave for 5 to 10 minutes
	Pump has run dry	Submerge the pump
	Impeller jammed	Turn off the pump and remove the obstruction

6. SPECIFICATION

Model	HYSP400CD
Voltage – v	230v – 50Hz
Power – w	400
Max Flow Rate – l/h	11000
Head – m	5.8
Max Depth – m	7
Outlet Hose Size Inlet Diameter	25mm-35mm
Max Solid Diameter – mm	30
Max Water Temperature - °C	35
Weight – kg	4.5

7. DECLARATION OF CONFORMITY

7.0 Genpower Ltd confirms that this Hyundai product conforms to the following CE Directives;

LVD Directive: 2014/35/EU
EMC Directive: 2014/30/EU
Directive ROHS 2011/65/EU

EC DECLARATION OF CONFORMITY

The undersigned. As authorised by: **Genpower Ltd**
Declares that the following equipment manufactured under licence by Hyundai Korea

Conforms to the Directive:-
2000/14/EC (as amended)

Of the European Parliament and of the council on the approximation of the laws of the Member States relating to the noise emission in the environment by equipment for the use outdoors.

Equipment Category: **Garden Machinery**
Product Name/Model: **HYSP400CD**
Type/Serial No: **Electric Submersible Pump**
Net installed power: **400w**
The technical documentation is kept by: **Roland Llewellyn, Genpower Ltd
Isaac Way, Pembroke Dock,
Pembrokeshire, SA72 4RW.**

The conformity assessment procedure followed was in accordance with annex V of the Directive.

Notified Body: **Grand-Duche De Luxembourg
Ministere du Developpement Durable
et des Infrastructures L-2938 Luxembourg
Certification n° e13*2016/1628*2017/656SRA1/P*0081*0**

Measured Sound Power Level: **56dB**

Guaranteed Sound Power Level: **56dB**

A copy of this certificate has been submitted to the European Commission and the EU Member State United Kingdom.

Place of Declaration: **Pembroke Dock, SA73 4RW**

Date: **07/03/2018**

Signed by: **Roland Llewellyn**



Position in Company: **Managing Director**

Name and address of manufacturer or Authorised representative:

**Genpower Ltd
Isaac Way, Pembroke Dock,
Pembrokeshire, SA72 4RW**

8. PRODUCT DISPOSAL & RECYCLING

- 8.0 We do not offer a take back scheme for the recovery of Waste Electrical Electronic Equipment (WEEE) & Batteries.
Instead the responsibility to dispose of WEEE and or batteries is passed onto you by us.
So when it becomes necessary to dispose of your machine you must take it to your Local Civic Amenity Site.
For further information please contact your Local Authority for disposal advice.
- 8.1 You MUST make sure that all unused oil and fuel is disposed of correctly either beforehand or at your local Civic Amenity Site.
Under NO circumstances must any fuel or oil be put down any drains.
- 8.2 Certain products contain WEEE waste which should not be disposed of in your domestic waste.
- 8.3 You MUST recycle WEEE in accordance with your local authority or recycling centre.
- 8.4 Certain products contain batteries which should not be disposed of in your domestic waste.
- 8.5 You MUST recycle batteries which should not be disposed of in your domestic waste.
- 8.6 Unwanted packaging and materials should be stored and taken to a recycling centre so they can be disposed of in a manner which is compatible with the environment.
- 8.7 The following symbol means you should 'Reduce – Reuse - Recycle'
- 8.8 We are members of VALPAK National Compliance Scheme and our registration number is RM08660.
- 8.9 For further information about disposal please contact your Local Authority.
- 8.10 You can also get more advice and guidance about recycling at the following website <http://recycle-more.co.uk>
- 8.11 Should you pass this product on to another user either sold or loaned, you MUST pass on this manual.
This will make sure that all other users can use and maintain this machine safely.

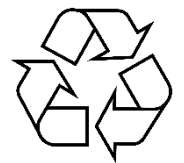
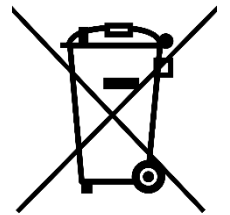

9. CONTACT DETAILS

9.0	ADDRESS	Genpower Ltd, Isaac Way, London Road, Pembroke Dock, Pembrokeshire. SA72 4RW. UK
9.1	TELEPHONE	+44 (0) 1646 687 880
9.2	SUPPORT	aftersales@hyundaipowerproducts.co.uk
9.3	WEBSITE	www.hyundaipowerproducts.co.uk

10. WARRANTY

- 10.0 Proof of purchase will be required before you make a warranty claim. Full warranty terms and conditions can be found on the HYUNDAI POWER PRODUCTS website:

www.hyundaipowerproducts.co.uk

- 11.0 Our manuals are constantly being reviewed and updated. However if you find an error, omission or something you find unclear, please contact your dealer for assistance.

- 11.1 Our latest manuals are also placed online.

HYUNDAI

POWER PRODUCTS

Importer:

GENPOWER LTD

Isaac Way, London Road

Pembroke Dock, UNITED KINGDOM, SA72 4RW

T: +44 (0) 1646 687 880 F: +44 (0) 1646 686 198

E: info@hyundaipowerproducts.co.uk

www.hyundaipowerproducts.co.uk

Imported/Distributed by GENPOWER LTD for The United Kingdom & Ireland

Licensed by Hyundai Corporation, Korea

