

LED LCD HDTV

OWNER'S GUIDE



For Model:

VZ556100

Remote Control



POWER: Set the unit in standby mode; press it again to switch it on.

SOURCE: Switch the input source.

FAV: Press to display your favourite channel in DTV mode.

D-SETUP: Display the main disc menu (DVD).

INDEX: Access the list of recorded programs

CH. LIST: Access the channel list.

◀▶: Play the previous file.

● RECORD: Record program in DTV mode.

■: Stop playback in TIMESHIFT and MEDIA modes.

▶▶: Play next file.

◀◀: Move fast backward

||: PLAY/PAUSE in TIMESHIFT and MEDIA modes.

▶▶: Move fast forward.

▲: Open or close the disc compartment (DVD).

SMART HUB: Access the smart hub page.

MENU: Display the main TV menu.

VOL +/-: Turn the volume up/down.

CH+/-: Press to play the next or previous channel; press repeatedly to scan through the channels.

◀ / ▶ / ▲ / ▼: Press the UP/DOWN/RIGHT/LEFT buttons to navigate the on-screen menus and adjust the system settings to your preference.

After Sales Support

Telephone: 1300 886 649
Email: info@tempoaustralia.com.au

Remote Control



OK: Confirm selection.

MUTE: Mute the sound. Press again or press V+ to restore the sound.

RETURN: Go back to previous page.

EPG: Launch the Electronic Program Guide (DTV)

D.MENU: Display the main disc menu.

SUBTITLE: Enable/disable subtitles.

EXIT: Exit from the main TV menu displayed on the screen.

TITLE: Display the DVD title menu (DVD).

INFO: Display information of the current program.

NUMBER BUTTONS (0-9): Press to select a TV channel directly when watching TV. The channel changes after 2 seconds.

COLOR BUTTON: Red, Green, Yellow, Blue keys to execute different functions according to current prompt under FreeviewPlus app menu.

S.MODE: Cycle through the different sound modes

P.MODE: Cycle through the different picture modes.

NOTE: DVD related functions are not available in VZ556100.

Remote Control (Cont.)

Using the remote control

To use the remote control, point it towards the remote sensor at the front of the television.

The remote control has a range of up to approximately six metres (6m) from the TV at an angle of up to 30 degrees each to the right and left of the sensor, as illustrated on the right.

The remote control will not operate if its path is blocked.

NOTES:

- Do not drop, step on or otherwise impact the remote control. This may damage the parts or lead to malfunction
- The operating distance may vary according to the brightness of the room.
- Do not point bright light at the remote control sensor.
- Do not place objects between the remote control and the remote control sensor.
- Do not use this remote control while simultaneously operating a remote control of other devices.

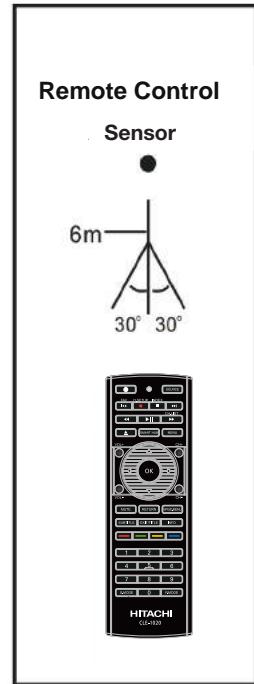

Welcome

Congratulations on choosing to buy a HITACHI product. All products brought to you by HITACHI are manufactured to the highest standards of performance and safety and, as part of our philosophy of customer service and satisfaction, are backed by our comprehensive 2 Year Warranty. We hope you will enjoy using your purchase for many years to come.

After Sales Support

Telephone: 1300 886 649

Email: info@tempoaustralia.com.au



Contents

Remote Control	ii
Welcome	vi
General Safety Instructions	1
Installation	5
Controls and Connections	7
Getting Started	15
Basic Operations	19
Electronic Program Guide (EPG)	21
Recording	22
Smart Hub	25
Media Mode	28
Menus	32
FAQs	51
Maintenance and Recycling	53
Specifications	54
Warranty	55

General Safety Instructions

Read this manual thoroughly before first use and keep it in a safe place for future reference, along with the completed warranty card, purchase receipt and carton. The safety precautions enclosed herein reduce the risk of fire, electric shock and injury when correctly adhered to.

Follow all instructions and take notice of all the warnings.

 CAUTION RISK OF ELECTRIC SHOCK DO NOT OPEN		<p>The lightning flash with an arrowhead symbol within an equilateral triangle is intended to alert you to the presence of non-insulated dangerous voltage within the product's enclosure that may be of sufficient magnitude to constitute a risk of electric shock to persons.</p>
<p>To reduce the risk of electric shock, do not remove the cover (or back). This unit contains no user-serviceable parts inside. Refer all servicing to qualified service personnel only.</p>		<p>The exclamation point within an equilateral triangle is intended to alert you to the presence of important operating and maintenance (servicing) instructions in the literature accompanying the product.</p>

IMPORTANT WARNINGS AND CAUTIONS!

- Only connect this TV to a mains socket with a protective earthing connection.
- To prevent damage which may result in fire or an electric shock hazard, do not expose this appliance to rain or moisture.
- Do not change or modify the appliance in any way.
- Only use the attachments/accessories specified by the manufacturer.

IMPORTANT INFORMATION

- If a television is not positioned in a sufficiently stable location, it can be potentially hazardous due to falling. Many injuries, particularly to children, can be avoided by taking simple precautions such as:
 - Using cabinets or stands recommended by the manufacturer of the television.
 - Only using furniture that can safely support the television.
 - Ensuring the television is not overhanging the edge of the supporting furniture.
- Not placing the television on tall furniture (for example, cupboards or bookcases) without anchoring both the furniture and the television to a suitable support.
- Not standing the televisions on cloth or other materials placed between the television and supporting furniture.
- Educating children about the dangers of climbing on furniture to reach the television or its controls.

After Sales Support

Telephone: 1300 886 649
Email: info@tempoaustralia.com.au

General Safety Instructions (Cont.)

Installation

- **Follow instructions:** Only install this TV set in accordance with the instructions in this manual. If a television is not positioned in a sufficiently stable location, it can be potentially hazardous due to falling and causing injury, particularly to children.
- This TV is equipped with standard wall-mounting points, and **we recommend that a wall bracket be installed between the TV and the wall to prevent the TV from falling from a cabinet.** (The bracket is not included.)
- To prevent injuries from your television falling, take a few simple precautions:
 - Do not place the TV on tall furniture (e.g., on a cupboard or bookcase) without anchoring both the furniture and the TV to a suitable support.
 - Only use furniture that can safely support the television.
 - Ensure the TV is not overhanging the edge of the supporting furniture.
 - Educate children about the dangers of climbing on furniture to reach TV controls.
 - Do not place the TV on cloth or other materials.
- When deciding on where to put the TV set, make sure the place is:
 - Well ventilated, and away from damp and cold.
 - Protected from overheating and away from direct sunlight.
 - Away from moisture drips or splashes.
 - Protected from excessive dust or grease.
- **Bookcase:** Do not install this equipment in a confined space such as a bookcase or similar unit.
- **Heat:** Do not install the TV set near heat sources such as radiators, stoves or other audio visual equipment (including amplifiers) that produce heat.
- **Water:** Do not place containers with liquids (such as vases) or with small metallic objects on top of the unit. If liquid enters the unit or any metal object falls into the unit, it may result in short-circuit, fire or electric shock.
- **Fire or explosion:** Do not use or store flammable or combustible materials near the unit. Doing so may result in fire or explosion. Do not place any naked flame sources, such as lit candles, cigarettes or incense sticks on top of the TV set.

Warning: To prevent the spread of fire, keep candles or other open flames away from this product at all times.
- **Antenna:** Install the antenna away from high-voltage power lines and communication cables and make sure it is installed securely. If the antenna touches a power line, contact with the antenna could result in fire, electric shock or serious injury.
- **Ventilation:** Install the unit at an adequate distance from the wall to ensure sufficient ventilation. If the temperature inside the unit rises, it may result in fire.

General Safety Instructions (Cont.)

Electrical safety and cord handling

- **Voltage:** Before installing this TV set, make sure your outlet voltage corresponds to the voltage stated on the appliance rating label.
- **Protect from moisture:** To reduce the risk of fire or electric shock, do not expose this appliance to rain or moisture; do not use it anywhere near water; do not touch the power plug with wet hands.
- **Damage:** Do not use a damaged power cord, plug or loose outlet. Doing so may cause an electric shock.
- **Power outlet:** Do not plug several devices into the same outlet. Doing so may cause the outlet to overheat and start a fire. Make sure the outlet is readily accessible during operation of the equipment.
- **Power plug:** Make sure the plug is properly installed before inserting it fully into the outlet. A loose or improperly inserted power plug may cause a fire.
Warning: The mains plug/appliance coupler is used as disconnect device, the disconnect device shall remain readily operable.
- **Protect the cord:** Do not bend, twist or kink the power cord excessively. Do not allow anything to rest on or roll over the power cord and antenna cable. Doing so may cause a fire or an electric shock. Do not run the power cord near heat-producing appliances such as radiators, stoves or irons. The excessive heat could melt the insulation and expose live wires, resulting in fire or electric shock.
- **Disconnect:** Always grasp the plug when disconnecting the power cord. Pulling the cord can damage the internal wire and may cause a fire.
- **Lightning storms:** Unplug this TV during lightning storms or when unused for long periods of time. Not doing so may result in fire or electric shock.

Usage conditions and restrictions

- **Adjustments:** Follow the instructions in this manual when installing and adjusting the TV set. Only adjust those controls that are covered in this manual, as improper adjustment of other controls may result in damage. If this happens, unplug the TV set and have it serviced by appropriately qualified personnel, or phone the after sales support line for advice.
- **Ventilation:** Do not cover the ventilation openings with items such as newspapers, tablecloths, curtains etc. as this could impede ventilation.
- **Cabinet slots:** Do not insert objects of any kind into this unit through the cabinet slots, as they could touch the current-carrying parts or short-circuit parts, resulting in fire, electric shock or damage to the unit.
- **Smoke or odour:** If you notice any unusual odours or smoke around the unit, immediately disconnect the unit from the outlet and contact the service centre. Failure to do so may result in fire or electric shock.

General Safety Instructions (Cont.)

- **When not in use:** When not using the unit for long periods of time, disconnect the power cord from the wall outlet. Dust could accumulate over time on the unit and cause it to generate heat and ignite, or deteriorate insulation, which in turn may result in an electrical fire.
- **Moving:** When moving the unit, be sure to turn it off and unplug it from the wall outlet. Moving the unit with the power cord connected to the outlet may cause damage to the cord, resulting in fire or electric shock.
- **Batteries:** When removing the batteries from the remote control, make sure to keep them out of reach of infants and children. Seek medical attention immediately if a child has swallowed a battery.
Warning: The battery (battery or batteries or battery pack) shall not be exposed to excessive heat such as sunshine, fire or the like.
- **Usage restriction:** This product is not intended for use by persons (including children) with reduced physical, sensory or mental capabilities, or lack of experience and knowledge, unless they have been given supervision or instructions concerning use of the product by a person responsible for their safety.
- **Children:** Supervise young children to ensure they do not play with the TV.

Cleaning and maintenance

- **Unplug:** To reduce the risk of fire and electric shock, always unplug the TV before cleaning.
- **Cleaning:** Only use a soft, dry cloth for cleaning the TV; do not use a damp cloth. Never clean with industrial strength polish, wax, benzene, paint thinner, air freshener, lubricant, detergent or other chemicals. Wipe off any moisture, dirt or dust on the power plug pins with a clean, dry cloth.
- **Repair:** If the unit requires repair, contact the after sales support line; never disassemble or modify the unit or attempt to service it yourself.
- **Service:** Refer all servicing to qualified service personnel. Servicing is required when the TV has been damaged in any way, such as when the power supply cord or plug is damaged, liquid has been spilled or objects have fallen into the TV, when the TV has been exposed to rain or moisture, does not operate normally, or has been dropped.

 This equipment is a Class II or double insulated electrical appliance. It has been designed in such a way that it does not require a safety connection to electrical earth.

Installation

Your TV is packaged with the stand and the cabinet separated. Before using the TV, install the stand as described below, or if you want to mount it to a wall, see page 6 for mounting advice; the wall mount itself is not supplied.

IMPORTANT!

- Make sure the TV set is unplugged from the power supply before installing or removing the stand.
- The TV panel may be awkward to install on your own. We recommend you ask someone to help with installation and/or removal of the stand.

Attaching the stand

Step 1

Place a soft cushioned material on top of a flat surface to prevent damaging the screen panel. Then place the TV monitor flat on top, with the screen side facing down, as illustrated on the right (1).

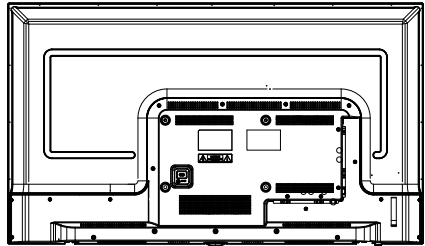

Step 2

Align the screw holes on the stand and the bottom of the TV, as illustrated on the right (2).

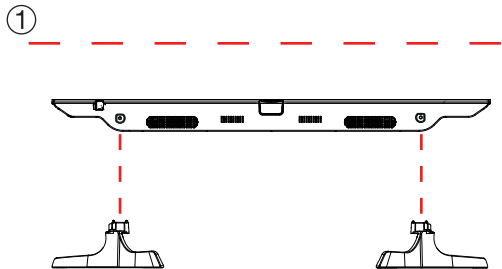

Step 3

Tighten the screws (supplied) with a screwdriver to affix the stand to the panel, as illustrated on the right (3).

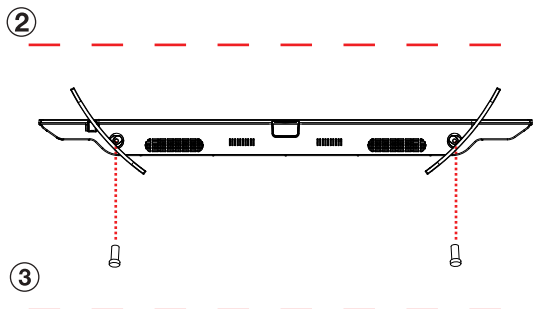

NOTE: Do not apply excessive force as this may damage the screw holes.

Installation (Cont.)

Wall-mounting instructions

IMPORTANT!

- Make sure the TV set is unplugged from the power supply before wall-mounting it and removing the stand.
 - We recommend you contact a professional for assistance when wall-mounting the TV. We assume no liability for any eventual damage to the product or injury to yourself if you mount the TV on your own.
-
- The TV set is equipped with holes on the back panel for use with wall-mounting brackets (not included). Please use the illustration below as a reference when buying wall-mounting brackets. Hole pattern is 200mm(H) x 300mm(W).
 - Use four standard M6*20mm screws (or longer, depending on the mounting bracket) to mount this TV.

Back of the TV

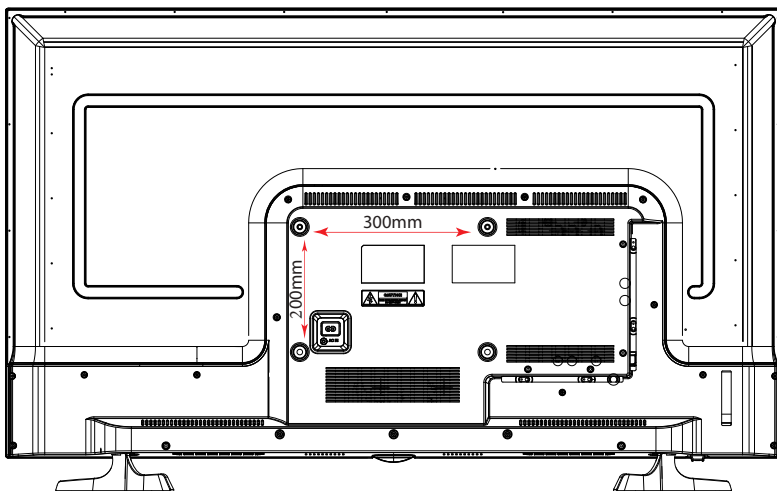

NOTE: The screws in the package are for securing the TV stand only. If you are wall-mounting the TV, please consult a qualified installer for further instructions on bracket support and wall support.

Controls and Connections

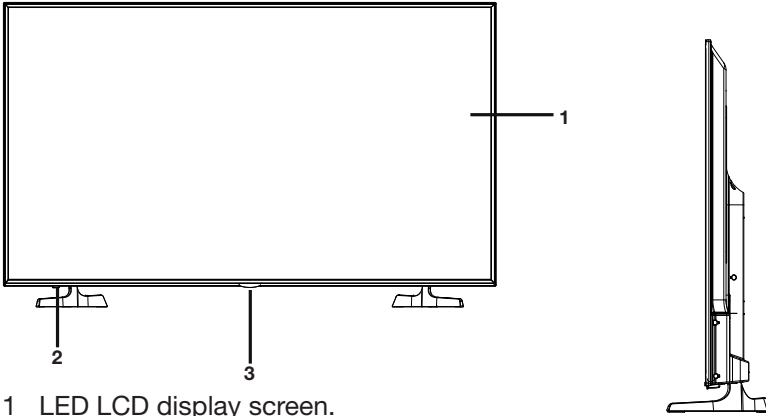

- 1 LED LCD display screen.
- 2 IR (infra-Blue) sensor for remote control.
- 3 Power indicator.

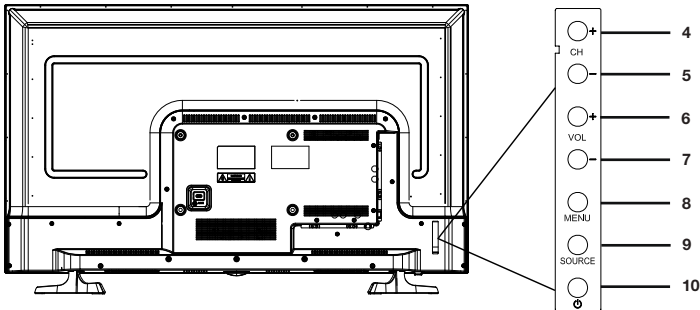

- 4 CHANNEL +: select the next channel or move up/down.
- 5 CHANNEL -: select the previous channel or move up/down.
- 6 VOLUME +: increase the volume level or move left/right.
- 7 VOLUME -: decrease the volume level or move left/right.
- 8 MENU: enter the settings menu.
- 9 SOURCE : select the input source.
- 10 POWER: turn the TV on/off.

NOTE: See page 8 for a detailed description of all sockets on the back panel.

Keypad may change model to model

After Sales Support

Telephone: 1300 886 649
Email: info@tempoaustralia.com.au

Controls and Connections (Cont.)

Main unit back view controls and sockets

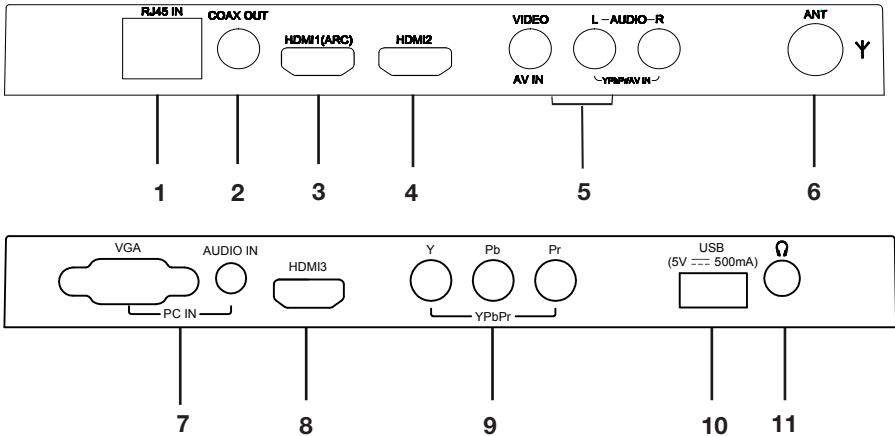

- 1 RJ45 IN: Plug in network cable to connect to the internet
- 2 COAXIAL S/PDIF output
- 3 HDMI 1 (supports ARC function)
- 4 HDMI 2
- 5 AV IN
(Audio R/L input is share between YPbPr and AV inputs)
- 6 ANT input: for connection of the external antenna
- 7 PC AUDIO input / VGA input (for PC connection)
- 8 HDMI 3
- 9 YPbPr (Component) input
- 10 USB input terminal: for multimedia file playback and time-shift functions
- 11 EARPHONE output

Input / Output may change model to model

Controls and Connections (Cont.)

IMPORTANT!

- Ensure all cables are disconnected from the main unit before connecting the TV to an AC power source.
- Read through the instructions before connecting the TV to other equipment.

Connecting to an AC power source

To power outlet

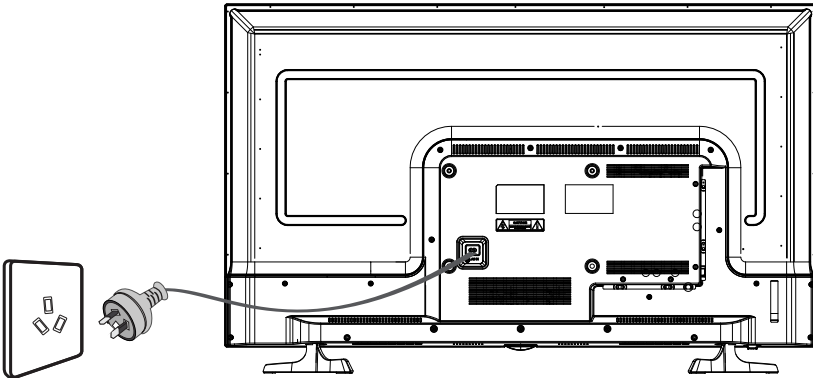

Connecting an external antenna

For best picture quality, we recommend connecting the TV set to an external antenna.

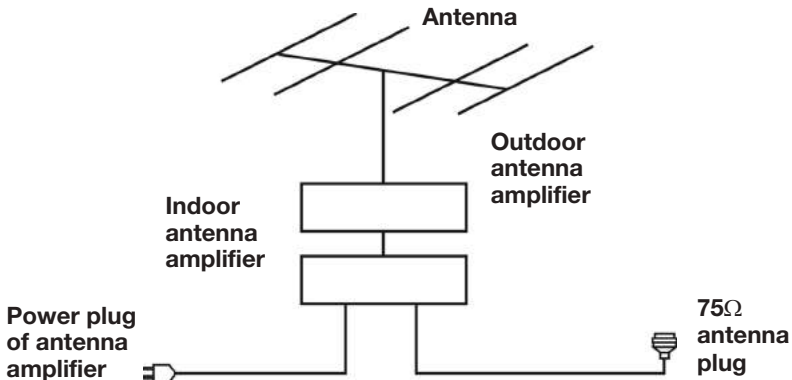

After Sales Support

Telephone: 1300 886 649
Email: info@tempoaustralia.com.au

Controls and Connections (Cont.)

Internet connection

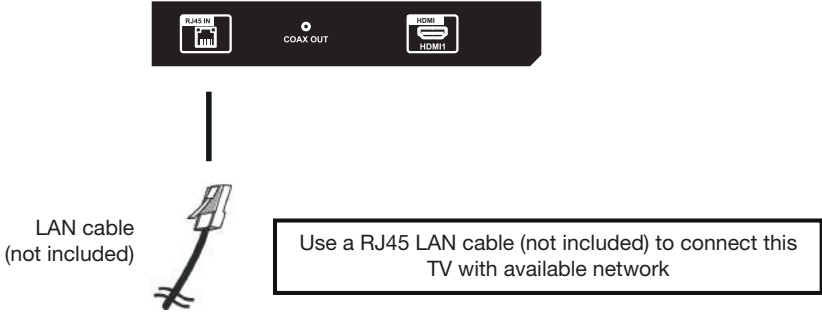

Coaxial (S/PDIF) connection

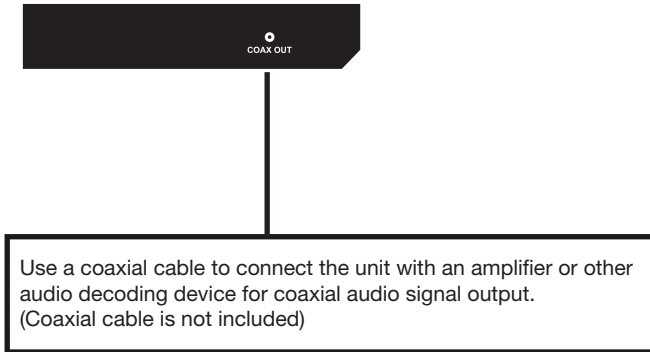

Controls and Connections (Cont.)

HDMI connection

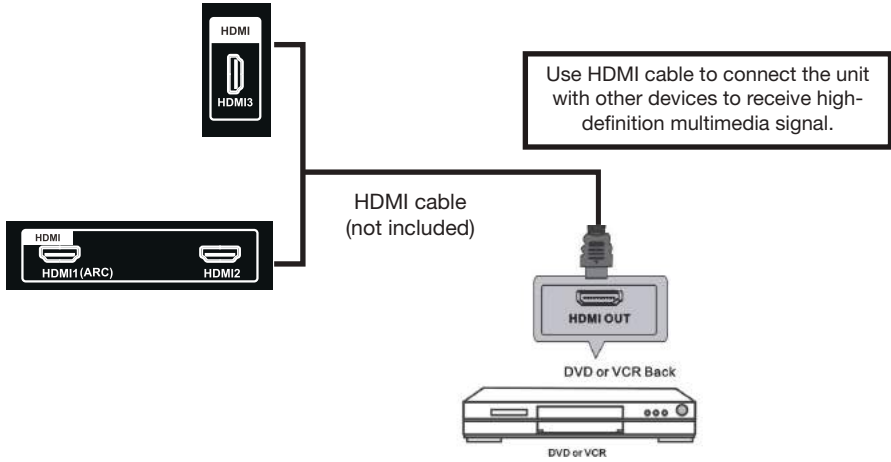

Composite video (AV) connection

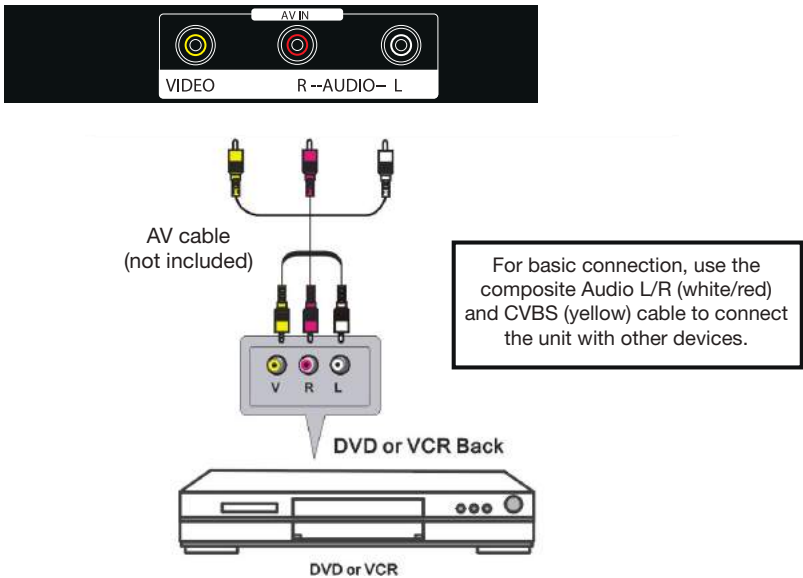

NOTE: AV adapter cable's L/R audio connections are shared between Y/Pb/Pr as well.

After Sales Support

Telephone: 1300 886 649
Email: info@tempoaustralia.com.au

Controls and Connections (Cont.)

PC/VGA connection

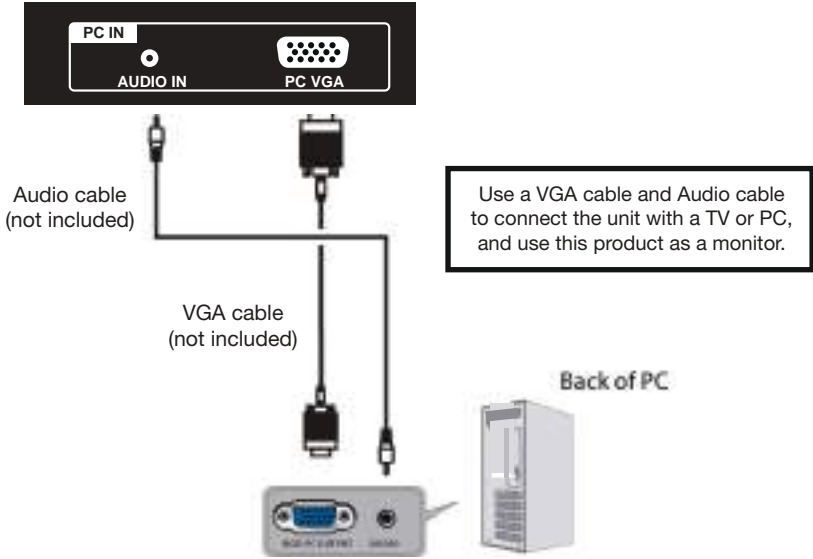

Controls and Connections (Cont.)

Component (YPbPr) connection

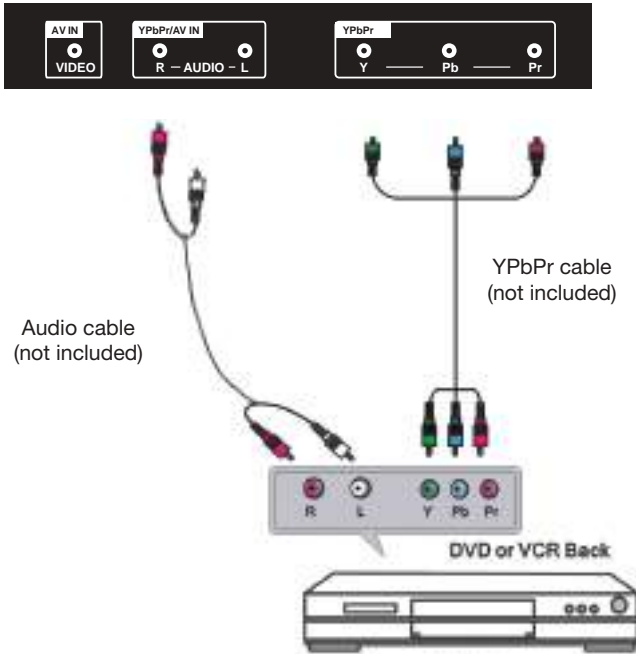

After Sales Support

Telephone: 1300 886 649
Email: info@tempoaustralia.com.au

Controls and Connections (Cont.)

USB connection

Insert a USB memory device into the USB port for PVR recording, time-shifting and playback of video/music/photo multimedia files.

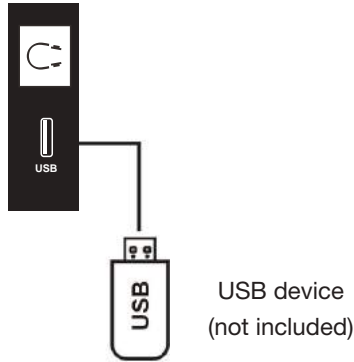

Earphone connection



Getting Started

IMPORTANT! Make sure all relevant equipment is properly connected (as illustrated on the previous pages) before connecting the unit to a wall socket and turning on the power.

Powering the TV

To turn the power on or off:

- Plug the power cord into a suitable power point, then turn on the power at the outlet.
- Press the POWER button, on the lower side of the back panel (or on the remote control, making sure to aim it at the sensor at the front of the TV); the indicator will glow blue. Press it again to power off (standby mode); the indicator will glow red.

Installation Guide

When you switch on the TV for the first time, the First Time Setup menu will be displayed on the screen, as illustrated below.



Step one:

OSD language: Use the ▲/▼ buttons to select your OSD language and then press the OK button to go to the next step.

Getting Started

Step two:

Country: Use the ▲/▼ buttons to select the country you are living in and then use the OK button to go to the next step. Press MENU button to go to previous step.



Step three:

Environment: Use the / buttons to select the environment of your new TV and then use the OK button to go to the next step. Press the **MENU** button to go to the previous step.

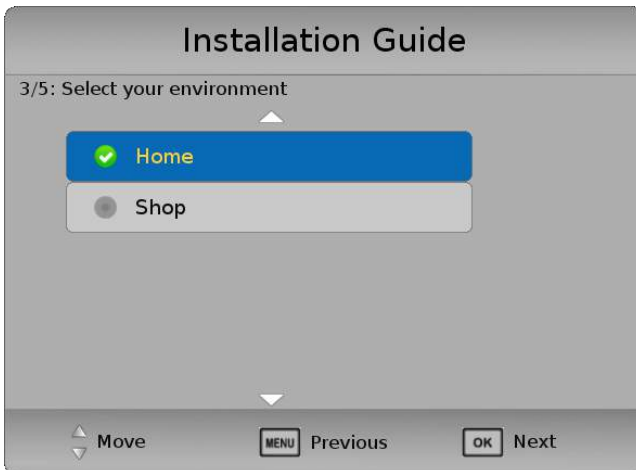

Getting Started

Step four:

Network: Select "Start" and click OK to begin the network setup. Press ► key to select "Skip" and press OK to cancel the network setup and move to next step. Press MENU button to go to previous step.

Press </> to select Wired or Wi-Fi connectivity type. Press down to select your chosen connectivity type and press OK to view IP settings. Press OK to save settings.

You can configure the network settings later via the TV's menu. See page 36 for detailed network setup instructions.



Step five:

Tuner: Use the ▲/▼ buttons to select the type of scan (ATV, DTV, DTV+ATV) and then use the OK button to go to the next step. Press MENU button to go to previous step.

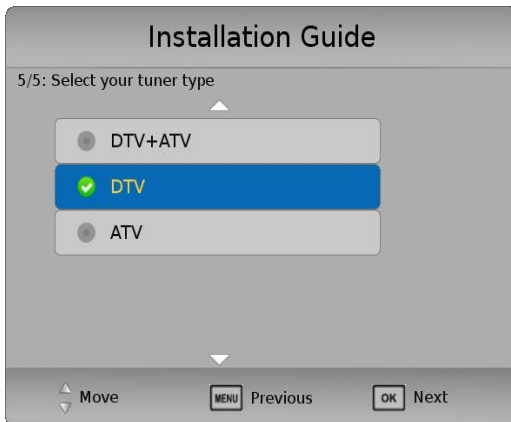

After Sales Support

Telephone: 1300 886 649
Email: info@tempoaustralia.com.au

Getting Started

Settings confirmation page will be displayed on the screen, as illustrated below. Press menu button to go back previous step.



Press OK button to begin scanning for TV stations. To exit channel tuning, press the EXIT button. When auto searching is complete, your TV will show the first channel found.

Basic Operations

Selecting an input source

- Press the SOURCE button at the lower-left side of the back panel, or on the remote control, to display the input source list.
- Press the ▲/▼ /left/right to select the desired input source, and then press OK to confirm your selection from the following options: DTV, ATV, AV, YPBPR, PC, HDMI1, HDMI2, HDMI3, MEDIA.

NOTE: When you switch on this TV for the first time, you need to go through the First time installation wizard and auto-search for all the DTV programs in your area.

Channel selection

- Press the CH+/- button to select the next/previous channel.
- Alternatively, press the number buttons to select a channel directly.

Volume contro

- Press the VOL+/- button to adjust the volume level.
- Press the MUTE button to mute the sound, press it again to restore sound.

Picture and sound mode

- Press the P-MODE button on the remote control repeatedly to select the picture mode directly (available options: Standard, Movie, User, Eco, Dynamic).

The manufacture 's recommended home viewing mode is Standard mode.

- Press the S-MODE button on remote control repeatedly to select the sound mode directly (available options: Standard, Music, Movie, Sports, User).

Information display

- Press the INFO button to display information about the current program.

Basic Operations (Cont.)

Favourites List

- While viewing a channel, press the FAV button on the remote control to enter the Favourites List menu.
- Press the ▲/▼ button to select the channel and press OK to watch it.
- To add a channel to the Favourites List, go to SMART HUB > select 'Channel' and press OK > Select 'Program Edit' and press OK > Press up/down arrow keys to select a channel and press FAV key.
- Press FAV key again to remove a favourite channel from the list.



Quick select

- While viewing a channel, press the CH.LIST button to enter the Channels List directly.
- Press the ▲/▼ buttons to select the channel and press OK to watch it.

Subtitles

- Press the SUBTITLE button on the remote control to enter the subtitle menu.
NOTE: The program you are watching must support subtitles.



Electronic Program Guide (EPG)

EPG TV Guide (for DTV mode only)

EPG stands for Electronic Program Guide. It is supplied by the program providers and offers information about the programs to be broadcast. You can access it in digital mode by pressing the EPG button on the remote control.



- Press the EPG button to display the EPG interface (above). The area at the top will display information about the selected program or channel, and the columns below will display the list of available channels and their programs at various timeslots.
- Before you can view any EPG information, you have to 'activate' every channel for which you want to view program information. To do this, use the ▲ / ▼ buttons to select a channel in the left column, then press OK to confirm.
- Press the ◀/▶ buttons to switch between columns.
- Press the ▲/▼ buttons to select a different channel/program in the list and press OK to activate the channel.
- Press the ⏮ button to display the TV guide of the previous day.
- Press the ⏭ button to display the TV guide of the next day.
- Press the 🟡 YELLOW button to enter the schedule list page.
- Press the 🟢 GREEN button to schedule a reminder for the selected program
- Press the 🔴 or 🟠 RECORD button to schedule a recording for the selected program.
- Press the INFO button to display full program information.
- Press EXIT to exit the EPG menu.

Recording

One-touch recording (in DTV mode only)

IMPORTANT!

Before you can record with this TV set (including time-shift recording), you must have inserted a FAT32 formatted USB storage device into the USB port.

- First, insert your USB memory device into the USB port.

When watching a program in DTV mode:

- Press the **RECORD** button on the remote control to start recording directly. Press the **EXIT** button to minimize the information bar at the bottom of the screen. Press the **RECORD** button again to display information about the current recording.
- Press the **STOP** button to display a dialogue box: select Yes to stop recording, select No to dismiss the dialogue box.

To watch a recorded program:

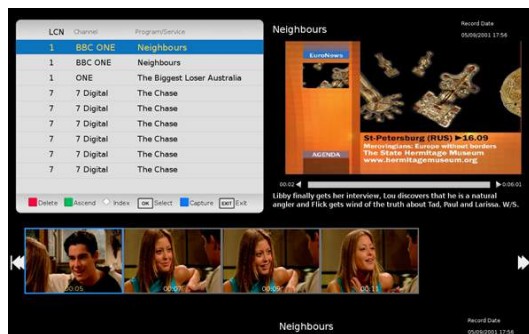

- Press the **INDEX** button on the remote control to display the PVR Settings page. (Alternatively, go to the Menu > PVR > Recorded List.)
- Use the **▲/▼** buttons to select a recorded file and press **OK** to start playback in full screen mode.

Scheduled Recording (in DTV mode only)

See instructions under EPG on the previous page.

Recording (Cont.)

Time-shift recording and playback (in DTV mode only)

IMPORTANT!

Before you can record with this TV set (including time-shift recording), you must have inserted a FAT32 formatted USB storage device into the USB port.

The time-shift function allows you to pause the live TV signal, then resume playback at your convenience.

- First, insert your USB memory device into the USB port.

When watching a program in DTV mode:

- Press the **▶||** button on the remote control to initiate time-shift mode and pause the program; the tool bar pictured below will appear on the screen.
- Press the **▶||** button again to resume playback.



- Use the **◀/▶** keys, then press OK to select a function such as Fast Forward from the on-screen toolbar.
- To stop time-shift, press the **■** STOP button on the remote control to display a dialogue box, then select Yes to exit time-shift mode and return to live TV signal, or select No to dismiss the dialogue box.

NOTE: The USB storage device will not retain recorded data after exiting the time-shift function

Recording (Cont.)

Important notes

When using the USB/Media function, remember the following important points:

- We strongly recommend you back up all data in the USB storage device to another storage device so you do not risk losing any data in case of an unexpected device failure or accident. **We do not assume liability for any loss of data due to misuse or malfunction. Data backup is your personal responsibility.**
- **You cannot change to a channel from another broadcaster or select another function while in recording mode.**
- If the signal is interrupted or removed while in recording mode, the recording will stop until the signal is established. This may cause you to lose program content.
- **Do not turn the TV off during recording, otherwise the TV will exit the time-shift function and turn to standby mode.**
- The file recorded can only be used in this TV. Do not copy it to any other device.
- When you are in time-shift recording mode, you may experience some difficulty with a scheduled recording at different times without removing the USB recording device. You will need to remove the USB device as it is required to reset after each recording to protect the device from damage. If you see the message 'DISK NOT READY' displayed, remove the device, reconnect and proceed with your recording.
- Some USB storage devices may not be compatible for smooth operation with this TV.
- For large file sizes and large capacity storage devices, the loading speed may be longer. The recognition speed of a USB storage device may vary depending on the device.
- When connecting or disconnecting the USB storage device, ensure the TV is not in USB mode, otherwise the USB device or the files stored in it may be damaged.
- Only use a USB storage device formatted in a FAT32 file system provided with the Windows operating system. If it is formatted by a different utility program that is not supported by Windows, it may not be recognised.
- Ensure any USB devices connected to the TV do not use/exceed 500mA power rating.
- If an "Unsupported File" message is displayed, the file format or codec is unsupported or corrupted.

Smart Hub

Press the SMART HUB key on the remote control, you can run the apps installed, access input sources and menu options. Press [LEFT]/[RIGHT]/[UP]/[DOWN] to select these functions



Smart TV applications

- AccuWeather
- Web Browser
- YouTube
- Facebook
- Twitter
- Picasa
- TerraTV

Input Source Options

(* Available options may change depending on the TV model)

- DTV
- ATV
- AV
- YPBPR
- PC
- HDMI 1/2/3
- USB (MEDIA)
- Miracast
- Hyperlink

After Sales Support

Telephone: 1300 886 649
Email: info@tempoaustralia.com.au

Smart Hub

Quick Links

- Recording – access the list of recorded programs (USB hard disk must be connected)
- Settings – access TV general menu settings
- Movie – access the movie player in MEDIA mode
- Photo – access the photo player in MEDIA mode
- Music – access the music player in MEDIA mode
- Channel – access TV channel menu settings
- Program List – access the channel list
- Picture – access the picture menu settings
- TV Guide – access Electronic Program Guide (EPG)
- Sound – access the sound menu settings

Miracast

Miracast feature enables you to echo the display from a compatible device like a smartphone or tablet on the TV screen by connecting your mobile device directly to the TV wirelessly. In order to use this feature, your device must support Wi-Fi Display technology.

- To start using Miracast feature, go to SMART HUB and press OK on MIRACAST.
- Turn on Wireless Display (a.k.a. Wi-Fi Display, Wi-Fi Direct, Cast Screen) function on your smart phone or tablet (Please refer to your device's user manual for information on how to turn on wireless display).
- Your mobile device will display a list of available devices. Choose 'My TV-My TV' click on it to connect. If the mobile device prompts for a password, enter HITACHI.
- Your mobile device will connect to the TV and will display the device screen on the TV.

Smart Hub

Hyperlink

Hyperlink feature allows you to share media files on your DLNA-enabled media PC, smart phone or tablet on the TV.

- In order to use this function, your shared media PC or smart device and the TV must be on the same network. Also your device must have built-in media share capability or have a third-party DLNA/UPnP media server installed.
- To start using Hyperlink feature, start the DLNA/UPnP media server on your device.
- Start HYPERLINK application on TV from the SMART HUB page.
- TV will automatically connect to shared media device. To choose a different device, press the RED button. A list of available devices will be displayed.
- Select your preferred media device from the list and click OK.
- Then select from either Movie, Music or Photo and press OK to enter it. You will only see supported media files under each category.
- Select the files you want to play and press PLAY button.

FreeviewPlus

FreeviewPlus is a new service provided by most of the free-to-air broadcast networks to enable you access Catch Up services on the TV. In order to access FreeviewPlus interactive applications, you are required to have a good broadband connection.

Once you're connected to the internet, press the;

- **GREEN** button on your remote to launch FreeviewPlus.
- **RED** button on your remote to launch broadcast network content and services.

Then follow the on-screen instructions to navigate through the applications.

NOTE:

- Your home network must have broadband Internet access. Contact your ISP if you have problems maintaining a fast connection that is reliable.
- Accessing Internet content may incur access or data fees from third parties such as your Internet service provider (ISP).
- Since all content is downloaded over the internet, there may be delay in loading the content.
- If any of your other network connected devices such as computers, gaming consoles and network hard drives are transferring large amounts of data across your network (such as a file transfer, online gaming, or other instances of streaming video), loading times of interactive applications, sound and picture quality may be compromised.

To turn off FreeviewPlus, go to SMART HUB > Channels and set HbbTV setting to OFF.

Media Mode

Media playback

- First, insert a USB memory device into the USB port.
- Press the SOURCE button on the back panel, or on the remote control, to switch the unit to MEDIA mode.
- Press the ▲ / ▼ / ◀ / ▶ buttons to move the cursor.
- Press the EXIT button to return to the previous menu page.
- * Press the  RED button to change the device.

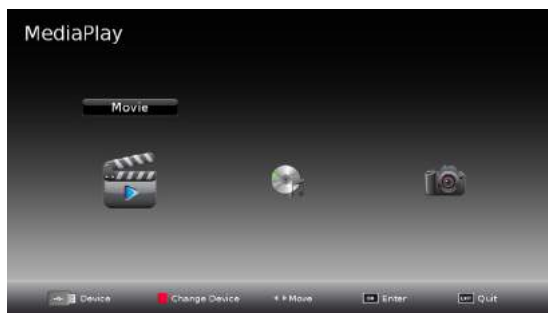

Photo

- Press the ◀ / ▶ buttons to select Photo in the main menu, then press OK to enter it. Photos files can only be played in this menu category.
- Use the ▲ / ▼ / ◀ / ▶ buttons to select the desired folder or file, then press OK to select files and press  button to play files fullscreen.

When playing photo files:

- Press the MENU button on the remote control to hide/display the on-screen tool bar.



- * Use the ◀ / ▶ keys, then press OK to select a function such as Previous, Next, Rotate, Enlarge from the on-screen toolbar
- * Press STOP or EXIT buttons to exit playback & go back to file list page.

Media Mode

Music

- Press the ◀ / ▶ buttons to select Music in the main menu, then press OK to enter it. Music files can only be played in this menu category.
- Use the ▲ / ▼ / ◀ / ▶ buttons to navigate to the desired folder or file, then press OK to select and press ▶| PLAY button for playback.



When playing music files:

- Use the ◀ / ▶ buttons, then press OK to select a function such as NEXT, FAST FORWARD and STOP from the on-screen toolbar.

Media Mode

Movie

- Press the ◀ / ▶ buttons to select Movie in the menu, then press OK to enter. Movie files can only be played in this menu category.
- Use the ▲ / ▼ / ◀ / ▶ buttons to navigate to the folder or file, then press OK to select and press ► PLAY button for playback.

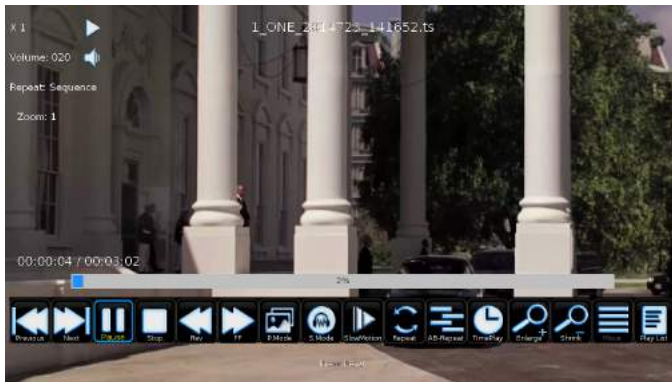

When playing movie files:

- Press the MENU button on the remote control to hide/display the tool bar.
- Press the ◀ / ▶ buttons to select the preferred function, then press OK to confirm.

Remote operations when playing multimedia files:

- Press the ►|| button to play or pause playing.
- Press the ■ button to stop playing.
- Press the ◀◀ button to move fast backward.
- Press the ▶▶ button to move fast forward.
- Press the ◀◀◀ button to play the previous file.
- Press the ▶▶▶ button to play the next file.

NOTE: To play your multimedia files, make sure you have selected the correct icon in the main media playback menu.

Media mode

This TV set contains different settings menus where you can program your preferred settings. Once you have programmed any settings, the unit will retain them in its memory until you change them, even when switching the unit to standby mode. This means you can always operate the system under the same conditions.

Menu navigation

- Press the MENU button on the back panel, or on the remote control, to display the main menu.
- Press the ◀/▶ buttons to select different submenus.
- Press OK or ► to enter the submenu page.
- Press the ▲/▼ buttons to select the preferred option.
- Press the ◀/▶ buttons to adjust the value.
- Press the MENU button to return to the previous menu page.
- Press the EXIT button to exit the menu page.

Menus

Time

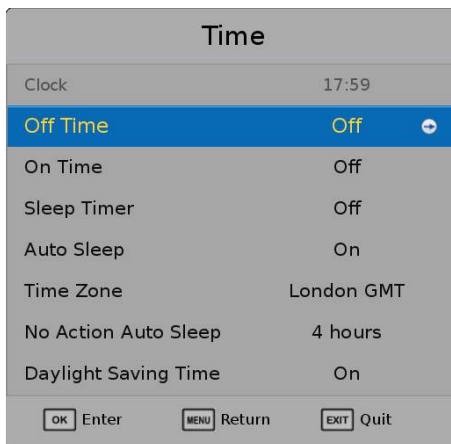

Function explanation:

Item	Support mode	Explanation
Clock	Hour:Min	It shows current time information.
Off Time	Off->Once->Everyday ->Mon~Fri ->Mon~Sat ->Sat~Sun->Sunday	Set off time. You can set the Hour and Minute
On Time	Off->Once->Everyday ->Mon~Fri ->Mon~Sat ->Sat~Sun->Sunday	Set On time. You can set Hour、Minute、Source、Channel、Volume
Sleep Timer	Off > 10 min > 20 min > 30 min > 60 min > 90 min > 120 min > 180 min > 240 min	
Auto Sleep	On/Off	TV will go into standby in 10 min if there is no signal coming in or no operation. In "PC" mode, auto sleep timer is 1 minute.
Time Zone		Select your time zone
No Action Auto Sleep	Off > 1 hour > 2 hour > 3 hour / 4 hour	TV will go into standby if there is no operation.
Daylight Saving Time	On/ Off	

Menus

Lock

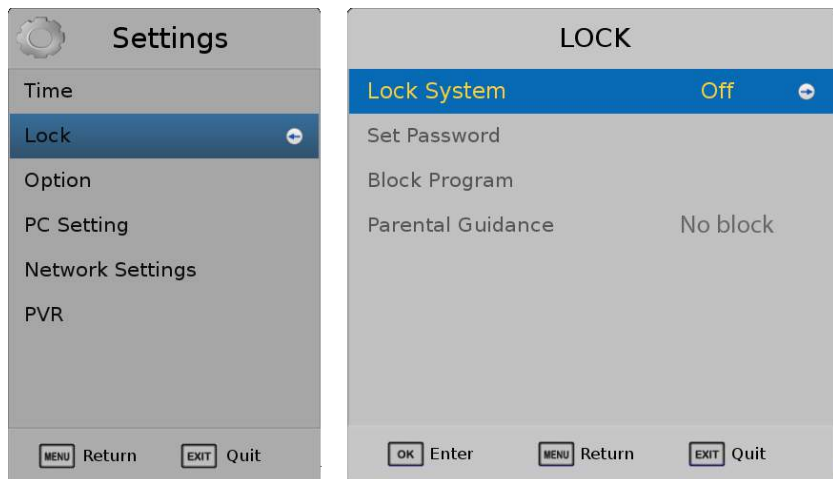

Function explanation

Item	Support mode	Explanation
Lock System	On/Off	You need to input password to enter submenu , the password default is 0000
Set Password		Set personal password
Block Program		Press green (LOCK), then there is LOCK icon on this selected channel, and the channel is locked
Parental Guidance	No Block/ Block G and above Block PG and above Block M and above Block MA and above Block AV and above Block R and above Block all	Set parental guidance

Menus

Hotel Lock	Hotel Lock	Turn Hotel lock function on/off
	Lock sources	Turn off the input sources
	Default sources	Set default source
	Max Volume	Set maximum volume level
	Default volume	Set default volume level
	Default channel	Set default channel when default source is set to DTV
	Export settings	Export all hotel lock settings to USB drive
	Import settings	Import hotel lock settings from USB drive
Lock Keypad		Turn on/off the functionalities of the keypad on rear panel

Menus

Option

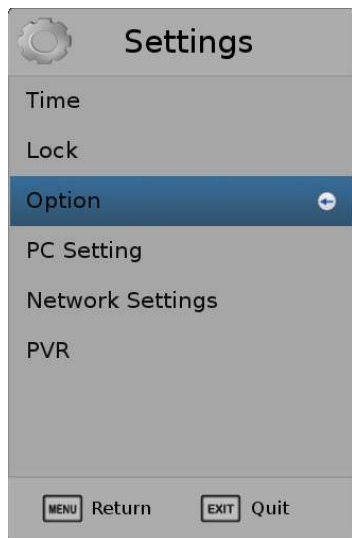

Function explanation

Item	Support mode	Explanation
OSD Language	English, Spanish, French ,Italian, Portugues, German,	Select On Screen Display(OSD) language.
Primary audio Language		Select primary audio language (only available in DTV mode).
Secondary Audio Language		Select secondary audio language (only avail able in DTV mode).
Primary subtitle Language		Select primary subtitle language (only available in DTV mode and must be supported by viewing program).
Secondary Subtitle Language		Select primary subtitle language (only available in DTV mode and must be supported by viewing program).
Hearing Impaired	On/Off	
HDMI CEC	HDMI CEC/Auto turn off /ARC	
Restore to Default		Reset all settings to factory defaults

After Sales Support

Telephone: 1300 886 649
 Email: info@tempoaustralia.com.au

Menus

Network Setting

For a stable internet connection, it is recommended to use a wired connection or place the wireless router close to the TV.

Wired

For Wired network connection, make sure to connect the TV to your internet router using RJ45 Ethernet cable before starting the setup process.

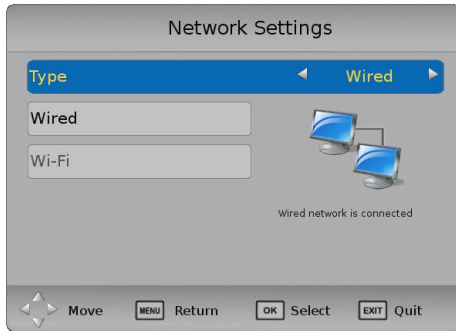

Press ◀/▶ keys and select “wired” network type. The press ▼ to highlight “wired”, press ok and bellow screen will appear.

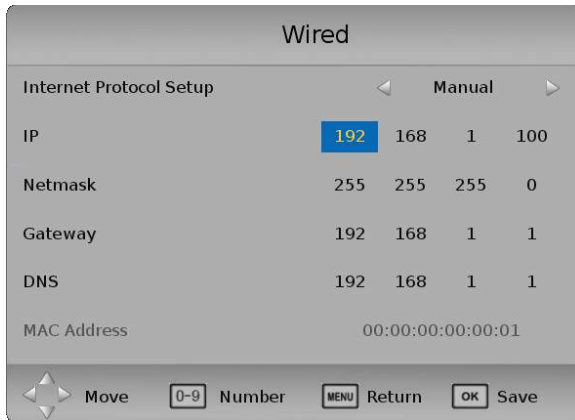

Menus

Function explanation:

Item	Format	Explanation
Internet Protocol Setup	Manual/Auto	Manually set the IP information of the wireless network, or automatically acquire IP information of wireless network.
IP	xxx.xxx.xxx.xxx	Under "Manual " setup enter the IP address using the numerical keypad.
Netmask	xxx.xxx.xxx.xxx	Under "Manual " setup enter the Netmask address using the numerical keypad.
Gateway	xxx.xxx.xxx.xxx	Under "Manual " setup enter the Gateway address using the numerical keypad.
DNS	xxx.xxx.xxx.xxx	Under "Manual " setup enter the DNS address using the numerical keypad.
MAC Address	----	MAC address of the TV

Press OK to save the settings. If the connection is successful , the 'Wired network is connected' message will appear. Press Exit button to exit the menu.

If the connection is unsuccessful, the 'Wired network is not connected' message will appear. Check the accuracy of information you have entered and try again.

Menus

Wi-Fi

For 'Wi-Fi Network Connection', make sure to place your Wi-Fi Router close to the TV



Press ◀/▶ key and select 'Wi-Fi' network type. Then press ▶ to highlight 'Wi-Fi', press OK and below screen will appear.

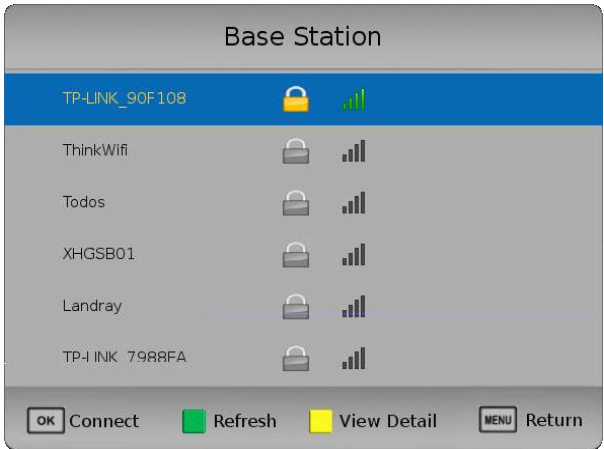

Menus

For advanced ‘Wi-Fi network’ settings, navigate to MENU > NETWORK SETTINGS > Wi-Fi > SELECT YOUR WAP (You must be successfully conected), and press  BLUE button. Following screen will appear.

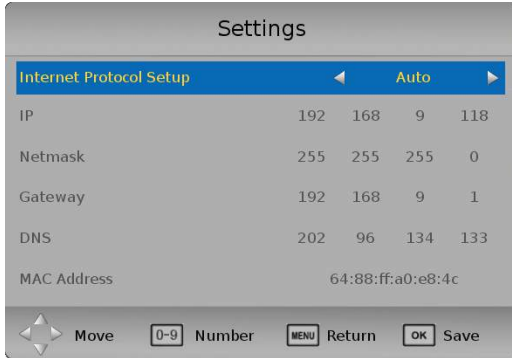





Function explanation:

Item	Format	Explanation
Internet Protocol Setup	Manual/Auto	Manually set the IP information of the wireless network, or automatically acquire IP information of wireless network.
IP	xxx.xxx.xxx.xxx	Under “Manual ” setup enter the IP address using the numerical keypad.
Netmask	xxx.xxx.xxx.xxx	Under “Manual ” setup enter the Netmask address using the numerical keypad.
Gateway	xxx.xxx.xxx.xxx	Under “Manual ” setup enter the Gateway address using the numerical keypad.
DNS	xxx.xxx.xxx.xxx	Under “Manual ” setup enter the DNS address using the numerical keypad.
MAC Address	----	MAC address of the TV

Press OK to save the settings. Enter the WAP password correctly using the on-screen keypad and press connect. click OK to exit.

Menus

The TV will automatically begin searching for nearby Wi-Fi access Points (WAP). This may take up to 2 minutes. If your WAP doesn't appear, move your Wi-Fi router closer to the TV and press  GREEN button to search again.

Select the WAP you wish to use by pressing   button to view detailed information, press  YELLOW button.

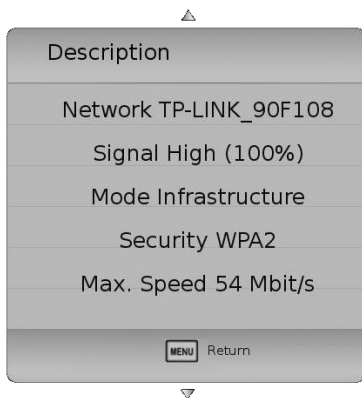

After selecting the WAP, press OK. If the WAP has a security password, enter the password using on-screen keypad. and the press CONNECT.



Menus

If the connection is successful , the 'Internet Connected Successfully!' message will appears. Click OK to exit.

If the connection is unsuccessful, Click the security password of your WAP and its security protocal settings and try again

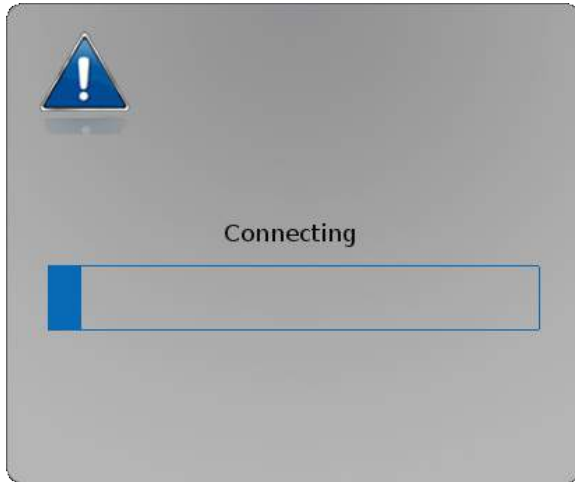

Menus

PVR Menu Settings

- Recorded List - Shows the list of recorded programs (you can also use the INDEX key on the remote to access this page)

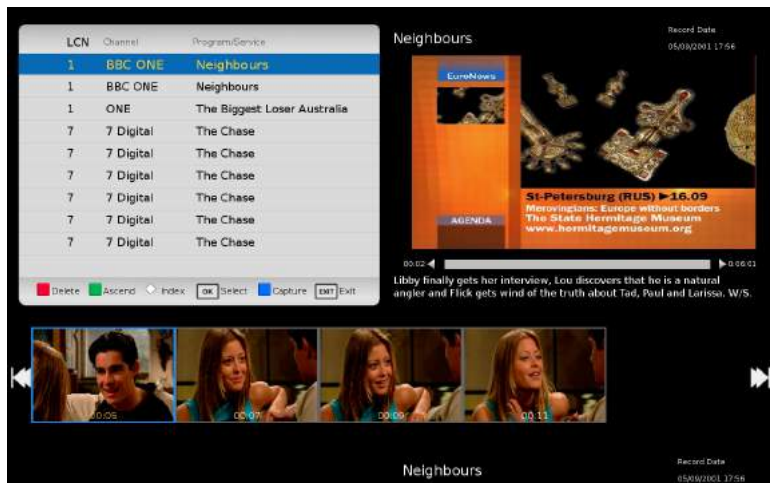

- **Record** – schedule a program to be recorded.



Menus

- **Remind** – Schedule a reminder to watch your favourite program
- **Schedule List** – Shows the list of programs scheduled to be recorded

Mode	Time	Date	Programme Title	Channel Name
	18:59	Wed. 05 09 2001		BBC ONE

- **PVR File System**

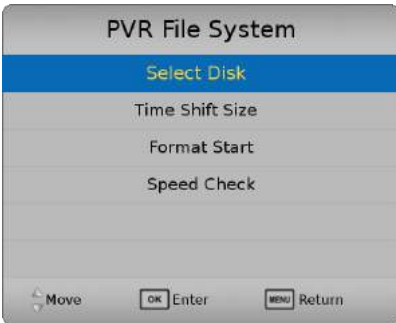

Select Disk



If you have multiple partitions on your disk, select the partition you wish to use.



Menus

•Time Shift size



Press left/right buttons and change the size of the time shift buffer.

•Format start

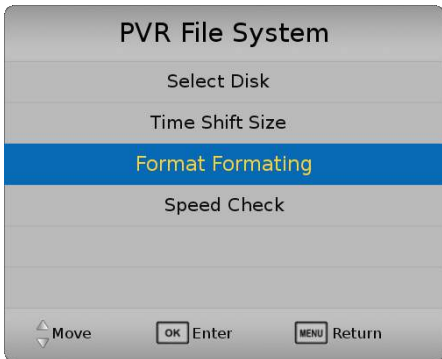

Press OK and confirm to format your USB drive

•Speed Check

Press OK to check the speed of the USB drive

Menus

Channel Menu Settings

To access Channel menu, navigate to SMART HUB > Channel.
The password default is 0000.



Auto Tuning

Press OK to enter. Then select your country, tuner type, LCN and press OK to start scanning.

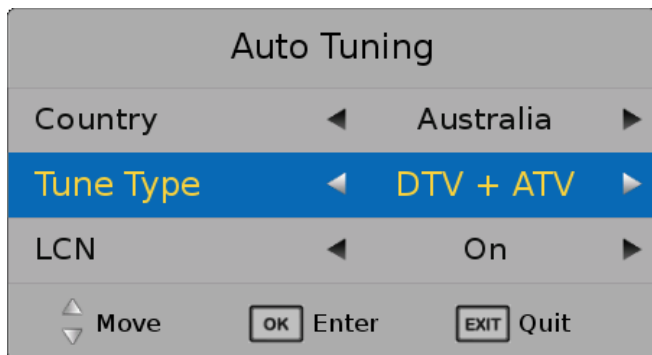

Menus

DTV Channel Tuning

Press OK to enter. Press left/right to select the channel. Press OK to start scanning.

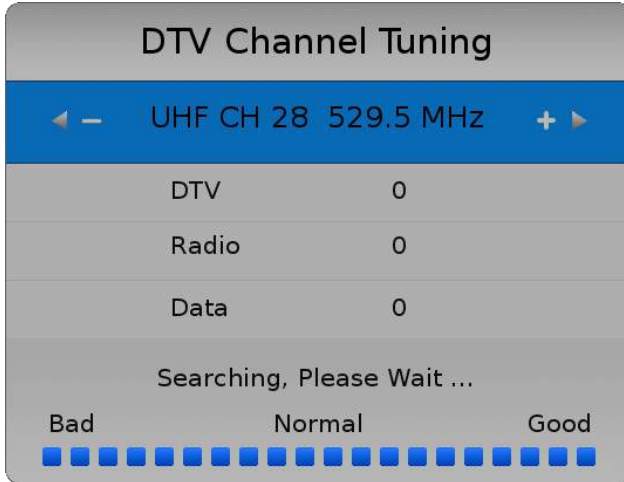

Menus

Program Edit

Press OK to enter.

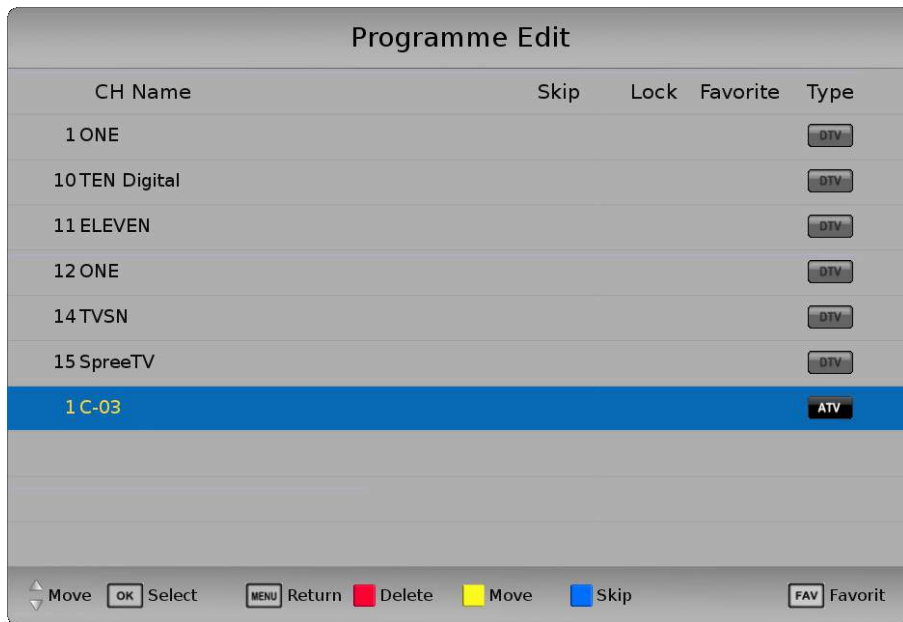

- Press RED button delete a channel from the channel list and EPG
- Press BLUE button to skip a channel when using CH+/- buttons
- Press FAV to add a channel to Favourites List; press the button again to remove from the Favourites List.

HbbTV

Turn on/off HbbTV (FreeviewPlus).

Menus

Signal Information

- This item is used to display signal details, such as Channel Number, Frequency, Quality and Strength.

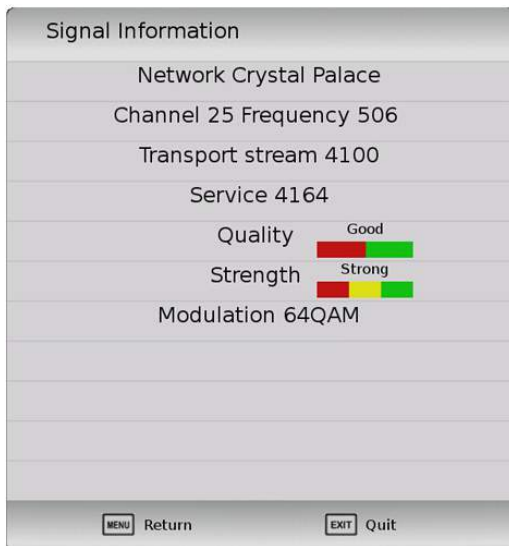

Software Update (USB)

- This item is used to update software through USB memory device.

Menus

Setting

Picture Menu Settings:

To access the picture menu, navigate to SMART HUB > Picture.

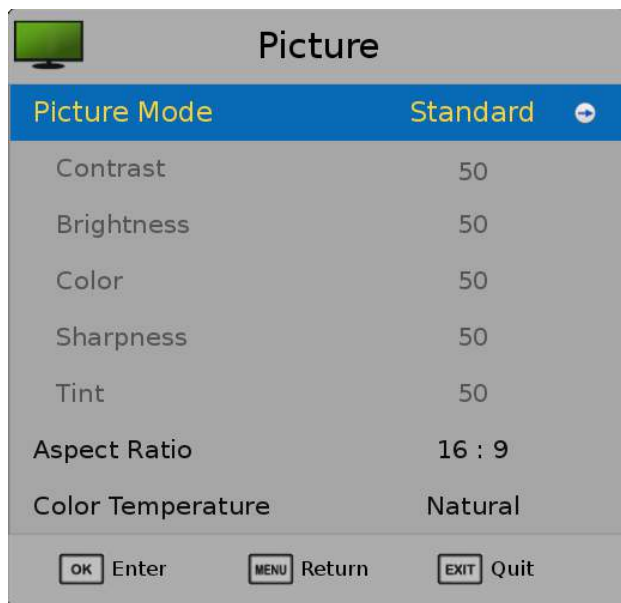

Function explanation:

Item	Support mode	Explanation
Picture Mode	Standard > Movie > user > Eco > Dynamic	Picture mode selection. When "user" setting is selected contrast, Brightness, Colour, Sharpness. settings can be adjusted
Aspect Ratio	Auto > 4:3 > 16:9 > Zoom 1 > Wide Zoom > Panorama	Adjust the picture size
Color Temperature	Natural > Warm > Cool	Color Temperature selection
Noise Reduction	Off > Low > Middle > High	
Back light	0 - 100	Adjust backlight intensity

Menus

Sound:

To access the sound menu, navigate to SMART HUB > SOUND

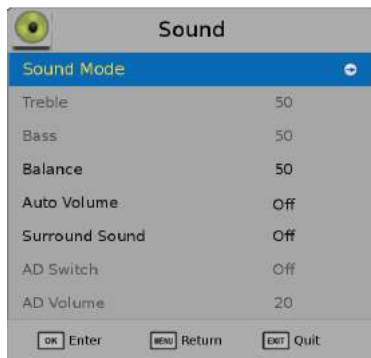

Function explanation:

Item	Support mode	Explanation
Sound Mode	Standard -> Music -> Movie -> Sports -> User	When "user" setting is selected, you can adjust EQ settings as well as Treble and Bass settings.
Balance	(-)50—(+)50	Adjust the audio output between left and right speakers.
Auto Volume	On/Off	Auto volume on/off
Surround Sound	On/Off	Turn Surround sound Simulation on or off.
AD Switch (Audio Description)	On/Off	Audio description for visual representation works only with programs that contain related narration information (for people with vision impairments).
AD Volume	0-100	Only AD Switch is set "on", can it be adjusted
S/PDIF Mode	PCM/Auto	Select the digital audio output type
Audio Language		Displays audio codec information for current program.

FAQs

If you experience any problems with your TV, check the list below and take any necessary steps before calling for service. If none of the solutions help you solve the problem, turn the power off and contact the after sales support line for advice.

General problems with the TV set

Problem	Solution
No power.	Insert the power plug securely into the power outlet.
No picture.	Ensure that the equipment is connected properly. <ul style="list-style-type: none">• Adjust the antenna or use an external antenna.• Relocate the unit near a window (if inside a building).• Move the TV set away from any product that causes interference.• Auto-tune the unit again.• Try another channel.
No sound or distorted sound.	<ul style="list-style-type: none">• Ensure that the equipment is connected properly.• Ensure that the input setting for the TV is correct.• Ensure the audio settings are properly set.• Ensure the volume is not muted. If it is, press the MUTE button to restore the sound.• If earphones are connected, unplug them.• Adjust the volume to a suitable level by pressing the VOL+/VOL- button.
No operations can be performed with the remote control unit.	<ul style="list-style-type: none">• Check the batteries are correctly installed.• The batteries may be exhausted: replace them.• Make sure to point the remote control at the remote control sensor and try it again.• Make sure to use the remote control at a distance of no more than 6m from the sensor.• Remove any obstacles between the remote control and remote control sensor.
No key operation (by the main unit and/or the remote control) is effective.	Disconnect the power plug and then reconnect it. (The unit may not be operating properly due to lightning, static electricity or some other factors.)
Noise or other interface	Electronic equipment near the unit is causing interface. Relocate the unit or move the equipment.

After Sales Support

Telephone: 1300 886 649
Email: info@tempoaustralia.com.au

FAQs (Cont.)

Problem	Solution
Play does not start, even when title is selected.	<ul style="list-style-type: none">• Confirm the region code setting is correct.
No subtitles are displayed.	<ul style="list-style-type: none">• Subtitles appear only with discs that contain them. Check whether your DVD has subtitles.• Make sure to select Subtitles ON in the settings, otherwise they will not be displayed.
Audio soundtrack and/or subtitle language is not as per the initial settings.	<ul style="list-style-type: none">• If the audio soundtrack and/or subtitle language does not exist on the disc, the language selected at the initial settings will not be seen/heard.
Alternative audio soundtrack (or subtitle) languages cannot be selected.	<ul style="list-style-type: none">• Alternative languages can only be selected on discs that contain more than one language. Check and ensure your disc has more than one language.• With some DVDs, an alternative language cannot be selected with the LANG or SUBTITLE button. Try selecting it from the DVD menu, if an alternative language is available.
Angle cannot be changed.	<ul style="list-style-type: none">• This function is dependent on software availability. Even if a disc has a number of angles recorded, they may be recorded for specific scenes only.
No menu play (with video CDs)	<ul style="list-style-type: none">• This function works only for video CDs with playback control.

Problems relating to the USB device

Problem	Solution
My TV does not recognise my USB device or my external hard disk.	<p>Please refer first to the instructions describing how to use USB devices with this unit.</p> <p>If the problem still occurs, your device may not be compatible. This machine has been tested with the majority of Flash memory-based devices and hard disks (Music/Movie players with HDD) on the market; however, it may not be compatible with certain devices, in particular external self-powered hard disks.</p>

Maintenance and Recycling

Maintenance

Early malfunctions can be prevented. Careful and regular cleaning can extend the amount of time you will have your new TV. Be sure to turn the power off and unplug the power cord before you begin any cleaning.

Cleaning the screen

1. Here's a great way to keep the dust off your screen for a while. Wet a soft cloth in a mixture of lukewarm water and a little fabric softener or dish washing detergent. Wring the cloth until it's almost dry, and then used it to wipe the screen.

2. Make sure the excess water is off the screen, and then let it air-dry before you turn on your TV.

Cleaning the cabinet

To remove dirt or dust, wipe the cabinet with a soft , dry, lint-free cloth. Please be sure not to use a wet cloth.

Extended Absence

If you expect to leave your TV dormant for a long time (such as a vacation), it's a good idea to unplug the power cord to protect against possible damage from lightning or power surges.

Disposal of old electrical appliances



Correct Disposal of this product. This marking indicates that this product should not be disposed with other household wastes.

To prevent possible harm to the environment or human health from uncontrolled waste disposal, recycle it responsibly to promote the sustainable reuse of material resources. To return your used device, please use the return and collection systems or contact the retailer where the product was purchased. They can take this product for environmental safe recycling.

Specifications

Display Device	55" (139cm) FHD LED TV Display area: 1209.6 (H) x 680.4 (V)
ResolutionH	1920 x 1080
Pixel Pitch	0.630 (H) x 0.630 (V)
Luminance	250 cd/m ²
Contrast Ratio	1200 : 1
Aspect Ratio	16 : 9
Response Time	8ms
Viewing Angle	±85° max.
Multimedia Playback Format under TV Mode	avi, mpeg, mpeg 4, dat, mkv, vob, rmvb,rm
Operating temperature	5°C - 35°C
Power Source	100 - 240V~, 50/60Hz
Power Consumption	130 W
Dimensions (mm)	Unit: 1240.6 × 773.8 × 216.9 (with stand)
	Boxed: 1365 x 875 x 190
Weight	17.0 kg (with box)
	13.3 kg

Warranty

PRODUCT WARRANTY: IMPORTANT INFORMATION PLEASE READ CAREFULLY:

If your product is faulty or you are experiencing difficulties using this product and require assistance please call our customer assistance helpline as listed below:

Customer service helplines: 1300 886 649 (calling within Australia 8:30am - 5pm)
0800 836 761 (calling within NZ - 9am - 7pm)
Open Monday to Friday except on public holidays.

Distributed by: Tempo (Aust) Pty Ltd
PO Box 6056
Frenchs Forest DC 2086
Australia
Info@tempo.org

This product has been manufactured to the highest quality standards. This product is warranted to the original purchaser or gift recipient and is not transferable.

Warranty

The product is guaranteed to be free from defects in workmanship and parts for a period of 24 months from the date of purchase. Defects that occur within this warranty period, under normal use and care will be repaired, replaced or refunded with no charge for parts or labour.

The benefits conferred by this warranty are in addition to all other rights and remedies of the consumer under a Commonwealth, state and territory laws in relation to the goods or services to which this warranty relates.

Our goods come with guarantees that cannot be excluded under the Australian Consumer Law (Schedule 2 of the Competition and Consumer Act 2010 (Cth)). You are entitled to a replacement or refund for a major failure and compensation for any other reasonably foreseeable loss or damage. You are also entitled to have the goods repaired or replaced if the goods fail to be of acceptable quality and the failure does not amount to a major failure. If you require further information on the Australian Consumer Law, please visit the Australian Consumer Law website at <http://www.consumerlaw.gov.au>.

Goods presented for repair may be replaced by refurbished goods of the same type rather than being repaired. Refurbished parts may be used to repair the goods.

Proof of Purchase

This warranty is valid of the original purchase only and is not transferable. Please keep your purchase docket or receipt as proof of purchase and as proof of the date on which the purchase was made. The purchase docket or receipt must be presented with the warranty when making a claim under this warranty.

Service during the warranty period

The first point of contact for ALL product issues is the Tempo (Aust) Pty Ltd After Sales Support Centre Ph: 1300 886 649 (AUS) 0800 836 761 (NZ) . Customer must NOT take any product back to the store unless they have obtained a Return Authorisation (RA) number from our After Sales Support Team

After Sales Support

Telephone: 1300 886 649
Email: info@tempoaustralia.com.au

Warranty

- The product can be personally returned to the original place of purchase for product repair, replacement or refund. Please ensure the product is properly packaged so as to ensure, that no damage occurs to the product during transit. Also make sure that you have included an explanation of the problem.
- In the event of goods requiring repair under warranty, the owner is responsible for the cost of transportation. The product will be at owner's risk whilst in transit to or from the Tempo or Authorised Service Centres. Should the goods be found to be in sound working order the owner might be charged a fee.
- In the event of repair under warranty on goods more than 30km away from the place of purchase, additional travel costs will be billed to the owner.

Extent of Warranty

This warranty is limited to defects in workmanship or parts. All defective products or parts will be repaired, replaced or refunded. This warranty does not extend to accessories not supplied with the product or by Tempo. This warranty does not cover manuals and packaging. This warranty does not cover batteries or any other consumable item.

Normal Wear and Tear

This warranty does not cover normal wear and tear of the products or parts.

Exclusions

This warranty does not cover:

- Any defect caused by an accident, misuse, abuse, improper installation or operation, lack of reasonable care, unauthorised modification, loss of parts, tampering or attempted repair by a person not authorised by the distributor.
- Any product that has been damaged by a lightning strike either directly or indirectly or a main's power surge or liquid ingress.
- Any product that has not been installed, operated or maintained in accordance with the manufacturer's operating instructions provided with the product.
- Any product that has been used for purposes other than domestic use.
- If the product is located outside Australia.
- Any damage caused by improper matching of amplifier, improper power input or improper cable connection.

