

DENON

DBT-1713UD

UNIVERSAL AUDIO/VIDEO PLAYER

Getting Started

Mise en route / Antes de empezar

Welcome

Thank you for choosing a DENON player.
This guide provides step-by-step instructions for setting up your player.

If you have setup problems:

If you need additional help in solving problems, contact DENON customer service in your area.
See the address sheet included in the box.

1-855-MY.DENON

1-855-693-3666



Call for Assistance: 9:00AM to 8:00PM M-F E.S.T.

For frequency asked questions please visit www.usa.denon.com/FAQ.

For US and Canada only

Before You Begin

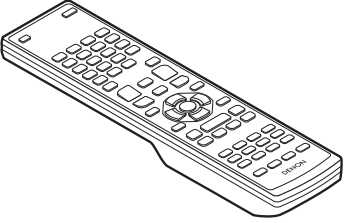
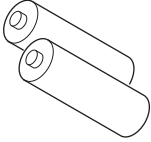
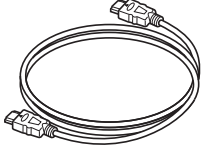
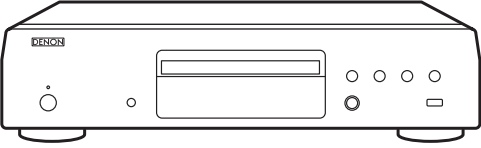
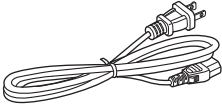
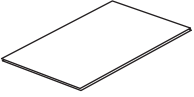
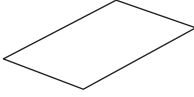
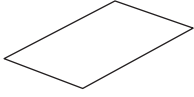
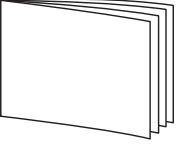
What's In the Box

| | | |
|---|---|--|
|  |  |  |
| Remote control unit | Batteries | HDMI cable |
|  |  | |
| Player | Power cord | |
|  |  |  |
| Warranty (for North America model only) | Service network list | Safety Instructions |
|  |  | |
| Getting Started | Owner's Manual | |

Required for setup

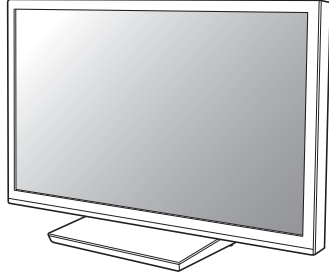
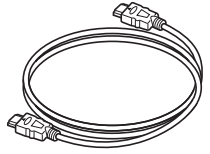
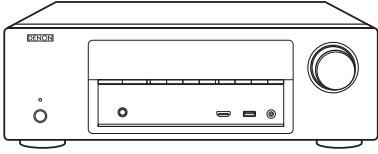
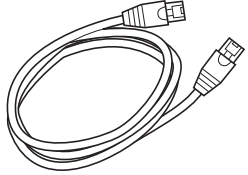
| | |
|---|---|
|  |  |
| TV | HDMI cable |
|  |  |
| Receiver | Ethernet cable |



Note that the illustrations in this manual is for explanation purposes and may differ from the actual unit.

Setup Steps

There are five steps to the setup process.

1 Install batteries in the remote control unit

2 Connect the player to your device

3 Turn on the power

4 Insert the disc and begin playback

5 Playback of Internet content

1 Install batteries in the remote control unit

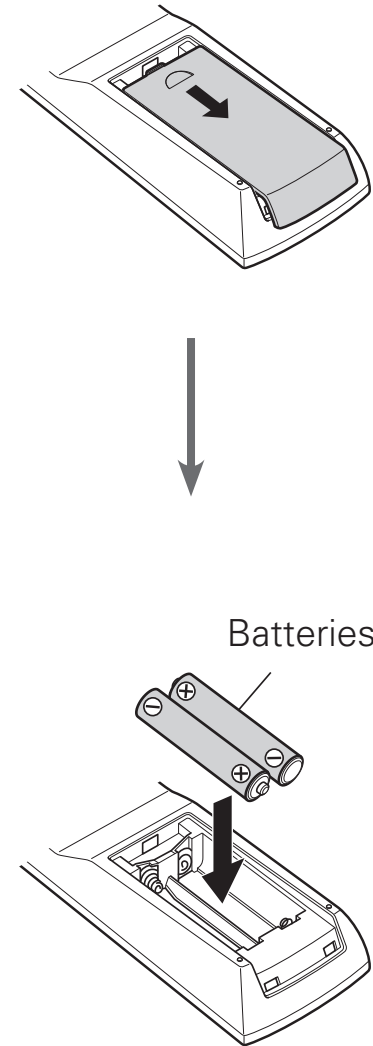

2 Connect the player to your device

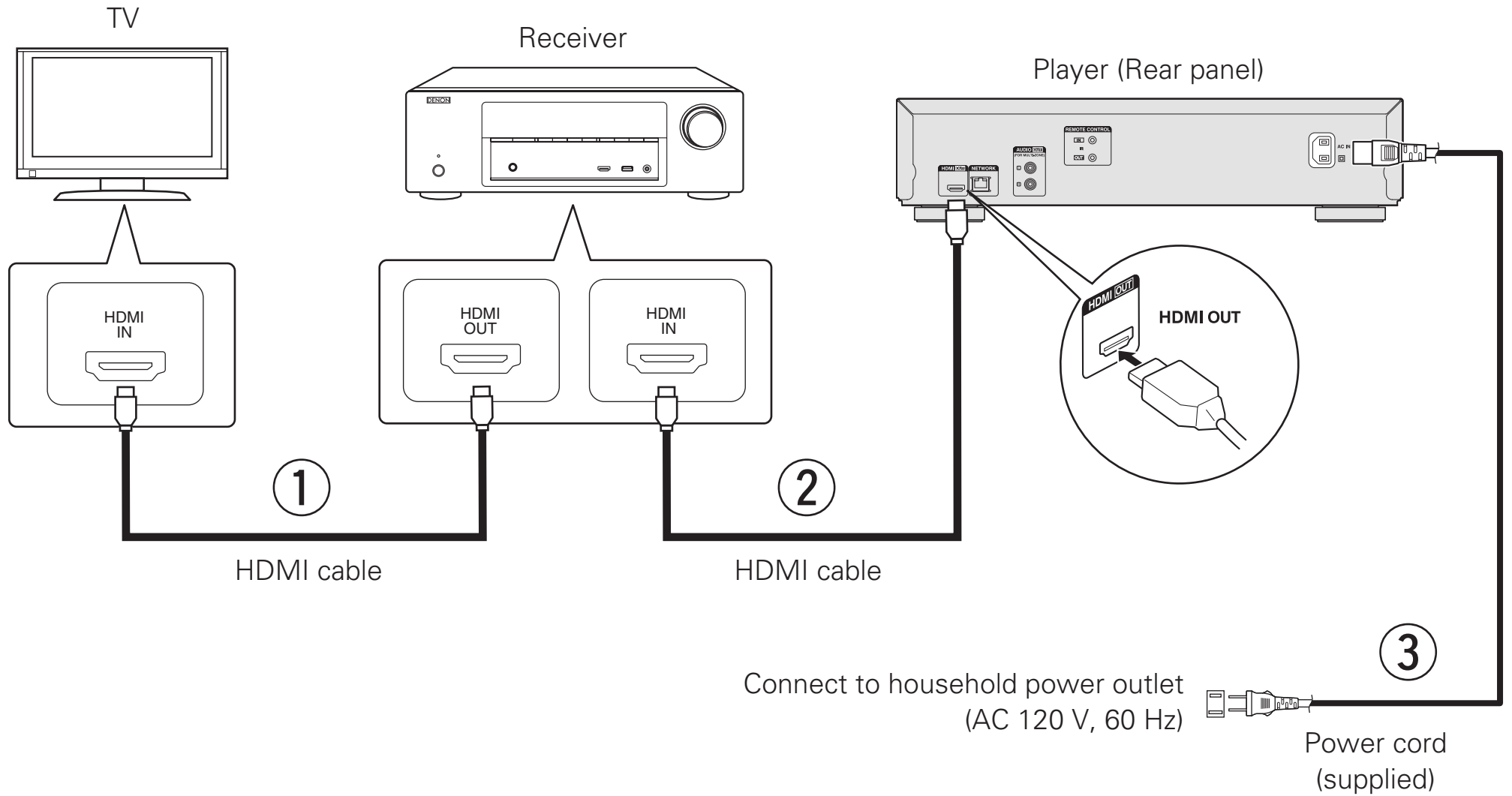

3 Turn on the power

1 Turn on player.

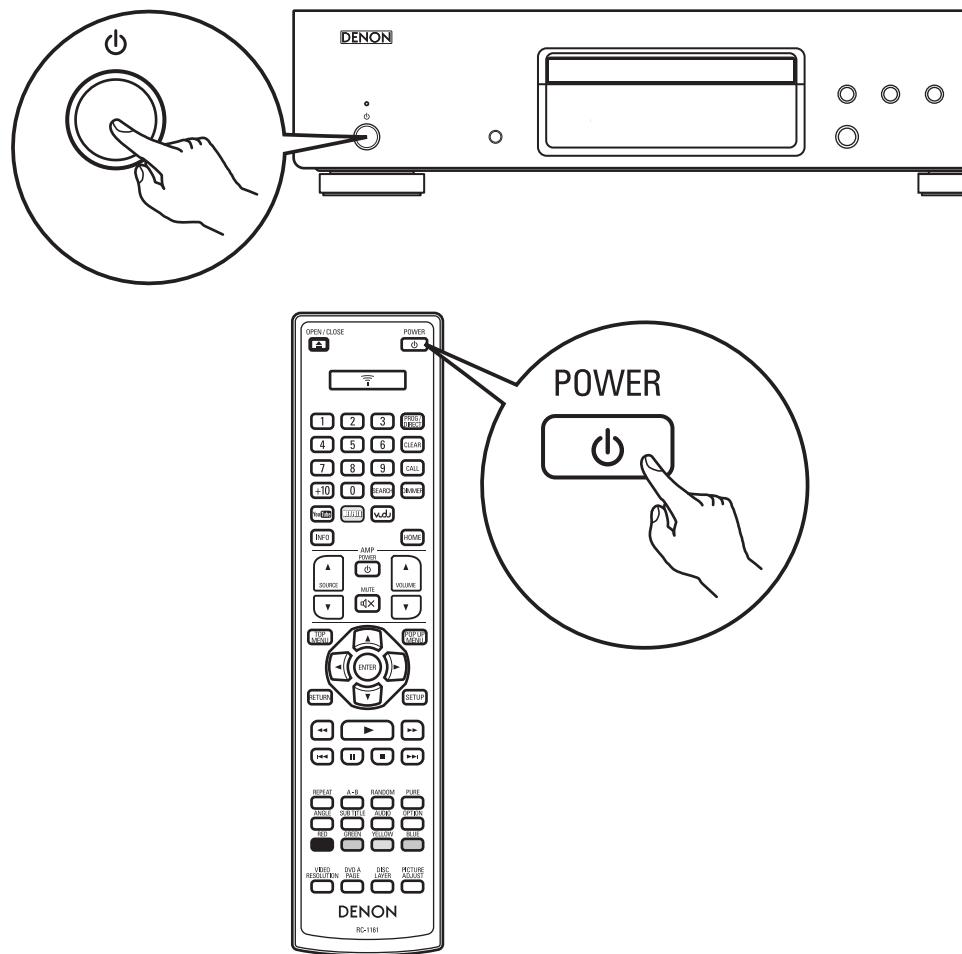

2 Turn on receiver.

Select the appropriate HDMI input on your receiver.

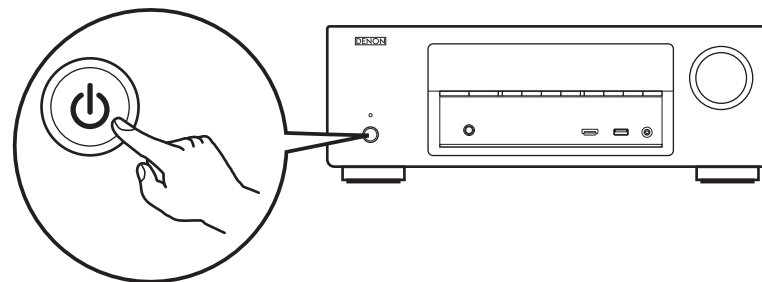

3 Turn on the TV.

Select the appropriate HDMI input on your TV.

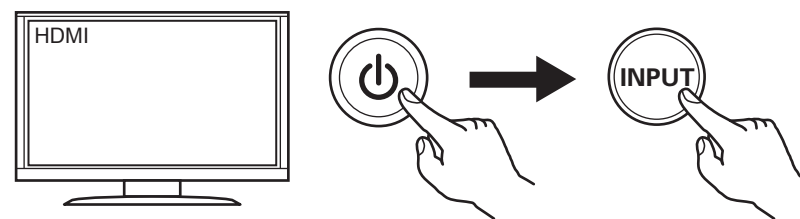

TV remote control unit

4 Insert the disc and begin playback

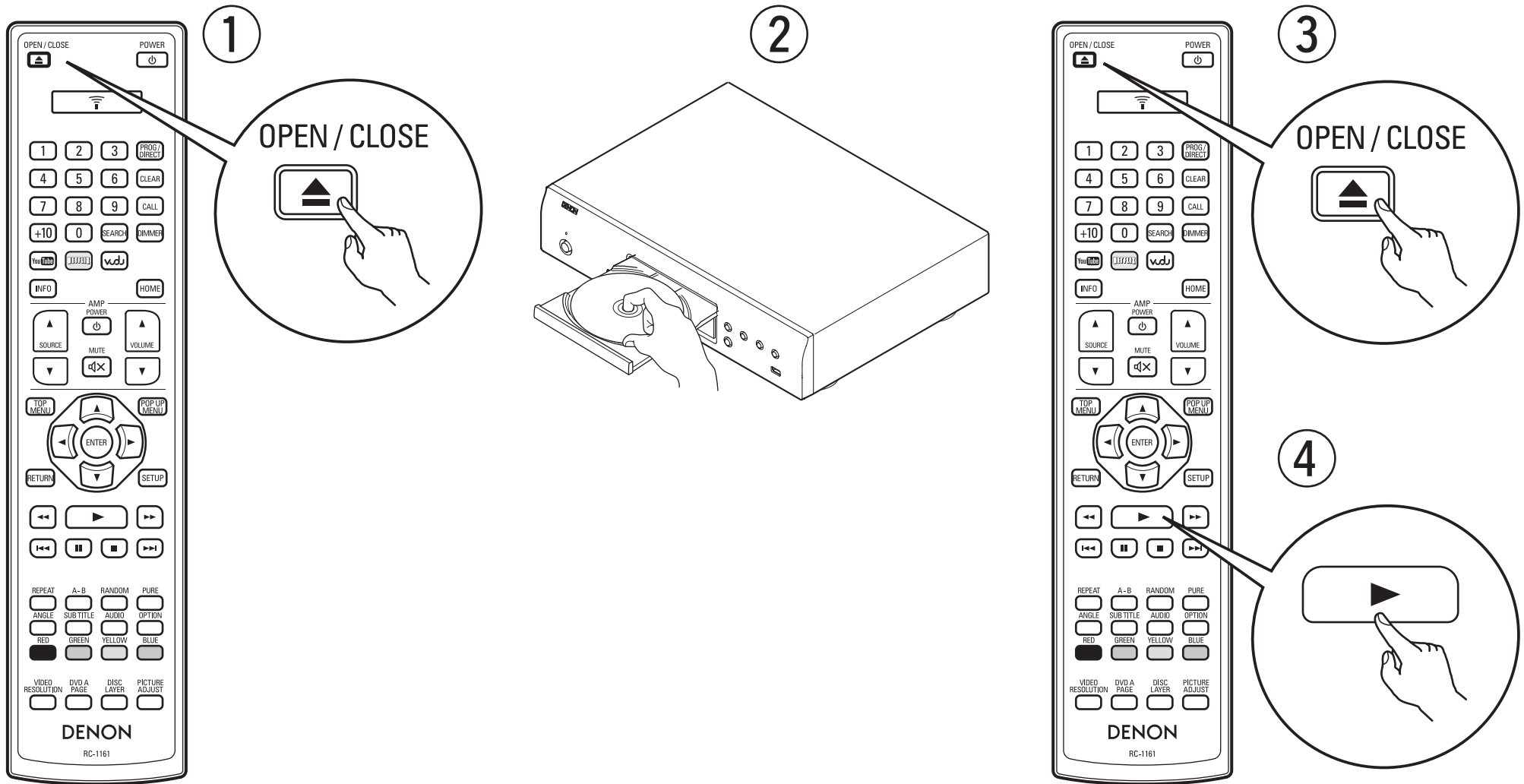

5 Playback of Internet content

① Network connection

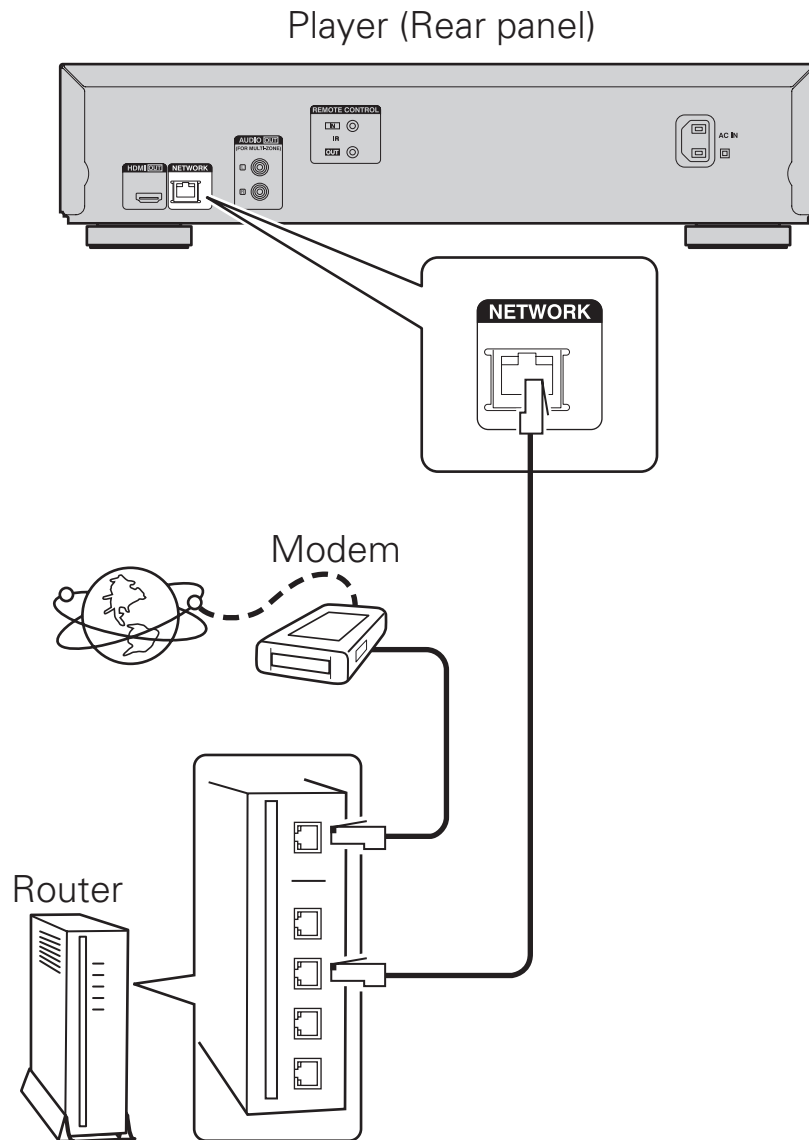

② Playback

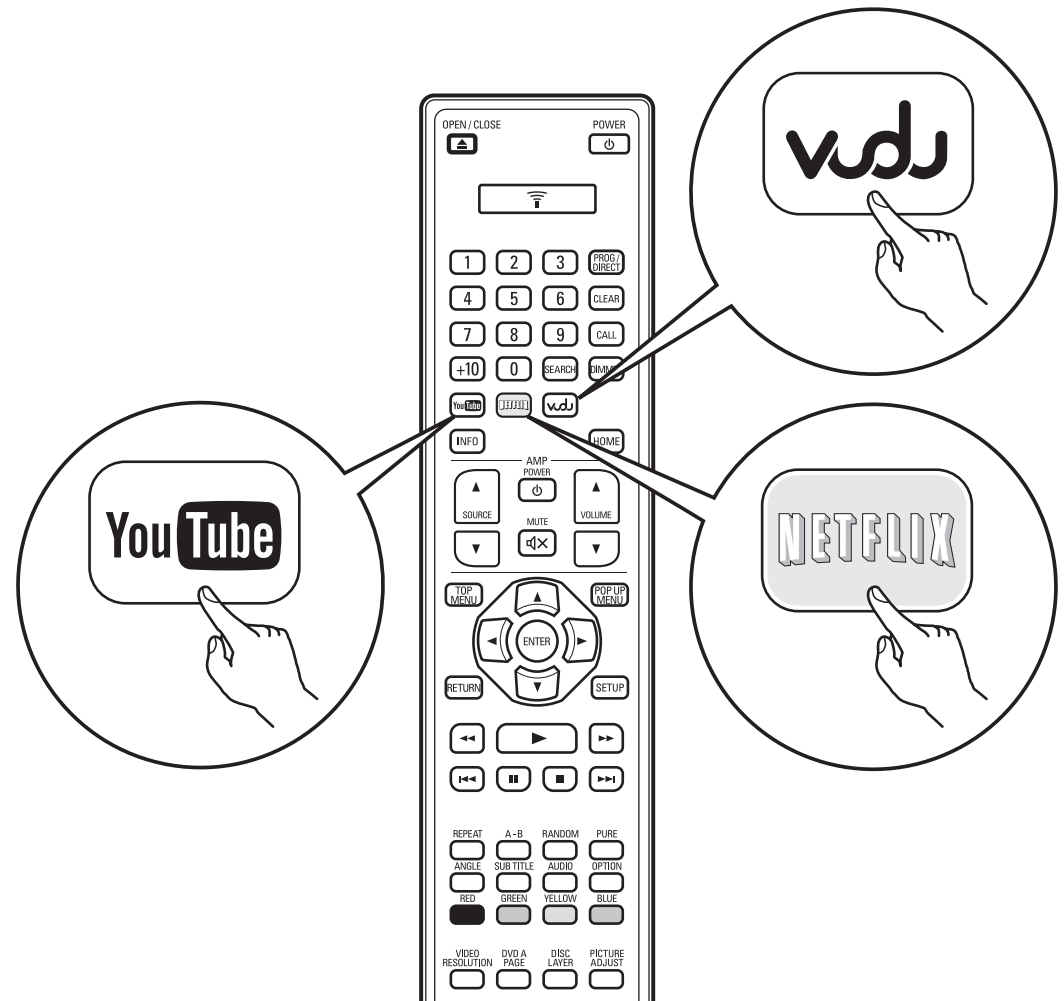

Owner's Manual

The included CD-ROM contains an Adobe PDF version of the full owner's manual for the player.
Please reference this manual for more details about the setup and operation of the player and its features.

NOTE

The contents of the included CD-ROM cannot be viewed using this player.

1 Insert the disc into your PC.

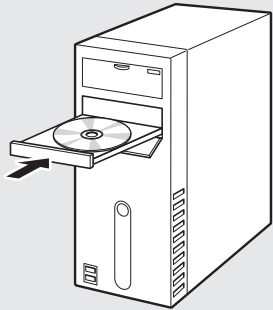

2 Follow the screen or double click on the PDF file.

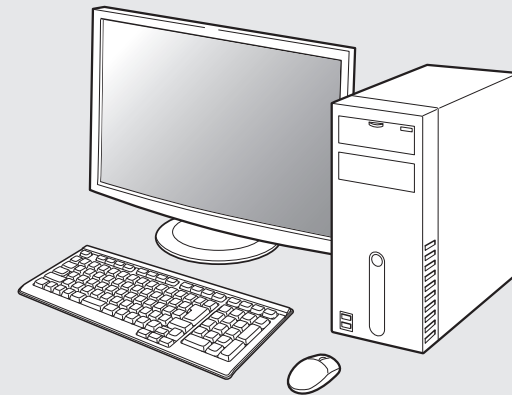

V00

DENON
www.denon.com

D&M Holdings Inc.
Printed in China 5411 10849 00AD

