

INSTRUCTION MANUAL

DRIP COFFEE MACHINE

MANUEL D'UTILISATION

CAFETIÈRE FILTRE

MANUAL DE USO

CAFETERA DE FILTRO

EN

FR

ES



Important information for the user Informations importantes pour l'utilisateur Información importante para el usuario



Instructions / Instructions / Instrucciones



Description / Description / Descripción



Use / Usage / Uso



Cleaning and maintenance / Nettoyage et entretien / Limpieza y mantenimiento



Safety instructions / Directives de sécurité / Instrucciones de seguridad



Information / Informations / Información



Advice / Conseil / Recomendaciones



Scan the QR code for quick access to the My Smeg Assistant portal
Scannez le code QR pour un accès rapide au portail My SMEG Assistant
Escanee el código QR para acceder rápidamente al portal My Smeg Assistant

Dear Customer, Thank you for purchasing one of our appliances. Our products are unique because they combine iconic style with innovative technical solutions. They match perfectly with other products in our range and work equally well as a standalone design objects in your kitchen. We hope you enjoy using your new appliance! Best regards.

Cher client, merci beaucoup pour votre achat. Nos produits sont uniques car ils combinent une forte recherche esthétique avec une conception technique innovante. Ils sont coordonnés avec d'autres produits de la gamme et peuvent constituer des éléments d'ameublement et de design. En espérant que vous pourrez apprécier pleinement votre nouvel appareil électroménager, nous vous adressons nos meilleures salutations.

Estimado cliente, gracias por comprar uno de nuestros aparatos. Nuestros productos son únicos porque combinan un estilo icónico con soluciones técnicas innovadoras. Combinan perfectamente con otros productos de nuestra gama y funcionan de igual manera como objetos de diseño independientes en su cocina. ¡Esperemos que disfrute de su nuevo aparato! Reciba un cordial saludo.

SMEG S.p.A.

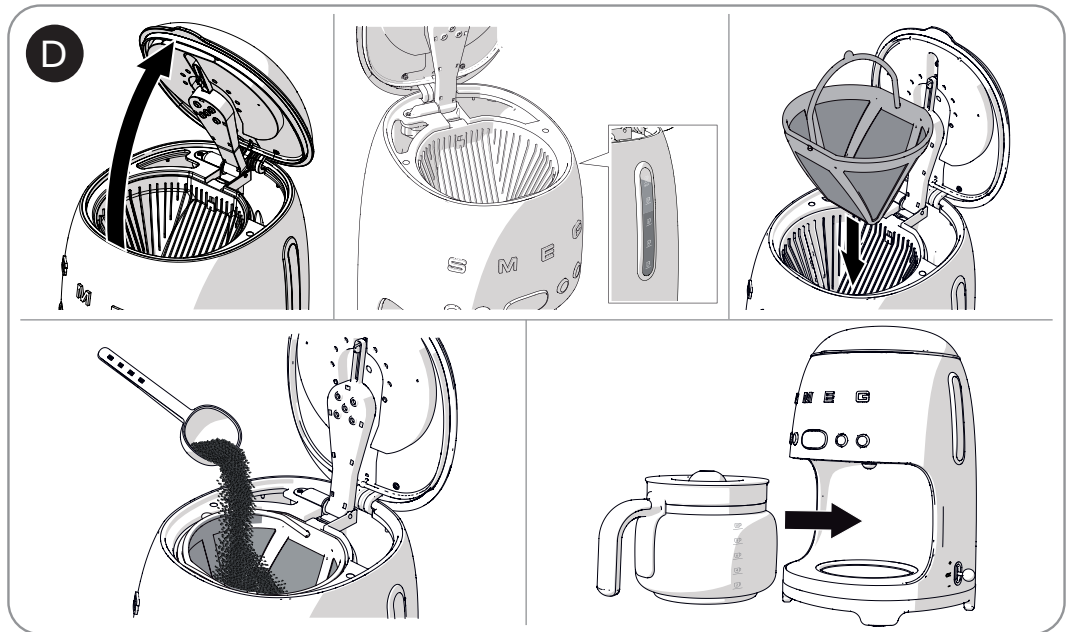
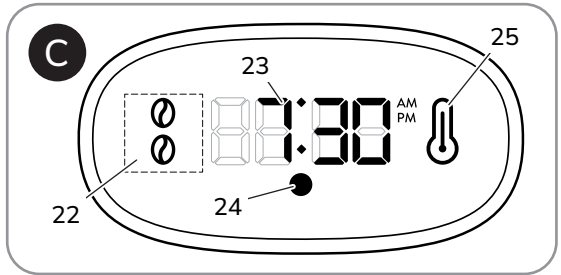
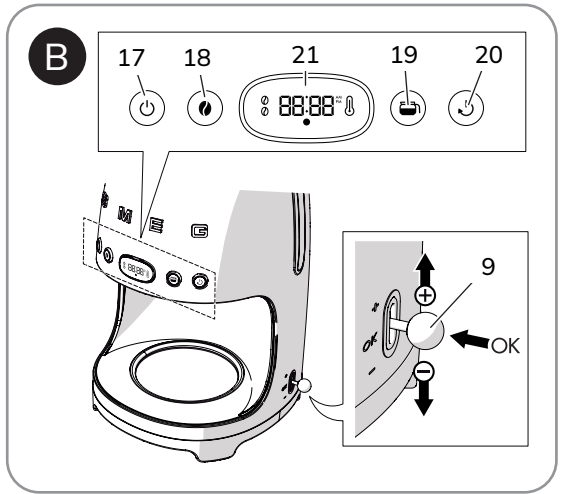
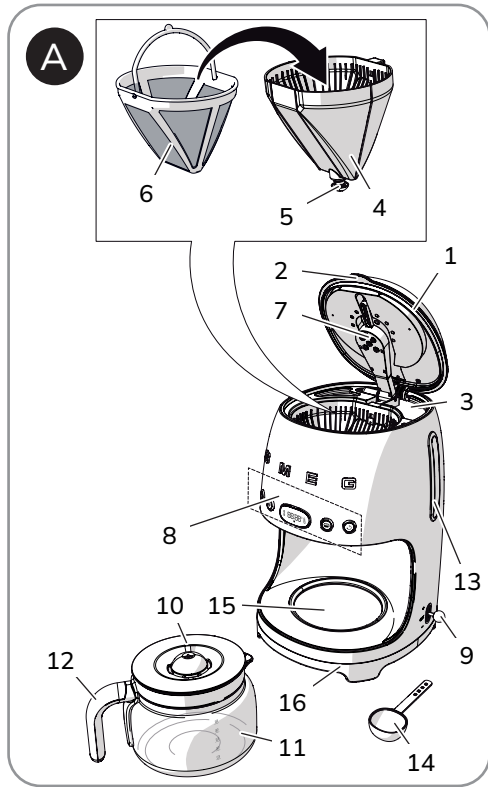

IMPORTANT SAFEGUARDS



WARNING: If the instructions contained in this manual are not followed carefully, a fire or explosion may result causing property damage, personal injury or death.



READ AND SAVE THESE INSTRUCTIONS

Your safety and the safety of others are very important. We have provided many important safety messages throughout this manual and on the appliance. Read all the instructions before using the appliance and always obey all safety messages.



RECOGNIZE SAFETY INFORMATION

This is a safety alert symbol. This symbol alerts you to potential hazards that can result in severe personal injury or death.

UNDERSTAND SIGNAL WORDS

A signal word - DANGER, WARNING, or CAUTION - is used with the safety alert symbol. DANGER denotes the most serious hazards. It means you could be killed or seriously injured if you do not follow the instructions immediately. WARNING means you could be killed or seriously injured if you do not follow the instructions. CAUTION indicates a potentially hazardous situation, which, if not avoided, could result in minor to moderate injury.

WARNING



- This appliance is intended for household use only.
- Use this appliance only for its intended purpose. The manufacturer cannot be held liable for damage caused by the improper use of this appliance.
- This appliance complies with current safety regulations. Improper use can result in personal injury and material damage.
- Read all the instructions before installing or using the appliance for the first time.
- Keep these operating instructions in a safe place and pass them on to any future user.



IMPORTANT SAFEGUARDS

WARNING



To reduce the risk of fire or electric shock, do not remove the cover (or back).

No user-serviceable parts inside!

Repair should be done by authorized service personnel only.

The safety messages will inform you of potential hazards, on how to avoid the risk of injury and what can occur if the instructions are not followed.

IMPORTANT: Observe all codes and ordinances in force.

WARNING: For your safety, the instructions contained in this manual must be followed to minimize the risk of fire or explosion and to prevent property damage, personal injury or death.

Do not store or use gasoline or other flammable vapors, liquids or materials near this or any other appliance.



NOTE: This appliance is NOT designed for installation in manufactured (mobile) homes or in recreational vehicles (RVs).

DO NOT install this appliance outdoors.

WARNING



To reduce the risk of fire, electrical shock, personal injury, or damage when using the appliance, follow basic safety precautions, including the following:

IMPORTANT SAFEGUARDS



1 Safety

1.1 Essential safety information

Follow all the safety instructions in order to use the appliance safely:

- Read this user manual carefully before using the appliance.
- Do not immerse the appliance in water.
- Failure to observe these warnings can lead to fire, electrocution or even death.
- If the plug or power cord becomes damaged, have them replaced only by an authorized service center in order to avoid risks.
- Switch off the appliance immediately after use.
- Always disconnect the appliance from the electrical outlet before assembling and disassembling components and before cleaning.
- Unplug the coffee machine before cleaning it and if you notice any fault.
- Let the appliance cool down before cleaning.
- Do not use the appliance if there is no water in the tank. Use cold, preferably filtered, water. Do not use other liquids.
- Make sure that the lid is firmly closed.
- Danger of burns! Do not open the lid while coffee is being brewed.
- Danger of burns! Do not touch hot surfaces with your hands: use the handles and buttons.
- Danger of burns! The keep warm plate under the jug remains hot for a few minutes after the coffee has been brewed. Do not touch it.
- To protect against electric shock, do not place cord, plugs, or appliance in water or other liquid.
- Close supervision is necessary when any appliance is used by or near children.
- Do not operate any appliance with a damaged cord or plug or after the appliance malfunctions, or has been damaged in any manner. Return appliance to an authorized service facility for examination, repair or adjustment.
- Do not let cord hang over edge of table or counter, or touch hot surfaces.
- To disconnect, turn any control to the off position, then remove plug from wall outlet.
- Do not use appliance for other than intended use.
- The container is designed for use with this appliance. It must never be used on a range top.
- Do not use a cracked container or a container having a loose or weakened handle.
- Do not clean container with cleansers, steel wool pads, or other abrasive material.
- Unplug from outlet when either the appliance or display clock is not in use, and before cleaning. Allow to cool before putting on or taking off parts, and before cleaning the appliance.
- Scalding may occur if the lid is removed during the brewing cycles.



IMPORTANT SAFEGUARDS

- The use of accessory attachments not recommended by the appliance manufacturer may result in fire, electric shock or injury to persons.
- Do not use outdoors
- Do not let cord hang over edge of table or counter, or touch hot surfaces.
- Do not place on or near a hot gas or electric burner, or in a heated oven.
- To disconnect, turn any control to “off,” then remove plug from wall outlet.
- Do not set a hot container on a wet or cold surface.
- Do not use the appliance or parts of it with parts or accessories made by other manufacturers.
- Only use original spare parts. The use of spare parts not approved by the manufacturer could lead to fires, electric shocks or personal injury.
- Only place the appliance on level and dry surfaces.
- Avoid getting the appliance wet and do not spray liquids onto it. In the event of contact with liquids, immediately switch off the power at the outlet or main breaker and dry the appliance thoroughly: Electric shock hazard!
- Do not position the appliance near sinks or taps.
- Do not use harsh detergents or sharp objects to clean the drip coffee machine.
- Do not make any modifications to the appliance.
- Never try to put out a fire or flames with water: turn off the appliance, remove the plug from the power outlet and smother the flames with a fire blanket or other appropriate cover.
- Prevent the power cord from coming into contact with sharp edges.
- Never position the appliance above, near electric or gas cooktop burners when they are hot or in use, inside an oven or near other heat sources.
- Before pouring the coffee, make sure that the lid has been inserted firmly into the top of the jug.
- Do not place the jug on a cooktop, in an oven or in a microwave oven.
- Do not place the hot jug on cold or wet surfaces.
- Do not use the jug if it is damaged or if the handle is loose.
- Fill the water tank before inserting the plug to the electrical outlet.
- Do not install the appliance in environments in which the temperature is 0°C or less.
- This appliance is not intended for use by persons (including children) with reduced physical, sensory, or mental capabilities, or lack of experience and knowledge, unless they are closely supervised and instructed concerning use of the appliance by a person responsible for their safety. Children should be supervised to ensure that they do not play with the appliance.
- This manual contains instructions for cleaning, maintenance and recommendations from the manufacturer to the customer.

IMPORTANT SAFEGUARDS



Any other intervention should be carried out by an authorized service center.

- Instructions for cleaning the appliance can be found in section “4 Cleaning and maintenance”.

1.2 Connecting the appliance

Make sure that the power supply voltage and the frequency correspond to those indicated on the data plate on the bottom of the appliance.

1.3 Electrical Cord:

- A short power-supply cord (or detachable power-supply cord) is provided to reduce risks resulting from becoming entangled in or tripping over a longer cord.
- Longer detachable power-supply cords or extension cords are available and may be used if care is exercised in their use.
- If a long detachable power-supply cord or extension cord is used:
 - 1) The marked electrical rating of the detachable power-supply cord or extension cord should be at least as great as the electrical rating of the appliance;
 - 2) If the appliance is of the grounded type, the extension cord should be a grounding-type 3-wire cord; and
 - 3) The longer cord should be arranged so that it will not drape over the counter top or table top where it can be pulled on by children or tripped over.

1.4 Intended use

- The appliance can be used to prepare drip coffee. Every other use is considered improper. Do not use the appliance for anything other than its intended use.
- Do not use the appliance outdoors.
- The appliance must not be used inside a piece of furniture.
- CAUTION: Do not use the appliance if the surface is cracked.



The California Safe Drinking Water and Toxic Enforcement Act requires the Governor of California to publish a list of substances known to the State of California to cause cancer, birth defects or other reproductive harm, and requires businesses to warn customers of potential exposure to such substances.



Warning

- This product contains a chemical known by the State of California to cause cancer, birth defects or other reproductive harm.
- This appliance can cause low-level exposure to some of the substances listed, including benzene, formaldehyde, carbon monoxide, toluene, and soot.



IMPORTANT SAFEGUARDS

1.5 Manufacturer liability

The manufacturer shall not be liable for injuries or property damage caused by:

- Use of the appliance other than that specified
- Failure to read the user manual
- Tampering with any part of the appliance
- Use of non-original spare parts
- Failure to comply with the safety instructions



Please keep these instructions carefully. If the appliance is passed on to others, they should also be given this instructions booklet.

These instructions can be downloaded from the Smeg website “www.smeg.com”.

1.6 Disposal



Devices marked with this symbol are subject to European Directive 2012/19/EU

- All waste electrical and electronic appliances must be disposed of separately from household waste and taken to authorized waste disposal facilities. Disposing of the used appliance correctly will help to safeguard the environment and human health. For further information regarding the disposal of used appliances, please contact your local authorities, the waste disposal department or the store where the appliance was purchased.

SAVE THESE INSTRUCTIONS



2 Appliance description (Fig. A)

- 1) Lid
- 2) Tab
- 3) Water tank (1.4 liters)
- 4) Filter holder
- 5) Anti-drip valve
- 6) Permanent filter
- 7) Boiler outlet
- 8) Control panel and display
- 9) Time / timer setting lever
- 10) Jug lid
- 11) Jug (10 cups)
- 12) Jug handle
- 13) Water tank level indicator (max. 1.4 liters)
- 14) Scoop
- 15) Keep Warm plate
- 16) Base and non-slip feet

2.1 Identification plate

The identification plate bears the technical data, serial number and brand name of the appliance.

Do not remove the identification plate for any reason.

2.2 Before first use

- Carefully unpack the appliance, remove all packaging materials and remove the label from the display.
- Thoroughly wash and dry the components of the drip coffee machine (see section "4 Cleaning and maintenance").



Before use, make sure that all components are intact and that there are no cracks

2.3 Description of controls (Fig. B)

ON/OFF button (17)

Dispense button. When the button is pressed, the machine starts brewing coffee according to the preset functions. You can stop brewing coffee at any time by pressing the button again.

Aroma button (18)

Pressing the button allows you to select between Delicate and Intense Aroma.

The intensity selection will be shown on the display: one bean for Delicate Aroma or two beans for Intense Aroma.



The aroma setting is maintained for subsequent brewing cycles.

4-Cup button (19)

This button allows you to brew a small amount of coffee, corresponding to approximately 4 cups.

To activate the 4-cup function, see section "4 cups function".

Autostart button (20)

This button allows the appliance to be programmed to switch on automatically to prepare drip coffee at a time selected by the user.

To set, activate and use this function, see the section "Autostart function".

Time / timer setting lever (9)

The lever at the side allows you to select and set the machine settings such as:

- setting the time
- selecting and setting the water hardness
- setting the sounds

For more details on the settings, see the section "Machine settings".



Description

2.4 Display Description (Fig. C)

The display (21) allows the user to view the functions set on the machine:

	Icon	Meaning
22		Delicate Aroma
		Intense Aroma
23		Time
24		Red: Descaling recommended
25		Keep Warm



The KEEP WARM  mode is activated automatically after the coffee has been brewed and keeps the warming plate on for 60 minutes. In this way, the coffee will remain hot for 60 minutes after it has been brewed.



3 Use (Fig. D)

- Make sure that the plug is properly inserted into the electrical outlet.



When you connect the machine to the power supply, you are prompted to set the time (see section “Machine settings”)

- Lift the lid (1) by pulling the tab upwards (2).
- Fill the tank (3) with fresh clean water, taking care not to exceed the maximum level shown on the level indicator (1.4 liters) (13). Exceeding the maximum level may cause water to leak and irreparably damage to the appliance.



To make it easier to fill the tank, make sure that the lid is completely open.



Caution

- Do not use the drip coffee machine if there is no water in the tank.
- Only put fresh clean water in the tank.
- Do not use liquids other than water.



The components intended to come into contact with food are made of materials that comply with the provisions of current legislation.

- Hold the lid of the water tank open and insert the permanent filter (6) into the filter holder (4).
- Add the amount of coffee required, according to the number of cups to be prepared, using the scoop (14) provided.





The permanent filter allows you to prepare filter coffee without using paper filters. However, if you prefer, a paper filter #4 can be used instead.

Place the paper filter in the filter holder and add the required amount of coffee.

One level scoop of ground coffee is approximately equivalent to one cup of filter coffee. However, the amount of ground coffee to be used may vary according to personal taste.

Use good quality medium ground coffee.

- Close the lid by lowering the tab (2).
- Place the jug (11) with the lid (10) on the keep warm plate (15). Make sure that the lid (10) fits perfectly into the anti-drip valve (5).
- Press the button (17)  to start brewing coffee. The LED on the button (17)  lights up and flashes quickly for the entire time the coffee is being brewed.



It is normal for steam to be produced while the coffee is being brewed.



Use



Caution

Do not open the lid of the water tank while the coffee is being brewed.

- You can stop brewing coffee at any time by pressing the button (17) .



Caution

- Do not open the lid of the drip coffee machine as soon as the brewing cycle has finished. Wait for at least 5 minutes after the coffee has been brewed before opening the lid.
- After 5 minutes, it is possible to remove and clean the filter and fill the tank again to brew more coffee.



If the button (17)  is not pressed, coffee will continue to be brewed according to the automatic settings and fill the jug completely (10 cups) or until there is no water remaining in the tank. The other buttons, even if pressed, have no effect and do not stop coffee from being brewed.





Caution





- The filter holder and the permanent filter may be hot after the coffee has been brewed. Be careful when removing them.
- The base of the jug may be very hot after the coffee has been brewed. Take care when removing it and make sure that you do not place the jug on a heat-sensitive surface.
- The Keep Warm plate remains warm after the coffee has been brewed: be careful not to touch it when removing the jug.

KEEP WARM mode

Once the coffee has been brewed, the KEEP WARM  mode is activated automatically and keeps the warming plate on for 60 minutes. In this way, the coffee will remain hot for 60 minutes after it has been brewed.

In the KEEP WARM  mode, the LED of button (17)  flashes slowly and the KEEP WARM  icon lights up on the display.

At the end of the KEEP WARM  mode, button (17)  turns off automatically.

The KEEP WARM  mode can be stopped manually at any time by pressing button (17) : the LED of button (17)  and the KEEP WARM  icon turn off.





The KEEP WARM  mode cannot be activated if brewing is stopped manually or if the 4 CUPS mode is active.



4 cups function

Brews a small amount of coffee, corresponding to approximately 4 cups:

- Press button (19)  to activate it, the LED turns on.
- Press button (19)  again to deactivate it.



Autostart function

The automatic start time has to be set before the automatic start function can be programmed.

Setting the Autostart time

- Make sure that the time displayed is correct. Otherwise, set the correct time as described in section "Machine settings".
- Press and hold the button for 3 seconds to set the time for the automatic start mode: the LED of the button and the time display (HH:MM) start to flash.
- Move the lever up (+) or down (-) to set the time.
- Confirm the time by moving the lever to the central position and press (OK): the set time will be saved automatically and will be used until it is modified.

Autostart function activation

- Press button (20) : the LED of button (20)  will light up and the hours and minutes of the set start time for brewing the coffee will flash for a few seconds on the display. Then the current time will be displayed.



You can also select the intensity (Aroma button) and the 4-cup function when using the Autostart function. Press the relative buttons to memorize the functions.

- The appliance remains in AUTOSTART mode until the preset time is reached. Coffee will be brewed automatically.
- Press button (20)  at any time to exit from this mode.

Machine settings

The appliance allows you to personalize some settings:

- clock settings
- time format
- water hardness
- activation / deactivation of the acoustic signals

Setting the clock

The time has to be set when you use the appliance for the first time:

- Plug the appliance into an electrical outlet.
- The symbols on the display flash.
- Set the time by moving the lever up (+) to increase the value or down (-) to decrease it. Move the lever to the central position and press (OK) to confirm.
- Set by following the same procedure.
- After confirming the minutes setting, the appliance activates the CLOCK mode.





Use



When the appliance is switched on for the first time, the default time will be shown in the 12 h time format, indicating AM/PM. To change the time format, see the "Time format settings menu" section.

Time format settings menu

The time format can be set to display the time in a 12 h or an AM/PM format.

- Access the settings menu by pressing and holding buttons (18)  and (19)  at the same time for 3 seconds. Select SE01 by moving the lever and pressing it to the "OK" position.
- Move the lever to select the required format (12 h or 24 h)
- Move the lever to the central position and press (OK) to confirm the setting. The format will flash for 2 seconds: the setting is saved.





The time format only needs to be set once and the setting is saved.

Modifying the time

- Make sure that the required format (12 h or 24 h) has been set as indicated in the previous section.
- Keep the lever (9) pressed in the central position for 3 seconds: the display starts to flash.
- Modify the hours and minutes as indicated in the "Setting the clock" section.

Water hardness setting menu



The water hardness can be set by selecting one of the 3 settings: HARD, MEDIUM and SOFT.

- Access the settings menu by pressing and holding buttons (18)  and (19)  at the same time for 3 seconds. Select SE02 by moving the lever: the display shows HA02 by default (medium hardness).
- Move the lever up (+) or down (-) to set the required level: HA01 (soft), HA02 (medium) and HA03 (hard).
- Move the lever to the central position and press (OK) to confirm the setting.

The selection flashes for 2 seconds: the setting is saved.

Sounds settings menu

The sounds can be enabled/disabled as follows:

- Access the settings menu by pressing and holding buttons (18)  and (19)  at the same time for 3 seconds. Select SE03 by moving the lever (9).
- Move the lever up or down until OFF appears on the display to disable the sounds or ON to enable them.
- Move the lever to the central position and press (OK) to confirm the setting. The selection flashes for 2 seconds: the setting is saved.



4 Cleaning and maintenance

4.1 Instructions



Improper use
Danger of electrocution

- Unplug the drip coffee machine before cleaning it.
- Do not immerse the drip coffee machine in water or other liquids.
- Allow the drip coffee machine cool down before cleaning it.



Improper use
Risk of damage to surfaces

- Do not use steam jets to clean the drip coffee machine.
- Do not use cleaning products containing chlorine, ammonia or bleach on parts with metal surface finishes (e.g. anodized, nickel- or chrome-plated).
- Do not use abrasive or corrosive detergents (e.g. powder products, stain removers and metallic scourers).
- Do not use rough or abrasive materials or sharp metal scrapers.

4.2 Cleaning the body of the machine

To keep the outer surface of the machine in good condition, it should be cleaned regularly after use. Let the appliance cool down first. Clean with a soft, damp cloth.

4.3 Cleaning the drip coffee machine components

The permanent filter and the filter holder can be washed by hand under running water to remove coffee residues or in a dishwasher.

The jug can be washed in hot soapy water using a soft brush after emptying out any coffee residues in order to prevent stains.

Always dry the components thoroughly after cleaning.



Improper use

Do not wash the jug in a dishwasher as it could become permanently damaged

4.4 Rinsing the internal circuits

Rinse the internal circuits after filling the tank:

- Place the jug (11) on the Keep Warm plate (15) **WITHOUT** putting ground coffee into the filter.
- Press button (17)
- Wait for the cycle to finish and empty the jug.
- The appliance is now ready for use.



Cleaning and care

4.5 Descaling



Caution

- Coffee can be prepared even if the DESCALING alarm is active.
- Carry out a descaling cycle when prompted to do so by the appliance.
- Scale deposits can prevent the appliance from working correctly, especially if the water is particularly hard.



Regularly descaling the appliance helps to preserve the aroma of the coffee and to keep the appliance in good working order.







Danger of personal injury and damage to the appliance

- The descaler contains acid which can irritate the skin and eyes.
- Follow the manufacturer's instructions and safety warnings on the pack to the letter; they will also tell you what to do in the event of contact with skin or eyes.
- Use descaling products recommended by Smeg to avoid damaging the drip coffee machine.

The appliance automatically indicates when descaling should be carried out according to the set water hardness (see section “Water hardness setting menu”). The DESCALING icon on the display starts to flash.

To start the descaling cycle:

- Pour water and descaler into the water tank up to the maximum level indicated and using the amount recommended by the descaler manufacturer.
- Press buttons (17)  and (20)  at the same time for 5 seconds to activate the DESCALING mode: the LEDs of buttons (17)  and (20)  flash and the DESCALING icon continues to flash until the cycle finishes.
- At the end of the cycle, the display reverts to CLOCK mode and the DESCALING icon disappears from the display.
- Carry out a rinse cycle (see section “4.4 Rinsing the internal circuits”).

What to do if...

Problem	Possible causes	Solution
Coffee does not come out	No water in tank.	Fill the tank.
	Scale build-up.	Perform a descaling cycle.
Coffee takes a long time to be dispensed	Scale build-up.	Perform a descaling cycle.
The coffee has an acidic taste	Possible stagnation of coffee in the circuits.	Rinse as described in section "4.5 Descaling".
	The filter is not positioned correctly.	Insert the filter correctly in the filter holder.
The drip coffee machine overflows	The jug is not positioned correctly on the base.	Make sure that the jug is positioned correctly under the boiler outlet.
	There is no lid on the jug.	Place the lid on the jug.
	Excessive amount of coffee.	Place up to a maximum of 5 level scoops of ground coffee into the permanent filter.
Only water comes out of the drip coffee machine	Coffee is too finely ground.	Use ground coffee for drip coffee machines.
	No ground coffee in the filter.	Put the required amount of ground coffee into the filter.



If the problem has not been resolved or in the case of other types of fault, contact your local technical support center.

The manufacturer reserves the right to make any changes deemed necessary for the improvement of its products without prior notice. The illustrations and descriptions contained in this manual are therefore not binding and are merely indicative.

Le fabricant se réserve la faculté d'apporter, sans préavis, toutes les modifications qu'il jugera utiles pour l'amélioration de ses produits. Les illustrations et les descriptions figurant dans ce manuel ne sont pas contraignantes et n'ont qu'une valeur indicative.

El fabricante se reserva el derecho de realizar cualquier cambio que considere necesario para mejorar sus productos sin previo aviso. Las ilustraciones y descripciones contenidas en este manual no son vinculantes y son meramente indicativas.