

SENCOR®

SFP 6060

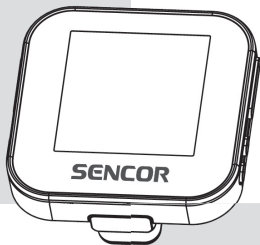

USER'S MANUAL

SPORT CLIP MP4 PLAYER

EN

1. Key features

- 1.5 inch TFT screen
- Support MP3, WMA, WAV formats audio
- Support AMV format video
- Support FM Radio
- Support MicroSD card
- Lyric display synchronously
- Multi EQ modes and repeat modes
- Support JPG format picture view
- Built-in microphone for long time recording
- Support txt E-book reading
- Built-in Games
- Multi-Languages OSD menu

2. Player Layout

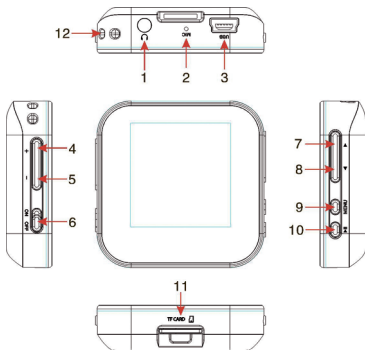

1. earphone port
2. microphone
3. USB port
4. volume +
5. volume -
6. power on/off
7. last/fast backward
8. next/fast forward
9. menu
10. play/pause/power on/off
11. MicroSD slot
12. neck strap

3. Operation instruction

- **Power On/Off**

In the status of power off push power button to on, then long press ►|| to turn on the player

In the status of power on, long press ►|| to turn off, then push power button to off.

- **Basic Operation**

In main menu interface, press ◀/▶ to select option, press **MENU** to enter. Long press **MENU** to get back to main menu interface. Short press **MENU** to confirm selection and short press ►|| to play.

3.1 Music

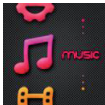

In Main interface, short press ◀/▶ to select **Music** menu, then short press **MENU** to enter music play interface.

Play/Pause: short press ▶|| to play or pause the music playing.

Last/next: short press ◀ or ▶ to get to last music or next music.

Fast backward/Fast forward: long press ◀ or ▶ to fast backwards or forwards the music.

Volume: press + or - to adjust volume up or down.

A-B repeat: in playback interface, firstly must pause playing music file, then short press **MENU** button to get to sub-menu, select "Replay mode", . short press **MENU** to enter and select "Replay", now in playback interface, short press ◀ and ▶ to set Start point A and End point B. Short press **MENU** to quit AB repeat.

Lyric show: To show the lyric, the lyric file (eg. Abcde.lrc) should be in same name as music file (eg. Abcde.mp3) and both files should be in the same folder. While playing a music file, long press **MENU** to show lyric, short press **MENU** to quit.

Music file list: in playback interface, firstly must pause playing music file, then short press **MENU** button to get to sub-menu, select "Local folder" to show folder/file list. Press ◀/▶ to select music file, press **MENU** button to confirm and press ▶|| to play.

Set EQ: in playback interface, firstly must play music file, then short press **MENU** button to get to sub-menu, select "Equalizer" and press **MENU** button to enter. There are "Natural, Rock, Pop, Classic, Soft, Jazz, DBB" for selection.

Set Play/Repeat mode: in playback interface, firstly must play music file, then short press **MENU** button to get to sub-menu, select "Repeat" and press **MENU** button to enter. There are "Normal, Repeat one, Folder, Repeat folder, Repeat all, Random, Intro" for selection.

3.2 Movie

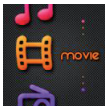

In Main interface, short press ◀/▶ to select **movie** menu, then short press **MENU** to enter movie playback interface.

Play/Pause: short press ▶|| to play or pause the video playing.

Last/next: short press ◀ or ▶ to get last or next video.

Fast backward/Fast forward: long press ◀ or ▶ to fast backwards or forwards the video.

Volume: press + or - to adjust volume up or down.

Video file list: Short press **MENU** to show "Local folder" and select, short press ◀/▶ to select movie files. Press **MENU** to select video file and press ▶|| button to play it.

*Remark: the player support video formats of .amv. Resolution should be 128x128. Please use video converting tool in gift CD to convert the video to which this player support (*reference to point 5).*

3.3 Radio



In Main interface, short press ◀/▶ to select **Radio** menu, then short press **MENU** to enter FM radio interface.

Manual Scan: Short press ◀ or ▶ to select frequency manually. Long press ◀ or ▶ player will auto scan and stop till it find channel.

Auto Scan: press **MENU** to show submenu, press ◀/▶ to select **Auto Search** then press **MENU** button. Then the player will scan channels and set the found channels to Preset one by one. After auto scan, it'll get to the first preset channel. Press ◀ or ▶ to get to preset channels one by one.

Save Channel: press **MENU** to show submenu, short press ◀/▶ to select **Save** then press **MENU** button.

Delete Channel: press **MENU** to show submenu, short press ◀/▶ to select **Delete** then press **MENU** button. Select **Delete All** will delete all saved channels.

Volume: press + or - to adjust volume up or down.

FM Record: press **MENU** to show submenu, short press ◀/▶ to select **Record** then press **MENU** button to enter, press ▶|| to start record or pause, long press **MENU** to save and quit FM Record.

Remark: Earphone should connect to player as an antenna. Otherwise the player can not receive channels.

3.4 Photo

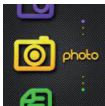

In Main interface, short press ◀/▶ to select **Photo** menu, then short press **MENU** button to enter picture list. Press ◀/▶ to select picture file, press ▶|| button to view the picture, press ▶|| again to quit viewing.

Last/next: short press ◀ or ▶ to display last or next picture.

Auto Browse: in picture list interface, short press **MENU** to show submenu, select "Playback set" and then select "Auto play" to set the auto browse seconds time, press **MENU** to confirm setting.

Photo file list: in picture list interface, press **MENU** button to show submenu, select "Local folder" to show folder/file list. Press ◀/▶ to select folder, press **MENU** button to enter and press ▶|| display it.

3.5 Record

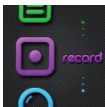

In Main interface, short press ◀/▶ to select **Record** menu, then short press **MENU** button to enter recording interface.

Record/Pause: short press ▶|| to record or pause.

Stop: long press **MENU** to save file and get to main interface, File of recorded voice are saved in folder of **VOICE**.

3.6 Voice

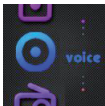

In Main interface, short press ◀/▶ to select **Voice** menu, then short press **MENU** button to enter recording file playback interface.

FM radio record file and Voice record file can be played under this menu.

Record file list: in playback interface, firstly must pause playing music file, then short press **MENU** button to get to sub-menu, select “Local folder” to show folder/file list. Press ◀/▶ to select music file, press **MENU** button to confirm and press ▶|| to play.

3.7 Text

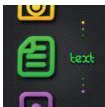

In Main interface, short press ◀/▶ to select **Text** menu, then short press **MENU** button to enter E-book file list. Press ◀/▶ to select E-book file, press ▶|| button to view the text.

Manual Browse: short press ◀/▶ to browse up or down page by page.

Auto Browse: in Ebook file list interface, short press **MENU** to show submenu, select “Playback set” and short press **MENU** to enter, select “Auto play” to set the auto browse seconds time, then press **MENU** to confirm setting.

Text file list: in Ebook file list interface, short press **MENU** button to get to sub-menu, select “Local folder” to show folder/file list. Press ◀/▶ to select Ebook file, press **MENU** button to confirm and press ▶|| to read.

3.8 Game

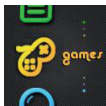

In Main interface, short press ◀/▶ to select **Game** menu, then short press **MENU** button to enter game list. Press ◀/▶ to select game, press **MENU** button to enter the game options. During game playing, short press to quit ▶|| game and enter game options.

3.9 Search

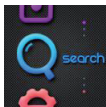

In Main interface, short press ◀/▶ to select **Search** menu, then short press **MENU** button to list folders/files in memory. **Play/Open file:** press ◀/▶ to select file/folder, press **MENU** to play or open it. If the file is not supported by this player, it can not play or open.

Delete file: in each function sub-menu, there is option of “Delete file” and “Delete all”. Select file want to delete, then press **MENU** there will be a warning, select Yes to delete file, or select No to cancel deleting.

3.9 Setup



In Main interface, short press ◀/▶ to select **Setup** menu, then short press **MENU** button to enter setting options. (In submenu, press ▶|| to get to upper menu.)

3.10.1 System time:

Set the system time and date, short press +/- to select time or date, short press ◀/▶ to adjust number, short press **MENU** to confirm setting.

3.10.2 Restore Default:

Short press **MENU** to select “OK” to restore default setting.

3.10.3 LCD set:

Set the LCD turn off time.

Short press **MENU** to enter and select “Dark Mode”, then adjust the number by pressing ◀/▶ to set, press **MENU** to confirm setting.

“0” mean not auto turn off LCD.

3.10.4 Language:

Set the system language.

3.10.5 Power off:

Set the Auto Power off time and Sleep time.

Short press **MENU** to enter and select “Off time” or “Sleep time”, then adjust the number by pressing ◀/▶ to set, press **MENU** to confirm setting.

“0” mean not auto power off or not sleep.

3.10.6 Online mode:

Set player driver status among "Multiply driver", "Normal only", "Encrypted only", "Card only".

3.10.7 Memory info:

View the flash memory status.

3.10.8 Format Device:

Format the player flash memory and it become empty. (**Please do remember to save files before format player, to avoid files loss*)

3.10.9 Firmware version:

View the player firmware version.

3.10.10 Firmware upgrade:

Upgrade the player firmware, do connect the player to computer via USB cable, while upgrade the player. (**Reference to point 4*)

3.10.11 Key tone:

Set key tone volume.

3.10.12 Exit:

Exit settings.

4. Firmware upgrade

If the player doesn't work or works sub normally, find the firmware upgrade tool and firmware in gift CD to upgrade the player. Processes as bellow:

Note before updating: a. Don't upgrade firmware if playing properly. b. Backup files to other storage before upgrade.

A. Use a USB cable to connect with computer, the player show interface:

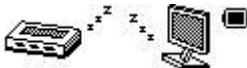

B. Installation upgrade tooling is completed on the computer, then go to PC Start→ Program →media player utilities. Open the "media player upgrade tool", in computer show below interface.

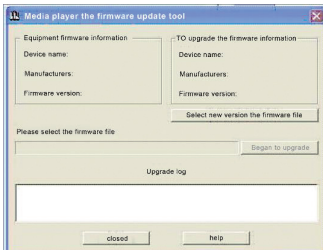

- C. Click “select new version the firmware file”, to load the firmware file from computer. Click “start” button, starts to upgrade software.

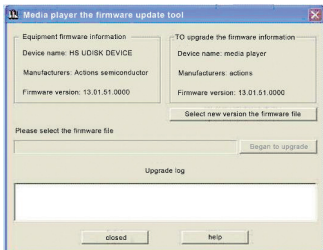

- D. During the firmware updating process, don't interrupt the player with PC connection. When upgrading is complete, the software will have a message box that “the firmware update successful, program will automatically exit!”. Then player would automatically shut off and restart, the whole upgrade work is completed.

5. Video Convert

The player support video of AMV format in resolution of 128x128. Please use the software in gift CD to convert the video. The AMV&AVI Converter supports multi kind of video formats (AVI, RM, RMVB, MPG, MPG4, ASF, DAT, WMV, etc) convert to AVI format.

5.1 AVI Converter Tool Setup

Click folder EndUserTools to find and click software setup.exe in gift CD; follow the steps to install to PC.

5.2 Convert Video to AVI format

From PC>Program to run AMV&AVI Converter as below picture and steps for converting

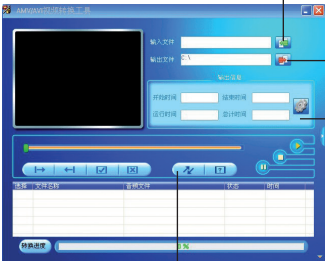

The screenshot shows the AMV&AVI Converter software interface. It features a central video preview window, input and output file fields, a 'Video Size' section with resolution and quality settings, a playback control bar, and a progress bar at the bottom. Four numbered callouts point to specific controls: 1) 'Click Add file' points to the file selection icon; 2) 'Select saving Location' points to the folder selection icon; 3) 'Set resolution to 128x128, set quality.' points to the resolution and quality dropdown menus; 4) 'Click to start converting, wait until success.' points to the main conversion button.

- 1) Click Add file
- 2) Select saving Location
- 3) Set resolution to 128x128, set quality.
- 4) Click to start converting, wait until success.

After converting, copy the converted video file to the player, then enjoy it through player.

6. Specification

Items: SFP 6060

Dimensions 43.5 x 43.5 x 12.5 mm (W x H x D)

Colour TFT display: 1.5-inch TFT display; 65,000 true colours, resolution (128 x 128)

Language support: Multi-language system (EN, CZ, SK, HU, PL)

Data transfer speed: High-speed USB 2.0

Reading: 4 Mb/s, Writing: 1 Mb/s

Supported file formats

Audio:

MP3: 8 kb/s – 320 kb/s

WMA: 32 kb/s – 320 kb/s

WAV: 64 kb/s/256 kb/s

Images: JPEG

Supported video formats: AMV (All formats should be converted to the .AMV format using the provided software)

Text: For letters with diacritic symbols use UNICODE coding

Noise to signal ratio: (S/N) 85 dB

Frequency range: 20 Hz - 20 kHz

Max. output power: 10 mW + 10 mW

Flash memory: 4 GB

Slot for a micro SDHC card (max 16GB)

Power supply: Lithium-polymer battery 3.7 V

Battery operation time: Playback of video: 4 to 5 hours

Playback of MP3: 12 to 13 hours (power-saving mode)

Operating temperature: 5°C to 40°C

Supported operating system: WINDOWS 2000/XP, Mac OS 10.4.6

Weight: Approximately 23 g

Accessories: User's manual, headphones, USB cable, installation CD

INSTRUCTIONS AND INFORMATION REGARDING THE DISPOSAL OF USED PACKAGING MATERIALS

Dispose of packaging material at a public waste disposal site.

DISPOSAL OF USED ELECTRICAL AND ELECTRONIC APPLIANCES



The meaning of the symbol on the product, its accessory or packaging indicates that this product shall not be treated as household waste. Please, dispose of this product at your applicable collection point for the recycling of electrical & electronic equipment waste. Alternatively in some states of the European Union or other European states you may return your products to your local retailer when buying an equivalent new product. The correct disposal of this product will help save valuable natural resources and help in preventing the potential negative impact on the environment and human health, which could be caused as a result of improper liquidation of waste. Please ask your local authorities or the nearest waste collection centre for further details. The improper disposal of this type of waste may fall subject to national regulations for fines.

For business entities in the European Union

If you wish to dispose of an electrical or electronic device, request the necessary information from your seller or supplier.

Disposal in other countries outside the European Union

If you wish to dispose of this product, request the necessary information about the correct disposal method from local government departments or from your seller.



This product meets all the basic EU regulation requirements that relate to it.

Changes to the text, design and technical specifications may occur without prior notice and we reserve the right to make these changes.