

INTRODUCTION

Thank you for choosing a De'Longhi product. Please take few moments to read the instructions to avoid risks or damage to the appliance.

Symbols used in these instructions

Important warnings are identified by the symbols below.

It is important to respect the warnings.

Failure to respect the warnings could lead to electric shock, serious injury, burns, fire or damage to the appliance.



Danger!

Failure to observe the warning may result in life threatening injury by electric shock.



Important!

Failure to observe the warning could result in injury or damage to the appliance.



Danger of burns!!

Failure to observe the warning could result in burns or scalds.



Please note:

This symbol indicates recommendations and important information for the user.

IMPORTANT SAFEGUARDS

When using any electrical appliance, some basic safety precautions should always be observed to reduce the risk of fire, electric shock, and/or injury to persons. Read all instructions carefully before using the appliance. Specifically:



Danger!

- Do not operate the appliance with a damaged cord or plug, after faulty operation, or when it has been dropped or damaged in any way. Contact the nearest authorized service facility for examination, electrical or mechanical adjustment, or repair.
- This heater is not intended for use in bathrooms, laundry areas, or similar indoor locations. Never position the appliance where it may fall into a bathtub or come in contact with water.
- Never use this heating appliance in the immediate vicinity of a bathtub, shower, or swimming pool.
- Do not insert or allow foreign objects to get into the air intake or air outlet grille, as this may cause electric shock or fire, or damage the appliance.
- **CAUTION: To prevent electric shock, make sure the wide prong of the plug is inserted in the wide slot of the outlet.**
- **Important!**
 - The appliance is not intended for use by persons (including children) with reduced physical, sensory or mental capabilities, or lack of experience and knowledge, unless they have been given supervision or instruction concerning use of the appliance by a person responsible for their safety. Children should be supervised to ensure that they do not play with the appliance.
 - Always disconnect the plug from the power outlet when the appliance is not in use.
 - Do not use the appliance outdoors.
 - Do not run the power cord under carpeting. Do not cover cord with throw rugs, runners, or the like. Keep the cord away from any passageways where it could be tripped over.
 - To prevent a possible fire, do not block air intake or air outlet grille in any way. Do not use the appliance on soft surfaces, such as beds, where the openings may become blocked.
 - Use this appliance only as described in this manual. Any other use not indicated by the manufacturer may cause fire, electric shock, or injury to persons.
 - To prevent current overload and blown fuses, make sure that no other appliance is plugged into the same outlet or into another outlet wired into the same circuit.
 - If the supply cord is damaged, to reduce the risk of malfunction it must be replaced by the manufacturer, its service agent, or a licensed and qualified professional.

- Do not use this appliance with an extension cord or outlet strip. Connect the appliance directly to a suitable outlet.
- Make sure that the plug is fully inserted into the outlet. Wall outlets may deteriorate with time, so check the plug periodically for signs of overheating or deformation. If the outlet has deteriorated, stop using it and have it repaired.
- Do not place the heater near a bed because objects such as pillows or blankets can fall off the bed and be ignited by the heater.
- Use the appliance always and only in the vertical position.
- Do not use this appliance in a room smaller than 43 square feet (4 m²).
- Do not use the appliance to dry laundry, and do not obstruct the air intake and outlet grilles (danger of overheating).
- Do not operate the appliance in contact with walls, furniture, curtains, etc.



Please note:

- To completely turn off the appliance, push the ON/OFF button (A), and then unplug the heater.
- Check that neither the appliance nor the power cord have been damaged during shipping.
- Make sure that no styrofoam or other packing materials remain in the appliance.
- The first time the appliance is used, run it at the maximum power for at least two hours. During this time, ventilate the room thoroughly to eliminate the “new” smell released by the appliance. It is completely normal for the appliance to emit “creaking” sounds the first time it is run.
- Do not open the appliance. No user-serviceable parts inside.
- Before storing the appliance, check it is completely off and the cable is unplugged. At this point wrap the cord around the base. Do not store in a dusty room. The room temperature should be between 32-86°F (0-30°C). Do not load anything above it.
- Heaters draw more current than small appliances, overheating of the outlet may occur even if it has not occurred with the use of other appliances.



Danger of burns!!

- This appliance gets very hot when in use. To prevent burns, do not touch hot surfaces with bare skin. Use the handle when moving the appliance. Keep all flammable materials, such as furniture, pillows, bedding, paper, clothing, and curtains at least 3 feet (90 cm) from the front and top of the appliance also avoid contact with the sides and back.
- Do not wrap the cord around the appliance immediately after use.
- Do not cover the appliance while it is functioning in order to avoid overheating and the risk of fire.
- The internal parts of the appliance can become very hot or produce sparks during operation. Do not use the appliance in areas where gasoline, paints, or other flammable liquids are used or stored.
- It is normal for heater’s plug and cord to feel warm to the touch. However, an excessively hot or deformed plug or cord is not normal and may be the result of a defective electrical outlet. Defective outlets must be replaced before using the heater. Plugging the heater into a worn outlet may result in overheating of the power cord or may cause the risk of fire.

SAVE THESE INSTRUCTIONS

THIS PRODUCT IS FOR HOUSEHOLD USE ONLY

DESCRIPTION

(see fig. 1)

- A** ON/OFF button
- B** +/- adjustment buttons
- C** MODE button (selects the operating mode)
- D** "ECO plus" button
- E** Timer button
- F** Swivel button
- G** Remote control receiver
- H** Indicator light
- I** Air intake grille
- J** Filter

USE

Installation

- The appliance can be used on any horizontal surface. Do not overload the electrical circuit. Avoid using the same outlet for other appliances.

Electrical connection

- Before plugging the appliance into the outlet, check that the outlet power corresponds to the value indicated on the rating plate and that the outlet power is adequate for the load.
- THIS APPLIANCE COMPLIES WITH DIRECTIVE 2004/108/EEC ON RADIO INTERFERENCE SUPPRESSION.

Mounting the base

- Fit the two parts of the base together, matching the guide pins on the front with the recesses on the back and snapping the two clips into place (fig. A and fig. B).
- Turn the appliance upside down and position the assembled base on the appliance in order to couple the two openings with the two tabs on the appliance, tilting it as shown in figure C, consequently turn the base down till the two frontal teeth snaps into position (figure D).
- Assembly time: approx. 5 minutes.
- Optional
 - Fasten the tower to the base using the screw provided to achieve extra stability.
 - Tools needed and estimated time:
 - 1 Phillips head screwdriver type PH 2 x 100
 - 1 screws (included)
 - Assembly time: approx. 2 minutes.

Operation and use

1. Plug into the outlet.
2. The appliance emits a beep. The indicator light (**H**) comes on and remains lit while the appliance is powered.
3. Press the ON/OFF button (**A**) to turn the appliance on. The appliance comes on with the setting used during the previous period of operation.

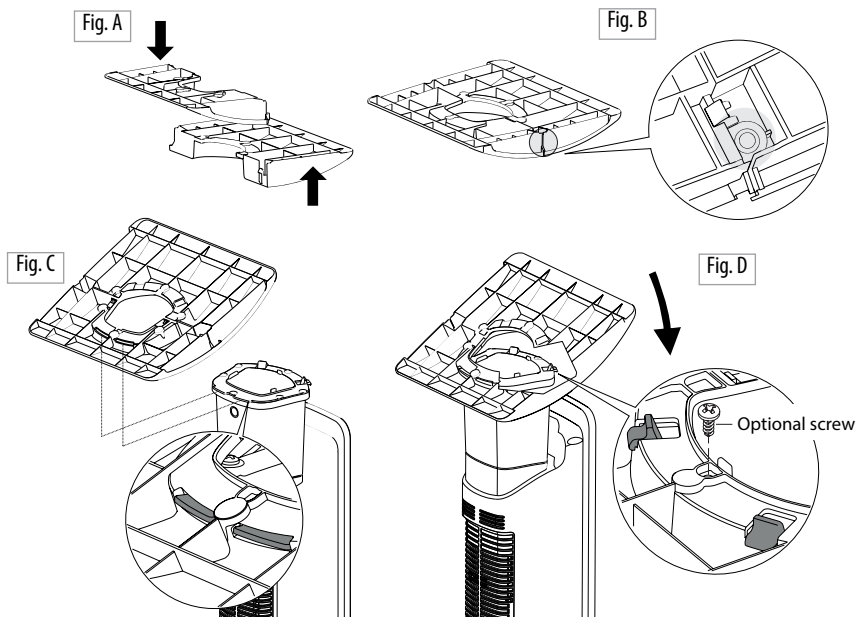

4. Press the MODE button (C) to select one of the following operating modes:

Fan ✨

Freeze prevention ✨

Heating 1 ✨

Heating 2 ✨

Heating 3 ✨

4.1 Fan ✨

In this mode, only the fan operates and the appliance does not heat the room.

4.2 Freeze prevention ✨

In this mode, the appliance keeps the room at a temperature of 45°F (7°C) to avoid freezing.

4.3 Heating 1, 2 and Heating 3 ✨

In this mode, the desired temperature can be selected by pressing the adjustment buttons + and - (B):

- Heating 1 ✨

The appliance operates at low power, reducing noise levels and energy consumption to a minimum.

- Heating 2 ✨

The appliance operates at medium power.

- Heating 3 ✨

The appliance operates at high power to heat the room rapidly.

i Please note: Room temperature can be displayed in either °F or °C. To change the unit of measurement for the temperature, press the + button for approx. 10 seconds, then release.

5. "ECO plus" function

The "ECO plus" function is available in Heating 1, 2 and 3 modes only. To activate the function, press the "ECO plus" button (D). When this function is active the appliance automatically sets the most appropriate power level to guarantee optimum comfort while reducing energy consumption. While the "ECO plus" function is active, the appliance may switch automatically to a lower heating power than the one displayed. This may happen a number of times in an hour.

6. Swivel button

To distribute the air flow over a wider surface, press the swivel button (F) . The appliance swivels to the right and left.

To stop the appliance in the desired position, simply press the swivel button (F) again.



7. Turn the appliance off

To turn the appliance off, press the ON/OFF button (A).



The display may show a countdown for about 6 seconds.

Digital 24 h timer (selection from 0.5 hrs to 24 hrs)

This function can be activated from any operating mode.

Auto-start: with the appliance in ON/OFF, press the timer button  (E). The  symbol is displayed together with the time remaining before the appliance comes on.

To adjust the timer, use the adjustment buttons + and - (B), then wait a few seconds for the setting to be stored. The stand-by light (H) is displayed together with the  symbol, indicating that the timer has been set. When the programmed time is reached, the appliance comes on with the settings used during the previous period of operation.

Auto-off: Auto-off: with the appliance on, press the timer button  (E). The  symbol is displayed together with the time remaining before the appliance goes off. To set the timer, use the adjustment buttons + and - (B), then wait a few seconds for the setting to be stored.

The current settings are displayed again, together with the  symbol indicating that the timer has been set. When the programmed time is reached, the appliance goes off automatically. To go back to operation without the timer, press the timer button (E) twice.

The timer symbol  disappears from the display.

Using the remote control

The functions on the remote control are the same as those on the appliance control panel. For a description of the functions, see the "Operation and use" section on the previous page.

Installing or replacing the batteries

The remote control is powered by one CR2032 3V lithium battery, already included inside. To operate the remote control, pull and remove the plastic strip under the battery cover. To replace the batteries, remove the battery cover by sliding it as shown in the figure. When replacing the batteries, make sure you respect the polarity (see figure 2).

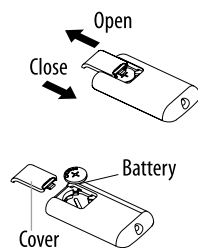

Fig. 2

Replace the cover as shown in the figure. Old batteries are harmful to the environment and must be removed and disposed of in compliance with current legislation. Non-rechargeable batteries are not to be recharged.

WARNING: DO NOT DISPOSE OF BATTERIES IN FIRE. BATTERIES MAY EXPLODE OR LEAK.

MAINTENANCE

- Always unplug from the outlet before cleaning.
- During the season when the appliance is in use, clean the air intake and outlet grilles regularly using a vacuum cleaner.
- To clean the filter, remove the rear grille by pulling it outwards (fig. 1). Remove the dust filter that retains impurities in the air drawn in from the room, blow on it lightly then put it back in the appliance.
- Never use abrasive powders or solvents to clean the appliance.

Safety functions

- **Safety device:** the appliance is fitted with a safety device that switches it off in the event of accidental overheating (e.g. obstruction of air intake and outlet grilles, motor turning slowly or not at all). To reset, unplug the appliance from the outlet for a few minutes, remove the cause of overheating, then plug in again.
- **Tip-over safety device:** a tip-over safety device turns the appliance off if it falls over or is positioned inappropriately in such a way as to jeopardize safety. The appliance emits a beep and a dot flashes on the display. The appliance resumes operation a few seconds after being placed in an upright position again.

TECHNICAL CHARACTERISTICS

Power supply	See rating plate
Absorbed power	"

NOTE: This equipment has been tested and found to comply with the limits for a Class B digital device, pursuant to Part 15 of the FCC Rules. These limits are designed to provide reasonable protection against harmful interference in a residential installation. This equipment generates, uses and can radiate radio frequency energy and, if not installed and used in accordance with the instructions, may cause harmful interference to radio communications. However, there is no guarantee that interference will not occur in a particular installation. If this equipment does cause harmful interference to radio or television reception, which can be determined by turning the equipment off and on, the user is encouraged to try to correct the interference by one or more of the following measures:

- Reorient or relocate the receiving antenna.
 - Increase the separation between the equipment and receiver.
 - Connect the equipment into an outlet on a circuit different from that to which the receiver is connected.
 - Consult the dealer or an experienced radio/TV technician for help.
- Modifications not approved by the party responsible for compliance could void user's authority to operate the equipment.

CAN ICES-3 (B) / NMB-3 (B)

TROUBLESHOOTING

PROBLEM	CAUSE	SOLUTION
PF display	Temperature sensor is not working properly	The product needs to be serviced, contact our toll free number for assistance
Product doesn't turn on	Check that the plug is connected to the outlet Auto-start is on Room temperature reaches the set temperature	Plug in Wait till time elapsed or press the button (E) twice to cancel the auto-start and push the button (A) Use the "+" button to increase the set temperature
A green dot is flashing and unit is off	The tip-over switch has been activated	Make sure the appliance is standing upright on a flat surface, if the problem persists contact our toll free number to assist you

LIMITED WARRANTY

This warranty applies to all products with De'Longhi or Kenwood brand names.

What does the warranty cover?

We warrant each appliance to be free from defects in material and workmanship. Our obligation under this warranty is limited to repair at our factory or authorized service center of any defective parts or part thereof, other than parts damaged in transit. In the event of a products replacement or return, the unit must be returned transportation prepaid. The repaired or replacement model will be returned at the company expense.

This warranty shall apply only if the appliance is used in accordance with the factory directions, which accompany it, and on an Alternating current (AC) circuit.

How long does the coverage last?

This warranty runs for one year (1) from the purchase date found on your receipt and applies only to the original purchaser for use.

What is not covered by the warranty?

The warranty does not cover defects or damage of the appliance, which result from repairs or alterations to the appliance outside our factory or authorized service centers, nor shall it apply to any appliance, which has been subject to abuse, misuse, negligence or accidents. Also, consequential and incidental damage resulting from the use of this product or arising out of any breach of contract or breach of this warranty are not recoverable under this warranty. Some states do not allow the exclusion or limitation of incidental or consequential damage, so the above limitation may not apply to you.

How do you get service?

If repairs become necessary, see contact information below:

U.S. Residents: Please contact our toll free hotline at 1-800-322-3848 or log onto our website at www.delonghi.com

Residents of Canada: Please contact our toll free hotline at 1-888-335-6644 or log onto our website at www.delonghi.com

Residents of Mexico: Please contact our toll free number 01-800-711-8805 for assistance or log onto our website at www.delonghi.com

The above warranty is in lieu of all other express warranties and representations. All implied warranties are limited to the applicable warranty period set forth above. This limitation does not apply if you enter into an extended warranty with De'Longhi. Some states/countries do not allow limitations on how long an implied warranty lasts, so the above exclusions may not apply to you. De'Longhi does not authorize any other person or company to assume for it any liability in connection with the sale or use of its appliance.

How does country law apply?

This warranty gives you specific legal rights, and you may also have other rights, which vary from state to state/country to country.