



# Synology Router RT2600ac

## Hardware Installation Guide

# Table of Contents

## Chapter 1: Meet Your Synology Router

Package Contents.....	3
RT2600ac at a Glance.....	4
Safety Instructions.....	5

## Chapter 2: Set up Your Synology Router

Install Antennas.....	6
Position Your RT2600ac.....	7
Connect to Your RT2600ac.....	7
Set up Synology Router Manager (SRM).....	9

## Appendix A: Specifications

## Appendix B: LED Indicator Table







# Meet Your Synology Router

Thank you for purchasing this Synology product! Before setting up your new RT2600ac, please check the package contents to verify that you have received all of the items below. Also, make sure to read the safety instructions carefully to avoid harming yourself or damaging your RT2600ac.

**Note:** All images below are for illustrative purposes only, and may differ from the actual product.

## Package Contents

Main unit x 1	AC power adapter x 1
	
	RJ-45 LAN cable x 1
	
	Antenna x 4
	



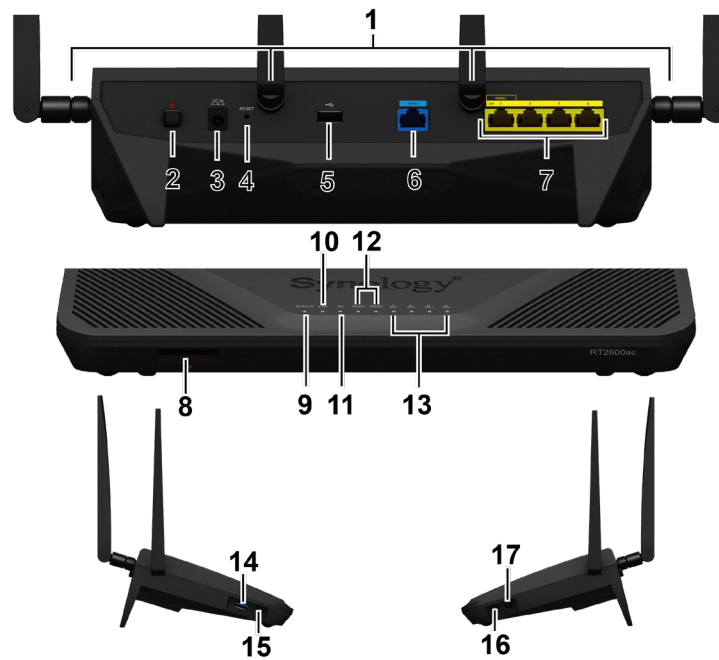



## RT2600ac at a Glance



No.	Article Name	Location	Description
1	Antenna Base	Rear Panel	Install the included antennas here.
2	Power Button		Press to power on/off the Synology Router.
3	Power Port		Connect the AC power adapter here.
4	RESET Button		Press and hold for four seconds (Soft Reset) or for ten seconds (Hard Reset).
5	USB 2.0 Port		Connect an external drive, USB printer, or other types of USB devices here.
6	WAN Port		Connect a network cable from the ISP modem into this port to establish WAN connection.
7	LAN Port		Connect network cables into these ports to establish LAN connection.
8	SD Card Slot	Front Panel	Insert the SD card here.
9	STATUS Indicator		Displays the status of the system.
10	2.4G Wi-Fi Indicator		Displays the status of 2.4G Wi-Fi connection.
11	5G Wi-Fi Indicator		Displays the status of 5G Wi-Fi connection.
12	WAN Indicator		Displays the status of WAN connection.
13	LAN Indicator		Displays the status of LAN connection.
14	USB 3.0 Port	Left Panel	Connect an external drive, USB printer, or other types of USB devices here.
15	Eject Button		1. Press to eject USB/SD external storages. 2. Displays the status of USB/SD external storages.
16	WPS Button	Right Panel	Press to start WPS.
17	Wi-Fi Button		Press to turn on/off the Wi-Fi network.

**Note:** For LED indicator information, please refer to "Appendix B: LED Indicator Table".

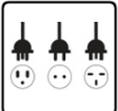
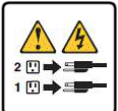
## Safety Instructions

	<p>Keep away from direct sunlight and away from chemicals. Make sure the environment does not experience abrupt changes in temperature or humidity.</p>
	<p>Place the product right side up at all times.</p>
	<p>Do not place near any liquids.</p>
	<p>Before cleaning, unplug the power cord. Wipe with damp paper towels. Do not use chemical or aerosol cleaners.</p>
	<p>To prevent the unit from falling over, do not place on carts or any unstable surfaces.</p>
	<p>The power cord must plug in to the correct supply voltage. Make sure that the supplied AC voltage is correct and stable.</p>
	<p>To remove all electrical current from the device, ensure that all power cords are disconnected from the power source.</p>
	<p>Risk of explosion if battery is replaced with an incorrect type. Dispose of used batteries appropriately.</p>

# Set up Your Synology Router

## Install Antennas

---

- 1 Point the antenna at the antenna base.
- 2 Turn clockwise until the antenna is secured.



- 3 Repeat Steps 1 and 2 to install the other antennas. For optimal Wi-Fi performance, tilt the antennas so that they are at a 90 degree angle to the surface.



## Position Your RT2600ac

For optimal performance, it is recommended to position your RT2600ac as advised below:

- On a stable surface (e.g. an elevated shelf) away from any possible physical interruptions.
- Close to the center of the area where the wired/wireless client devices are placed, and within a visible distance from the wireless devices.
- In a position where few walls and ceilings are between your RT2600ac and its client devices.
- Away from any potential electrical signal sources, such as other Wi-Fi routers, 3G/4G bases, and microwave ovens.
- Away from large expanses of metal or other materials, such as metal doors, glass panels, and concrete.

### Place Flat on a Surface

Simply place your RT2600ac flat on a horizontal, stable surface.

## Connect to Your RT2600ac

- 1 Use the included network cable to connect your RT2600ac (at the WAN1 port) to the ISP modem. Connect one end of the power adapter to the power port on your RT2600ac, and the other end to the power outlet. Press the power button to power on your RT2600ac. Wait for up to two minutes until the STATUS and WAN LED indicators turn green.

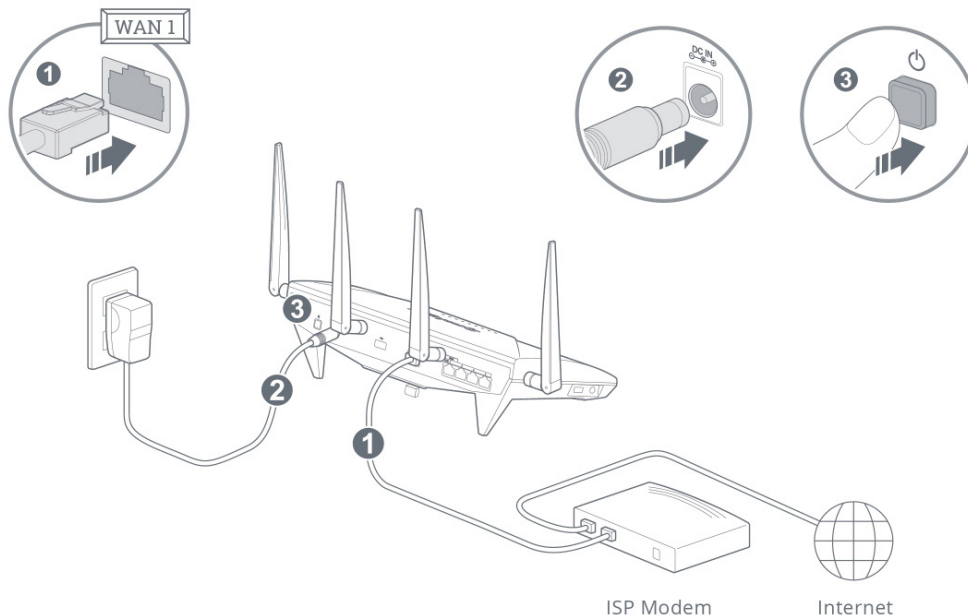

**Note:**

If you wish to use Smart WAN, connect your RT2600ac (at the WAN1 and LAN1 ports) to the ISP modem with network cables. The remaining LAN ports will be available for wired devices.

- 2 Connect wireless client devices to your RT2600ac. When the 2.4G/5G LED indicators have turned static green, RT2600ac is ready to connect with other devices. Use your wireless device to scan and join the Wi-Fi network created by your RT2600ac.

From laptop



- 1 

	Wi-Fi SSID: Synology_(Serial)
	Password: synology

- 2 

	http://router.synology.com
	http://192.168.1.1

- 3 Follow the setup wizard

From mobile device



- 1 

--	--	--	--

- 2 

	Wi-Fi SSID: Synology_(Serial)
	Password: synology

- 3 Follow the setup wizard

**Note:**

Below are the default credentials for the Wi-Fi network:

- Wi-Fi SSID: **Synology\_(Serial)**
- Password: **synology**

The default credentials can be changed during the initial SRM setup.

- 3 Connect wired client devices to your RT2600ac. Use network cables to connect devices to the LAN ports. The corresponding LAN LED indicators should turn orange/green to indicate successful connection.

From desktop computer

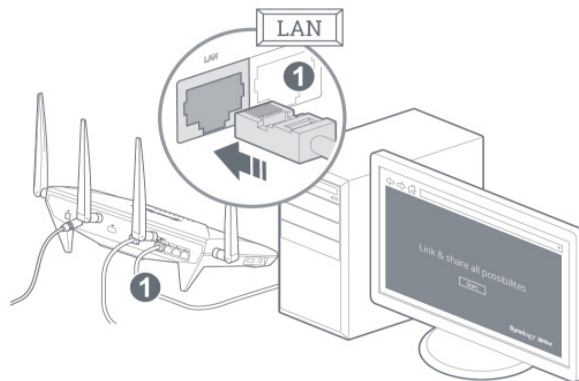

- 1 Connect computer to the router

- 2 

	http://router.synology.com
	http://192.168.1.1

- 3 Follow the setup wizard

## Set up Synology Router Manager (SRM)

---

- 1 Use a computer or wireless device connected to your RT2600ac's local network. If you use a wireless device, scan and join the Wi-Fi network (SSID: **Synology\_(Serial)**; Password: **synology**).
- 2 Open a web browser, and enter either URL into the address bar:
  - <http://router.synology.com>
  - <http://192.168.1.1:8000>
- 3 Once connected, click **Start** to launch the SRM Setup Wizard.

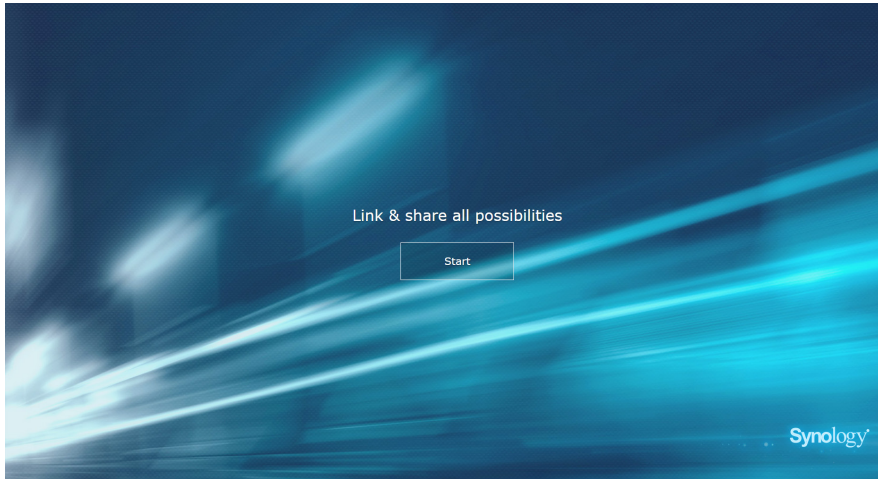

- 4 Fill in the information to set up the administrator account. Click **Next** to continue.

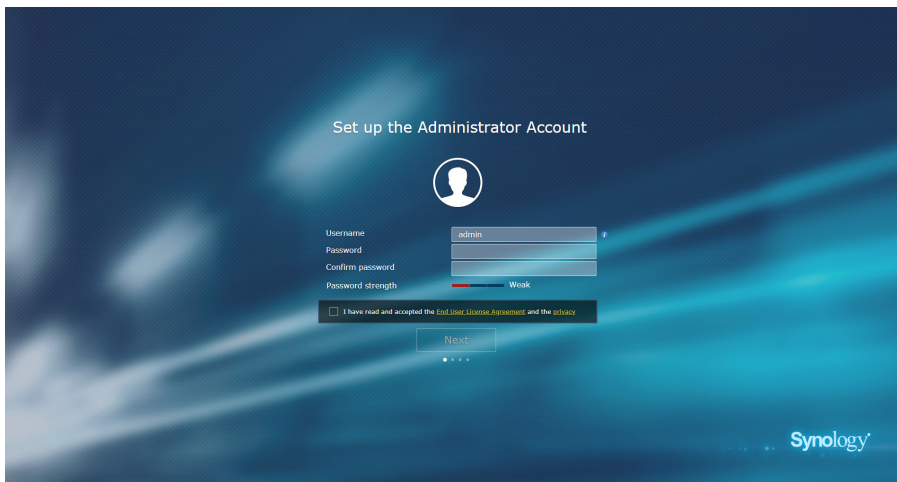

5 Fill in the information to set up the Wi-Fi network. Click **Next** to continue.

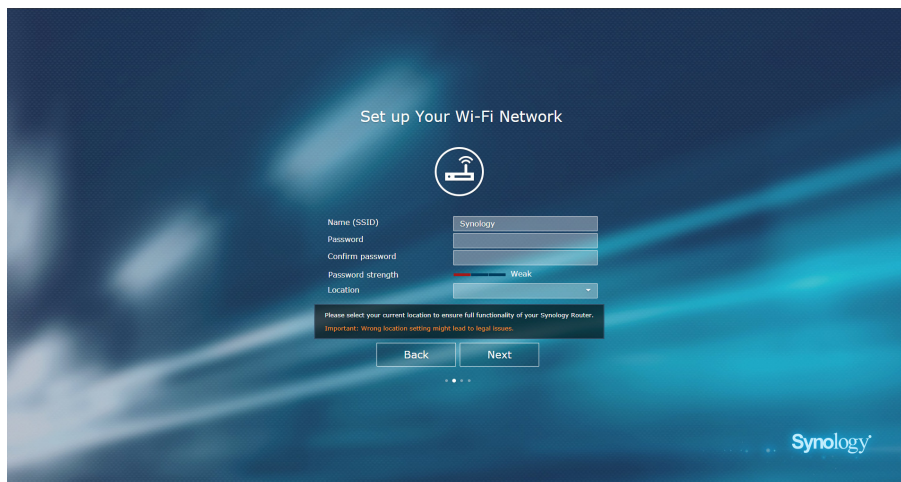

6 Set up the operation mode. When choosing the **Wireless Router** mode, you can also enable **External access to SRM** so that only external access via the HTTP(S) port (e.g. 8000/8001) can reach SRM.

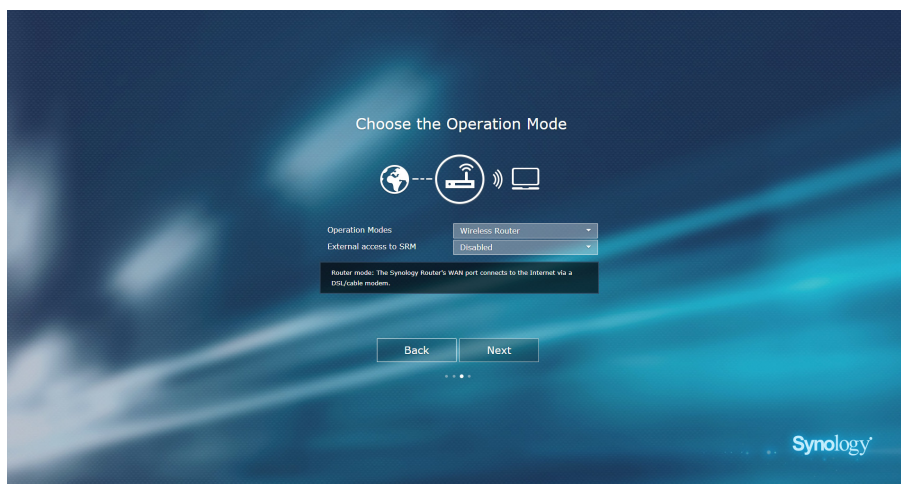

7 Choose an Internet connection type:

- **PPPoE**: Choose this option if you have obtained PPPoE credentials from the ISP.
- **Manual IP**: Choose this option if you have obtained an available IP address for use.
- **Auto IP**: Choose this option if you rely on an ISP modem for automatic IP assignment.

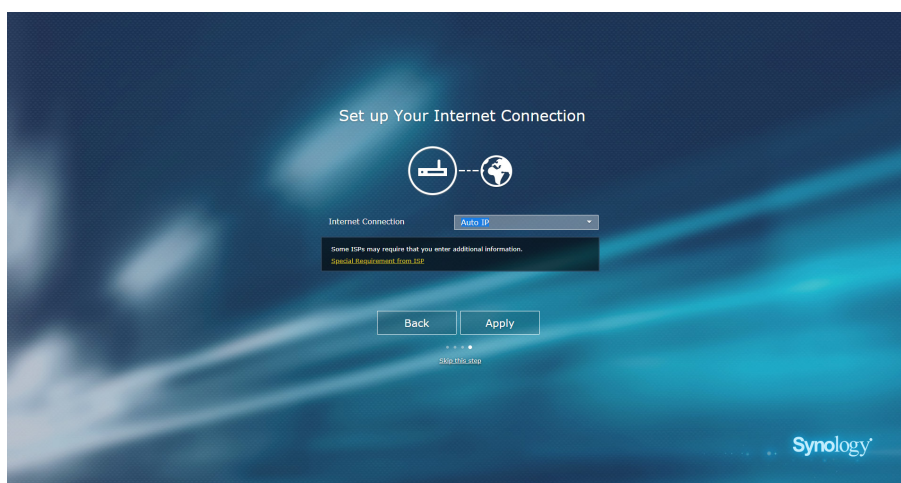

8 The wizard will continue to set up your RT2600ac, and it may take up to three minutes to complete the setup.

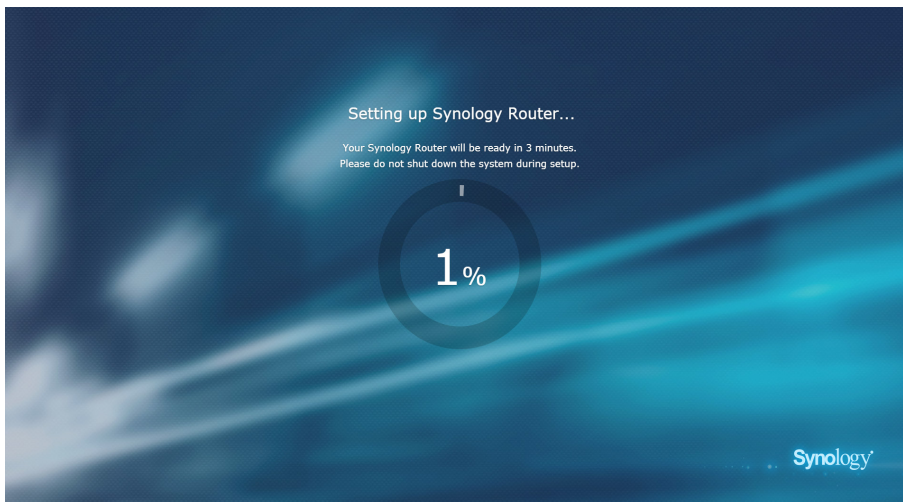

9 After the setup is complete, click **Start managing now** to enjoy SRM and its various features.

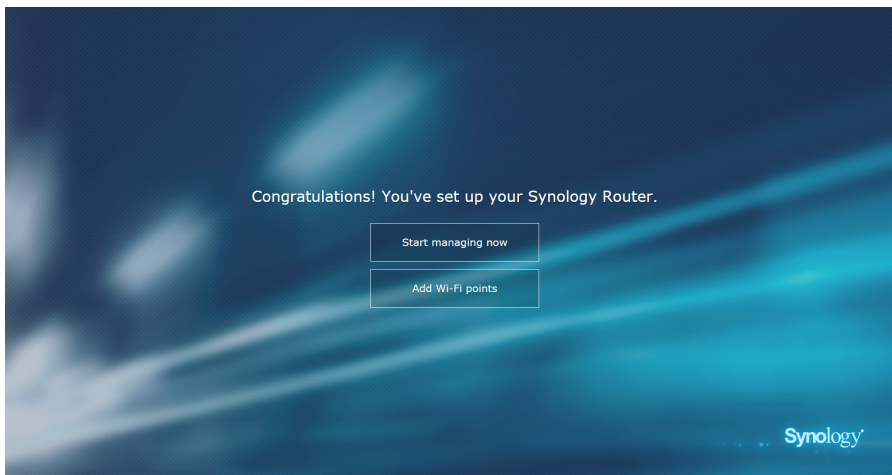

**Note:**

1. Above is a general demonstration of the SRM setup steps. The steps and available options may somewhat vary depending on your device type (e.g. PC or wireless device), access type (LAN, WAN, or Wireless LAN), and chosen operation mode (Wireless Router or Wireless AP).
2. If the setup is to be completed with a wireless device, remember to download DS router to manage your RT2600ac from anywhere.

# Specifications

Item	RT2600ac
External Ports	<ul style="list-style-type: none"> <li>• USB 3.0 x 1</li> <li>• USB 2.0 x 1</li> <li>• SD x 1</li> </ul>
WAN Port	Gigabit WAN x 1 or Gigabit WAN x 2 (Dual WAN)
LAN Ports	Gigabit LAN x 4 or Gigabit LAN x 3 (Dual WAN)
Size (H x W x D) (mm)	77 x 280 x 169 (without antennas)
Weight (kg)	0.695 kg
Supported Clients (for SRM management)	<ul style="list-style-type: none"> <li>• Windows 7 onwards</li> <li>• Mac OS X 10.10 onwards</li> </ul>
File Systems	External: EXT4, EXT3, FAT, NTFS, HFS+
Wireless Standards	<ul style="list-style-type: none"> <li>• 2.4GHz: 802.11 b/g/n</li> <li>• 5GHz: 802.11 a/n/ac</li> </ul>
Operating Frequency Range	<ul style="list-style-type: none"> <li>• 802.11n (2.4GHz): Up to 800 Mbps</li> <li>• 802.11ac (5GHz): Up to 1.73 Gbps</li> </ul>
Wireless Operation Modes	<ul style="list-style-type: none"> <li>• Wireless Router</li> <li>• Wireless AP (Access Point)</li> <li>• Wireless Repeater (WDS)</li> </ul>
Wireless Security	<ul style="list-style-type: none"> <li>• 64/128-bit WEP • WPS support</li> <li>• WPA2-Personal • WPA/WPA2-Personal</li> <li>• WPA2-Enterprise • WPA/WPA2-Enterprise</li> <li>• Opportunistic Wireless Encryption (OWE)</li> <li>• WPA3-Personal • WPA3-Enterprise</li> <li>• WPA2/WPA3-Personal</li> </ul>
Antennas	4T4R Omni-directional high-gain dipole (2.4GHz/5GHz)
Buttons & Switches	<ul style="list-style-type: none"> <li>• Power • WPS • Wi-Fi On/Off</li> <li>• Reset • USB/SD Eject</li> </ul>
Language Localization	<ul style="list-style-type: none"> <li>• English • Deutsch • Français • Italiano • Español • Dansk • Norsk • Svensk</li> <li>• Nederlands • Русский • Polski • Magyar • Português do Brasil • Português Europeu</li> <li>• Türkçe • Český • 日本語 • 한국어 • 繁體中文 • 简体中文</li> </ul>
Environment Requirements	<ul style="list-style-type: none"> <li>• Line voltage: 100V to 240V AC</li> <li>• Frequency: 50/60Hz</li> <li>• Operating Temperature: 40 to 104°F (5 to 40°C)</li> <li>• Storage Temperature: -5 to 140°F (-20 to 60°C)</li> <li>• Relative Humidity: 5% to 95% RH</li> </ul>

**Note:** Model specifications are subject to change without notice. Please refer to [www.synology.com](http://www.synology.com) for the latest information.

# LED Indicator Table

LED Indicator	Color	Status	Description
STATUS	Green	Static	Powered on
	Orange	Static	System booting / Rebooting / Hard Reset
		Blinking	Restoring settings (Soft Reset)
	Green / Orange	Blinking	Finding device
	Off		Powered off
Wi-Fi (2.4G & 5G)	Green	Static	Wi-Fi on
		Blinking	Wi-Fi active
	Off		No Wi-Fi
WAN	Green	Static	Network connected
		Blinking	Network active
	Off		No network
LAN (1-4)	Green	Static	Gigabit connection
		Blinking	Network active
	Orange	Static	10/100 Mbps connection
		Blinking	Network active
	Off		No network
USB/SD <sup>1</sup>	Green	Static	Storage detected
		Blinking	Transmitting data
	Orange	Static	Ready for removal
		Blinking	Ejecting storages
	Off		No storage
WPS	Green	Static	WPS ready
		Blinking	WPS connection in progress
	Off		WPS disabled

**Note:** Model specifications are subject to change without notice. Please refer to [www.synology.com](http://www.synology.com) for the latest information.

<sup>1</sup> The USB/SD LED does not reflect the status of the 3G/4G dongle or printer attached to your Synology Router

# 限用物質含有情況標示聲明書

Declaration of the Presence Condition of the Restricted Substances Marking

設備名稱：802.11ac 無線路由器，型號（型式）：RT2600ac																																				
Equipment name	Type designation (Type)																																			
單元 Unit	限用物質及其化學符號 Restricted substances and its chemical symbols																																			
	<table border="1"> <thead> <tr> <th>鉛Lead (Pb)</th> <th>汞Mercury (Hg)</th> <th>鎘Cadmium (Cd)</th> <th>六價鉻Hexavalent chromium (Cr<sup>+6</sup>)</th> <th>多溴聯苯Polybrominated biphenyls (PBB)</th> <th>多溴二苯醚Polybrominated diphenyl ethers (PBDE)</th> </tr> </thead> <tbody> <tr> <td>○</td> <td>○</td> <td>○</td> <td>○</td> <td>○</td> <td>○</td> </tr> <tr> <td>○</td> <td>○</td> <td>○</td> <td>○</td> <td>○</td> <td>○</td> </tr> <tr> <td>○</td> <td>○</td> <td>○</td> <td>○</td> <td>○</td> <td>○</td> </tr> <tr> <td>○</td> <td>○</td> <td>○</td> <td>○</td> <td>○</td> <td>○</td> </tr> <tr> <td>○</td> <td>○</td> <td>○</td> <td>○</td> <td>○</td> <td>○</td> </tr> </tbody> </table>	鉛Lead (Pb)	汞Mercury (Hg)	鎘Cadmium (Cd)	六價鉻Hexavalent chromium (Cr <sup>+6</sup> )	多溴聯苯Polybrominated biphenyls (PBB)	多溴二苯醚Polybrominated diphenyl ethers (PBDE)	○	○	○	○	○	○	○	○	○	○	○	○	○	○	○	○	○	○	○	○	○	○	○	○	○	○	○	○	○
鉛Lead (Pb)	汞Mercury (Hg)	鎘Cadmium (Cd)	六價鉻Hexavalent chromium (Cr <sup>+6</sup> )	多溴聯苯Polybrominated biphenyls (PBB)	多溴二苯醚Polybrominated diphenyl ethers (PBDE)																															
○	○	○	○	○	○																															
○	○	○	○	○	○																															
○	○	○	○	○	○																															
○	○	○	○	○	○																															
○	○	○	○	○	○																															
電路板	○ ○ ○ ○ ○ ○																																			
塑膠外殼	○ ○ ○ ○ ○ ○																																			
金屬散熱片	○ ○ ○ ○ ○ ○																																			
網路線	○ ○ ○ ○ ○ ○																																			
電源供應器	○ ○ ○ ○ ○ ○																																			
<p>備考1. “超出0.1 wt %” 及 “超出0.01 wt %” 係指限用物質之百分比含量超出百分比含量基準值。 Note 1 : “Exceeding 0.1 wt %” and “exceeding 0.01 wt %” indicate that the percentage content of the restricted substance exceeds the reference percentage value of presence condition.</p> <p>備考2. “○” 係指該項限用物質之百分比含量未超出百分比含量基準值。 Note 2 : “○” indicates that the percentage content of the restricted substance does not exceed the percentage of reference value of presence.</p> <p>備考3. “—” 係指該項限用物質為排除項目。 Note 3 : The “—” indicates that the restricted substance corresponds to the exemption.</p>																																				

## SYNOLOGY, INC. END USER LICENSE AGREEMENT

IMPORTANT—READ CAREFULLY: THIS END USER LICENSE AGREEMENT ("EULA") IS A LEGAL AGREEMENT BETWEEN YOU (EITHER AN INDIVIDUAL OR A LEGAL ENTITY) AND SYNOLOGY, INC. ("SYNOLOGY") FOR THE SYNOLOGY SOFTWARE INSTALLED ONTO THE SYNOLOGY PRODUCT PURCHASED BY YOU (THE "PRODUCT"), OR LEGALLY DOWNLOADED FROM [WWW.SYNOLOGY.COM](http://WWW.SYNOLOGY.COM), OR ANY OTHER CHANNEL PROVIDED BY SYNOLOGY ("SOFTWARE").

YOU AGREE TO BE BOUND BY THE TERMS OF THIS EULA BY USING THE PRODUCTS CONTAINING THE SOFTWARE, INSTALLING THE SOFTWARE ONTO THE PRODUCTS OR DEVICE CONNECTED TO THE PRODUCTS. IF YOU DO NOT AGREE TO THE TERMS OF THIS EULA, DO NOT USE THE PRODUCTS CONTAINING THE SOFTWARE OR DOWNLOAD THE SOFTWARE FROM [WWW.SYNOLOGY.COM](http://WWW.SYNOLOGY.COM), OR ANY OTHER CHANNEL PROVIDED BY SYNOLOGY. INSTEAD, YOU MAY RETURN THE PRODUCT TO THE RESELLER WHERE YOU PURCHASED IT FOR A REFUND IN ACCORDANCE WITH THE RESELLER'S APPLICABLE RETURN POLICY.

Section 1. Limited Software License. Subject to the terms and conditions of this EULA, Synology grants you a limited, non-exclusive, non-transferable, personal license to install, run and use one copy of the Software loaded on the Product or on your device connected to the Product solely relating to your authorized use of the Product.

Section 2. Documentation. You may make and use a reasonable number of copies of any documentation provided with the Software; provided that such copies will only be used for internal business purposes and are not to be republished or redistributed (either in hard copy or electronic form) to any third party.

Section 3. Backup. You may make a reasonable number of copies of the Software for backup and archival purposes only.

Section 4. Updates. Any software provided to you by Synology or made available on the Synology website at [www.synology.com](http://www.synology.com) ("Website") or any other channel provided by Synology that updates or supplements the original Software is governed by this EULA unless separate license terms are provided with such updates or supplements, in which case, such separate terms will govern.

Section 5. License Limitations. The license set forth in Sections 1, 2 and 3 applies only to the extent that you have ordered and paid for the Product and states the entirety of your rights with respect to the Software. Synology reserves all rights not expressly granted to you in this EULA. Without limiting the foregoing, you shall not authorize or permit any third party to: (a) use the Software for any purpose other than that in connection with the Product; (b) license, distribute, lease, rent, lend, transfer, assign or otherwise dispose of the Software; (c) reverse engineer, decompile, disassemble or attempt to discover the source code of or any trade secrets related to the Software, except and only to the extent that such conduct is expressly permitted by applicable law notwithstanding this limitation; (d) adapt, modify, alter, translate or create any derivative works of the Software; (e) remove, alter or obscure any copyright notice or other proprietary rights notice on the Software or Product; or (f) circumvent or attempt to circumvent any methods employed by Synology to control access to the components, features or functions of the Product or Software. Subject to the limitations specified in this Section 5, you are not prohibited from providing any services hosted by Synology NAS server to any third party for commercial purpose.

Section 6. Open Source. The Software may contain components licensed to Synology under the GNU General Public License ("GPL Components"), currently available at <http://www.gnu.org/licenses/gpl.html>. The terms of the GPL will control solely with respect to the GPL Components to the extent that this EULA conflicts with the requirements of the GPL with respect to your use of the GPL Components, and, in such event, you agree to be bound by the GPL with respect to your use of such components.

Section 7. Audit. Synology will have the right to audit your compliance with the terms of this EULA. You agree to grant Synology a right to access to your facilities, equipment, books, records and documents and to otherwise reasonably cooperate with Synology in order to facilitate any such audit by Synology or its agent authorized by Synology.

Section 8. Ownership. The Software is a valuable property of Synology and its licensors, protected by copyright and other intellectual property laws and treaties. Synology or its licensors own all rights, titles and interests in and to the Software, including but not limited to copyright and any other intellectual property rights.

Section 9. Limited Warranty. Synology provides a limited warranty that the Software will substantially conform to Synology's published specifications for the Software, if any, or otherwise set forth on the Website, for a period required by your local law. Synology will use commercially reasonable efforts to, in Synology's sole discretion, either correct any such nonconformity in the Software or replace any Software that fails to comply with the foregoing warranty, provided that you give Synology written notice of such noncompliance within the warranty period. The foregoing warranty does not apply to any noncompliance resulting from any: (w) use, reproduction, distribution or disclosure not in accordance with this EULA; (x) any customization, modification or other alteration of the Software by anyone other than Synology; (y) combination of the Software with any product, services or other items provided by anyone other than Synology; or (z) your failure to comply with this EULA.

Section 10. Support. During the period specified in the Section 9, Synology will make available to you the support services. Following the expiration of the applicable period, support for Software may be available from Synology upon written

request.

Section 11. Disclaimer of Warranties. EXCEPT AS EXPRESSLY SET FORTH ABOVE, THE SOFTWARE IS PROVIDED "AS IS" AND WITH ALL FAULTS. SYNOLOGY AND ITS SUPPLIERS HEREBY DISCLAIM ALL OTHER WARRANTIES, EXPRESS, IMPLIED OR STATUTORY, ARISING BY LAW OR OTHERWISE, INCLUDING BUT NOT LIMITED TO ANY IMPLIED WARRANTIES OF MERCHANTABILITY, FITNESS FOR A PARTICULAR PURPOSE OR USE, TITLE AND NONINFRINGEMENT, WITH REGARD TO THE SOFTWARE. WITHOUT LIMITING THE FOREGOING, SYNOLOGY DOES NOT WARRANT THAT THE SOFTWARE WILL BE FREE OF BUGS, ERRORS, VIRUSES OR OTHER DEFECTS.

Section 12. Disclaimer of Certain Damages. IN NO EVENT WILL SYNOLOGY OR ITS LICENSORS BE LIABLE FOR ANY INCIDENTAL, INDIRECT, SPECIAL, PUNITIVE, CONSEQUENTIAL OR SIMILAR DAMAGES OR LIABILITIES WHATSOEVER (INCLUDING, BUT NOT LIMITED TO LOSS OF DATA, INFORMATION, REVENUE, PROFIT OR BUSINESS) ARISING OUT OF OR RELATING TO THE USE OF OR INABILITY TO USE THE SOFTWARE OR OTHERWISE UNDER OR IN CONNECTION WITH THIS EULA OR THE SOFTWARE, WHETHER BASED ON CONTRACT, TORT (INCLUDING NEGLIGENCE), STRICT LIABILITY OR OTHER THEORY EVEN IF SYNOLOGY HAS BEEN ADVISED OF THE POSSIBILITY OF SUCH DAMAGES.

Section 13. Limitation of Liability. SYNOLOGY'S AND ITS SUPPLIERS' LIABILITY ARISING OUT OF OR RELATING TO THE USE OF OR INABILITY TO USE THE SOFTWARE OR OTHERWISE UNDER OR IN CONNECTION WITH THIS EULA OR THE SOFTWARE IS LIMITED TO THE AMOUNT ACTUALLY PAID BY YOU FOR THE PRODUCT REGARDLESS OF THE AMOUNT OF DAMAGES YOU MAY INCUR AND WHETHER BASED ON CONTRACT, TORT (INCLUDING NEGLIGENCE), STRICT LIABILITY OR OTHER THEORY. The foregoing disclaimer of warranties, disclaimer of certain damages and limitation of liability will apply to the maximum extent permitted by applicable law. The laws of some states/jurisdictions do not allow the exclusion of implied warranties or the exclusion or limitation of certain damages. To the extent that those laws apply to this EULA, the exclusions and limitations set forth above may not apply to you.

Section 14. Export Restrictions. You acknowledge that the Software is subject to U.S. export restrictions. You agree to comply with all applicable laws and regulations that apply to the Software, including without limitation the U.S. Export Administration Regulations.

Section 15. Termination. Without prejudice to any other rights, Synology may terminate this EULA if you do not abide by the terms and conditions contained herein. In such event, you must cease use of the Software and destroy all copies of the Software and all of its component parts.

Section 16. Assignment. You may not transfer or assign your rights under this EULA to any third party, except for that pre-installed in the Products. Any such transfer or assignment in violation of the foregoing restriction will be void.

Section 17. Applicable Law. Unless expressly prohibited by local law, this EULA is governed by and construed in accordance with the laws of the country, in accordance with which Synology Inc. was organized without regard to any conflict of law principles to the contrary.

Section 18. Dispute Resolution. Any dispute, controversy or claim arising out of or relating to this EULA will be resolved exclusively and finally by arbitration conducted by three neutral arbitrators in accordance with the procedures of the Arbitration Law and related enforcement rules of the country in which Synology Inc. was organized. In such cases, the arbitration will be limited solely to the dispute between you and Synology. The arbitration, or any portion of it, will not be consolidated with any other arbitration and will not be conducted on a class-wide or class action basis. The arbitration shall take place in Taipei and the arbitration proceedings shall be conducted in English or, if both parties so agree, in Mandarin Chinese. The arbitration award shall be final and binding on the parties and may be enforced in any court having jurisdiction. You understand that, in the absence of this provision, you would have had a right to litigate any such dispute, controversy or claim in a court, including the right to litigate claims on a class-wide or class-action basis, and you expressly and knowingly waives those rights and agrees to resolve any disputes through binding arbitration in accordance with the provisions of this Section 18. Nothing in this Section shall be deemed to prohibit or restrict Synology from seeking injunctive relief or seeking such other rights and remedies as it may have at law or equity for any actual or threatened breach of any provision of this EULA relating to Synology's intellectual property rights.

Section 19. Attorneys' Fees. In any arbitration, mediation, or other legal action or proceeding to enforce rights or remedies under this EULA, the prevailing party will be entitled to recover, in addition to any other relief to which it may be entitled, costs and reasonable attorneys' fees.

Section 20. Severability. If any provision of this EULA is held by a court of competent jurisdiction to be invalid, illegal, or unenforceable, the remainder of this EULA will remain in full force and effect.

Section 21. Entire Agreement. This EULA sets forth the entire agreement of Synology and you with respect to the Software and the subject matter hereof and supersedes all prior and contemporaneous understandings and agreements whether written or oral. No amendment, modification or waiver of any of the provisions of this EULA will be valid unless set forth in a written instrument signed by the party to be bound thereby.

## SYNOLOGY, INC. LIMITED PRODUCT WARRANTY

THIS LIMITED WARRANTY ("WARRANTY") APPLIES TO THE PRODUCTS (AS DEFINED BELOW) OF SYNOLOGY, INC. AND ITS AFFILIATES, INCLUDING SYNOLOGY AMERICA CORP, (COLLECTIVELY, "SYNOLOGY"). YOU ACCEPT AND AGREE TO BE BOUND BY THE TERMS OF THIS WARRANTY BY OPENING THE PACKAGE CONTAINING AND/OR USING THE PRODUCT. IF YOU DO NOT AGREE TO THE TERMS OF THIS WARRANTY, DO NOT USE THE PRODUCT. INSTEAD, YOU MAY RETURN THE PRODUCT TO THE RESELLER WHERE YOU PURCHASED IT FOR A REFUND IN ACCORDANCE WITH THE RESELLER'S APPLICABLE RETURN POLICY.

### Section 1. Products

- (a) "Products" refer to New Products or Refurbished Products.
- (b) "New Product", includes: (1) "Category I Product" means Synology product models RS810+, RS810RP+, RX410, all FS-series models, all DS/RS NAS models with the XS+/XS suffix (except RS3413xs+) in or after 13-series, all DX/RX/RXD expansion units with 12 or more drive bays in or after 13-series, 10GbE NIC, ECC DDR4 and ECC DDR3 memory modules. (2) "Category II Product" means Synology product models RS3413xs+, RS3412xs, RS3412RPxs, RS3411xs, RS3411RPxs, RS2211+, RS2211RP+, RS411, RS409RP+, RS409+, RS409, RS408-RP, RS408, RS407, DS3612xs, DS3611xs, DS2411+, DS1511+, DS1010+, DS509+, DS508, EDS14, RX1211, RX1211RP, RX4, DX1211, DX510, DX5, NVR1218, NVR216, VS960HD, VS360HD, VS240HD, M2D17, and all other non-ECC memory modules not included in Category I. (3) "Category III Product" means Synology product models that match the following requirements: all DS NAS models without the XS+/XS suffix and with 5 and more drive bays in or after 12-series, all RS NAS models without the XS+/XS suffix in or after 12-series, and all DX/RX expansion units with 4 or 5 drive bays in or after 12-series. (4) "Category IV Product" means all other Synology product models purchased by Customer after March 1, 2008. (5) "Category V Product" means all other Synology product models purchased by Customer before February 29, 2008 and any "spare parts" purchased directly from Synology.
- (c) "Refurbished Product" means all Synology products which have been refurbished and sold directly by Synology through Online Store, not including those sold by an authorized Synology distributor or reseller.
- (d) Other definition: "Customer" means the original person or entity purchasing the Product from Synology or an authorized Synology distributor or reseller; "Online Store" means an online shop operated by Synology or Synology's affiliate; "Software" means the Synology proprietary software that accompanies the Product when purchased by Customer, is downloaded by Customer from the Web Site, or is pre-installed on the Product by Synology, and includes any firmware, associated media, images, animations, video, audio, text and applets incorporated into the software or Product and any updates or upgrades to such software.

### Section 2. Warranty Period

- (a) "Warranty Period" : The warranty period commences on the date the Product is purchased by customer and ending (1) five years after such date for Category I Products; (2) three years after such date for Category II & III Products; (3) two years after such date for Category IV Products; (4) one year after such date for Category V Products; or (5) 90 days after such date for Refurbished Products, except for those sold as "as is" or with "no warranty" on Online Store.
- (b) "Extended Warranty Period" : For Customer purchasing EW201 optional service for applicable Products specified in Section 1 (b), the Warranty Period specified in Section 2 (a) of the applicable Product registered with EW201 optional service will be extended by two years.

### Section 3. Limited Warranty and Remedies

3.1 Limited Warranty. Subject to Section 3.6, Synology warrants to the Customer that each Product (a) will be free of material defects in workmanship and (b) under normal use will perform substantially in accordance with Synology's published specifications for the Product during the Warranty Period. Such limited warranty does not apply to the Software which shall be subject to the accompanying end user license agreement provided with the Product, if any. Synology provides no warranty to Refurbished Product sold as "as is" or with "no warranty" on Online Store.

3.2 Exclusive Remedy. If Customer gives notice of noncompliance with any of the warranties set forth in Section 3.1 within the applicable Warranty Period in the manner set forth below, then, upon verification of the noncompliance by Synology, Synology will, at Synology's option: (a) use commercially reasonable efforts to repair the Product, or (b) replace the noncomplying Product or part thereof upon return of the complete Product in accordance with Section 3.3 The foregoing sets forth Synology's entire liability and Customer's sole and exclusive remedy for any breach of warranty under Section 3.1 or any other defect or deficiency in the Product. Customer will reasonably assist Synology to diagnose and validate any nonconformity with the Product. The warranty set forth in Section 3.1 does not include: (1) any warranty relating to the Software; (2) physical installation or removal of the Product from Customer's site; (3) visits to Customer's site; (4) labor necessary to effect repairs or replace defective parts other than during Synology's or its contracted service providers' normal local business hours, exclusive of weekends and service providers' holidays; (5) any work with any third party equipment or software; (6) any warranty of the hard disk if installed by Customer or any other third party; or (7) any warranty of compatibility with the hard disk.

3.3 Return. Any Product returned by Customer under Section 3.2 must be assigned a Return Merchandise Authorization

("RMA") number by Synology before shipment and must be returned in accordance with Synology's then current RMA procedures. Customer may contact any authorized Synology distributor or reseller or Synology Support to obtain assistance in obtaining an RMA, and must provide proof of purchase and product serial number when asking for such assistance. For warranty claims, Customer must return the complete Product to Synology in accordance with this Section 3.3 to be eligible for coverage under this Warranty. Any Product returned without an RMA number, or any Product that has been disassembled (except under the direction of Synology) will be refused and returned to Customer at Customer's expense. Any Product that has been assigned a RMA number must be returned in the same condition as it was received from Synology to the address designated by Synology, freight pre-paid, in packaging sufficient to protect the contents thereof and with the RMA number prominently displayed on the outside of the box. Customer is responsible for insurance and risk of loss with respect to returned items until they are properly received by Synology. A Product with a RMA number must be returned within fifteen (15) days after issuance of the applicable RMA number.

3.4 Replacement by Synology. If Synology elects to replace any Product under this Warranty set forth in Section 3.1, then Synology will ship a replacement Product at Synology's expense via the shipping method selected by Synology after receipt of the nonconforming Product returned in accordance with Section 3.3 and validation by Synology that the Product does not conform to the warranty. In some countries, Synology may at its own discretion apply the Synology Replacement Service to certain Products, through which Synology will ship a replacement Product to Customer before its receipt of the nonconforming Product returned by Customer ("Synology Replacement Service").

3.5 Support. During the Warranty Period, Synology will make available to Customer the support services. Following the expiration of the applicable Warranty Period, support for Products may be available from Synology upon written request.

3.6 Exclusions. The foregoing warranties and warranty obligations do not apply to any Product that (a) has been installed or used in a manner not specified or described in the Product specifications; (b) has been repaired, modified or altered by anyone other than Synology or its agent or designee; (c) has been in any way misused, abused, or damaged; (d) has been used with items not provided by Synology other than the hardware or software for which the Product is designed; or (e) otherwise fails to conform to the Product specifications and such failure is attributable to causes not within or under Synology's control. Further, the foregoing warranties will be void if (1) Customer disassembles the Product except as authorized by Synology; (2) Customer fails to implement any correction, modification, enhancement, improvement or other update made available to Customer by Synology; or (3) Customer implements, installs or uses any correction, modification, enhancement, improvement or other update made available by any third party. The warranty set forth in Section 3 will terminate upon Customer's sale or transfer of the Product to a third party.

3.7 Disclaimer of Warranties. THE WARRANTIES, OBLIGATIONS, AND LIABILITIES OF SYNOLOGY AND THE REMEDIES OF CUSTOMER SET FORTH IN THIS WARRANTY ARE EXCLUSIVE AND IN SUBSTITUTION FOR, AND CUSTOMER HEREBY WAIVES, RELEASES AND DISCLAIMS, ALL OTHER WARRANTIES, OBLIGATIONS AND LIABILITIES OF SYNOLOGY AND ALL OTHER RIGHTS, CLAIMS AND REMEDIES OF CUSTOMER AGAINST SYNOLOGY, EXPRESS OR IMPLIED, ARISING BY LAW OR OTHERWISE, WITH RESPECT TO THE PRODUCT, ACCOMPANYING DOCUMENTATION OR SOFTWARE AND ANY OTHER GOODS OR SERVICES DELIVERED UNDER THIS WARRANTY, INCLUDING, BUT NOT LIMITED TO ANY: (A) IMPLIED WARRANTY OF MERCHANTABILITY OR FITNESS FOR A PARTICULAR PURPOSE OR USE; (B) IMPLIED WARRANTY ARISING FROM COURSE OF PERFORMANCE, COURSE OF DEALING, OR USAGE OF TRADE; (C) CLAIM OF INFRINGEMENT OR MISAPPROPRIATION; OR (D) CLAIM IN TORT (WHETHER BASED ON NEGLIGENCE, STRICT LIABILITY, PRODUCT LIABILITY OR OTHER THEORY). SYNOLOGY MAKES NO GUARANTEE AND SPECIFICALLY DISCLAIMS ANY WARRANTY THAT THE DATA OR INFORMATION STORED ON ANY SYNOLOGY PRODUCT WILL BE SECURE AND WITHOUT RISK OF DATA LOSS. SYNOLOGY RECOMMENDS THAT CUSTOMER TAKES APPROPRIATE MEASURES TO BACK UP THE DATA STORED ON THE PRODUCT. SOME STATES/JURISDICTIONS DO NOT ALLOW LIMITATIONS ON IMPLIED WARRANTIES, SO THE ABOVE LIMITATION MAY NOT APPLY TO CUSTOMER.

#### Section 4. Limitations of Liability

4.1 Force Majeure. Synology will not be liable for, or be considered to be in breach of or default under this Warranty on account of, any delay or failure to perform as required by this Warranty as a result of any cause or condition beyond its reasonable control (including, without limitation, any act or failure to act by Customer).

4.2 Disclaimer of Certain Damages. IN NO EVENT WILL SYNOLOGY OR ITS SUPPLIERS BE LIABLE FOR THE COST OF COVER OR FOR ANY INCIDENTAL, INDIRECT, SPECIAL, PUNITIVE, CONSEQUENTIAL OR SIMILAR DAMAGES OR LIABILITIES WHATSOEVER (INCLUDING, BUT NOT LIMITED TO LOSS OF DATA, INFORMATION, REVENUE, PROFIT OR BUSINESS) ARISING OUT OF OR RELATING TO THE USE OR INABILITY TO USE THE PRODUCT, ANY ACCOMPANYING DOCUMENTATION OR SOFTWARE AND ANY OTHER GOODS OR SERVICES PROVIDED UNDER THIS WARRANTY, WHETHER BASED ON CONTRACT, TORT (INCLUDING NEGLIGENCE), STRICT LIABILITY OR OTHER THEORY EVEN IF SYNOLOGY HAS BEEN ADVISED OF THE POSSIBILITY OF SUCH DAMAGES.

4.3 Limitation of Liability. SYNOLOGY'S AND ITS SUPPLIERS' LIABILITY ARISING OUT OF OR RELATING TO THE

USE OR INABILITY TO USE THE PRODUCT, ANY ACCOMPANYING DOCUMENTATION OR SOFTWARE AND ANY OTHER GOODS OR SERVICES PROVIDED UNDER THIS WARRANTY IS LIMITED TO THE AMOUNT ACTUALLY PAID BY CUSTOMER FOR THE PRODUCT REGARDLESS OF THE AMOUNT OF DAMAGES CUSTOMER MAY INCUR AND WHETHER BASED ON CONTRACT, TORT (INCLUDING NEGLIGENCE), STRICT LIABILITY OR OTHER THEORY. The foregoing disclaimer of certain damages and limitation of liability will apply to the maximum extent permitted by applicable law. The laws of some states/jurisdictions do not allow exclusion or limitation of certain damages. To the extent that those laws apply to the Product, the exclusions and limitations set forth above may not apply to Customer.

## Section 5. Miscellaneous

5.1 Proprietary Rights. The Product and any accompanying Software and documentation provided with the Product include proprietary and intellectual property rights of Synology and its third party suppliers and licensors. Synology retains and reserves all right, title, and interest in the intellectual property rights of the Product, and no title to or ownership of any intellectual property rights in or to the Product, any accompanying Software or documentation and any other goods provided under this Warranty is transferred to Customer under this Warranty. Customer will (a) comply with the terms and conditions of the Synology end user license agreement accompanying any Software furnished by Synology or an authorized Synology distributor or reseller; and (b) not attempt to reverse engineer any Product or component thereof or accompanying Software or otherwise misappropriate, circumvent or violate any of Synology's intellectual property rights.

5.2 Assignment. Customer will not assign any of its rights under this Warranty directly, by operation of law or otherwise, without the prior written consent of Synology.

5.3 No Additional Terms. Except as expressly permitted by this Warranty, neither party will be bound by, and each party specifically objects to, any term, condition or other provision that conflicts with the provisions of this Warranty that is made by the other party in any purchase order, receipt, acceptance, confirmation, correspondence or otherwise, unless each party specifically agrees to such provision in writing. Further, if this Warranty conflicts with any terms or conditions of any other agreement entered into by the parties with respect to the Product, this Warranty will prevail unless the other agreement specifically references the sections of this Warranty that it supersedes.

5.4 Applicable Law. Unless explicitly prohibited by local law, this Warranty is governed by the laws of the State of Washington, U.S.A. for the Customers residing within the United States; and by the laws of the Republic of China (Taiwan) for Customers not residing within the United States, without regard to any conflict of law principles to the contrary. The 1980 U.N. Convention on Contracts for the International Sale of Goods or any successor thereto does not apply.

5.5 Dispute Resolution. Any dispute, controversy or claim arising out of or relating to this Warranty, the Product or services provided by Synology with respect to the Product or the relationship between Customers residing within the United States and Synology will be resolved exclusively and finally by arbitration under the current commercial rules of the American Arbitration Association, except as otherwise provided below. The arbitration will be conducted before a single arbitrator, and will be limited solely to the dispute between Customer and Synology. The arbitration, or any portion of it, will not be consolidated with any other arbitration and will not be conducted on a class-wide or class action basis. The arbitration shall be held in King County, Washington, U.S.A. by submission of documents, by telephone, online or in person as determined by the arbitrator at the request of the parties. The prevailing party in any arbitration or legal action occurring within the United States or otherwise shall receive all costs and reasonable attorneys' fees, including any arbitration fee paid by the prevailing party. Any decision rendered in such arbitration proceedings will be final and binding on the parties, and judgment may be entered thereon in any court of competent jurisdiction. Customer understands that, in the absence of this provision, Customer would have had a right to litigate any such dispute, controversy or claim in a court, including the right to litigate claims on a class-wide or class-action basis, and Customer expressly and knowingly waives those rights and agrees to resolve any disputes through binding arbitration in accordance with the provisions of this Section 5.5. For Customers not residing within the United States, any dispute, controversy or claim described in this section shall be finally resolved by arbitration conducted by three neutral arbitrators in accordance with the procedures of the R.O.C. Arbitration Law and related enforcement rules. The arbitration shall take place in Taipei, Taiwan, R.O.C., and the arbitration proceedings shall be conducted in English or, if both parties so agree, in Mandarin Chinese. The arbitration award shall be final and binding on the parties and may be enforced in any court having jurisdiction. Nothing in this Section shall be deemed to prohibit or restrict Synology from seeking injunctive relief or seeking such other rights and remedies as it may have at law or equity for any actual or threatened breach of any provision of this Warranty relating to Synology's intellectual property rights.

5.6 Attorneys' Fees. In any arbitration, mediation, or other legal action or proceeding to enforce rights or remedies under this Warranty, the prevailing party will be entitled to recover, in addition to any other relief to which it may be entitled, costs and reasonable attorneys' fees.

5.7 Export Restrictions. You acknowledge that the Product may be subject to U.S. export restrictions. You will comply with all applicable laws and regulations that apply to the Product, including without limitation the U.S. Export Administration Regulations.

5.8 Severability. If any provision of this Warranty is held by a court of competent jurisdiction to be invalid, illegal, or unenforceable, the remainder of this Warranty will remain in full force and effect.

5.9 Entire Agreement. This Warranty constitutes the entire agreement, and supersedes any and all prior agreements, between Synology and Customer related to the subject matter hereof. No amendment, modification or waiver of any of the provisions of this Warranty will be valid unless set forth in a written instrument signed by the party to be bound thereby.

## **FCC Declaration of Conformity**

This device complies with Part 15 of the FCC Rules. Operation is subject to the following two conditions: (1) this device may not cause harmful interference, and (2) this device must accept any interference received, including interference that may cause undesired operation.

この装置は、クラス B 機器です。この装置は、住宅環境で使用することを目的としていますが、この装置がラジオやテレビジョン受信機に近接して使用されると、受信障害を引き起こすことがあります。

取扱説明書に従って正しい取り扱いをして下さい。

VCCI — B

1. 상호명: Synology Inc.
- 2.기자재 명칭 : 특정소출력무선기기
- 3.모델명 : RT2600ac
- 4.제조자 : Synology Inc.
- 5.제조국가 : 대만



R-CMM-Syn-RT2600ac

## EU Declaration of Conformity

Languages	Statement
<b>English</b>	<p>Declaration of Conformity for the Radio Equipment Directive 2014/53/EU</p> <p>Hereby, Synology Inc. declares that this Wireless Router is in compliance with the essential requirements and other relevant provisions of Directive 2014/53/EU.</p> <p>The full text of the EU declaration of conformity is available at the following internet address: <a href="https://www.synology.com/support/download/RT2600ac">https://www.synology.com/support/download/RT2600ac</a></p> <p>All operational modes:            2.4GHz: 802.11b, 802.11g, 802.11n (HT20), 802.11n (HT40)            5GHz: 802.11a, 802.11ac (VHT20), 802.11ac (VHT40), 802.11ac (VHT80)</p> <p>The frequency, mode and the maximum transmitted power in EU are listed below:            2400 MHz – 2483.5 MHz: 19.97 dBm (EIRP)            5150 MHz – 5250 MHz: 22.96 dBm (EIRP)            5250 MHz – 5350 MHz: 22.85 dBm (EIRP)            5470 MHz – 5725 MHz: 29.99 dBm (EIRP)            5150 to 5350 MHz is restricted to indoor.</p> <p>This equipment complies with EU radiation exposure limits set forth for an uncontrolled environment. This equipment should be installed and operated with minimum distance 20cm between the radiator &amp; your body.</p>
<b>Danish</b>	<p>Erklæring om overholdelse af radioudstørsdirektivet 2014/53/EF</p> <p>Herved erklærer Synology Inc., at firmaets trådløse router overholder de vigtigste krav og andre relevante bestemmelser i direktivet 2014/53/EF.</p> <p>Den fulde tekst i EU-overholdelseserklæringen findes på følgende internetadresse: <a href="https://www.synology.com/support/download/RT2600ac">https://www.synology.com/support/download/RT2600ac</a></p> <p>Alle driftstilstande:            2,4 GHz: 802.11b, 802.11g, 802.11n (HT20), 802.11n (HT40)            5 GHz: 802.11a, 802.11ac (VHT20), 802.11ac (VHT40), 802.11ac (VHT80)</p> <p>Frekvensen, tilstanden og den maksimale overførte effekt i EU vises nedenfor:            2400 MHz – 2483,5 MHz: 19,97 dBm (EIRP)            5150 MHz – 5250 MHz: 22,96 dBm (EIRP)            5250 MHz – 5350 MHz: 22,85 dBm (EIRP)            5470 MHz – 5725 MHz: 29,99 dBm (EIRP)            5150 til 5350 MHz er begrænset til indendøre.</p> <p>Dette udstyr overholder EU's grænser for strålingseksponering angivet for et ukontrolleret miljø. Dette udstyr skal installeres og drives med min. afstand på 20 cm mellem stråleenheden og din krop.</p>

<p><b>German</b></p>	<p>Konformitätserklärung für die Funkanlagen-Richtlinie 2014/53/EU</p> <p>Hiermit erklärt Synology Inc., dass dieser WLAN-Router den grundlegenden Anforderungen und anderen Vorschriften der Richtlinie 2014/53/EU entspricht.</p> <p>Der vollständige Wortlaut der EU-Konformitätserklärung steht unter der folgenden Internetadresse zur Verfügung:  <a href="https://www.synology.com/support/download/RT2600ac">https://www.synology.com/support/download/RT2600ac</a></p> <p>Alle Betriebsmodi:  2,4GHz: 802.11b, 802.11g, 802.11n (HT20), 802.11n (HT40)  5 GHz: 802.11a, 802.11ac (VHT20), 802.11ac (VHT40), 802.11ac (VHT80)</p> <p>Die Frequenz, der Modus und der max. übertragene Strom in der EU sind im Folgenden aufgeführt:  2.400 MHz – 2483,5 MHz: 19,97 dBm (EIRP)  5.150 MHz – 5.250 MHz: 22,96 dBm (EIRP)  5.250 MHz – 5.350 MHz: 22,85 dBm (EIRP)  5.470 MHz – 5.725 MHz: 29,99 dBm (EIRP)  5.150 bis 5.350 MHz sind auf Innenräume beschränkt.</p> <p>Diese Ausrüstung entspricht den EU-Strahlenkontaktgrenzwerten, die für eine unkontrollierte Umgebung definiert wurden. Diese Ausrüstung muss mit einem Mindestabstand von 20 cm zwischen dem Strahlengerät und Ihrem Körper installiert und betrieben werden.</p>
<p><b>Greek</b></p>	<p>Δήλωση Συμμόρφωσης με την Οδηγία για τον Ραδιοεξοπλισμό 2014/53/ΕΕ</p> <p>Με το παρόν η Synology Inc. δηλώνει ότι ο παρών Ασύρματος Δρομολογητής συμμορφώνεται με τις ουσιαστικές απαιτήσεις και τις λοιπές σχετικές διατάξεις της Οδηγίας 2014/53/ΕΕ.</p> <p>Το πλήρες κείμενο της δήλωσης συμμόρφωσης για την ΕΕ είναι διαθέσιμο στην ακόλουθη διεύθυνση Internet:  <a href="https://www.synology.com/support/download/RT2600ac">https://www.synology.com/support/download/RT2600ac</a></p> <p>Όλες οι καταστάσεις λειτουργίας:  2,4GHz: 802.11b, 802.11g, 802.11n (HT20), 802.11n (HT40)  5GHz: 802.11a, 802.11ac (VHT20), 802.11ac (VHT40), 802.11ac (VHT80)</p> <p>Η συχνότητα, η κατάσταση λειτουργίας και η μέγιστη ισχύς μετάδοσης στην ΕΕ αναφέρονται παρακάτω:  2400 MHz – 2483,5 MHz: 19,97 dBm (EIRP)  5150 MHz – 5250 MHz: 22,96 dBm (EIRP)  5250 MHz – 5350 MHz: 22,85 dBm (EIRP)  5470 MHz – 5725 MHz: 29,99 dBm (EIRP)  Η ζώνη 5150 έως 5350 MHz επιτρέπεται μόνο σε εσωτερικούς χώρους.</p> <p>Ο παρών εξοπλισμός συμμορφώνεται με τα καθορισμένα όρια έκθεσης σε ακτινοβολία της ΕΕ για μη ελεγχόμενο περιβάλλον. Ο παρών εξοπλισμός πρέπει να εγκαθίσταται και να λειτουργεί σε ελάχιστη απόσταση 20 εκ. μεταξύ της πηγής ακτινοβολίας και του σώματός σας.</p>

<p><b>Finnish</b></p>	<p>Yhdenmukaisuusjulistus Radiolaitedirektiivin 2014/53/EC mukaan</p> <p>Täten Synology Inc. vakuuttaa, että tämä tuote on yhdenmukainen EU-direktiiviin 2014/53/EC keskeisten vaatimusten sekä sen muiden merkityksellisten määräysten kanssa.</p> <p>Tämän EU-yhdenmukaisuusjulistuksen koko teksti löytyy seuraavasta Internet-osoitteesta: <a href="https://www.synology.com/support/download/RT2600ac">https://www.synology.com/support/download/RT2600ac</a></p> <p>Kaikki käyttötilat:  2,4 GHz: 802.11b, 802.11g, 802.11n (HT20), 802.11n (HT40)  5 GHz: 802.11a, 802.11ac (VHT20), 802.11ac (VHT40), 802.11ac (VHT80)</p> <p>Taajuus, tila ja maksimi lähetetty teho EU:ssa on lueteltu alla:  2400 MHz - 2483,5 MHz: 19,97 dBm (EIRP)  5150 MHz - 5250 MHz: 22,96 dBm (EIRP)  5250 MHz - 5350 MHz: 22,85 dBm (EIRP)  5470 MHz - 5725 MHz: 29,99 dBm (EIRP)  5150 - 5350 MHz on rajoitettu sisäkäyttöön</p> <p>Tämä laite noudattaa EU-säteilyraja-arvoa, joka on asetettu valvomattomalle ympäristölle. Tämä laite tulisi asentaa ja sitä tulisi käyttää 20 cm minimietäisyydellä kehosi ja radiaattorin välillä.</p>
<p><b>French</b></p>	<p>Déclaration de conformité pour la directive sur les équipements radioélectriques 2014/53/UE</p> <p>Par la présente, Synology Inc. déclare que ce routeur sans fil est conforme aux exigences essentielles et autres dispositions connexes de la directive 2014/53/UE.</p> <p>L'intégralité du texte de la déclaration de conformité UE est disponible à l'adresse Internet suivante :  <a href="https://www.synology.com/support/download/RT2600ac">https://www.synology.com/support/download/RT2600ac</a></p> <p>Tous les modes de fonctionnement :  2,4GHz : 802.11b, 802.11g, 802.11n (HT20), 802.11n (HT40)  5GHz : 802.11a, 802.11ac (VHT20), 802.11ac (VHT40), 802.11ac (VHT80)</p> <p>La fréquence, le mode et la puissance émise maximale en UE sont répertoriés ci-dessous :  2400 MHz – 2483,5 MHz : 19,97 dBm (EIRP)  5150 MHz – 5250 MHz : 22,96 dBm (EIRP)  5250 MHz – 5350 MHz : 22,85 dBm (EIRP)  5470 MHz – 5725 MHz : 29,99 dBm (EIRP)  5150 à 5350 MHz est restreint à une utilisation en intérieur.</p> <p>Cet équipement est conforme aux limites d'exposition aux rayonnements de l'UE indiquées pour un environnement non contrôlé. Cet équipement doit être installé et utilisé avec une distance minimale de 20 cm entre le radiateur et votre corps.</p>

<p><b>Italian</b></p>	<p>Dichiarazione di conformità alla Direttiva RED (Radio Equipment Directive) 2014/53/UE</p> <p>Synology Inc. dichiara che il router wireless soddisfa i requisiti essenziali e le altre disposizioni rilevanti della Direttiva 2014/53/UE.</p> <p>Il testo completo della dichiarazione UE di conformità è disponibile al seguente indirizzo Internet: <a href="https://www.synology.com/support/download/RT2600ac">https://www.synology.com/support/download/RT2600ac</a></p> <p>Tutte le modalità operative:  2.4GHz: 802.11b, 802.11g, 802.11n (HT20), 802.11n (HT40)  5GHz: 802.11a, 802.11ac (VHT20), 802.11ac (VHT40), 802.11ac (VHT80)</p> <p>La frequenza, la modalità e la potenza massima trasmessa in UE sono elencate di seguito:  2400 MHz – 2483.5 MHz: 19.97 dBm (EIRP)  5150 MHz – 5250 MHz: 22.96 dBm (EIRP)  5250 MHz – 5350 MHz: 22.85 dBm (EIRP)  5470 MHz – 5725 MHz: 29.99 dBm (EIRP)  Da 5150 a 5350 MHz limitato ad ambienti interni.</p> <p>Quest'apparecchiatura è conforme ai limiti di esposizione alle radiazioni definiti dall'UE per ambienti non controllati. Quest'apparecchiatura deve essere installata e messa in funzione con una distanza minima di 20 cm tra il radiatore e l'utente.</p>
<p><b>Dutch</b></p>	<p>Conformiteitsverklaring voor richtlijn radioapparatuur 2014/53/EU</p> <p>Synology Inc. verklaart hierbij dat deze draadloze router aan de essentiële vereisten en andere relevante bepalingen van richtlijn 2014/53/EU voldoet.</p> <p>De volledige tekst van de EU-conformiteitsverklaring is beschikbaar op het volgende internetadres:  <a href="https://www.synology.com/support/download/RT2600ac">https://www.synology.com/support/download/RT2600ac</a></p> <p>Alle operationele modi:  2.4GHz: 802.11b, 802.11g, 802.11n (HT20), 802.11n (HT40)  5GHz: 802.11a, 802.11ac (VHT20), 802.11ac (VHT40), 802.11ac (VHT80)</p> <p>De frequentie, modus en maximaal verzendingsvermogen in EU is als volgt:  2400 MHz – 2483.5 MHz: 19,97 dBm (EIRP)  5150 MHz – 5250 MHz: 22,96 dBm (EIRP)  5250 MHz – 5350 MHz: 22,85 dBm (EIRP)  5470 MHz – 5725 MHz: 29,99 dBm (EIRP)  5150 tot 5350 MHz is beperkt voor binnengebruik.</p> <p>Dit apparaat voldoet aan de EU-limieten voor stralingsblootstelling bepaald voor ongecontroleerde omgeving. Dit apparaat moet worden geïnstalleerd en gebruikt op een minimale afstand van 20 cm tussen de zender en uw lichaam.</p>

<p><b>Portuguese</b></p>	<p>Declaração de conformidade para a Diretiva 2014/53/UE relativa aos equipamentos de rádio</p> <p>Por este meio, a Synology Inc. declara que o Router Sem Fios está em conformidade com os requisitos essenciais e outras disposições relevantes da Diretiva 2014/53/UE.</p> <p>O texto integral da declaração de conformidade da UE está disponível no seguinte endereço de Internet:  <a href="https://www.synology.com/support/download/RT2600ac">https://www.synology.com/support/download/RT2600ac</a></p> <p>Todos os modos de funcionamento:  2,4 GHz: 802.11b, 802.11g, 802.11n (HT20), 802.11n (HT40)  5 GHz: 802.11a, 802.11ac (VHT20), 802.11ac (VHT40), 802.11ac (VHT80)</p> <p>A frequência, o modo e a potência máxima transmitida na União Europeia estão listados abaixo:  2400 MHz – 2483,5 MHz: 19,97 dBm (EIRP)  5150 MHz – 5250 MHz: 22,96 dBm (EIRP)  5250 MHz – 5350 MHz: 22,85 dBm (EIRP)  5470 MHz – 5725 MHz: 29,99 dBm (EIRP)  5150 a 5350 MHz está restrito a ambientes fechados.</p> <p>Este equipamento está em conformidade com os limites de exposição à radiação da UE definidos para um ambiente não controlado. Este equipamento deve ser instalado e utilizado com uma distância mínima de 20 cm entre o radiador e o seu corpo.</p>
<p><b>Spanish</b></p>	<p>Declaración de conformidad de la Directiva de equipos de radio 2014/53/UE</p> <p>Por la presente, Synology Inc. declara que este enrutador inalámbrico cumple los requisitos esenciales y el resto de disposiciones aplicables de la Directiva 2014/53/UE.</p> <p>El texto completo de la declaración de conformidad de la UE está disponible en la siguiente dirección de Internet:  <a href="https://www.synology.com/support/download/RT2600ac">https://www.synology.com/support/download/RT2600ac</a></p> <p>Todos los modos de funcionamiento:  2,4 GHz: 802.11b, 802.11g, 802.11n (HT20), 802.11n (HT40)  5 GHz: 802.11a, 802.11ac (VHT20), 802.11ac (VHT40), 802.11ac (VHT80)</p> <p>A continuación se enumeran la frecuencia, el modo y la energía transmitida máxima en la UE:  2400 MHz – 2483,5 MHz: 19,97 dBm (EIRP)  5150 MHz – 5250 MHz: 22,96 dBm (EIRP)  5250 MHz – 5350 MHz: 22,85 dBm (EIRP)  5470 MHz – 5725 MHz: 29,99 dBm (EIRP)  El intervalo de 5150 a 5350 MHz está limitado a espacios interiores.</p> <p>Este equipo cumple las limitaciones de exposición a radiación de la UE establecidas para un entorno no controlado. Este equipo se debe instalar y utilizar con una distancia mínima de 20 cm entre el radiador y el cuerpo.</p>

<b>Swedish</b>	<p>Försäkran om överensstämmelse med direktivet för radioutrustning 2014/53/EG</p> <p>Synology Inc. Försäkrar härmed att den här trådlösa routern överensstämmer med de grundläggande kraven och andra gällande bestämmelser för direktivet 2014/53/EG.</p> <p>Den fullständiga texten för EG-försäkran om överensstämmelse finns tillgänglig på följande internetadress: <a href="https://www.synology.com/support/download/RT2600ac">https://www.synology.com/support/download/RT2600ac</a></p> <p>Alla driftslägen: 2,4GHz: 802.11b, 802.11g, 802.11n (HT20), 802.11n (HT40) 5GHz: 802.11a, 802.11ac (VHT20), 802.11ac (VHT40), 802.11ac (VHT80)</p> <p>Frekvensen, läget och den maximalt utsända effekten i EG finns uppräknat här nedanför: 2400 MHz – 2483,5 MHz: 19,97 dBm (EIRP) 5150 MHz – 5250 MHz: 22,96 dBm (EIRP) 5250 MHz – 5350 MHz: 22,85 dBm (EIRP) 5470 MHz – 5725 MHz: 29,99 dBm (EIRP) 5150 till 5350 MHz är begränsat till inomhus.</p> <p>Den här utrustningen överensstämmer med EG-gränser för strålningsexponering i en okontrollerad miljö. Den här utrustningen ska installeras och användas med som minst ett avstånd på 20cm mellan kylaren och din kropp.</p>
----------------	--