



Content

1.0 Operation Elements And Connectors

2.0 References

3.0 Safety References

4.0 Testing

4.1 Purpose of the EVSE Active Test Lead accessory

4.2 Test procedure

4.3 Proximity Pilot (PP) State (Cable Simulation)

4.4 Control Pilot (CP) State (Vehicle Simulation)

4.5 CP Signal output terminals

4.6 CP Error "E" simulation

4.7 Measuring terminals

5.0 Cleaning

6.0 Specifications



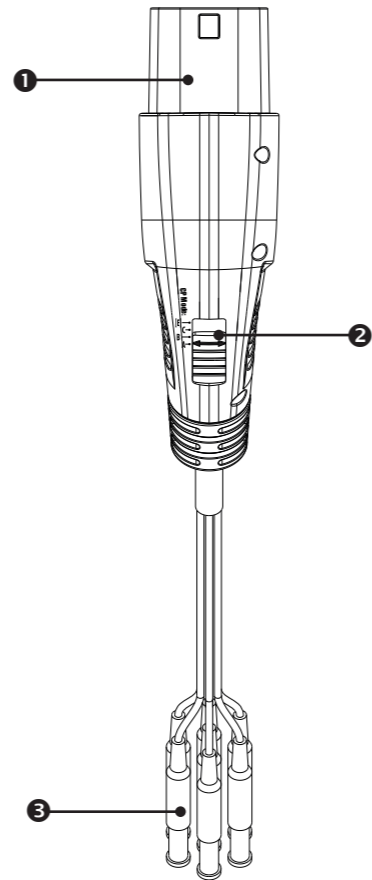

1. Operation Elements And Connectors





1. Type-2 plug
2. Slider switch for CP Mode selection
3. Test leads with 4mm safety plugs for L1, L2, L3, N, PE, CP and PP

Adapter is equipped with 0,5m test leads.



2.0 References marked on instrument or in instruction manual

-  Warning of a potential danger, follow with instruction manual.
-  Reference! Please use utmost attention.
-  Caution! Dangerous voltage. Danger of electrical shock.
-  Ground terminal
-  Continuous double or reinforced insulation category II IEC 536/DIN EN 61140.

 Conformity symbol, the instrument complies with the valid directives. It complies with the EMC Directive (2014/30/EU), Standard EN 61326 is fulfilled. It also complies with the Low Voltage Directive (2014/35/EU) Standards EN 61010-1 and EN 61010-031.

 Instrument fulfils the standard (2012/19/EU) WEEE. This marking indicates that this product should not be disposed with other household wastes throughout the EU. To prevent possible harm to the environment or human health from uncontrolled waste disposal, recycle it responsibly to promote the sustainable reuse of material resources. To return your used device, please use the return and collection systems or contact the retailer where the product was purchased. They can take this product for environmental safe recycling.

3.0 Safety references

-  The respective accident prevention regulations established by the professional associations for electrical systems and equipment must be strictly met at all times.
-  In order to avoid electrical shock, the valid safety and VDE regulations regarding excessive contact voltages must receive utmost attention, when working with voltages exceeding 120V (60V) DC or 50V (25V) rms AC. The values in brackets are valid for limited ranges (as for example medicine and agriculture).
-  Measurements in dangerous proximity of electrical systems are only to be carried out in compliance with the instructions of a responsible electronics technician, and never alone.

 If the operator's safety is no longer ensured, the instrument is to be put out of service and protected against use. The safety is no longer insured, if the instrument:

- shows obvious damage
- does not carry out the desired measurements
- has been stored for too long under unfavourable conditions
- has been subjected to mechanical stress during transport.

 The instrument may only be used within the operating ranges as specified in the technical data section.

 Avoid any heating up of the instrument by direct sunlight to ensure perfect functioning and long instrument life.

 The opening of the instrument for fuse replacement, for example, may only be carried out by professionals. Prior to opening, the instrument has to be switched off and disconnected from any current circuit.

 The instrument may only be used under those conditions and for those purposes for which it was conceived. For this reason, in particular the safety references, the technical data including environmental conditions and the usage in dry environments must be followed.

When modifying or changing the instrument, the operational safety is no longer ensured.

4.0 Testing

4.1 Purpose of the EVSE Active Test Lead accessory

The HDT EVSE Active Test Lead is an accessory to support all relevant measurements of a Multifunction Tester (MFT) to simply wire between the EVSE charging point (Type-2 connector) and the measurement inputs of the MFT. All wires of the charging connector are available: L1, L2, L3, N, PE, CP and PP. This allows to perform typical MFT measurements: Voltage, frequency, phase indication, phase sequence, various RCD tests and measurements, insulation resistance, low ohm measurements, line and loop impedances,

4.2 Test procedure:

Connect the needed 4mm test plugs of the HDT EVSE Active Test Lead to your MFT.

- Select CP Mode "A" with the slider switch.
- Connect HDT EVSE Active Test Lead to the Type-2 connector of the charging point.
- Select CP Mode "B" with the slider switch, the charging point should show "ready to charge".
- Select CP Mode "C" with the slider switch, the charging point starts charging.
- Perform all measurements in active stage of the charging point (voltage and similar).
- After you completed all your measurements select CP Mode "A" with the slider switch to stop charging.
- Unplug HDT EVSE Active Test Lead from the charging point.

4.3 Proximity Pilot (PP) State (Cable Simulation)

The HDT EVSE Active Test Lead is configured internally (680 Ohm between PP and PE) to setup 20 A current capability.

4.4 Control Pilot (CP) State (Vehicle Simulation)

With the CP Mode slider switch various vehicle states can be simulated. Vehicle states are simulated with different resistances connected between CP and PE conductors. Correlation between resistance and vehicle states is shown in Table below.

Vehicle State	State Description	CP-PE Resistance	CP terminal voltage
A	Electric vehicle not connected	Open (∞)	$\pm 12V$ @ 1KHz
B	Vehicle connected, not ready to charge	2.74K	+9V/-12V @ 1KHz
C	Electric vehicle connected ready to charge, ventilation not required	882 Ω	+6V/-12V @ 1KHz
[E]	CP Error „E“ (see below)	0 Ω	0V

4.5 CP Signal output terminals

CP output terminals are short connected to the CP and PE conductors of the tested charging station via the test cable. Use an oscilloscope to check the waveform and amplitude of the CP signal. Control Pilot function uses Pulse Width Modulation (PWM) to code communication between a vehicle and charging station. The duty cycle of the PWM signal defines the possible available charging current, while amplitude defines charger state. For details of communication protocol please refer to IEC/EN 61851-1 and the documentation of the manufacturer of the charging station.

Important note: In the case of wrong wiring of the charging station, low signal CP test terminals can get high, live hazard voltage.

4.6 CP Error "E" simulation

"E" - CP Error simulation could be realized by pushing the slider switch into (spring loaded) position [E]. This will simulate behaviour of the station when there is a short circuit between CP and PE through internal diode (acc. to standard IEC/EN 61851-1). In the case of CP Error ("E" is pushed), result should be aborting of the charging process and new charging process is prevented.

4.7 Measuring terminals

Measuring terminals (no. 1 and 2 on the picture) are directly connected to L1, L2, L3, N and PE conductors of the tested charging station. It is allowed to use these for measuring purposes only. It is not allowed to draw current over a longer period or supply anything else. An appropriate measurement instrument is needed.

5.0 Cleaning

If the instrument is dirty after daily usage, it is advised to clean it by using a humid cloth and a mild household detergent. Prior to cleaning, ensure that instrument is switched off and disconnected from external voltage supply and any other instruments connected (such as UUT, control instruments, etc.). Never use acid detergents or dissolvent for cleaning.

6.0 Specifications

- Input voltage: 230/400 V 3~ 50/60 Hz
- Measurement Category: CAT II 300V
- Mains socket rating: max. 10A
- PP simulation: setup internally to 20 A
- CP simulation: States A, B, C
- Error simulation: CP error "E"
- Test connector type: IEC 62196-2 Type 2 male
- Test cable length: 0,5 m
- Working temperature: 0 ... +40°C
- Storage temperature: -10 ... +50°C
- Humidity: 0-80% RH
- Compliance to: IEC 61010-1/ IEC 61010-031

Warranty

Triplett Test Equipment and Tools extends the following warranty to the original purchaser of these goods for use. Triplett warrants to the original purchaser for use that the products sold by it will be free from defects in workmanship and material for a period of (1) one year from the date of purchase. This warranty does not apply to any of our products which have been repaired or altered by unauthorized persons in any way or purchased from unauthorized distributors so as, in our sole judgment, to injure their stability or reliability, or which have been subject to misuse, abuse, misapplication, negligence, accident or which have had the serial numbers altered, defaced, or removed. Accessories, including batteries are not covered by this warranty

Copyright © 2024 Triplett
www.triplett.com