



## OWNER'S MANUAL

# WASHING MACHINE

---



Before beginning installation, read these instructions carefully. This will simplify installation and ensure that the product is installed correctly and safely. Leave these instructions near the product after installation for future reference.

**EN ENGLISH**

WTP357B



MFL69482536  
Rev.00\_122120

[www.lg.com](http://www.lg.com)

Copyright © 2020 LG Electronics Inc. All Rights Reserved

# TABLE OF CONTENTS

This manual may contain images or content different from the model you purchased.

This manual is subject to revision by the manufacturer.

<b>SAFETY INSTRUCTIONS .....</b>	<b>3</b>
<b>IMPORTANT SAFETY INSTRUCTIONS .....</b>	<b>3</b>
<b>INSTALLATION .....</b>	<b>9</b>
Parts .....	9
Accessories .....	9
Specifications .....	10
Installation Place Requirements .....	11
Unpacking and Removing Packing Materials .....	12
Stacking Mini Washer .....	12
Connecting the Supply Hose .....	13
Installing the Drain Hose .....	16
Leveling the Appliance .....	17
<b>OPERATION .....</b>	<b>18</b>
Using the Appliance .....	18
Sorting Laundry .....	19
Closing the Door and Drawer .....	20
Adding Cleaning Products .....	21
Control Panel .....	23
Programme Table .....	24
Option Programme .....	26
<b>SMART FUNCTIONS .....</b>	<b>27</b>
LG ThinQ Application .....	27
Smart Diagnosis .....	27
<b>MAINTENANCE .....</b>	<b>28</b>
Cleaning Your Washing Machine .....	28
Tub Clean .....	29
Cleaning the Water Inlet Filter .....	29
Cleaning the Lint Filter .....	30
Care in Cold Climates .....	30
<b>TROUBLESHOOTING .....</b>	<b>32</b>
Diagnosing Problems .....	32
Error Messages .....	37

The following safety guidelines are intended to prevent unforeseen risks or damage from unsafe or incorrect operation of the appliance.

The guidelines are separated into 'WARNING' and 'CAUTION' as described below.

 This symbol is displayed to indicate matters and operations that can cause risk. Read the part with this symbol carefully and follow the instructions in order to avoid risk.

 **WARNING**

This indicates that the failure to follow the instructions can cause serious injury or death.

 **CAUTION**

This indicates that the failure to follow the instructions can cause the minor injury or damage to the product.

## IMPORTANT SAFETY INSTRUCTIONS

 **WARNING**

To reduce the risk of explosion, fire, death, electric shock, injury or scalding to persons when using this product, follow basic precautions, including the following:

## Technical Safety

- This appliance is not intended for use by persons (including children) with reduced physical, sensory or mental capabilities, or lack of experience and knowledge, unless they have been given supervision or instruction concerning use of the appliance by a person responsible for their safety.
- Children should be supervised to ensure that they do not play with the appliance.
- If the power cord is damaged, it must be replaced by the manufacturer, its service agent or similarly qualified persons in order to avoid a hazard.
- Use a new hose or hose-set supplied with the appliance. Reusing old hoses can cause a water leak and subsequent property damage.
- Ventilation openings must not be obstructed by a carpet.
- This appliance is intended to be used in household only and not in applications such as:
  - Staff kitchen areas in shops, offices and other working environments;
  - Farm houses;
  - By clients in hotels, motels and other residential type environments;
  - Bed and breakfast type environments;
  - Areas for communal use in blocks of flats or in launderettes
- The inlet water pressure must be between 0.1 and 0.8 MPa.
- The maximum capacity in some cycles for dry clothes to be washed is 3.5 kg.

## Installation

- Never attempt to operate the appliance if it is damaged, malfunctioning, partially disassembled, or has missing or broken parts, including a damaged cord or plug.
- This appliance should only be transported by two or more people holding the appliance securely.
- Do not install the appliance in a damp and dusty place. Do not install or store the appliance in any outdoor area, or any area that is subject to weathering conditions such as direct sunlight, wind, or rain or temperatures below freezing.
- Tighten the drain hose at connecting ends to avoid separation.
- If the power cord is damaged or the hole of the socket outlet is loose, do not use the power cord and contact an authorized service centre.
- This appliance must not be installed behind a lockable door, a sliding door or a door with a hinge on the opposite side to that of the appliance, in such a way that a full opening of the appliance door is restricted.
- This appliance must be grounded (earthed via the power cord). In the event of malfunction or breakdown, grounding will reduce the risk of electric shock by providing a path of least resistance for electric current.
- This appliance is equipped with a power cord having an equipment-grounding conductor (earthing pin) and a grounding power plug. The power plug must be plugged into an appropriate socket outlet that is installed and grounded in accordance with all local codes and ordinances.
- Improper connection of the equipment-grounding conductor can result in risk of electric shock. Check with a qualified electrician or service personnel if you are in doubt as to whether the appliance is properly grounded.
- Do not modify the power plug provided with the appliance. If it does not fit the outlet, have a proper outlet installed by a qualified electrician.

## Operation

- Mini washer suitable for cold wash operation only.
- Do not use a sharp object like drill or pin to penetrate, modify or disassemble the unit.
- Do not repair or replace any part of the appliance. All repairs and servicing must be performed by qualified service personnel unless specifically recommended in this Owner's Manual. Use only authorized factory parts.
- Do not reach into the appliance if the tub or agitator is moving.
- Keep the area underneath and around the appliance free of combustible materials such as lint, paper, rags, chemicals, etc.
- Do not put animals, such as pets into the appliance.
- Do not leave the appliance door open. Children may hang on the door or crawl inside the appliance, causing damage or injury.
- Never reach into the appliance while it is operating. Wait until the drum has completely stopped.
- Do not put in, wash or dry articles that have been cleaned in, washed in, soaked in, or spotted with combustible or explosive substances (such as wax, oil, paint, gasoline, degreasers, drycleaning solvents, kerosene, vegetable oil, cooking oil, etc.). Improper use can cause a fire or explosion.
- In case of flood, disconnect the power plug and contact the LG Electronics customer information centre.
- Do not push down the drawer excessively, when the appliance drawer is open.

- Do not use flammable gas and combustible substances (benzene, gasoline, thinner, petroleum, alcohol, etc.) near the appliance.
- If the drain hose or inlet hose is frozen during winter, use it only after thawing.
- Keep all washing detergents, softener and bleach away from children.
- Do not touch the power plug or the appliance controls with wet hands.
- When pulling out the power plug from an outlet, hold the power plug, not the cable.
- Do not bend the power cable excessively or place a heavy object on it.
- If there is a gas leakage (isobutane, propane, natural gas, etc.), do not touch the appliance or power plug and ventilate the area immediately.
- Do not install the Mini Washer on top of another Mini Washer or Pedestal or elevated surface or stand.
- To avoid breaking the door glass, do not push too hard on the door when closing.
- Do not step on Mini Washer.
- Do not wash rugs, mats, shoes or pet blankets, or any other items other than clothes or small sheets, in this machine.
- This appliance must only be used for domestic household purposes and should not be used in mobile applications.
- Do not open or close the door by foot.

## Maintenance

- Do not spray water inside or outside the appliance to clean it.
- Disconnect the power cord before cleaning the appliance.
- Never unplug the appliance by pulling on the power cable. Always grip the power plug firmly and pull straight out from the socket outlet.
- Securely plug the power plug in the socket outlet after completely removing any moisture and dust.

## Disposal

- Before discarding an old appliance, unplug it. Cut off the cable directly behind the appliance to prevent misuse.
- Dispose of all packaging materials (such as plastic bags and styrofoam) away from children. The packaging materials can cause suffocation.
- Remove the door before disposing of or discarding this appliance to avoid the danger of children or small animals getting trapped inside.

## Parts

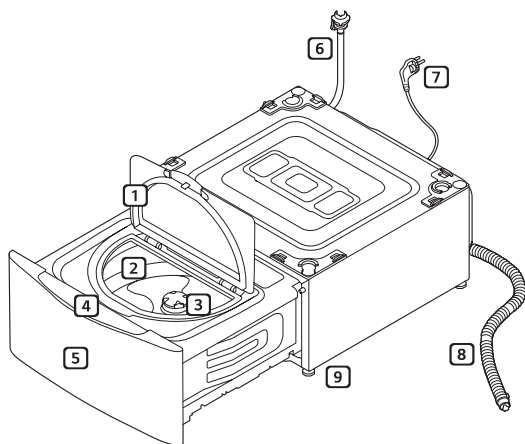

- 1 Door/Lid
- 2 Drum
- 3 Lint Filter
- 4 Control Panel
- 5 Drawer
- 6 Water Supply Hose
- 7 Power Plug
- 8 Water Drain Hose
- 9 Leveling Feet

## Accessories

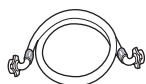

Water supply hose  
(for cold water)



Connecting  
supply hose



Water drain hose

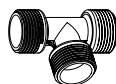

Water supply hose  
connector



Water drain hose  
connector



Cable ties



Anti-slip sheets



Spanner



Detergent  
measuring  
cup



Screws  
(18EA) / (5EA)



Band clamps  
(3 EA)

• Different accessories may apply to each model.

## Specifications

Maximum Wash Load	3.5 kg
Power Supply	220 - 240 V~, 50 Hz
Size	700 mm (W) x 770 mm (D) x 360 mm (H)
Product Weight	48.7 kg
Permissible Water Pressure	0.1 - 0.8 MPa (1.0 - 8.0 kgf / cm <sup>2</sup> )

- Appearance and specifications may change without notice to improve the quality of the product.
- No further backflow protection required for connection to the water supply.

## Installation Place Requirements

### Location

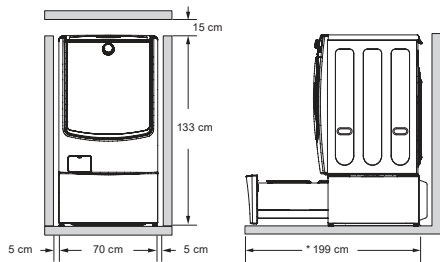

\* 199 cm : additionally needed for service.

**Level floor** : Allowable slope under the entire appliance is 1°.

**Power outlet** : Must be within 1.5 meters of either side of the location of the appliance.

**Additional Clearance** : 5 cm at the sides and 10 cm behind the unit.

- These products may damage the finish or controls.

### ⚠ WARNING

- The plug must be plugged into an appropriate outlet that is properly installed and grounded in accordance with all local codes and ordinances.

### Positioning

- Install the appliance on a flat hard floor. Do not install on an elevated surface.
- Make sure that air circulation around the appliance is not impeded by carpets, rugs, etc.
- Never try to correct any unevenness in the floor with pieces of wood, cardboard or similar materials under the appliance.

- Do not install the appliance in rooms where freezing temperatures may occur. Frozen hoses may burst under pressure. The reliability of the electronic control unit may be impaired at temperatures below freezing point.
- Ensure that when the appliance is installed, it is easily accessible for an engineer in the event of a breakdown.
- With the appliance installed, adjust all four feet using a transit bolt spanner to ensure the appliance is stable, and a clearance of approximately 15 cm is left between the top of the appliance and the underside of any work-top.
- If the appliance is delivered in winter and temperatures are below freezing, place the appliance at room temperature for a few hours before putting it into operation.
- Do not use a drip pan as it can block the drawer. Using the drip pan may result in increased vibration and noise during operation.

### ⚠ WARNING

- This equipment is not designed for maritime use or for use in mobile installations such as caravans, aircraft etc.
- DO NOT Stack, store, or place any items or appliances on top of the Main Washer.

### Electrical Connection

- Do not use an extension cord or double adapter.
- Always unplug the appliance and turn off the water supply after use.
- Connect the appliance to an earthed socket in accordance with current wiring regulations.
- The appliance must be positioned so that the plug is easily accessible.
- Repairs to the appliance must only be carried out by qualified personnel. Repairs carried out by inexperienced persons may cause injury or serious malfunctioning. Contact your local service centre.

## Unpacking and Removing Packing Materials

- 1 Lift the appliance off the foam base.
  - If you must lay the appliance down to remove the carton base, always protect the side of the appliance and lay it carefully on its side. Do not lay the appliance on its front or back.
- 2 Pull and save the foam block for future use.
  - If the washing machine must be moved in the future, the foam block will help prevent damage to the washing machine during transportation.

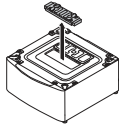

### NOTE

- To prevent damage, do not remove the foam block until the washing machine is ready for assembly with the Main washer.
- 3 Rotate the top cover 180 degrees.
    - Cover the upper hole with the top cover and install 4 short screws (included in packing box) to fix it in place.

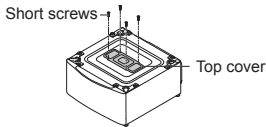

### **!** WARNING

- The plastic top cover must be secured to avoid the risk of electric shock or short circuit from water drops. Failure to do so can cause serious injury, fire, electric shock or death.

## Stacking Mini Washer

- 1 Make sure the leveling feet on the Main front-loading washing machine are fully wound in before stacking. Place the Main front-loading washing machine on top of the Mini Washer. Make sure the legs of the Main top of this Mini Washer align with the holes in the front-loading washing machine.

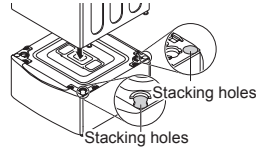

- 2 Install 4 long screws (included in box) on each side to securely attach the front-loading washing machine to the Mini Washer.

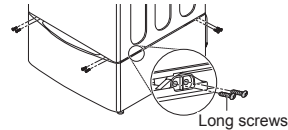

- 3 Adjust the feet of top main front-loading washing machine slightly until they gently seat up against the Mini Washer. Extend all the legs 1/2 turn with wrench and tighten all 4 lock nuts. All lock nuts must be tightened.

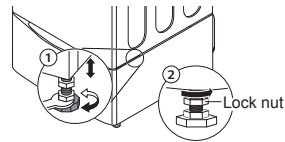

## **⚠ WARNING**

- This Mini Washer must be installed underneath the matching LG front-loading washing machine only. It must not be used as a stand alone (bench top)washer.
- This Mini Washer will not work as a standalone unit.
- This Mini Washer can only be used and operated when stacked under the matching LG front loading washing machine.

## **Connecting the Supply Hose**

- Water supply pressure must be between 0.1 MPa and 0.8 MPa (100 ~ 800 kPa).
- Do not strip or crossthread when connecting supply hose to the valve. Do not use any mechanical devise to tighten the hose connector to the machine or to the supplied connector / adaptor.
- If the water supply pressure is more than 0.8 MPa, a water pressure limiting device should be installed.
- Periodically check the condition of the hose and replace the hose if necessary. Do not used old hoses.

## **Checking the Rubber Seal on the Supply Hose**

Two rubber seals are supplied with the water supply necessary. Do not used old hoses. They are used for preventing water leaks. Make sure the connection to taps is sufficiently tight but not overtightened.

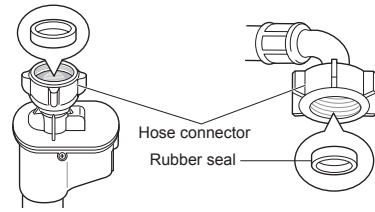
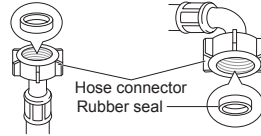

## Connecting Hose to Water Tap

### Connecting Screw-Type Hose to Tap with Thread

Screw the hose connector onto the cold water supply tap. Do not overtighten or use any mechanical grips to tighten the hoses.

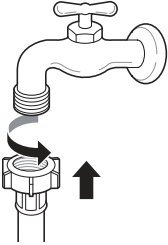

### Connecting Screw-Type Hose to Tap without Thread

- 1 Loosen the four fixing screws.

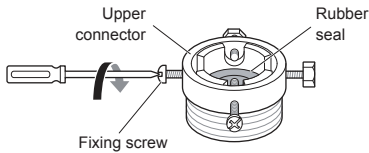

- 2 Remove the guide plate if the tap is too large to fit the adapter.

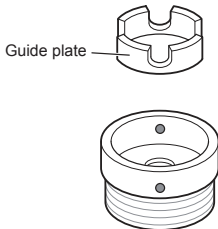

- 3 Push the adapter onto the end of the tap so that the rubber seal forms a watertight connection. Tighten the four fixing screws.

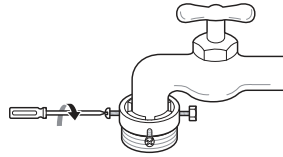

- 4 Push the supply hose vertically upwards so that the rubber seal within the hose can adhere completely to the tap and then tighten it by screwing it to the right.

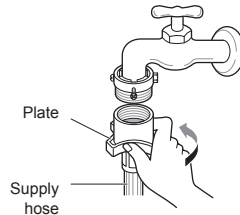

### Connecting One Touch Type Hose to Tap Without Thread

- 1 Unscrew the adapter ring plate and loose the four fixing screws.

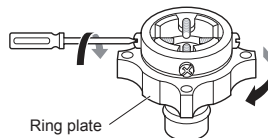

- 2** Remove the guide plate if the tap is too large to fit the adapter.

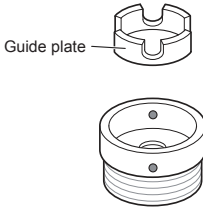

- 3** Push the adapter onto the end of the tap so that the rubber seal forms a watertight connection. Tighten the four fixing screws and the adapter ring plate.

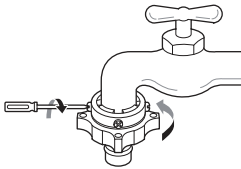

- 4** Pull the connector latch plate down, push the supply hose onto the adapter, and release the connector latch plate. Make sure the adapter locks into place.

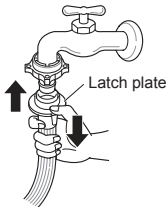

## NOTE

- After connecting the supply hose to the water tap, turn on the water tap to flush out foreign substances (dirt, sand, sawdust, and etc.) in the water lines. Let the water drain into a bucket, and check the water temperature.

## Connecting the Cold inlet hoses to both Washing Machines

- 1** Connect the water supply hose connector to the water supply hose of the Main front-loading washing machine. Open the accessory installation package of this Mini Washer to find the Connector/Adaptor and the short connection hose.

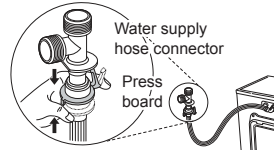

- 2** Connect the the normal length supply hose of Mini Washer to one end of the water supply hose connector.

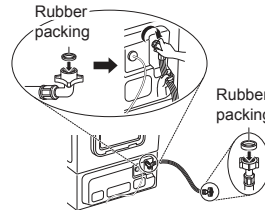

- 3** Connect the additionally provided water supply hose of the Main front-loading washing machine to another side of the plastic water supply hose connector and then finally connect one side of the Short Inlet hose (supplied in the accessory package of the Mini Washer) to the plastic 3 way connector and the other end to the Cold water tap.

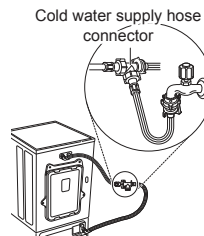

## Installing the Drain Hose

- The drain hose should not be placed higher than 100 cm above the floor. Water in the appliance may not drain or may drain slowly.
- 1 Insert the band clamp onto the drain hose elbow. Pliers may be required to open the clamp so it can be fitted to the rubber end of the hose.

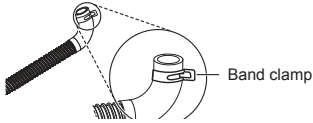

- 2 With the hose leading up from the elbow, firmly insert the elbow onto the drain outlet on the back of Mini Washer.

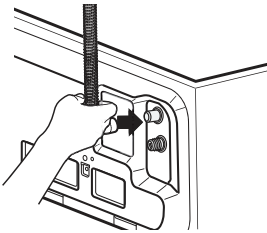

- 3 Adjust the band clamp with pliers to keep the hose securely in place to prevent leaking.

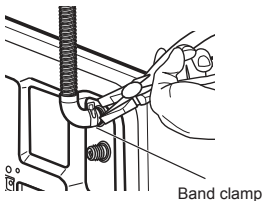

## Using the Drain Hose Connector

- 1 Connect the drain hose of the front-loading washing machine and the Mini Washer to the drain connector.
- 2 Insert the included band clamps on to the ends of the two drain hoses.
- 3 Push the drain hoses firmly onto the drain connector.

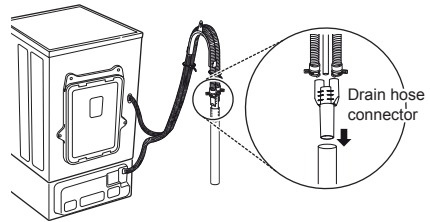

### ⚠ CAUTION

- Adjust the band clamps to prevent the hoses from coming loose or leaking. Failure to do so could result in flooding. Use of the drain connector helps avoid siphoning, odors, or improper draining.

## Leveling the Appliance

If the floor is uneven, turn the adjustable feet of the Mini Washer as required (Do not insert pieces of wood etc. under the feet). Make sure that all four feet are stable and resting on the floor and then check that the appliance is perfectly level (Use a spirit level).

- Once the appliance is level, tighten the lock nuts up towards the base of the appliance. All lock nuts must be tightened.

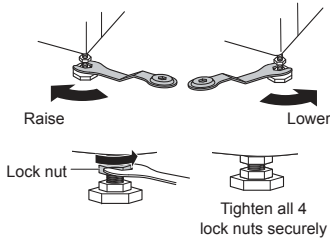

### Diagonal Check

- When pushing down on the edges of the top plate diagonally, the appliance should not move up and down at all (check both directions). If the appliance rocks when pushing the machine top plate diagonally, adjust the necessary foot or feet again.

### ⚠ WARNING

- After stacking Main front-loading washing machine on to the Mini Washer, use the leveling feet on Mini Washer to level both. The main front-loading washing machine's leveling feet should already be firmly snug against the Mini Washer and the locknuts turned counterclockwise to secure them.

### NOTE

- Timber or suspended type flooring will contribute to excessive vibration and unbalance.

## Using Anti-Slip Sheets (some models only)

If you install the appliance on a slippery surface, it may move because of excessive vibration. Incorrect leveling may cause malfunction through noise and vibration. If this occurs, install the anti-slip sheets under the leveling feet and adjust the level.

- 1 Clean the floor to attach the anti-slip sheets.
  - Use a dry rag to remove and clean foreign objects and moisture. If moisture remains, the anti-slip sheets may slip.
- 2 Adjust the level after placing the appliance in the installation area.
- 3 Place the adhesive side of the anti-slip sheets on the floor.
  - It is most effective to install the anti-slip sheets under the front feet. If it is difficult to place the pads under the front feet, place them under the back feet.

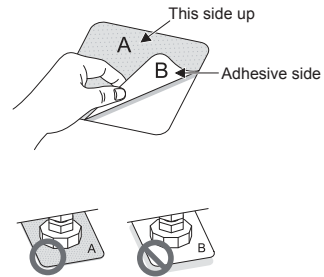

- 4 Ensure the appliance is level.
  - Push or rock the top edges of the appliance gently to make sure that the appliance does not rock. If the appliance rocks, level the appliance again.

### NOTE

- You can obtain anti-slip sheets from an LG Service Centre or a Hardware store.

## Using the Appliance

- Sort laundry and load items.
  - Sort laundry by fabric type, soil level, colour and load size as needed. Open the door and load items into Mini Washer.
  - Heavy and normally soiled laundry is not suitable for this appliance. The maximum wash load must not exceed 3.5 kg.

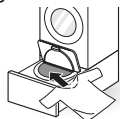

- Add cleaning products.
  - Add the proper amount of detergent with the detergent measuring cup directly to the washing drum evenly. The use of Drum only type (low sudsing) detergent is recommended. Do not add any softening agent.

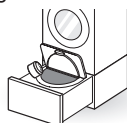

- Close the Lid by pushing it gently until it locks into position.
- Turn on the washing machine.
  - Press the **Power** button to turn on the washing machine.

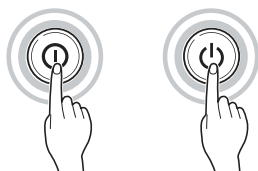

- Choose the desired washing cycle.
  - Press the cycle button repeatedly until the desired cycle is selected.



- Begin cycle.
  - Press the **Start/Pause** button to begin the cycle. The washing machine will agitate briefly without water to measure the weight of the load. If the **Start/Pause** button is not pressed within a certain time, the appliance will shut off and all settings will be lost.



- Add softener.
  - When the machine chimes for about 20 seconds toward the end of the wash, open the Drawer, add the softener and press **Start/Pause** to restart the cycle before closing the drawer again. If no softener is added, the machine will automatically resume washing shortly after the Chime stops..

- End of cycle.
  - When the cycle is finished, another melody will sound. Immediately remove your clothing from the washing machine to reduce wrinkling and odours.
  - After washing is complete, wipe off the washing machine door, gasket and inside the washing drum with soft dry towel for clean washing.

## Sorting Laundry

- 1 Look for the care label on your clothes.
  - This will tell you about the fabric content of your garment and how it should be washed.
  - Symbols on the care labels.



Normal machine wash



Permanent press



Delicate



Hand wash



Do not wash

## 2 Sorting laundry.

- To get the best results, sort clothes into loads that can be washed with the same wash cycle.
- Different fabrics need to be washed on different cycles and spin speeds.
- Always sort dark colours from pale colours and whites. Wash separately as dye and lint transfer can occur causing discolouration of white and pale garments.
- The Mini Washer is not designed to wash normal or heavily soiled items and should be used to wash lightly soiled and special care items only. The maximum load must not exceed 3.5kg.
  - Colour (White, Lights, Darks):  
Separate white fabrics from coloured fabrics.
  - Lint (Lint producers, Collectors):  
Wash lint producers and lint collectors separately.
- Wash lightly soiled and special care load in Mini Washer.

## 3 Caring before loading.

- Do not wash items that contain support or memory wire such as Bras as it may damage other clothes as well as the washing machine and cause noise and vibration.
- Check all pockets to make sure that they are empty. Items such as nails, hair clips, matches, pens, coins and keys can damage both your washing machine and your clothes.
- Close zippers, hooks and strings to make sure that these items don't snag on other clothes.
- Pre-treat dirt and stains by brushing a small amount of detergent dissolved water onto stains to help lift dirt.
- If an item of clothing has a long lace attached to it, arrange the lace so it cannot be tangled or put it into a washing net.

## Closing the Door and Drawer

- 1 Close the washing machine Lid until it clicks.

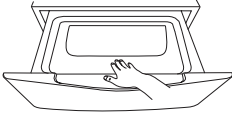





- 2 Push the drawer completely closed.

### ⚠ CAUTION

- Do not let your hands get stuck between the door and the washing machine, as this can cause injury.
- Forcing the drawer or the Lid to open can cause damage to parts, malfunction and safety problems.
- Closing the drawer before having closed the Lid completely may scratch the Lid's glass.
- Ensure the drawer is pulled out completely to prevent the Lid from contacting the Main front load washing machine.

### NOTE

- The Lid lock may fail if there is too much laundry in the machine or if the Lid is not completely closed.
- If the product is operating or the drawer lock  indicator is displayed, the Drawer will not open. To open the door, press the **Start/Pause** button to stop the washer, and when drawer lock  indicator disappears, open the drawer. Do not force the drawer and Lid open.
- If , ,  or a warning sign appears on the display, close the drawer and the Lid completely. After doing so, press the **Start/Pause** button.

- If the drawer cannot be opened completely, pull the drawer forward with a little force using both hands.
- If power failure occurs during product operation, the door cannot be opened. Provide the power again or contact the LG service centre.

## Adding Cleaning Products

### Detergent Dosage

- Detergent should be used according to the instruction of the detergent manufacturer and selected according to type, colour, soiling of the fabric and washing temperature.
- If too much detergent is used, too many suds can occur and this will result in poor washing results or cause heavy load to the motor and induce a malfunction. If the water temperature is too cold, then the detergent will not dissolve and can remain inside the machine causing odors.
- If you wish to use liquid detergent follow the guidelines provided by the detergent manufacturer.
- If too many suds occur, reduce the detergent amount.
- Detergent usage may need to be adjusted for ambient water temperature, water hardness, size and soil level of the load. For best results, avoid oversudsing.
- Refer to the label of the clothes, before choosing the detergent and wash course.
- When using the washing machine, use designated cold water detergent for each type of clothing only:
  - General powdered detergents for all types of fabric
  - Powdered detergents for delicate fabric
  - Liquid detergents for all types of fabric or designated detergents only for wool
- For better washing performance and whitening, use detergent with the general powdered bleach.

## Adding Detergent

Measure the detergent with the detergent dispenser (rubber cup supplied with the washer) pour it into the tub.

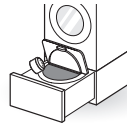

- Use the provided detergent measuring cup to add only one cup of detergent.
- Less detergent is required for lightly soiled items. Please use appropriate amount of detergent in this Mini Washer. If you use too much detergent, excessive bubbles will remain after rinsing.

## Adding Softeners

### Adding Fabric Softener

**CASE 1. When the machine chimes during the wash:**

- 1 Press **Start/Pause** to pause the cycle.
- 2 Slide open the drawer, open the door, and add the liquid fabric softener.
- 3 Close the Lid, slide the drawer closed, and press **Start/Pause** to restart the cycle.

**CASE 2. If you miss the softener add point:**

- 1 Press the **Power** button to interrupt the cycle.
- 2 Slide open the drawer, open the door, and when the washer liquid fabric softener.
- 3 Close the Lid, Slide the drawer, and select the **Rinse+Spin** programme.
- 4 Press the **Start/Pause** to restart the cycle.

### NOTE

- Do not pour fabric softener directly on the clothes.
- The softener can also be diluted with water and added directly into the drum. Do not pour undiluted softener directly onto clothing as it may stain fabrics.

## Adding Water Softener

A water softener, such as anti-limescale can be used to cut down on the use of detergent in areas with high water hardness level.

- Dispense according to the amount specified on the packaging. First add detergent and then the water softener.

### CAUTION

- Do not directly pour bleach on to the clothes. This may cause partial discoloration and severe damage to the load.
- Do not use chlorine bleach or acidic cleaner when washing the laundry, as it can cause damage to clothes such as discoloration of the clothes.

## Control Panel

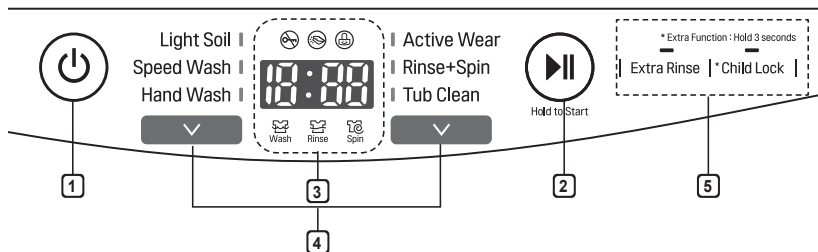

### 1 Power Button

- Press the **Power** button to turn the washing machine on.

### 2 Start/Pause Button

- This **Start/Pause** button is used to start the wash cycle or pause the wash cycle.
- If a temporary stop of the wash cycle is needed, press the **Start/Pause** button.

#### NOTE

- If the **Start/Pause** button is not pressed within a certain time, the appliance will shut off and all settings will be lost.

### 3 Display

- The display shows the cycle status and estimated time remaining.
- : Drawer lock indicator
- : Lid lock indicator
- : Child lock indicator

### 4 Programme Button

- Programmes are available according to laundry type.

### 5 Options

- Use these buttons to select the desired options for the selected programme. All options may not be available in each programme.
- The setting lights above the buttons illuminate to show the current selection.

## Programme Table

### Washing Programme

All programmes are cold water only.

Programme	Description	Note
<b>Light Soil</b>	Use this programme to wash lightly soiled normal items, except delicate fabrics such as wool or silk.	<ul style="list-style-type: none"> <li>Pressing the <b>Start/Pause</b> button without selecting a programme will cause the Light Soil programme to begin immediately using the default settings.</li> </ul>
<b>Speed Wash</b>	Use this programme to speed up the washing time for small loads and lightly soiled clothes.	<ul style="list-style-type: none"> <li>Use very little detergent in this programme.</li> </ul>
<b>Hand Wash</b>	Use this programme to wash textiles, lingerie, or fine clothes likely to shrink or deform.	<ul style="list-style-type: none"> <li>To reduce damage to textiles and improve washing performance, use special neutral detergent for wool.</li> <li>To prevent damage to clothes, the drum spins gently to the left and right for washing.</li> </ul>

Programme	Description	Note
<b>Active Wear</b>	Use this programme to wash performance garments that are specially designed and treated for sports.	<ul style="list-style-type: none"> <li>• Use quantity of detergent that is appropriate for load size.</li> <li>• Do not wash white or brightly colored laundry with darkly colored laundry that can discharge colors and contaminate clothes.</li> <li>• Washing can remove stains more effectively.</li> <li>• It is more effective to pre-wash laundry which is stained with blood or milk briefly before carrying out main washing can remove stains more effectively.</li> <li>• Suds Removing Function: If an excessive amount of detergent is used, the Suds removing function may operate.</li> </ul>
<b>Rinse+Spin</b>	Select this programme to rinse and spin a load separately from a regular cycle.	<ul style="list-style-type: none"> <li>• Add fabric softener only.</li> </ul>
<b>Tub Clean</b>	Use this function to keep the drum clean by sterilizing germs within the drum.	<ul style="list-style-type: none"> <li>• Never load laundry while using Tub Clean. The laundry may be damaged or contaminated with cleaning products. Make sure to run the Tub Clean programme only when the drum is empty.</li> <li>• Leave the lid open after finishing the laundry to dry our the drum.</li> <li>• Tub Clean should be repeated monthly.</li> </ul>

## Option Programme.

### Extra Rinse

Use this option to increase the number of rinsing programmes.

- 1 Press the **Power** button.
- 2 Select a washing programme.
- 3 Press the **Extra Rinse** button to set the additional rinses required.
  - When you press the **Extra Rinse** button, the number of rinsing cycles up to 5 depending on the cycle to be added will be displayed.
- 4 Press the **Start/Pause** button.

### Spin Only

- 1 Open the Lid and evenly load the clothes and then close the Lid. Then press the **Power** button.
- 2 Select the **Rinse+Spin** Programme.
- 3 Press the **Extra Rinse** button 5 times (so that only the Spin Indicator is lit and 8 min shows on the display).
- 4 Close the Drawer and Press the **Start/Pause** button to start the Spin.

## Child Lock

Use this option to disable the controls. This feature can prevent children from changing cycles or operating the appliance.

### Locking the Control Panel

- 1 Press and hold the **Child Lock** button for three seconds.
- 2  will appear on the display. When the Child Lock is set, all buttons are locked except the **Power** button.

### NOTE

- Turning off the power or completing all cycles will not reset the child lock function. You must deactivate child lock before you can access any other functions.

### Unlocking the Control Panel

Press and hold the **Child Lock** button for three seconds.

- To change the cycle or option, press the **Start/Pause** button to stop operation, and then choose the cycle or option which you wish to change.

## LG ThinQ Application

### Installing the LG ThinQ Application

Search for the LG ThinQ application from the Google Play Store or Apple App Store on a smartphone. Follow instructions to download and install the application.



### LG ThinQ Application Features

Communicate with the appliance from a smartphone using the convenient smart features.

#### Smart Diagnosis

This function provides useful information for diagnosing and solving issues with the appliance based on the pattern of use.

### Smart Diagnosis

This feature is only available on models with the  or  logo.

Use this feature to help you diagnose and solve problems with your appliance.



#### NOTE

- The feature may be subject to change without prior notice and may have a different form depending on where you are located.
- For reasons not attributable to LGE's negligence, the service may not operate due to external factors such as, but not limited to, Wi-Fi unavailability, Wi-Fi disconnection, local app store policy, or app unavailability.

## Using Audible Diagnosis to Diagnose Issues

Follow the instructions below to use the audible diagnosis method.

- Launch the **LG ThinQ** application and select the **Smart Diagnosis** feature in the menu. Follow the instructions for audible diagnosis provided in the LG ThinQ application.

- 1 Press the **Power** button to turn on the appliance.
  - Do not press any other buttons.
- 2 Place the mouthpiece of your smartphone close to the  or  logo.

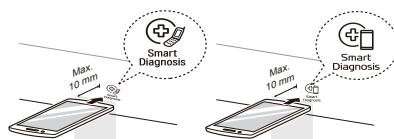

- 3 Press and hold the **Extra Rinse** button for 3 seconds or longer while holding the smartphone mouthpiece to the logo until the data transfer is complete.
  - Keep the smartphone in place until the data transfer has finished. Time remaining for data transfer is displayed.
- 4 After the data transfer is complete, the diagnosis will be displayed in the application.

#### NOTE

- For best results, do not move the smartphone while the tones are being transmitted.

## **⚠ WARNING**

- Unplug the washing machine before cleaning to avoid the risk of electric shock. Failure to follow this warning may result in serious injury, fire, electric shock, or death.
- Never use harsh chemicals, abrasive cleaners, or solvents to clean the washing machine. They may damage the finish.

## Cleaning Your Washing Machine

### Care After Wash

- After the cycle is finished, wipe the door and the inside of the door seal to remove any moisture.
- Leave the door open to dry the drum interior if it is safe to do so.
- Wipe the body of the washing machine with a dry cloth to remove any moisture.

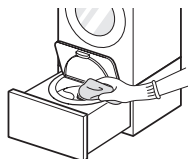

### Cleaning the Exterior

Proper care of your washing machine can extend its life.

**Door:** (Turn off the Main power to the washer before commencing any cleaning)

- Wash with a damp cloth on the outside and inside and then dry with a soft cloth.

**Exterior:**

- Immediately wipe off any spills.
- Wipe with a damp cloth.
- Do not press on the surface or the display with sharp objects.

## Cleaning the Interior

- Use a towel or soft cloth to wipe around the washing machine door opening and door glass.
- Care should be taken when removing items from the tub after the wash as sharp objects such as zippers can damage the door seal if not exercised.
- Always remove items from the washing machine as soon as the cycle is complete. Leaving damp items in the washing machine can cause wrinkling, colour transfer, and odour.
- Run the Tub Clean programme once a month (or more often if needed) to remove detergent buildup and other residue that can cause odors. The Tub clean reminder alert **T.C.A.** will appear on the display after a predetermined number of washes.

## Tub Clean

Use this option to keep the drum clean by sterilizing germs within the drum when the alert appears on the display, or as required. **Err**

- 1 Press the **Power** button.
- 2 Dilute 200 ml liquid chlorine bleach in 1 ℓ of water and pour the mixture in the drum.
- 3 Select the **Tub Clean** programme.
- 4 Press the **Start/Pause** button.

### **!** CAUTION

- Do not leave the washer's Lid, or drawer open if there is an unsupervised child nearby.

## Cleaning the Water Inlet Filter

- Turn off the water supply tap if the washing machine is to be left for any length of time (e.g. holiday), especially if there is no floor drain (gully) in the immediate vicinity.
  - **IE** icon may mesh on the display when the water pressure is weak or an inlet filter is clogged with dirt. Clean the inlet filter.
  - The inlet filter screens could be clogged by hard water scale, sediment in the water supply, or other debris.
- 1 Turn off the water tap and unscrew the water inlet hose.

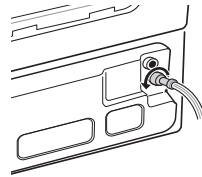

- 2 Clean the filter using a medium bristle toothbrush.

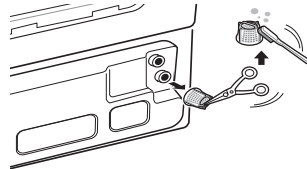

## Cleaning the Lint Filter

The filter is an important part for efficient washing performance result, so it needs special care from you. It is recommended that the filter be cleaned regularly.

- 1 Pull the cap of the lint filter.

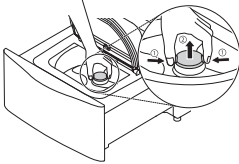

- 2 Squeeze the release tabs on the sides of the cap and lift the cap up. Remove the lint and rinse out the filter.

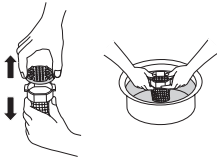

- 3 To refit, insert the lower part of the filter into the drum and close the cap until you hear a click sound.

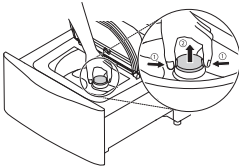

## NOTE

- If the lint filter is damaged, contact an LG service centre.
- Do not operate the washing machine without the lint filter.
- Refit the lint filter securely. Not doing so may damage the fabrics or the washing machine.

## Care in Cold Climates

- When frozen, the product does not operate normally. Make sure to install the product where it will not freeze during winter.

## How to Keep the Product from Freezing

- After closing the tap, disconnect the cold supply hose from the tap, and remove water while keeping the hose facing downwards.

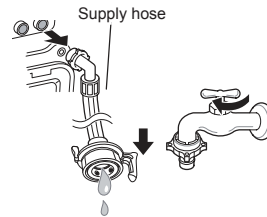

## How to Manage the machine in Freezing conditions

### Step 1. When the Door is Frozen

- Thaw out the door using a hot water cloth.

### Step 2. When the Water Supply Hose is Frozen

- **FE** icon may blink on the display when water supply problems occur, take the following measures.
  - Take out water supply hose and connect to the tap and check that water comes from the tap and supply hose.
  - Turn off the tap, and thaw out the tap and both connection areas of supply hose of the product using a hot water cloth.
  - Take out supply hose and immerse in warm water below 50–60 °C.

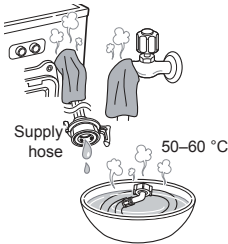

### Step 3. When the Drain Pump is Frozen

- **FF**, **DE** icon may blink on the display when drain pump problems occur, take the following measures.

- 1 Pour 15 ℓ warm water below 50–60 °C in the drum.
- 2 Select the **Rinse+Spin** programme and press the **Start/Pause** button to check that the washing machine works.
- 3 When **DE** icon appears on the display, thaw out the drain hose inner part with the hot water.

The appliance is equipped with an automatic error-monitoring system to detect and diagnose problems at an early stage. If the appliance does not function properly or does not function at all, check the following before you call for service:

## Diagnosing Problems

Symptoms	Reason	Solution
<b>Rattling and clanking noise</b>	<b>Foreign objects, such as keys, coins, or safety pins may be in drum.</b>	<ul style="list-style-type: none"> <li>• Stop washing machine, check drum for foreign objects. If noise continues after washing machine is restarted, call for service.</li> </ul>
<b>Thumping sound</b>	<b>Full wash loads may produce a thumping sound.</b>	<ul style="list-style-type: none"> <li>• If sound continues, washing machine is probably out of balance. Stop and redistribute wash load.</li> </ul>
	<b>Wash load may be out of balance.</b>	<ul style="list-style-type: none"> <li>• Pause the cycle and redistribute the load after the door unlocks.</li> </ul>
<b>Vibrating noise</b>	<b>Packaging materials were not removed.</b>	<ul style="list-style-type: none"> <li>• Remove packing materials</li> </ul>
	<b>Wash load may be unevenly distributed in the drum.</b>	<ul style="list-style-type: none"> <li>• Pause the cycle and redistribute the load after the door unlocks.</li> </ul>
	<b>Not all leveling feet are resting firmly and evenly on the floor.</b>	<ul style="list-style-type: none"> <li>• See Leveling the Appliance in the Installation section.</li> </ul>
	<b>Floor not rigid enough.</b>	<ul style="list-style-type: none"> <li>• Make sure that the floor is solid and does not flex.</li> </ul>
<b>Water leaks every load</b>	<b>Hoses not installed correctly.</b>	<ul style="list-style-type: none"> <li>• Check all fill and drain hose connections to ensure that they are tight and secure.</li> </ul>
<b>Excessive sudsing</b>	<b>Too much detergent or incorrect detergent.</b>	<ul style="list-style-type: none"> <li>• Reduce the amount of detergent for lightly soiled laundry. If you use too much detergent, excessive bubbles will remain after rinsing.</li> </ul>
<b>Staining</b>	<b>Clothes were not properly sorted.</b>	<ul style="list-style-type: none"> <li>• Always wash dark colors separately from light colors and whites to prevent discoloration.</li> </ul>





Symptoms	Reason	Solution
Water leaking	Supply hose connection is loose at the tap, washing machine, or drain hose connector.	<ul style="list-style-type: none"> <li>• Check hoses and drain hose connectors for leaks, cracks and splits.</li> <li>• Tighten hose connections.</li> </ul>
	House drain pipes are clogged.	<ul style="list-style-type: none"> <li>• The washing machine pumps out water very rapidly. Check for water backing up out of the drain pipe during drain. If water is seen coming out of the drain, check for proper drain hose installation and check for restrictions in the drain. Contact a plumber to repair drain pipe.</li> </ul>
	Drain hose has come out of drain connector or is not inserted far enough.	<ul style="list-style-type: none"> <li>• Tie drain hose to supply hose or standpipe to prevent it from coming out during drain. For smaller drain pipes, insert the drain hose into the pipe as far as the drain hose flange. For larger drain pipes, insert the drain hose into the pipe 2-5 cm past the flange.</li> </ul>
	Load is too large for the drum.	<ul style="list-style-type: none"> <li>• Reduce the load or use the front-loading washing machine.</li> <li>• Stop the washing machine and check the load. Make sure the load fits loosely in the drum and the door closes easily.</li> </ul>
Wrinkling	Washing machine not unloaded promptly.	<ul style="list-style-type: none"> <li>• Always remove items from the washing machine as soon as the cycle is complete.</li> </ul>
	Washing machine overloaded.	<ul style="list-style-type: none"> <li>• The washing machine can be fully loaded, but the drum should not be tightly packed with items. The door of the washing machine should close easily.</li> </ul>
Water leaks	Oversudsing of detergent.	<ul style="list-style-type: none"> <li>• Oversudsing may create leaks, and may be caused by the type and amount of detergent used. Always reduce the amount of detergent if the load is small, or if your water is very soft. Never use more than the maximum amount shown in the dispenser provided.</li> </ul>









Symptoms	Reason	Solution
<b>Washing machine not filling properly</b>	<b>Filter clogged.</b>	<ul style="list-style-type: none"> <li>• Make sure the inlet filter on the fill valve is not clogged. Refer to the filter cleaning instructions.</li> </ul>
	<b>Supply hose may be kinked.</b>	<ul style="list-style-type: none"> <li>• Check that supply hose is not kinked or clogged.</li> </ul>
	<b>Insufficient water supply.</b>	<ul style="list-style-type: none"> <li>• Make sure that cold water tap is turned on all the way.</li> </ul>
	<b>door and drawer are open.</b>	<ul style="list-style-type: none"> <li>• The washing machine will not operate if the Lid is open. Close the Lid and make sure that nothing is caught under the Lid preventing it from closing completely.</li> </ul>
	<b>Water level is too low.</b>	<ul style="list-style-type: none"> <li>• The fill level is optimized for the wash motion to achieve the best wash performance.</li> </ul>

Symptoms	Reason	Solution
Washing machine will not operate	<b>Control panel has powered off due to inactivity.</b>	<ul style="list-style-type: none"> <li>This is normal. Press the Power button to turn the washing machine on.</li> </ul>
	<b>Washing machine is unplugged.</b>	<ul style="list-style-type: none"> <li>Make sure cord is plugged securely into a working outlet.</li> </ul>
	<b>Water supply is turned off.</b>	<ul style="list-style-type: none"> <li>Turn cold tap fully on.</li> </ul>
	<b>Controls are not set properly.</b>	<ul style="list-style-type: none"> <li>Make sure the cycle was set correctly, close the door and press the Start/Pause button.</li> </ul>
	<b>Door or drawer is open.</b>	<ul style="list-style-type: none"> <li>Close the door and drawer make sure that nothing is caught under the door preventing it from closing completely.</li> </ul>
	<b>Circuit breaker/fuse is tripped/blown.</b>	<ul style="list-style-type: none"> <li>Check house circuit breakers/fuses. Replace fuses or reset breaker. The washing machine will resume the cycle where it stopped once power is restored.</li> </ul>
	<b>Control needs to be reset.</b>	<ul style="list-style-type: none"> <li>Press the Power button, then re-select the desired programme and press the Start/Pause button.</li> </ul>
	<b>Start/Pause was not pressed after a cycle was set.</b>	<ul style="list-style-type: none"> <li>Press the Power button then re-select the desired programme and press the Start/Pause button. If the <b>Start/Pause</b> button is not pressed within a certain time, the appliance will shut off and all settings will be lost.</li> </ul>
	<b>Extremely low water pressure.</b>	<ul style="list-style-type: none"> <li>Check another tap in the house to make sure that household water pressure is adequate.</li> </ul>
	<b>Washing machine is too cold.</b>	<ul style="list-style-type: none"> <li>If the washing machine has been exposed to temperatures below freezing for an extended period of time, allow it to warm up before pressing the Power button.</li> </ul>

Symptoms	Reason	Solution
Washing machine will not drain water	<b>Kinked drain hose.</b>	<ul style="list-style-type: none"> <li>• Ensure that the drain hose is not kinked.</li> </ul>
	<b>Drain located higher than 100 cm above the floor.</b>	<ul style="list-style-type: none"> <li>• Make sure that the drain hose is no higher than 100 cm above the bottom of the washing machine and is no more than 1.5 m away from the washing machine.</li> </ul>
Poor stain removal	<b>Normal and heavily soiled load.</b>	<ul style="list-style-type: none"> <li>• Use the main washing machine to wash normal and heavily soiled loads.</li> </ul>
	<b>Previously set stains.</b>	<ul style="list-style-type: none"> <li>• Articles that have previously been washed may have stains that have been set. These stains may be difficult to remove and may require hand washing or pre-treating to aid in stain removal.</li> </ul>
Wash cycle time is longer than usual	<b>The washing machine automatically adjusts the wash time for the amount of laundry, water pressure and other operating conditions.</b>	<ul style="list-style-type: none"> <li>• This is normal. The washing machine adjusts cycle time automatically to provide optimal results for the selected programme. The time remaining shown in the display is only an estimate. Actual time may vary.</li> </ul>
Musty or mildewy odor in washing machine	<b>Incorrect or too much detergent has been used.</b>	<ul style="list-style-type: none"> <li>• This machine requires very little detergent. Use the provided detergent measuring cup.</li> </ul>
	<b>Inside of drum was not cleaned properly.</b>	<ul style="list-style-type: none"> <li>• Run the Tub clean programme regularly.</li> </ul>
Washing machine chimes repeatedly before final rinse	<b>This is not an error.</b>	<ul style="list-style-type: none"> <li>• This is an alert to allow the addition of liquid fabric softener before the final rinse.</li> </ul>

## Error Messages

Symptoms	Reason	Solution
 	<b>Drawer is not closed properly.</b>	<ul style="list-style-type: none"> <li>• Close the drawer and press Start/Pause button to start the cycle.</li> <li>• If the drawer is closed and the drawer lock error message is displayed, call for service.</li> </ul>
	<b>Lid is not closed properly.</b>	<ul style="list-style-type: none"> <li>• Open the drawer and make sure the latch area is free of clothing or other obstructions.</li> <li>• Close the Lid, shut the drawer, and press Start/Pause to start the cycle.</li> <li>• If the Lid is closed and the Lid error message is displayed, call for service.</li> </ul>
	<b>Water supply tap is not fully open.</b>	<ul style="list-style-type: none"> <li>• Make sure that the water tap is fully open.</li> </ul>
	<b>Water line hose is kinked, pinched, or crushed.</b>	<ul style="list-style-type: none"> <li>• Make sure that the hose is not kinked or pinched. Be careful when moving the washing machine during cleaning and maintenance.</li> </ul>
	<b>Water inlet filter is clogged.</b>	<ul style="list-style-type: none"> <li>• Clean the inlet filter.</li> </ul>
	<b>Water supply pressure to tap or house is too low.</b>	<ul style="list-style-type: none"> <li>• Check another tap in the house to make sure that household water pressure is adequate and flow is not restricted. Disconnect the supply hose from the washing machine and run a few liters of water through the hose to flush the water supply lines. If flow is too low, contact a plumber to have the water lines repaired.</li> </ul>
	<b>Water supply connected with leak-limiting hoses.</b>	<ul style="list-style-type: none"> <li>• Hoses designed to limit leaks can trip falsely and prevent the washing machine from filling. The use of leak limiting hoses is not recommended.</li> </ul>
	<b>Drain hose is kinked, pinched, or clogged.</b>	<ul style="list-style-type: none"> <li>• Make sure the drain hose is free of clogs, kinks, etc., and is not pinched behind or under the washing machine.</li> </ul>
	<b>Drain discharge is more than 100 cm above bottom of washing machine.</b>	<ul style="list-style-type: none"> <li>• Adjust or repair drain. Maximum drain height is 100 cm.</li> </ul>

Symptoms	Reason	Solution
	<b>UE rebalancing operation was not successful.</b>	<ul style="list-style-type: none"> <li>The automatic attempt to rebalance the load was not successful. The cycle has been paused to allow the load to be manually adjusted.</li> </ul>
	<b>The load is too small.</b>	<ul style="list-style-type: none"> <li>Add more items to allow the washing machine to balance the loads.</li> </ul>
	<b>Heavy articles are mixed with lighter items.</b>	<ul style="list-style-type: none"> <li>Wash articles of somewhat similar weight.</li> </ul>
	<b>The load is out of balance.</b>	<ul style="list-style-type: none"> <li>Manually redistribute the load if articles have become tangled.</li> </ul>
	<b>Control error.</b>	<ul style="list-style-type: none"> <li>Unplug the power plug and call for service.</li> </ul>
	<b>Water level is too high due to a faulty water valve.</b>	<ul style="list-style-type: none"> <li>Close the water taps, unplug the washing machine, and call for service.</li> </ul>
	<b>The water level sensor is not working correctly.</b>	<ul style="list-style-type: none"> <li>Close the water tap, unplug the washing machine, and call for service.</li> </ul>
	<b>A motor error has occurred.</b>	<ul style="list-style-type: none"> <li>Allow the washing machine to stand for 30 minutes and then restart the cycle. If the LE error code persists, call for service.</li> </ul>
	<b>It is time to run the Tub Clean programme.</b>	<ul style="list-style-type: none"> <li>Run the Tub Clean programme.</li> </ul>
	<b>There is no Main washing machine placed on top of the Mini Washer.</b>	<ul style="list-style-type: none"> <li>Mini Washer will not operate as a standalone unit. It must be stacked under the matching LG front-loading washing machine.</li> </ul>
	<b>Stacking switch is not working properly.</b>	<ul style="list-style-type: none"> <li>The stacking switch will not operate properly if the unit is stacked under a non-LG appliance, or an LG appliance manufactured before 2009.</li> </ul>
	<b>Drain hose, supply hose or drain pump is frozen.</b>	<ul style="list-style-type: none"> <li>Thaw out the supply hose using a hot water cloth.</li> <li>Pour warm water in the drum.</li> </ul>
	<b>CL is not an error. This prevents children from changing cycles or operating the appliance.</b>	<ul style="list-style-type: none"> <li>To deactivate, press the <b>Child lock</b> button for three seconds.</li> </ul>

# Memo

