

Owner's Guide

Projection Television Models
WS-55908 and WS-65908



Technically Anything is Possible®

visit our website at

www.mitsubishi-tv.com



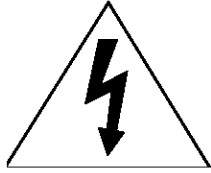

CAUTION

RISK OF ELECTRIC SHOCK
DO NOT OPEN



CAUTION: TO REDUCE THE RISK OF ELECTRIC SHOCK,
DO NOT REMOVE COVER (OR BACK).
NO USED SERVICEABLE PARTS INSIDE.
REFER SERVICING TO QUALIFIED SERVICE PERSONNEL

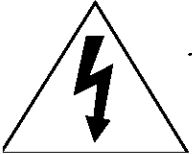

The lightning flash with arrowhead symbol within an equilateral triangle is intended to alert the user of the presence of uninsulated "dangerous voltage" within the product's enclosure that may be sufficient magnitude to constitute a risk of electric shock.



The exclamation point within an equilateral triangle is intended to alert the user to the presence of important operating and maintenance (servicing) instructions in the literature accompanying the appliance.

Warning: To avoid permanently imprinting a fixed image onto your TV screen, please do not display the same stationary images on the screen for more than 15% of your total TV viewing in one week. Examples of stationary images are letterbox top/bottom bars from DVD disk or other video sources, side bars when showing standard TV pictures on widescreen TV's, stock market reports, video game patterns, station logos, web sites or stationary computer images. Such patterns can unevenly age the picture tubes causing permanent damage to the TV. Please see pages 23 and 68 for a detailed explanation.

Note: This equipment has been tested and found to comply with the limits for a Class B digital device, pursuant to part 15 of the FCC Rules. These limits are designed to provide reasonable protection against harmful interference in a residential installation. This equipment generates, uses and can radiate radio frequency energy and, if not installed and used in accordance with the instructions, may cause harmful interference to radio communications. However, there is no guarantee that interference will not occur in a particular installation. If this equipment does cause harmful interference to radio or television reception, which can be determined by turning the equipment off and on, the user is encouraged to try to correct the interference by one or more of the following measures:

- Reorient or relocate the receiving antenna.
- Increase the separation between the equipment and the receiver.
- Connect the equipment into an outlet on a circuit different from that to which the receiver is connected.
- Consult the dealer or an experienced radio/TV technician for help.

CAUTION: To assure continued FCC compliance, the user must use a shielded video interface cable with bonded ferrite cores, when using the VGA input.

Changes or modifications not expressly approved by Mitsubishi could void the user's authority to operate this equipment.

WARNING:

TO REDUCE THE RISK OF FIRE OR ELECTRIC SHOCK, DO NOT EXPOSE THIS APPLIANCE TO RAIN OR MOISTURE.

CAUTION:

TO PREVENT ELECTRIC SHOCK, MATCH WIDE BLADE OF PLUG TO WIDE SLOT, FULLY INSERT.

NOTE TO CATV SYSTEM INSTALLER:

THIS REMINDER IS PROVIDED TO CALL THE CATV SYSTEM INSTALLER'S ATTENTION TO ARTICLE 820-40 OF THE NEC THAT PROVIDES GUIDELINES FOR THE PROPER GROUNDING AND, IN PARTICULAR, SPECIFIES THAT THE CABLE GROUND SHALL BE CONNECTED TO THE GROUNDING SYSTEM OF THE BUILDING, AS CLOSE TO THE POINT OF CABLE ENTRY AS PRACTICAL.



IMPORTANT SAFEGUARDS4-5

Thank You Letter 8

Unpacking Your New TV 9

Special Features 9

Front Control Panel Functions 12

Back Panel Functions 13

How Connections Affect:

 PIP and POP 14

 System 4 Home Theater IR Control..... 14-15

Connecting to Your New Mitsubishi Bigscreen:

 Antenna or Wall Outlet Cable 16

 Cable Box..... 16

 VCR 17

 Audio Receiver 18

 DVD Player or S-Video Device 19

 DTV Receiver..... 20-21

 Computer..... 22

 System 4 Home Theater IR Control..... 22

IMPORTANT NOTES #1 23

Programming the Remote Control: To Control Other A/V Products 26-27

Programming the Remote Control: To Activate the System 4 Home Theater IR Control 28-29

on-screen menu system 30

 Using 30

Menu Screens (Overview)..... 31-32

Setup Menu..... 33

 Memorize Channels 33

 Assign Input..... 33

 Language 33

Closed Captions Menu 34

Channel Menu 35

V-Chip Lock 36-38

Advanced Menu..... 39

 Timer..... 39

 Convergence..... 40-41

Audio/Video Menu 42-43

Clock Menu 44-45

A/V Setting Descriptions 46-47

Remote Control Functions 50-57

 Overview 50

 Care and Operation 51

 Channel Selection..... 52

 Sleep Timer..... 52

 System 4 Home Theater IR Control..... 53

 Special Functions 54

 Operation of PIP and POP..... 54-55

 Display Formats 56-57

IMPORTANT NOTES #2 58

Appendix A: Bypassing the V-Chip Lock 59

Appendix B: High Definition Input sConnection Compatibility 61

Appendix C: Remote Control Programing Codes 62

Appendix D: Cleaning and Service 63

Appendix E: Troubleshooting..... 64

Index..... 65-66

Mitsubishi Projection TV Limited Warranty 67



IMPORTANT SAFEGUARDS

Please read the following safeguards for your TV and retain for future reference.

Always follow all warnings and instructions marked on the television.

1. Read, Retain and Follow All Instructions

Read all safety and operating instructions before operating the TV. Retain the safety and operating instructions for future reference. Follow all operating and use instructions.

2. Heed Warnings

Adhere to all warnings on the appliance and in the operating instructions.

3. Cleaning

Unplug the TV from the wall outlet before cleaning. Do not use liquid, abrasive, or aerosol cleaners. Cleaners can permanently damage the cabinet and screen. Use a lightly dampened cloth for cleaning.

4. Attachments and Equipment

Never add any attachments and/or equipment without approval of the manufacturer as such additions may result in the risk of electrical shock or other personal injury.

5. Water and Moisture

Do not use the TV where contact with or immersion in water is possible. Do not use near bath tubs, wash bowls, kitchen sinks, laundry tubs, swimming pools, etc.

6. Accessories



Do not place the TV on an unstable cart, stand, tripod, or table. The TV may fall, causing serious injury to a child or adult and serious damage to the TV. Use only with a cart, stand, tripod, bracket, or table recommended by the manufacturer, or sold with the TV. Any mounting of the TV should follow the manufacturer's instructions, and should use mounting accessories recommended by the manufacturer.

An appliance and cart combination should be moved with care. Quick stops, excessive force, and uneven surfaces may cause the appliance and cart combination to overturn.

7. Ventilation

Slots and openings in the cabinet are provided for ventilation and to ensure reliable operation of the TV and to protect it from overheating. Do not block these openings or allow them to be obstructed by placing the TV on a bed, sofa, rug, or other similar surface. Nor should it be placed over a radiator or heat register. If the TV is to be placed in a rack or bookcase, ensure that there is adequate ventilation and that the manufacturer's instructions have been adhered to.

8. Power Source

This TV should be operated only from the type of power source indicated on the marking label. If you are not sure of the type of power supplied to your home, consult your appliance dealer or local power company.

9. Grounding or Polarization

This TV is equipped with a polarized alternating current line plug having one blade wider than the other. This plug will fit into the power outlet only one way. If you are unable to insert the plug fully into the outlet, try reversing the plug. If the plug should still fail to fit, contact your electrician or replace your outlet. Do not defeat the safety purpose of the polarized plug.

10. Power-Cord Protection

Power-supply cords should be routed so that they are not likely to be walked on or pinched by items placed upon or against them, paying particular attention to cords at plugs, convenience receptacles, and the point where they exit from the TV.

11. Lightning

For added protection for this TV during a lightning storm, or when it is left unattended and unused for long periods of time, unplug it from the wall outlet and disconnect the antenna or cable system. This will prevent damage to the TV due to lightning and power-line surges.

IMPORTANT SAFEGUARDS Continued



12. Power Lines

An outside antenna system should not be located in the vicinity of overhead power lines or other electric light or power circuits, or where it can fall into such power lines or circuits. When installing an outside antenna system, extreme care should be taken to keep from touching such power lines or circuits as contact with them might be fatal.

13. Overloading

Do not overload wall outlets and extension cords as this can result in a risk of fire and electric shock.

14. Object and Liquid Entry

Never push objects of any kind into this TV through openings as they may touch dangerous voltage points or short-out parts that could result in fire and electric shock. Never spill liquid of any kind on or into the TV.

15. Outdoor Antenna Grounding

If an outside antenna or cable system is connected to the TV, be sure the antenna or cable system is grounded so as to provide some protection against voltage surges and built-up static charges.

Section 810 of the National Electric Code, ANSI/NFPA No. 70-1984, provides information with respect to proper grounding of the mast and supporting structure, grounding of the lead in wire to an antenna discharge unit, size of grounding conductors, location of antenna discharge unit, connection to grounding electrodes, and requirements for the grounding electrode.

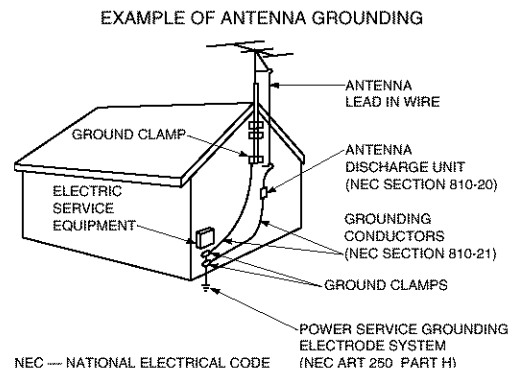

16. Servicing

Do not attempt to service this TV yourself as opening or removing covers may expose you to dangerous voltage or other hazards. Refer all servicing to qualified service personnel.

17. Damage Requiring Service

Unplug the TV from the wall outlet and refer servicing to qualified service personnel under the following conditions:

- When the power-supply cord or plug is damaged.
- If liquid has been spilled, or objects have fallen into the TV.
- If the TV has been exposed to rain or water.
- If the TV does not operate normally by following the operating instructions, adjust only those controls that are covered by the operating instructions as an improper adjustment of other controls may result in damage and will often require extensive work by a qualified technician or reset the TV to its normal operation.
- If the TV has been dropped or the cabinet has been damaged.
- When the TV exhibits a distinct change in performance - this indicates a need for service.

18. Replacement Parts

When replacement parts are required, be sure the service technician has used replacement parts specified by the manufacturer or have the same characteristics as the original part. Unauthorized substitutions may result in fire and electric shock or other hazards.

19. Safety Check

Upon completion of any service or repair to the TV, ask the service technician to perform safety checks to determine that the TV is in safe operating condition.

20. Heat

The product should be situated away from heat sources such as radiators, heat registers, stoves, or other products (including amplifiers) that produce heat.

If you have questions regarding your television, call
Consumer Relations
at (800) 332-2119, or email us at
MDEAservice@bigscreen.mea.com

To order replacement or additional remote controls or owner's
guides
call (800) 553-7278

or

visit our website at www.mitsubishi-tv.com

Part 1

Thank You

Thank You Letter	8
Unpacking Your New TV	9
Special Features	9



We at Mitsubishi Would Like to Thank You

To the Mitsubishi Consumer:

Thank you for choosing Mitsubishi as your premier home entertainment partner. Whether this is your first Mitsubishi consumer electronics product or an addition to your growing Mitsubishi family, you should be proud and delighted for choosing one of the most technologically advanced bigscreens available today.

Unlike typical television manufacturers, we have based our primary design and engineering capabilities in North America at our California headquarters. As a result, the engineers who design our television products live in the same communities as our customers. They know how our customers think and what their goals and desires are. They know that today's consumer has never been more sophisticated and that the way to reach that consumer is to deliver technically advanced products at prices that our competition simply can't match.

When you look at your new Mitsubishi bigscreen television, please see all of us who built it, because when we build it, we see you.

Thank You Again,
The Mitsubishi Team

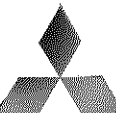

Unpacking Your New TV

Please take a moment to review the following list of items to ensure that you have received everything included:

- 1 Remote Control
- 2 (2) AAA Batteries
- 3 (3) IR Emitter Cables
- 4 Product Registration Card
- ➔ Owner's Guide
- ➔ Quick Reference Card

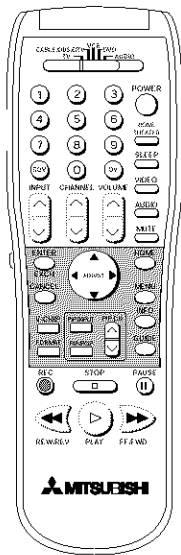

1 Remote Control

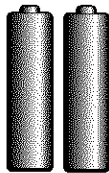

2 (2) AAA Batteries

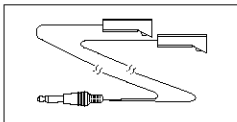

3 (3) IR Emitter Cables



4 Product Registration Card

Special Features

Your new HD-Upgradeable bigscreen television has many special features that make it the perfect addition to your home entertainment system. Below we have highlighted a handful.

HD-Upgradeable

With the use of an optional HDTV receiver like the Mitsubishi SR-HD500 or similar model, your Mitsubishi bigscreen can display high definition pictures.

See pages 20 & 21.

Wide Screen Picture Format

You will be able to view pictures as the directors intended you to see them. Both DTV and DVD's supporting the widescreen format will enable you to enjoy a theater feel in the comfort of your home.

See pages 56-57.

PIP/POP Viewing Option

Using Picture-in-Picture and Picture-outside-Picture will give you exciting options for viewing your favorite programs.

See pages 54-55.

V-Chip Technology

Mitsubishi understands that you may want to shield certain viewers from specific content. Your Mitsubishi bigscreen will allow you to restrict Programming by general contents, specific content, or even by time.

See pages 36-38.

Multibrand Remote Control

Your Mitsubishi remote control can be programmed to control many other audio/video components.

See page 26 & 27.

Unlike typical television manufacturers, we have based our primary design and engineering capabilities in North America at our California headquarters. As a result, the engineers who design our television products live in the same communities as our customers. They know how our customers think and what their goals and desires are. They know that today's consumer has never been more sophisticated and that the way to reach that consumer is to deliver technically advanced products at prices that our competition simply can't match.

Part II

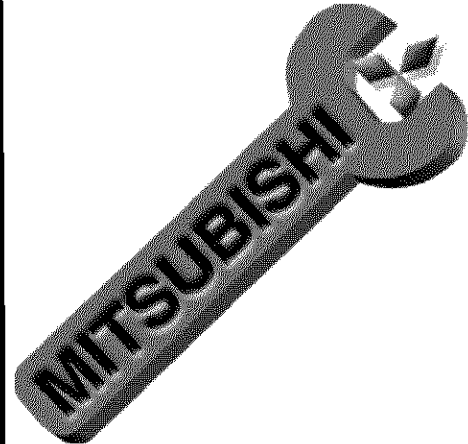

Installation

Front Control Panel Functions 12

Back Panel Functions 13

How Connections Affect:

PIP and POP 14

System 4 Home Theater

IR Control 14-15

Connecting to Your New Mitsubishi Bigscreen:

Antenna or Wall Outlet Cable ... 16

Cable Box 16

VCR 17

Audio Receiver 18

DVD Player 19

S-Video Device 19

DTV Receiver 20-21

Computer 22

System 4 Home Theater



Front Control Panel

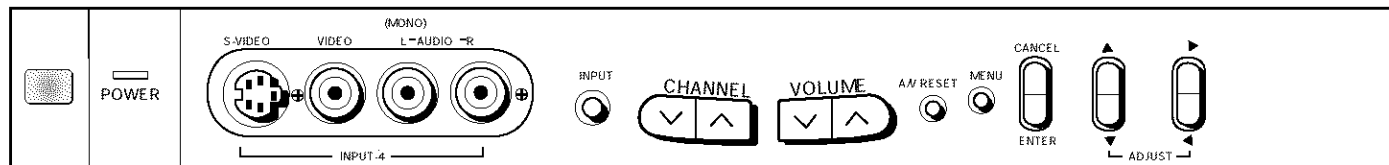

Figure 1. Front Control Panel.

IRIS™

Intelligent Room Illumination (light) Sensor. Turn this feature on or off using the VIDEO button on your remote control. When the IRIS is on, your TV will automatically adjust picture contrast and brightness for the best picture based on your room lighting. When on, do not block the sensor to ensure an optimum picture.

Power (used for Timer function)

During normal operation, the power light will glow steady green when the TV is on, and not glow when the TV is off. When the TV is set to turn on at a specific time, the green power light will blink while the TV is off. Please see *Timer*, page 39, for timer setup instructions.

A/V Reset

Press this button to reset the A/V memory on all eleven inputs to the factory default settings. Please see *A/V Memory Reset*, page 42, for instructions.

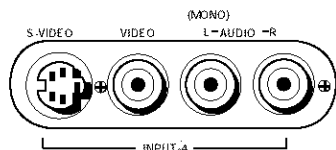

Input 4

This input can be used for convenient connection of a camcorder or other video device to the TV. Please note that if you connect to the S-VIDEO terminal, the VIDEO terminal is deactivated. The VIDEO terminal is active when there is no S-Video connection.

Back Panel

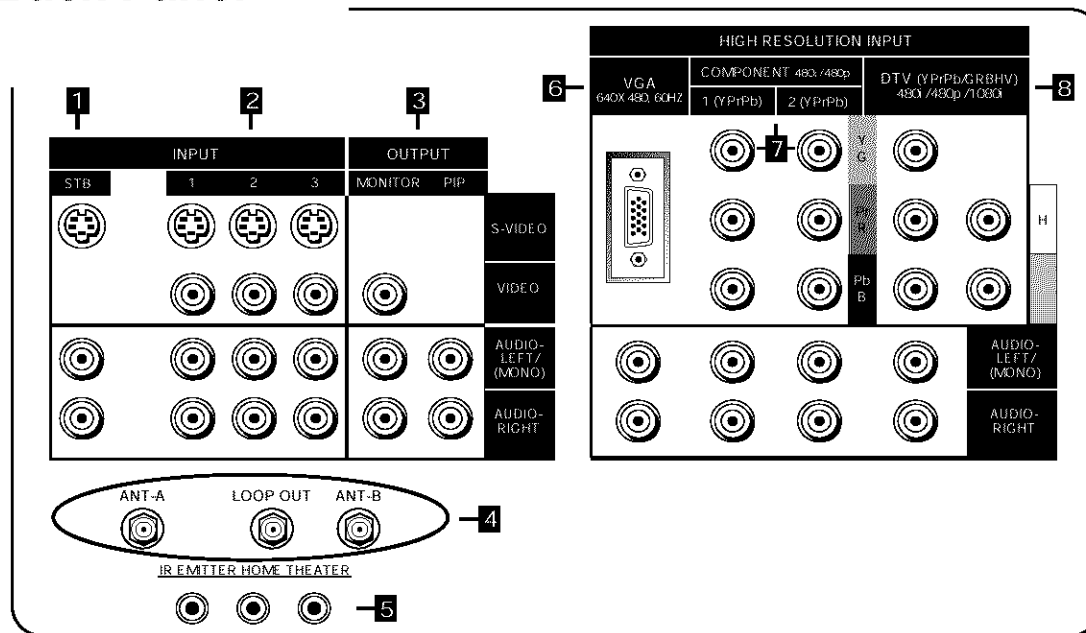

1 STB (Set-Top-Box)

This input can be used for the connection of any device with an S-Video output.

2 Inputs 1-3

These inputs can be used for the connection of a VCR, Super VHS (S-VHS) VCR, laser disc player, or other A/V device to the TV. Please note that if you connect to the S-VIDEO terminal, the VIDEO terminal is deactivated. The VIDEO terminal is active when there is no S-Video connection.

3 Output (Monitor and PIP)

The Monitor Output sends the TV audio and video signals, excluding component video, VGA, or DTV video, to an A/V receiver or other equipment. The PIP output sends the PIP's or POP's audio signal to an amplifier or wired ear headphones. If no PIP or POP is displayed, the PIP output will send the main picture audio signal.

4 Antenna (ANT-A, LOOP OUT, and ANT-B)

ANT-A and ANT-B receive signals from VHF/UHF antennas or a cable system. LOOP OUT sends the ANT-A signal out to another component, such as a cable box or VCR.

5 IR Emitter Home Theater (System 4 Home Theater IR Control)

Connecting IR emitters here allow the TV to automatically change a digital A/V receiver's input in a home theater setup, and pass IR commands to other A/V devices.

6 VGA

This input can be used for the connection of a computer. Please see *Appendix B*, page 61, for signal compatibility.

7 Component Inputs 1-2

These inputs can be used for the connection of A/V equipment with component video outputs, such as a DVD player. Please see *Appendix B*, page 61, for signal compatibility.

8 DTV Input

This input is used to connect a DTV receiver, and can be configured for HDTV component, RGB sync on green, and RGB plus H&V. Please see *Appendix B*, page 61, for signal compatibility.





How Connections Affect the PIP and POP

To see a picture in the PIP or POP inset, you may need to select an input source. If the only input connected is ANT-A, then both the main picture and the PIP/POP inset will be from that input source. If other video equipment is connected, you may be able to view these input sources as the PIP/POP inset. When connecting your new Mitsubishi bigscreen, it is important to understand which main picture and PIP/POP input sources can and cannot be used together. Table 1 shows which inputs can and cannot be used together and the limitations they may require. To see if 480i, DTV 480p, 1080i, Component-1 or Component-2 480p is being displayed as the main picture, press INFO on the TV remote control. The on-screen display, *Figure 1*, will list 480i, 480p or 1080i when those signals are being received. See *Operation of PIP and POP*, pages 54-55, for operating instructions. An asterisk (*) displayed after the signal type indicates that the signal being received is a non-standard format. A non-standard format signal may or may not display properly in a PIP/POP inset.

PIP/POP MAIN	ANT-A	ANT-B	INPUTS 1-4	COMPONENT INPUTS 1-2	DTV	STB
ANT-A	OK*	NO PIP/POP	OK	OK	OK	OK
ANT-B	OK	OK*	OK	OK	OK	OK
INPUTS 1-4	OK	OK	OK**	OK	OK	OK
COMPONENT INPUTS 1-2	OK	OK	OK	OK**	OK POP NO PIP	OK
DTV	OK	OK	OK	OK	OK**	OK
STB	OK	OK	OK	OK	OK	OK**
VGA	NO PIP					

Table 1. *No Side-by-Side with the same channel.
 **No Side-by-Side with the same input.
 PIP cannot display VGA.

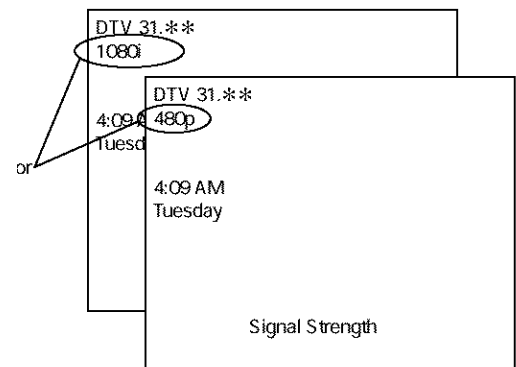

Figure 1. On-screen display will show 480i, 480p, or 1080i when those signals are being received.

How Connections Affect the PIP and POP

How Connections Affect the System 4 Home Theater IR Control

The Mitsubishi System 4 Home Theater IR Control is a special feature that makes it easier to use your TV with a digital surround sound A/V receiver. Once your equipment is properly connected and set up, your TV and digital A/V receiver will change inputs together, to match high resolution pictures with the proper surround sound.

When you change inputs on your TV to watch different video products, your TV will send signals via your remote control and the infrared emitters to your digital A/V receiver

to change inputs. You will automatically hear the high quality digital surround sound from digital products like your DTV receiver and DVD player, and high quality analog stereo or surround sound from non-digital products like your VCR.

Additionally, all IR remote signals from your Mitsubishi remote or other manufacturers remote will be passed through your TV to your A/V devices. Your A/V devices can be hidden or behind cabinet doors and controlled by pointing the remote at the TV.

Special Setups: A/V Equipment (For System 4 Home Theater IR Control)

VCR: Connect the cables to the TV as directed on page 17, with one exception. Connect the audio output connection to the appropriate input on the back of the A/V receiver (as shown in table 1).

DVD: Connect the cables as directed on page 19 (using the COMPONENT-1 input), with one exception. Connect the digital audio output connection on the DVD player to the appropriate digital input on the back of the digital A/V receiver (as shown in table 1).

DTV: Connect the cables as directed on pages 20-21, with one exception. Connect the digital audio output connection on the DTV receiver to the appropriate digital input on the back of the digital A/V receiver (as shown in table 1).

A/V Receiver: Connect as directed on page 18, with two additions. Use a S-Video cable in step 1 if you have a S-Video VCR. The TV outputs should be connected to the A/V receiver's input marked TV.

- Auto Standby:** ON (See your A/V receiver's Owner's Guide for this procedure). For all TV use, the sound will come from the A/V receiver. Not available with all A/V receivers.
- Digital Input Assignment for DVD:** Assign the digital input you used for your DVD player to the A/V receiver's DVD input selector. This procedure is explained in your A/V receiver's Owner's Guide.
- Digital Assignment for DTV:** Assign the digital input you used for DTV to the A/V receiver's DTV input selector.

Infrared Emitter: Connect as shown on page 22.

Special Setups: TV

Menu selection for A/V connections, page 32.

- TV Speakers:** OFF
- Audio Output:** Fixed
- TV Inputs Appropriately Named:** See *Assign Input Menu*, page 33.

Remote Control, pages 26-27.

- Set the slide switch to the TV position and follow the programming instructions using the A/V receiver code appropriate for your A/V receiver, page 27 (gur e5) .

Brand	Model	The products listed at the top of this column connect to the below listed inputs on the back of the appropriate A/V receiver.			
		TV /Cable	SAT/DBS/DTV	VCR	DVD
Mitsubishi	M-VR1000 /M-VR800	TV	VCR2	VCR1	DVD
Mitsubishi	M-VR900 / M-VR700	TV	CABLE /DBS	VCR	DVD
Denon	AVR2800	TV/DBS	VCR2	VCR1	DVD/LD
JVC	RX-888V	TV	VIDEO 2	VCR 1	DVD
Kenwood	VR-2080	AV AUX	LD	VIDEO 1	DVD
Onkyo	TX-DS575	VIDEO 3	VIDEO 2	VIDEO 1	DVD
Pioneer	VSX-21	TV/SAT	VIDEO 2	VCR 1	DVD/LD
Sony	STR-DE825	TV/DBS	VIDEO 2	VIDEO 1	DVD/LD
Yamaha	RX-V2095	TV/DBS	VCR 2	VCR1	DVD/LD

Table 1. A/V receiver back panel input table





Connecting an Antenna, Wall Outlet Cable, or Cable Box

Separate UHF and VHF Antennas

(Figure 1)

- 1 Connect the UHF and VHF antenna leads to the UHF/VHF combiner.
- 2 Push the combiner onto ANT-A on the TV back panel.
- ➔ UHF/VHF combiners are not provided with the TV. They should be available at most electronic stores.

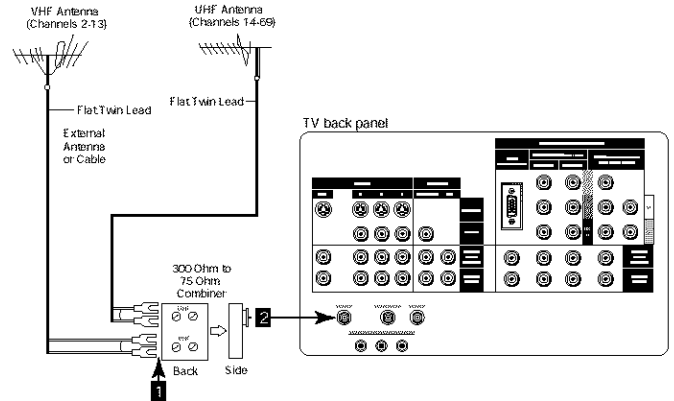

Figure 1. Connecting separate UHF and VHF antennas.

Twin Lead Antenna, Coaxial Lead Antenna, or Wall Outlet Cable

For antenna with twin leads (Figure 1)

- 1 Connect the 300ohm twin leads to the transformer.
- 2 Push the 75ohm side of the transformer onto ANT-A on the TV back panel.
- ➔ 300ohm to 75ohm matching transformers are not provided with the TV. They should be available at most electronic stores.

For cable or antenna with coaxial lead (Figure 2)

- 3 Connect the incoming cable to ANT-A on the TV back panel.

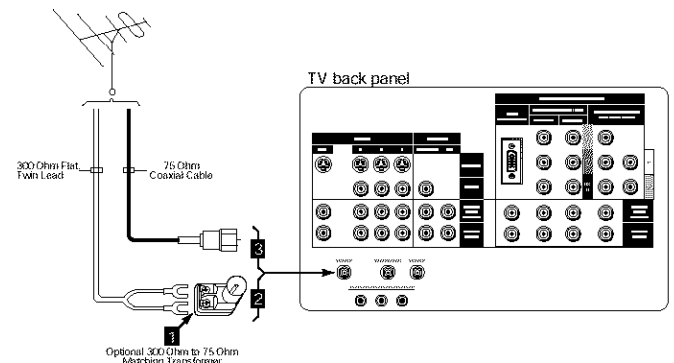

Figure 2. Connecting twin lead antenna, coaxial lead antenna, or wall outlet cable.

IMPORTANT

➔ Additional connection cables are not provided with the TV. They should be available at most electronic stores.

Cable Box

(Figure 3)

- 1 Connect the incoming cable to ANT-A on the TV back panel.
- ➔ Connect two coaxial cables as follows:
 - 2 One from LOOP-OUT on the TV back panel to IN on the cable box back panel.
 - 3 One from OUT on the cable box back panel to ANT-B on the TV back panel.

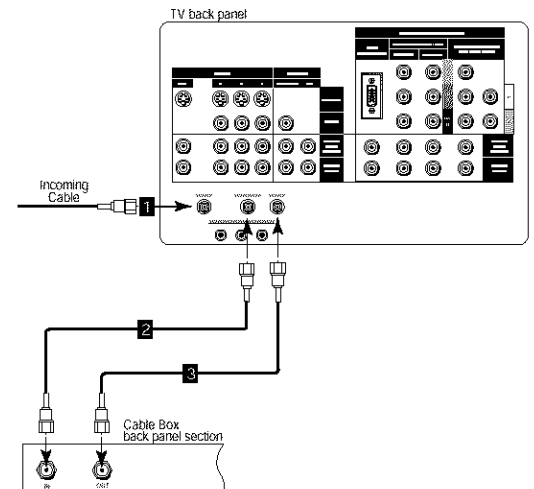

Figure 3. Connecting the cable box.

Connecting a VCR

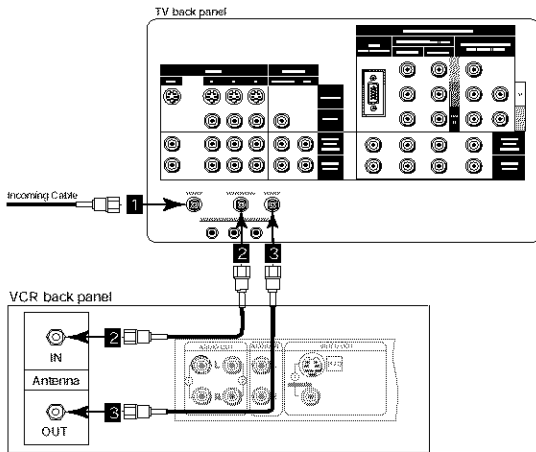

Figure 1. Connecting VCR with antennas or wall outlet cable.

IMPORTANT

➔ Additional connection cables are not provided with the TV. They should be available at most electronic stores.

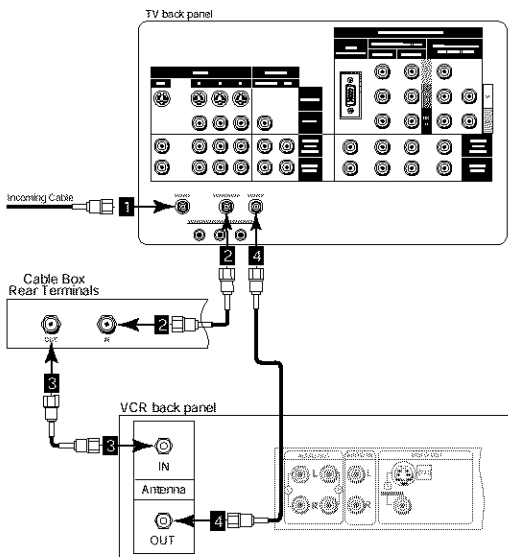

Figure 2. Connecting VCR with cable box.

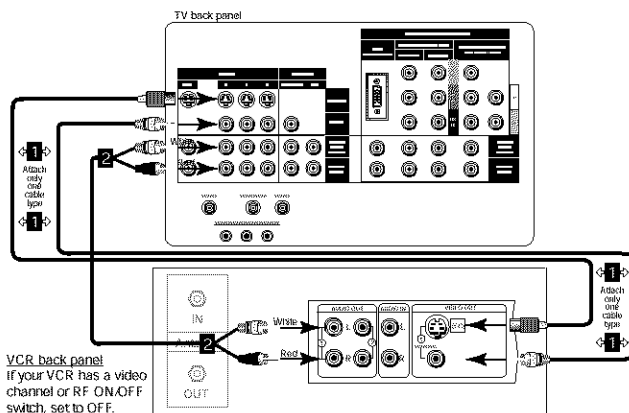

Figure 3. Connecting the VCR Audio/Video.

Antennas or Wall Outlet Cable

(Figure 1)

- ➊ Connect the incoming cable to ANT-A on the TV back panel.
- ➔ Connect two coaxial cables as follows:
 - ➋ One from LOOP-OUT on the TV back panel to ANTENNA IN on the VCR back panel.
 - ➌ One from VCR back panel ANTENNA OUT to ANT-B on the TV back panel.
- ➍ Now complete [Figure 3, steps 1-2](#)

Cable Box

(Figure 2)

- ➊ Connect the incoming cable to ANT-A on the TV back panel.
- ➔ Connect three coaxial cables as follows:
 - ➋ One from LOOP-OUT on the TV back panel to IN on the back of the cable box.
 - ➌ One from OUT on the back of the cable box to ANTENNA IN on the VCR back panel.
 - ➍ One from ANTENNA OUT on the VCR back panel to ANT-B on the TV back panel.
- ➎ Now complete [Figure 3, steps 1-2](#)

Composite Video with Audio or S-Video with Audio

(Figure 3)

- ➊ Connect a video cable from VIDEO OUT on the VCR back panel to VIDEO INPUT-1, INPUT-2 or INPUT-3 on the TV back panel.
 - ➔ If you have a S-VHS VCR, follow the same steps using the S-Video terminals on the VCR and TV (in place of the composite terminals).
- ➋ Connect a set of audio cables from AUDIO OUT on the VCR back panel to AUDIO INPUT-1, INPUT-2, or INPUT-3 on the TV back panel. The red cable connects to the R (right) channel and the white cable connects to the L (left) channel. If your VCR is mono (non-stereo), connect only the white (left) cable.



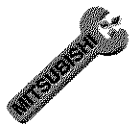

Connecting an Audio Receiver

Connecting an Audio Receiver

Stereo Audio System

(Figure 1)

- 1 Connect the audio cables from AUDIO MONITOR OUTPUT on the TV back panel to TV IN or AUX IN terminals on the back of the audio system. The red cable connects to the R (right) channel, and the white cable connects to the L (left) channel.
- 2 Turn off the TV's speakers through the *Audio/Video Menu*, page 43.
- 3 Set the audio system's input to the TV or AUX position to hear the TV's audio through your stereo system.

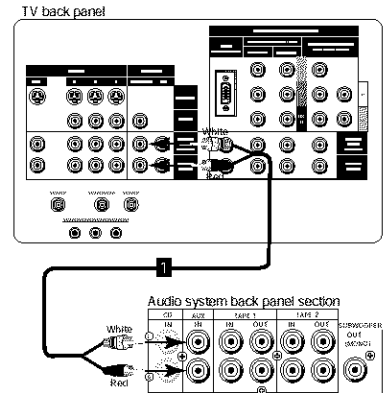

Figure 1. Connecting the Stereo Audio System

IMPORTANT

→ Additional connection cables are not provided with the TV. They should be available at most electronic stores.

A/V Receiver

(Figure 2)

- 1 Connect a video cable or S-Video cable from VIDEO MONITOR OUT on the back of the A/V receiver to VIDEO INPUT-1 on the TV back panel.
- 2 Connect a video cable from VIDEO MONITOR OUTPUT on the TV back panel to VIDEO TV IN on the back of the A/V receiver.
- 3 Connect a set of audio cables from AUDIO MONITOR OUTPUT on the TV back panel to AUDIO TV IN on the back of the A/V receiver. The red cable connects to the R (right) channel, and the white cable connects to the L (left) channel.

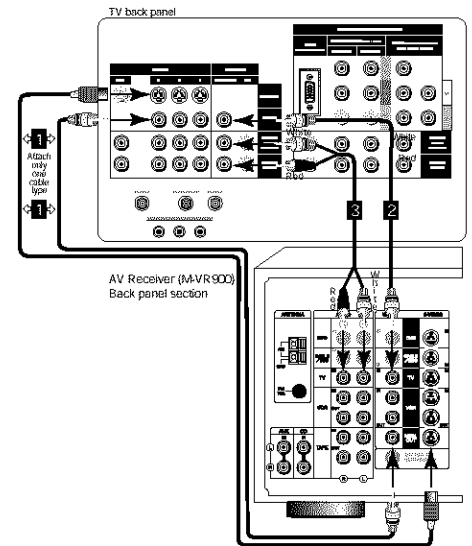

Figure 2. Connecting the A/V Receiver.

IMPORTANT

→ Please see your A/V receiver Owner's Guide for more detailed connections.

WARNING: Do not display the same stationary images on the screen for more than 15% of your total TV viewing in one week. Examples of stationary images are letterbox top/bottom bars from DVD or other video sources, side bars when showing standard TV pictures on widescreen TV's, stock market reports, video game patterns, station logos, web sites, or stationary computer images. Such patterns can unevenly age the picture tubes causing permanent damage to the TV. Please see pages 23 and 58 for a detailed explanation.



Connecting a DVD Player

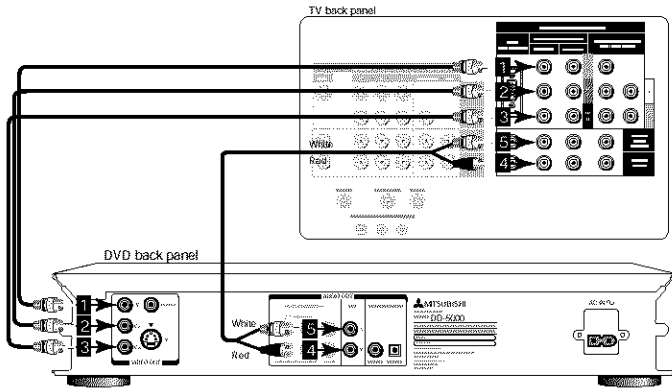

Figure 1. Connecting the DVD player.

IMPORTANT

- See Appendix B, page 61, for component video signal compatibility information.
- For digital audio connections, see your DVD and A/V receiver Owner's Guides.

DVD Player with Component Video (Figure 1)

- Connect the Component Video cables from Y/Cr/Cb or Y/Pr/Pb VIDEO OUT on the back of the DVD player to COMPONENT-1 or COMPONENT-2 on the TV back panel, matching the correct components:

- 1 Y to Y
- 2 Cr or Pr to Pr
- 3 Cb or Pb to Pb

- Connect a set of audio cables from AUDIO OUT on the back of the DVD player to COMPONENT AUDIO Input 1 or 2 on the TV back panel. The red cable 4 connects to the R (right) channel, and the white cable 5 connects to the L (left) channel.

Connecting an S-Video Device

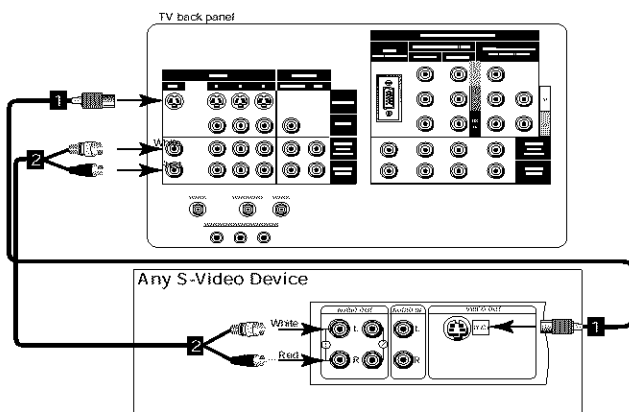

Figure 2. Connecting an S-Video Device.

S-Video Device (Figure 2)

- 1 Connect an S-Video cable from VIDEO OUT on the device back panel to VIDEO INPUT-1, INPUT-2, INPUT-3, or STB on the TV back panel.
- 2 Connect a set of audio cables from AUDIO OUT on the device back panel to AUDIO INPUT-1, INPUT-2, INPUT-3, or STB on the TV back panel. The red cable connects to the R (right) channel and the white cable connects to the L (left) channel. If your device is mono (non-stereo), connect only the white (left) cable.



Connecting a DTV Receiver

DTV Connectors and Adaptors

(Figure 1)

The TV back panel has 5 RCA-type connectors, for the DTV connection. The back panel of your DTV receiver may use RCA-type connectors or BNC-type connectors. If your DTV receiver comes with BNC type connections, you will need to purchase BNC to RCA adaptors to connect the TV to the DTV receiver. These adaptors should be available at most electronic supply stores.

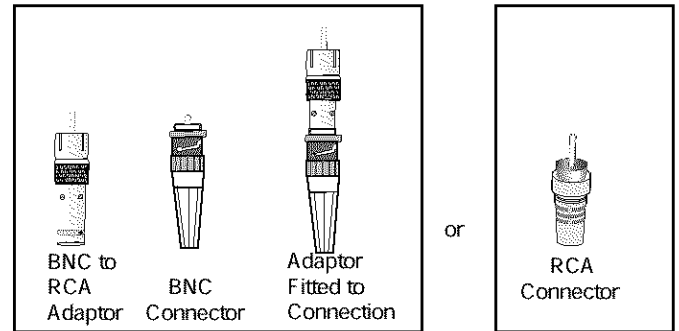

Figure 1. DTV connectors and adaptors.

DTV Receiver with Component Video Connections

(Figure 2)

- 1 Connect the outside antenna, cable, or satellite to ANT, or SATELLITE IN on the DTV receiver (see your DTV receiver's owner's guide for instructions, and cable compatibility).
 - 2 Connect the incoming terrestrial antenna, or cable (not satellite) to ANT-A on the TV back panel (a coaxial splitter, available at most electronic supply stores, may be required to complete this installation).
 - 3 Connect the RCA-type cables from the Y/Pr/Pb outputs on the DTV receiver to HIGH RESOLUTION INPUT Y/Pr/Pb on the TV back panel. You may need to set the DTV input assignment to YPrPb in the *Assign Input menu*, page 33.
 - 4 Connect the L (left) and R (right) audio cables from the DTV receiver to DTV AUDIO on the TV back panel.
- ➔ To utilize the benefits of a digital A/V receiver, connect your DTV receiver's digital audio out to a digital input on your digital A/V receiver.

IMPORTANT

- ➔ See Appendix B, page 61, for component video signal compatibility information.
- ➔ For digital audio connections, see your DTV receiver and A/V receiver Owner's Guides.

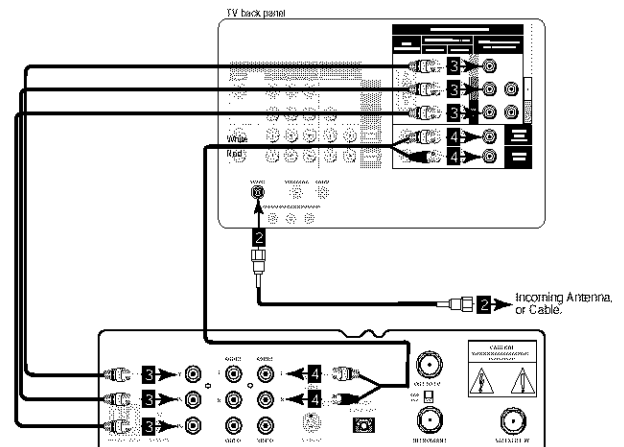

Figure 2. Connecting the DTV receiver with component video connections.

Connecting a DTV Receiver



IMPORTANT

- See Appendix B, page 61, for RGB video signal compatibility information.
- For digital audio connections, see your DTV receiver and A/V receiver Owner's Guides.

DTV Receiver with RGB Video Connections

(Figure 1)

- 1 Connect the outside antenna, cable, or satellite to ANT, or SATELLITE IN on the DTV receiver (see your DTV receiver's owner's guide for instructions, and cable compatibility).
- 2 Connect the incoming terrestrial antenna, or cable (not satellite) to ANT-A on the TV back panel (a coaxial splitter, available at most electronic supply stores, may be required to complete this installation).
- ➔ Connect the RGB cables from the DTV receiver to the HIGH RESOLUTION INPUT GRBHV on the TV back panel. You may need to set the DTV input assignment to RGB in the *Assign Input menu*, page 33.

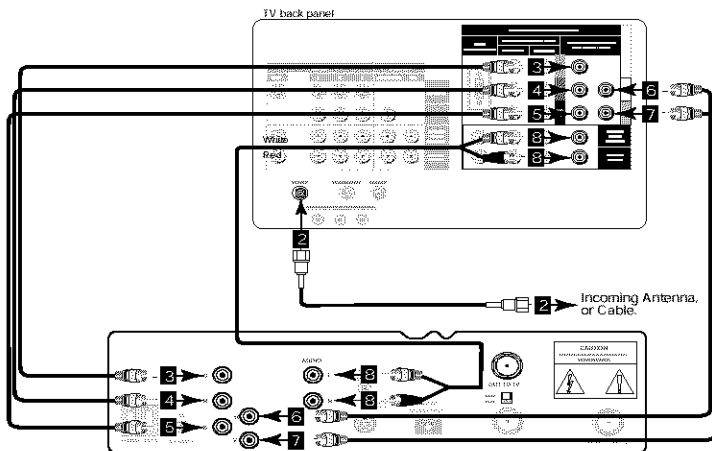

Figure 1. Connecting the DTV receiver with RGB video connections.

DTV Receiver	=	TV Back Panel
3 G (green)	=	Y/G
4 R (red)	=	Pr/R
5 B (blue)	=	Pb/B

- ➔ If the DTV receiver has outputs for H and V sync, connect as listed below (**DO NOT** connect if DTV receiver uses "Sync on Green"):

6 H (horizontal sync)	=	H
7 V (vertical sync)	=	V

- 8 Connect the L (left) and R (right) audio cables from the DTV receiver and to DTV AUDIO on the TV back panel.
- ➔ To utilize the benefits of a digital A/V receiver, connect your DTV receiver's digital audio out to a digital input on your digital A/V receiver.

Connecting a Computer with a VGA Monitor Output

Connecting a Computer

(Figure 1)

- 1 Connect VGA Monitor Out from the computer to VGA on the TV back panel using a VGA compatible monitor cable. See *Appendix B*, page 61, for VGA signal compatibility.
- 2 Connect the L (left) and R (right) audio cables from the computer to VGA AUDIO on the TV back panel. In cases where your computer's audio output is a single mini-RCA jack, a splitter is needed to complete this connection.
- To utilize the benefits of a digital A/V receiver, connect your computer's digital audio out, if available, to a digital input on your digital A/V receiver.

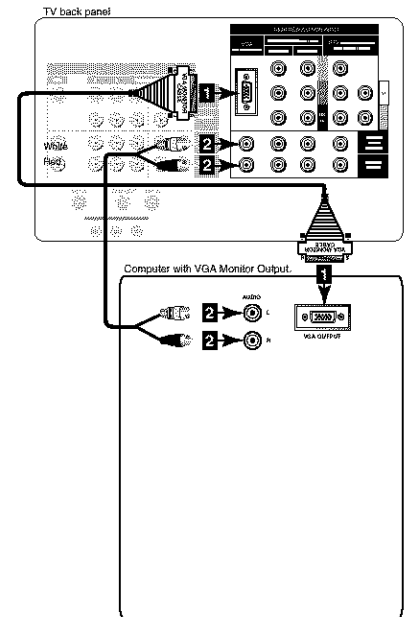

Figure 1. Connecting a computer with a VGA monitor output.

Connecting the System 4 Home Theater IR Control

(Figure 1)

- 1 Connect the IR emitter to IR EMITTER HOME THEATER on the TV back panel.
- 2 Place the IR emitter cable under or along the side of the A/V device. Place the IR lens directly in front of the A/V device's infrared signal receiver. Infrared signal receivers are usually behind the front translucent panel of the device.
- 3 Place unused transmitters in an out-of-the-way location.
- 4 For permanent installation of the IR emitter cable, use the included adhesive tape to secure the bottom of the emitter to the anchoring object of your choice.

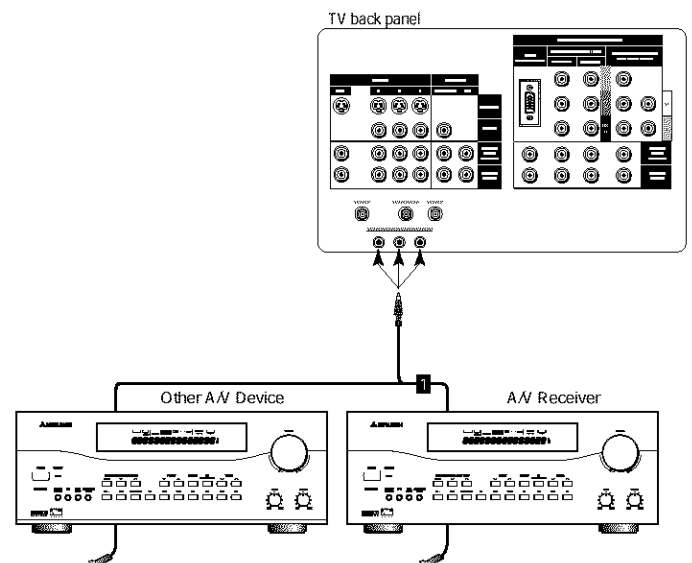

Figure 2. Connecting the System 4 Home Theater IR Control.

IMPORTANT

➔ See page 53 for details on using the TV's IR emitter to control a Mitsubishi A/V receiver.



Warning: Do not leave stationary, toolbar, or partial images on-screen for extended periods of time. Mix the types of pictures shown. Uneven picture tube aging is NOT covered by your warranty.

The VGA capability of this television is designed for occasional use ONLY.

It is not meant to be used as a work station or to view static or odd-shaped images for an extended period of time. Any device connected to your television via the VGA port, including, but not limited to, personal computer, game system, or digital set-top box, must have its screen saver function activated to prevent damage to the television. We **DO NOT** recommend the use of any external device that does not have a screen saver function with this television.

We recommend that screen saver activation time be set to less than 10 minutes and that when using a device through the VGA port, you use lower brightness and contrast settings. If your computer programs allow, toolbars should be set to hidden mode.

Please remember that most computer programs and video game systems display static images, such as boxes, buttons, toolbars, and games scores that can damage the television if used for extended periods of time, repeatedly, or frequently. The VGA Input will automatically select the "Standard" screen format and fill the screen. No other formats are available with the VGA Input. Standard television overscan is used, so VGA images will be cropped on all sides. Resizing of some displays may be required. Consult your owner's manual for computers, computer programs and game systems for assistance with resizing display images. Please see page 58 for an explanation of uneven picture aging.

We're proud of the many advances in digital television, in which we have played a major role. Digital broadcasting brings flawless pictures and sound. At its highest performance level, high definition television (HDTV) delivers images up to six times more detailed than standard analog television.

Smart III

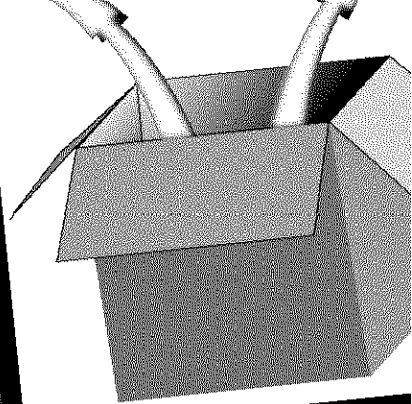

Setup

Programming the Remote Control:	
To Control Other A/V Products	26-27
To Activate the System 4 IR	
Home Theater IR Control	28-29
▶ViewPoint® on-screen menu system	30
Using ▶ViewPoint®	31
Menu Screens (Overview)	31-33
Setup Menu	33
Memorize Channels	33
Assign Input	33
Language	33
Closed Captions Menu	33
Channel Menu	33
V-Chip Lock	36
Advanced Menu	36
Timer	36
Convergence	40
Audio/Video Menu	40
Clock Menu	40
A/V Setting Descriptions	40

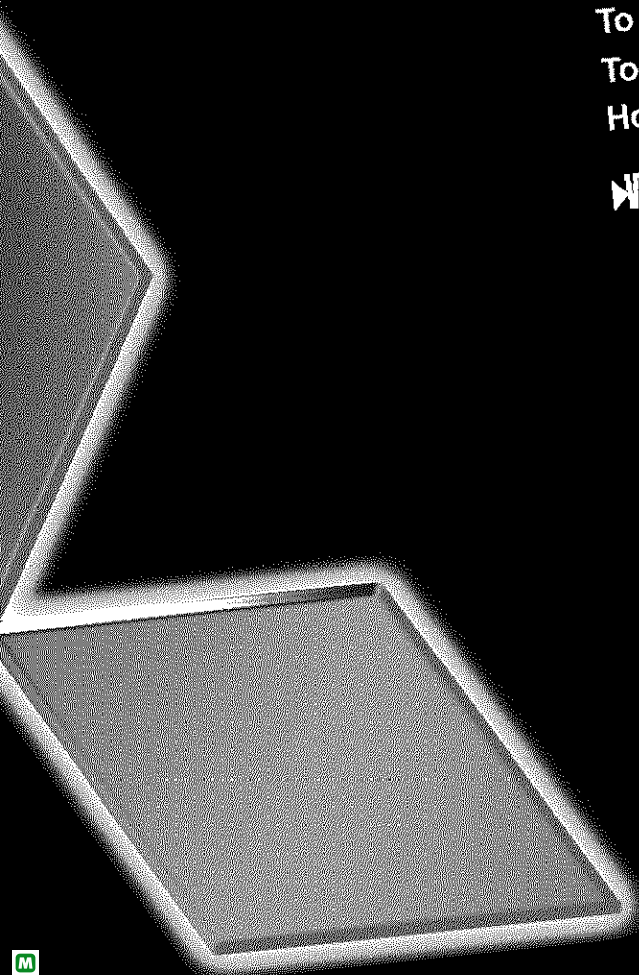

Programming the Remote Control: To Control Other A/V Products

To Program the Remote to Control Other Brands of Audio and Video Products:

(Figures 1-5)

- 1 Move the slide switch at the top of the remote to the product you want to control.
- 2 Press and hold the POWER button on the remote control.
- 3 Enter the first three digit code listed for your equipment, and then release the POWER button on the remote control.
- 4 Point the remote control at the equipment and press the POWER button. If the equipment responds, the remote control is properly programmed to operate the equipment. If the equipment does not respond, repeat steps 2-4 with the next three digit code listed in step 3 for your equipment.

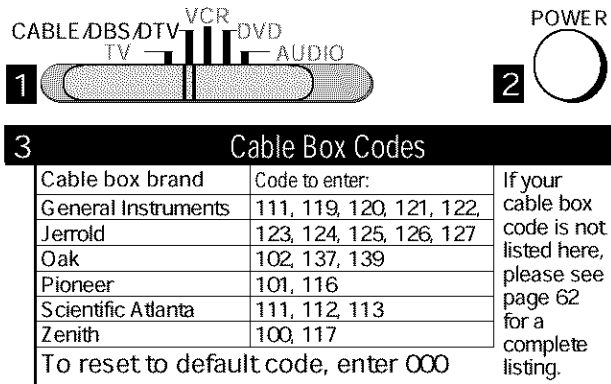

Figure 1. Programming the remote to control your cable box.

IMPORTANT

→ If you cannot turn the cable box ON by pressing POWER, try pressing CHANNEL or the number buttons.

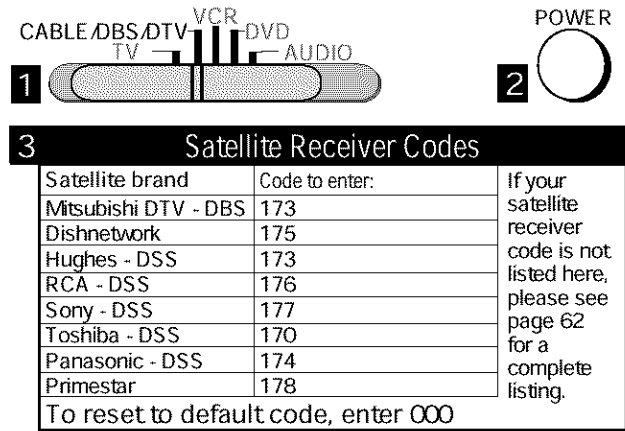

Figure 2. Programming the remote to control your satellite receiver.

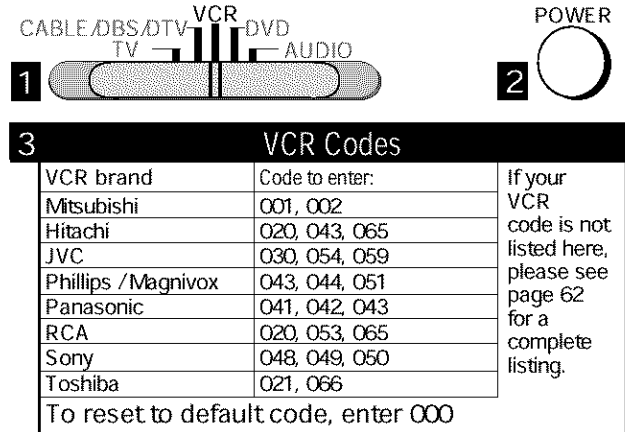

Figure 3. Programming the remote to control your VCR.

IMPORTANT

→ When set to TV, the PLAY, STOP, REW/REV, and FF/FWD buttons will operate the VCR after a VCR code has been properly programmed into the remote control.

Programming the Remote Control: To Control Other A/V Products



3 DVD/LDP Player Codes		
DVD/LDP brand	Code to enter:	If your DVD code is not listed here, please see page 62 for a complete listing.
Mitsubishi (DVD)	003	
Mitsubishi (LDP)	016, 017	
Panasonic	250	
Pioneer DVD (LDP)	252 (016, 017)	
Sony	254	
Toshiba	253	
To reset to default code, enter 000		

Figure 4. Programming the remote to control your DVD/LDP.

After entering the correct codes in each position of the remote control, use the slide switch to select which product will respond when an operational button is pressed. If you enter a code from the AUDIO chart while the slide switch is set to TV, the volume and mute functions change to match the A/V receiver. This is useful when using an A/V receiver with the TV all the time. In all other cases, only one of the below devices is allowed for each slide switch position.

TV position:

- ➡ TV
- ➡ A/V receiver (volume and mute only)

Cable/DBS/DTV position:

- ➡ Cable box
- ➡ Satellite receiver
- ➡ DTV receiver

VCR position:

- ➡ VCR

DVD position:

- ➡ DVD
- ➡ LD Player

Audio position:

- ➡ A/V receiver
- ➡ Mitsubishi CD player [If you have a Mitsubishi A/V receiver, the audio position may be used in conjunction with select Mitsubishi CD players. Your audio position must be programmed to either 010 or 011. Plug the CD player power cord into a switched outlet on the back of your A/V receiver. Pressing the POWER button will then turn on your A/V receiver, in turn, turning on your CD player. On select CD players, the transport controls (FF, Play, Rew, etc.) in the audio position will operate the CD player.]



3 A/V Receiver Codes		
Audio brand	Code to enter:	If your audio code is not listed here, please see page 62 for a complete listing.
Mitsubishi A/V receiver and/or CD player	Set MVR1000 or MVR800 to 015 Set MVR900 or MVR700 to 010	
Denon	234, 235, 236	
Kenwood	200, 208	
JVC	232, 233	
Onkyo	209, 214	
Pioneer	205, 207	
Sony	222	
Yamaha	201, 202	
To reset to default code, enter 000		

Figure 5. Programming the remote to control your A/V receiver.

IMPORTANT

- ➔ If the slide switch is set to TV when you enter an A/V receiver code, VOLUME and MUTE will control the A/V receiver rather than the TV. To return volume and mute control to the TV, set the slide switch to TV, press and hold POWER and enter 000.

IMPORTANT

- ➔ Some manufacturers may change their products, or they may use more than one remote control system. If this is the case, your remote control may not be able to operate your VCR, DVD, cable box, satellite receiver, or A/V receiver.

Programming the Remote Control: To Activate the System 4 Home Theater IR Control

Activation of the System 4 Home Theater IR Control

For select brands of digital A/V receiver's, you can set up the remote control to automatically select the correct audio input when you press the HOME THEATER button. At the same time, the TV will select the correct video input. This allows you to watch your best type of video (Component, S-Video) with your best type of audio (Dolby Digital, Pro Logic, etc.) conveniently. See *System 4 Home Theater IR Control*, page 22, for connection instructions.

Once properly activated, when the HOME THEATER button is pressed, System 4 Operates In 2 Parts:

AUDIO Changes a compatible digital A/V receiver to the correct input for the device you wish to operate.

VIDEO Changes the TV to the correct input for the device you wish to operate.

Both functions can operate simultaneously with one touch of the HOME THEATER button. However, you may activate only one if you desire (video to control the TV or audio to control the A/V Receiver). The remote control must be programmed to the appropriate A/V Receiver code prior to the activation of the audio portion (see *To Program the Remote to Control Other Brands of Audio and Video Products*, page 26).

To Activate the Audio Portion:

(Figure 1)

- 1 Press and hold the HOME THEATER button.
- 2 Press and release the AUDIO button.
- 3 Name the TV input as instructed.



3 Name TV Input as Shown Below (see pg 33 for naming help)

Device You Are Using	Name Input
Cable Box connected to ANT-A or ANT-B	Cannot be named
Cable Box connected to STB	CABLE
Satellite Receiver connected to any input	DBS
Digital TV/Satellite Receiver connected to DTV	Cannot be named
VCR connected to input 1, 2, 3, or 4	VCR
DVD connected to any input but DTV	DVD

Figure 1. Activating the audio portion of System 4 for the CABLE/DBS/DTV layer.

To Activate the Video Portion:

- 1 Press and hold the HOME THEATER button.
- 2 Press and release the VIDEO button.

Programming the Remote Control: To Activate the System 4 Home Theater IR Control

Testing System 4 for Proper Setup

- 1 Move the slide switch to the position you wish to test.
- 2 Point the remote at the TV.
- 3 Press and release the HOME THEATER button. If the audio portion has been properly setup, your A/V receiver will have changed to the appropriate input as indicated in table 1, page 15. If the video connection of your System 4 has been properly setup, your TV will have changed to the appropriate input.

AUDIO If the A/V Receiver did not change inputs...

- 1 Repeat *Special Setups*, page 15, and retest.
 - 2 Reposition IR emitter(s) and retest
 - 3 Repeat *To Activate the Audio Portion*, page 28, and retest.
- ➔ If your A/V receiver is still not responding to the commands from your remote control, you may have an incompatible A/V receiver. Proceed to *Deactivating the System 4 Home Theater IR Control*, on this page.

IMPORTANT

- ➔ System 4 is designed for use with A/V receivers that have at least 4 inputs. A/V receivers with fewer may be only partially compatible.

VIDEO If the TV did not change inputs...

- 1 Repeat *To Activate the Video Portion*, page 28, and retest.

Deactivating the System 4 Home Theater IR Control

- 1 Simultaneously press the CANCEL button and the HOME THEATER button.
- 2 Repeat *To Activate the Video Portion*, page 28.

AUDIO If the A/V Receiver changed to an input other than the one indicated in table 1, page 15...

- 1 Connect the audio output from your A/V device to the A/V receiver input that your A/V receiver DID change to, and retest.

The 3D Graphical ViewPoint® Menu System

Your TV has Mitsubishi's exclusive 3D Graphical ViewPoint® on-screen operating system, which provides on-screen information for menu choices and changes (Figure 1).

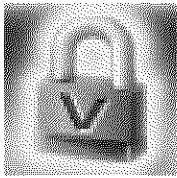

A picture (icon) will be highlighted when selected with the ADJUST arrows. When selected, the appropriate menu will appear. You may then make changes within the menu or access sub-menus, if available.

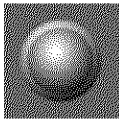

A button indicates that you will access a sub-menu or start an automatic function by making this selection.

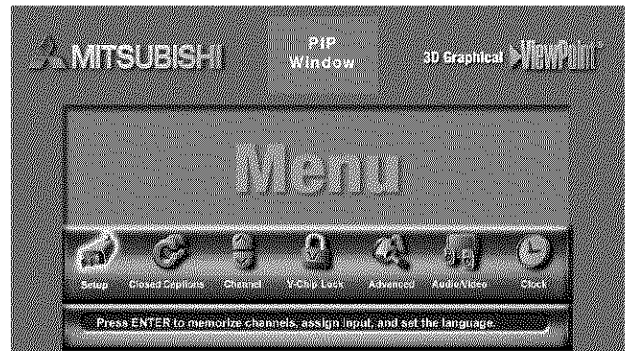

Figure 1. Main Menu: The Main Menu screen will always be the first screen that appears when you press the MENU button.

The ViewPoint® system includes the following special features:

- The currently selected icon or button is highlighted with a yellow outline and the text color will be yellow.
- On-screen instructions provide complete menu choice information.
- Some on-screen menu options must be set before other options are available. For example, "Set the Timer" will only be possible if "Clock Time" and "Set Day" have been set.

The following buttons on your remote control will help you to navigate within the ViewPoint® system (Figure 2):

- 1 ADJUST ▶ to select the menu item you want to change.
- 2 ADJUST ▲ or ▼ to change the settings.
- 3 ENTER to enter into a menu, start an automatic function, or select a checkbox.
- 4 CANCEL to clear a setting, or stop an automatic function.
- 5 MENU to move back one menu screen at a time.
- 6 HOME to exit all menus and return to TV viewing.

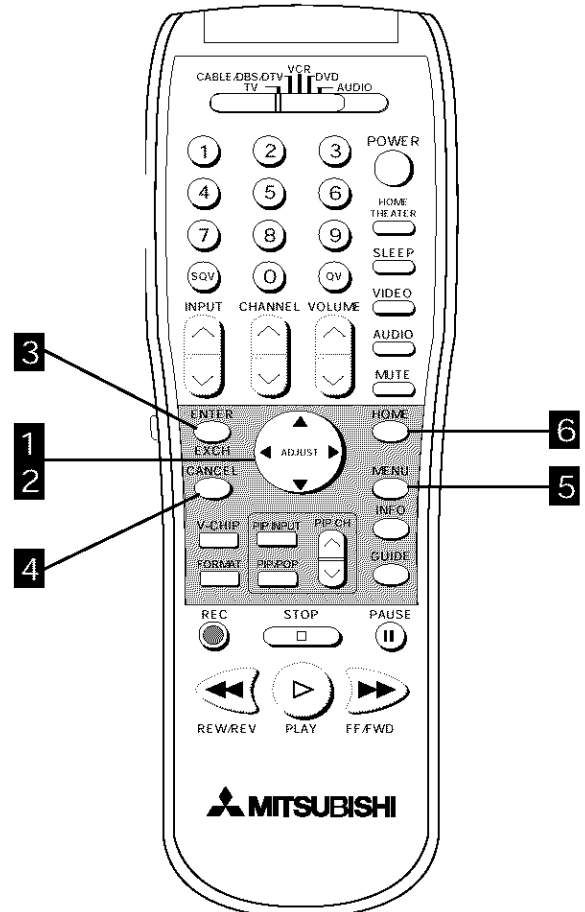

Figure 2. These buttons are used for navigation within the ViewPoint® on-screen operating system.

Menu Screens (Overview)



Figure 1. Setup menu

Setup Menu

(Figure 1)

You can put channels in memory, turn on or off input connections of the TV, and select the menu system to display in English or Español (Spanish).

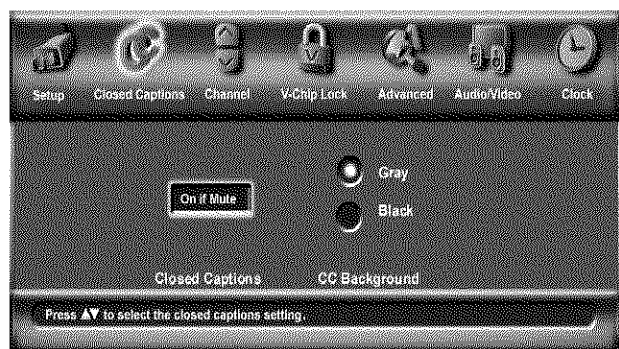

Figure 2. Captions menu

Captions Menu

(Figure 2)

Display captions or text, and choose black or gray as the background color for the closed caption area.

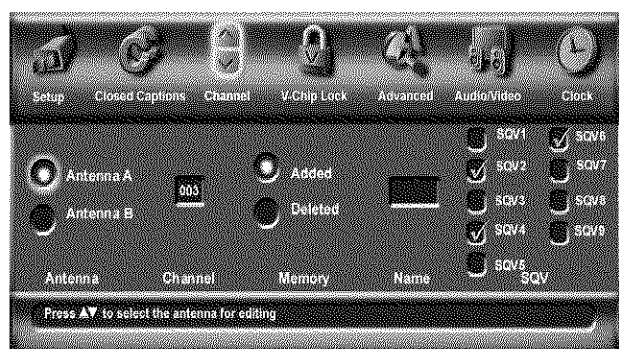
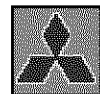

Figure 3. Channel menu

Channel Menu

(Figure 3)

Use to customize the channel information for Ant-A and Ant-B. Manually add or delete channels from memory, name channels for Ant-A and Ant-B, or add your favorite channels to a SQV (Super Quick View™) list.



Menu Screens (Overview)

V-Chip Lock Menu

(Figure 1)

Block or allow programming based upon rating signals sent by the broadcast station, or by time.

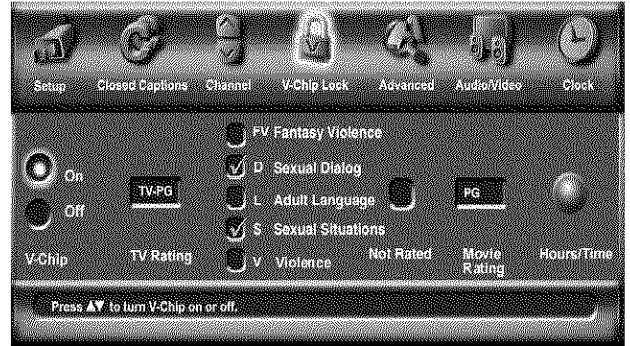

Figure 1. V-Chip Lock menu

Advanced Menu

(Figure 2)

Set your TV to turn on automatically, converge (align) the three main colors, display a blue screen when viewing an input with no signal, enhance the darker parts of bright pictures, and change the line doubling method.

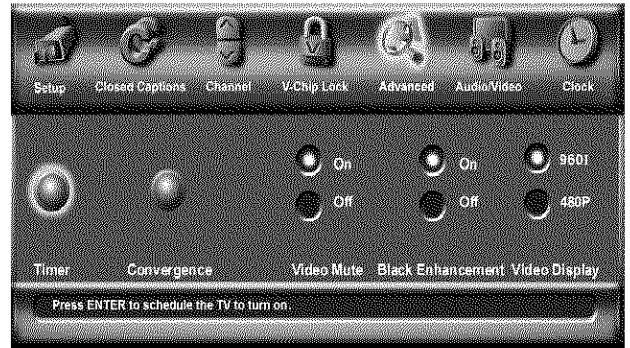

Figure 2. Advanced menu

Audio/Video Menu

(Figure 3)

A/V Reset on the menu allows you to return the A/V settings for the current input to the factory presets. A/V Reset on the front panel resets all inputs at one time. You can also adjust some or all of the A/V settings, (each input can be set to your preferences), turn the TV speakers on or off, and choose how you want to control the TV's audio output.

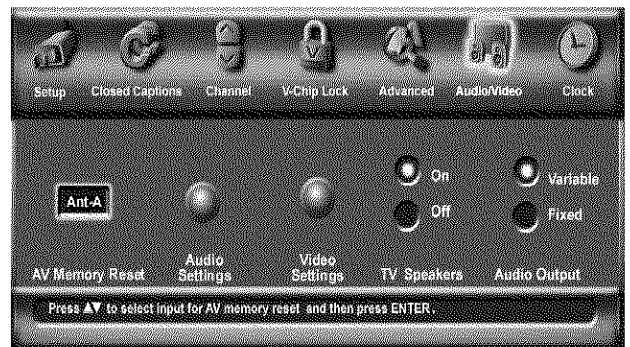

Figure 3. Audio/Video menu

Clock Menu

(Figure 4)

Manually set the time for the TV, or select Auto and the TV will automatically set the time based upon Extended Data Service (XDS) time data. This time data is usually broadcast by your local PBS station.

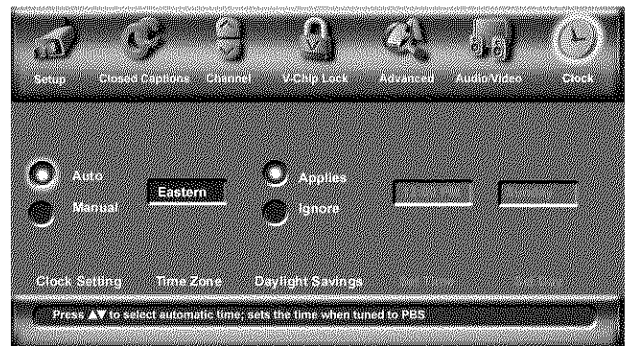

Figure 4. Clock menu



Setup Menu: Memorize Channels, Assign Input, and Language

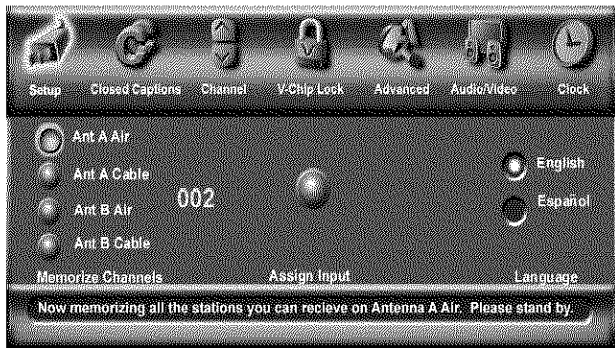

Figure 1. Memorize Channels

Memorize Channels

(Figure 1)

This selection memorizes the channels your TV can receive and skips the unused or weak channels. You can stop memorization at any time by pressing CANCEL. Channels memorized prior to pressing CANCEL will stay in memory. After channels are memorized, you may select memorized channels in ascending or descending order by pressing the CHANNEL button on the remote control.

IMPORTANT

→ **DTV Note:** If you have a DTV receiver connected, you will need to use that receiver's channel memorization system to memorize digital channels.

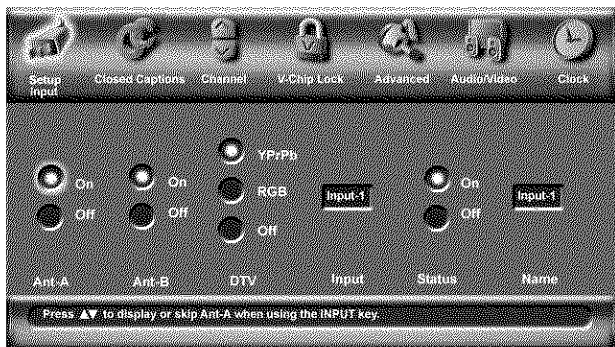

Figure 2. Assign Input menu

Assign Input Menu

(Figure 2)

Assign Input turns off unused inputs, turns them on again, or changes the name of the input. If you turn an input Off, it will be skipped when you press the INPUT button on the remote control. Your choices are:

- ➡ Ant-A, and Ant-B: On or Off.
- ➡ DTV: YPrPb, RGB, or Off.
- ➡ Input: Cycle through the available inputs (Inputs 1-4, Component inputs 1-2, STB, and VGA).
- ➡ Status: Turn the selected input On or Off.
- ➡ Name: Name the selected input (VGA input cannot be named).

Language

(Figure 3)

Display the on-screen menus in either English or Spanish (Español). The first time your TV was powered on, you were requested to select an on-screen menu language. You may change your selection by pressing the ADJUST ▲ or ▼ button on the remote control.

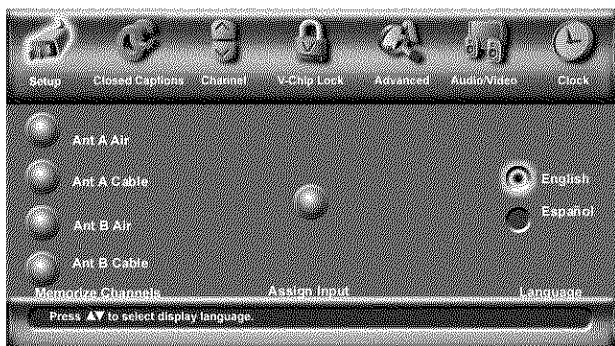
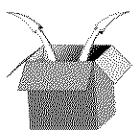

Figure 3. Language



Captions Menu: Closed Captions

Captions Menu

(Figure 1)

Broadcasters can send either Standard or Text closed captioning. Standard closed captioning follows the dialogue of the characters on-screen and displays in a small section of the screen. Text closed captioning often contains information such as weather or news and covers a large portion of the on-screen program. Your TV can decode four different standard and four different text closed captioning signals from each TV station. However, each TV station may broadcast only one or two closed captioning signals, or none at all.

Within the Captions menu, you can turn on or off the closed caption decoder, select the type of captions or text, and choose black or translucent gray as the background color for the closed caption area.

Closed Captions

(Figure 1)

The TV can display one of the following:

- CC1, CC2, CC3, or CC4: Standard closed captioning signals.
- Text1, Text2, Text3, or Text4: Text closed captioning signals.
- On if mute: Closed captions when mute. When selected, the standard closed captioning signal (CC1) will turn on/off by pressing the MUTE button on the TV remote control.
- Off: No closed captions.

CC Background

(Figure 1)

To make the closed captions easier to read, you can choose to display the background color as either black or translucent gray.

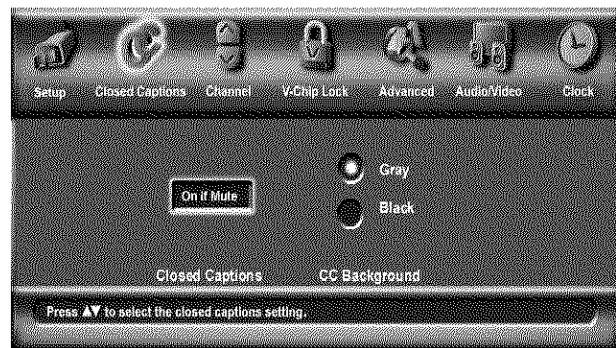

Figure 1. Captions menu

IMPORTANT

- ➔ When Text closed captioning is selected, a large black or gray box will appear on your TV screen if no signal is broadcast.

IMPORTANT

- ➔ The content of captions is determined by the broadcaster. If your captions show strange characters, misspellings, or odd grammar, it is not a malfunction of the TV.

Channel Menu: Antenna, Channel, Memory, Name, and SQV™



Figure 1. Channel menu

Antenna

(Figure 1)

Select Ant-A, or Ant-B. For each antenna, you can add or delete channels in memory, name channels, and add channels to the SQV (Super Quick View™) list.

Channel

(Figure 1)

Select the channel you want to add or delete from memory, name, or add to the SQV Super Quick View™ list.

Memory

(Figure 1)

After all available channels have been memorized with *Memorize Channels*, page 33, weaker channels viewed with Ant-A or Ant-B can be added and unwanted channels can be deleted.

Use the CHANNEL button on the remote control to view memorized channels.

Name

(Figure 1)

Channels shown on Ant-A or Ant-B can be given names (up to four characters). After you enter a name, it will appear on the TV screen, next to the channel number.

SQV (Super Quick View™)

Using The Menu Screen

(Figure 1)

SQV (Super Quick View™) allows you to put together a list of your favorite channels from Ant-A and Ant-B. You can store up to 6 channels in each of the 9 different memory banks. Once you have added a channel to the SQV memory, “SQV” will appear under the channel number on the TV screen.

SQV (Super Quick View™)

Using The Remote Control

Viewing and changing SQV banks using the remote control:

- 1 Press the SQV button.
- 2 To change memory banks, press a number button within 5 seconds of pressing the SQV button.
- 3 Press the SQV button repeatedly to cycle through the channels available in that bank.

Adding SQV channels using the remote control:

- 1 Use the CHANNEL or number buttons to select the channel you want to add to the current SQV memory bank.
- 2 Press and hold the SQV button for about 3 seconds. When “SQV” and the memory bank number appear under the channel number, the channel has successfully been added.

Removing SQV channels using the remote control:

- 1 Press the SQV button repeatedly until you see the desired channel.
- 2 While the channel number and SQV indicator are still displayed on the screen, press the CANCEL button. If the CANCEL button is not pressed before the SQV indicator disappears, the channel will not be removed.
- 3 When the SQV indicator disappears, the channel has successfully been removed.

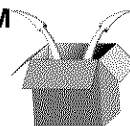

V-Chip Menu: V-Chip Lock

V-Chip Lock

(Figure 1)

The V-Chip Lock allows you to Block or Allow programs based upon rating signals sent by the broadcasting station. The TV comes from the factory with the V-Chip lock in the Off setting. You can turn the lock On within the V-Chip Menu. The factory preset is TV-PG, allowing only programs rated TV-PG or lower. You can change the blocking level to various TV or movie ratings, lettered categories, and by time. After changing channels or inputs, there may be up to a 5 second delay before the V-Chip lock takes effect. The V-CHIP button on the remote control enables you to conveniently turn the lock on or off.

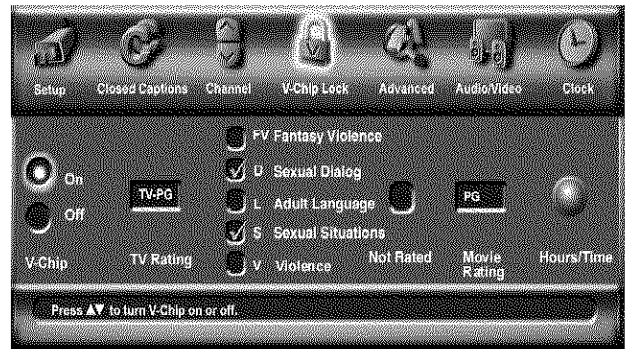

Figure 1. V-Chip Lock menu

Entry to the V-Chip Lock

(Figures 2 & 3)

The first time you select V-Chip Lock from the MAIN menu, or after you have canceled your passcode you will see the screen shown in Figure 2. Use the number buttons on the remote control to input a four-digit passcode, then press ENTER. You can delete a character and move back one space by pressing CANCEL. You can exit without inputting a passcode by pressing MENU or HOME. The next time you select V-Chip Lock from the MAIN menu, you will see a menu screen similar to the one in Figure 3.

IMPORTANT

→ If you forget your four-digit passcode, see Appendix A, page 59.

V-CHIP LOCK

To go to the menu,
enter a new passcode.

Use the NUMBER buttons,
then press ENTER.

Figure 2. V-Chip Lock passcode screen (first-time entry)

V-CHIP LOCK

To go to the menu,
enter your passcode.

Use the NUMBER buttons,
then press ENTER.

Figure 3. V-Chip Lock passcode screen (re-entry)

V-Chip Menu: V-ChipLock

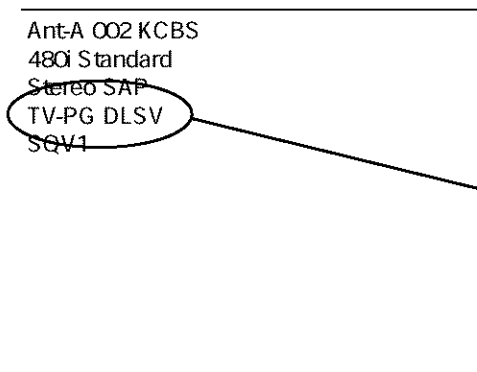

V-Chip Signal Information

(Figure 1)

When provided by the broadcaster, V-Chip signal information can be displayed by pressing the INFO button on the remote control. Rating guidelines are provided by broadcast stations. TV programs and made-for-TV movies can be blocked by the TV Rating and/or Categories signal. Made-for-theater and direct-to-video movies can be blocked by the Movie Rating signal.

Figure 1. V-Chip signal information.

IMPORTANT

→ If no V-Chip rating and/or category signal is sent from the broadcaster, no rating information will be displayed, and the V-Chip Lock will not be able to block the program or movie.

TV Ratings and Descriptions	TV-Y Youth	TV-Y7 Youth 7+ Years	TV-G General Audience	TV-PG Parental Guidance	TV-14 14+ Years	TV-MA Mature Audience
--------------------------------	---------------	----------------------------	-----------------------------	-------------------------------	--------------------	-----------------------------

Table 1. V-Chip rating information that may be included with TV programs and made-for-TV movies. If you set the lock to TV-G; TV-Y, TV-Y7, and TV-G will be available, and TV-PG, TV-14, and TV-MA will be blocked.

TV Categories and Descriptions	Program Not Rated	FV Fantasy Violence	D Sexual Dialog	L Adult Language	S Sexual Situations	V Violence
-----------------------------------	----------------------	---------------------------	-----------------------	------------------------	---------------------------	---------------

Table 2. V-Chip category information that may be included with TV programs and made-for-TV movies. If you set the category L to be blocked; all programming carrying the L signal will be blocked (regardless of its TV rating).

Movie Ratings and Descriptions	OFF V-Chip is off	G General Audience	PG Parental Guidance	PG-13 13+ Years	R Restricted	NC-17 18+ Years	X Adult
-----------------------------------	-------------------------	--------------------------	----------------------------	--------------------	-----------------	--------------------	------------

Table 3. V-Chip rating information that may be included with made-for-theater and direct-to-video movies. If you set the lock for PG-13; G, PG, and PG-13 will be available, and R, NC-17, and X will be blocked.

IMPORTANT

→ Video tapes, laser discs, and DVD's may not contain the special V-Chip rating signals. If this occurs, the V-Chip Lock will not be able to block the program or movie.

IMPORTANT

→ "Programs Not Rated" is a V-Chip category that applies to broadcasted programming such as news, weather, or emergency programs. Please use care when blocking this category.

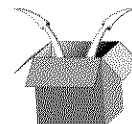

V-Chip Menu: V-Chip Lock Hours/Time

V-Chip Lock Hours/Time

(Figure 1)

V-CHIP HOURS/LOCK BY TIME will allow you to activate the V-Chip or lock the entire TV during speci chour s

V-Chip Start Time and V-Chip Stop Time

(Figure 1)

Select the times you would like the V-Chip to be Active. By setting the V-Chip Start Time and V-Chip Stop Time to the same time, the V-Chip will be active 24 hours a day.

Press ▲ or ▼ to slowly adjust the time. Press and hold ▲ or ▼ to quickly adjust the time.

Lock by Time, Lock Time, and Unlock Time

(Figure 1)

Lock by Time locks the entire TV based upon the Lock Time and Unlock Time. You must input your 4-digit passcode to use the TV when it is locked. By setting the Lock Time and Unlock Time to the same time, the Lock by Time will be active 24 hours a day.

Passcode Screen

(Figure 2)

To view a V-Chip blocked program or to watch the TV during a scheduled lock time, you must enter your 4-digit passcode. The V-Chip block and Lock by Time will remain disabled until the TV is powered off and then on again.

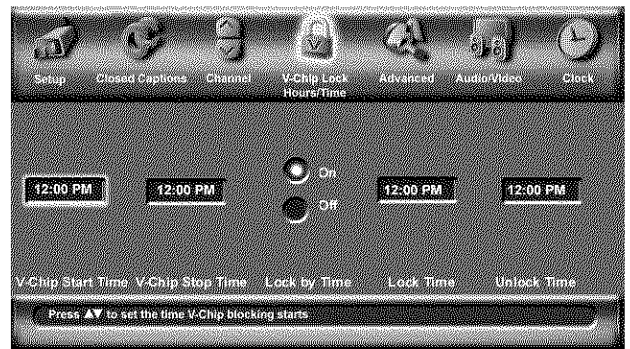

Figure 1. V-Chip Hours/Lock by Time menu

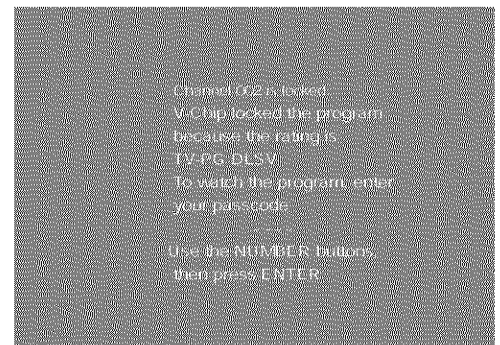

Figure 2. Passcode Screen

Advanced Menu: Timer

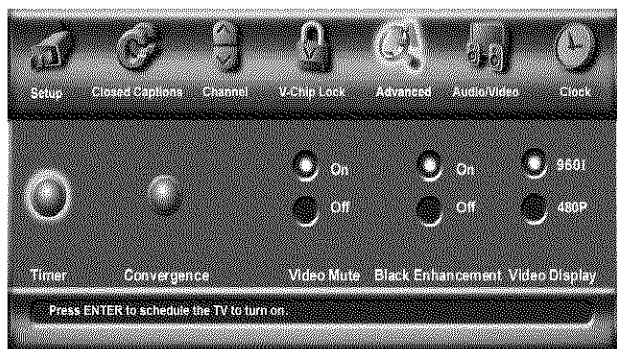

Figure 1. Timer selection in the Advanced menu

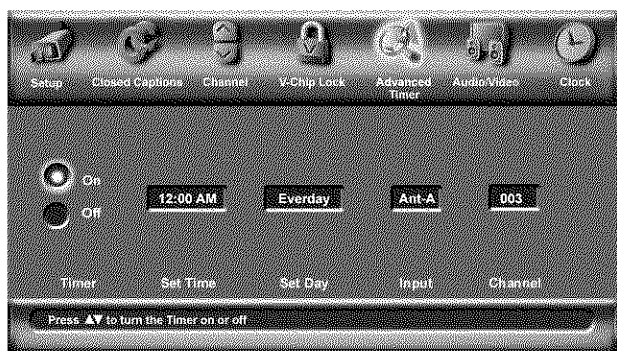

Figure 2. Timer menu

Timer Menu

(Figure 2)

The timer can be turned On or Off. When On, you need to select the time to turn on, the day to turn on, and the channel to display. At your preselected time, the timer will turn the TV on, and a message will be displayed, “Press a key for the TV to stay on”. Any button on the remote control must be pressed within 5 minutes, or the TV will turn itself off.

Set Time

Select the hour and minute, including AM or PM, when the TV is to turn on.

Press ▲ or ▼ to slowly adjust the time. Press and hold ▲ or ▼ to quickly adjust the time.

Timer

(Figure 1)

The timer will automatically turn the TV on (if it is off) at the time you schedule and select.

IMPORTANT

- The TV's clock must be set before you can set the timer. If you have not set the clock and/or day, you will see the CLOCK menu instead of the Timer menu.

Set Day

Select the days that the TV will turn on automatically. You can select Everyday, Mon-Fri (Monday through Friday), or the individual days of the week.

Input

Select the input to use when the timer turns on the TV. If the TV is already on, the timer will turn the TV to this selected input.

Channel

When Ant-A or Ant-B is the selected input, you may select any memorized channel. The TV will tune to this channel when the timer turns it on.

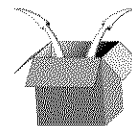

Advanced Menu: Convergence

Convergence

(Figure 1)

Your Mitsubishi TV has three picture tubes which are aligned to properly converge the projected light beams on the screen. Each picture tube projects a single color of red, blue or green. During production, your TV was carefully adjusted to properly align these colors. As a special feature, you have the ability to adjust the red and blue light beams in reference to the red green light beam. This process is called convergence.

Convergence Menu

(Figure 2)

Convergence aligns the entire screen at once. Select either Red Convergence or Blue Convergence to begin alignment. To align 64 individual points, see *Advanced Convergence*, page 41.

Reset Factory Defaults

(Figure 2)

This allows you to reset the convergence to the factory settings. The message "Convergence completed" will be displayed when the factory defaults have been restored.

Convergence Screen

(Figure 3)

When the Red and Blue crosshairs are properly converged, the center-screen crosshairs will appear white. You can use ▲, ▼, ◀, or ▶ to move the Red and Blue crosshairs. Press VIDEO to switch between Red and Blue. Press AUDIO for the Advanced Convergence screen, and see *Advanced Convergence*, page 41, for instructions.

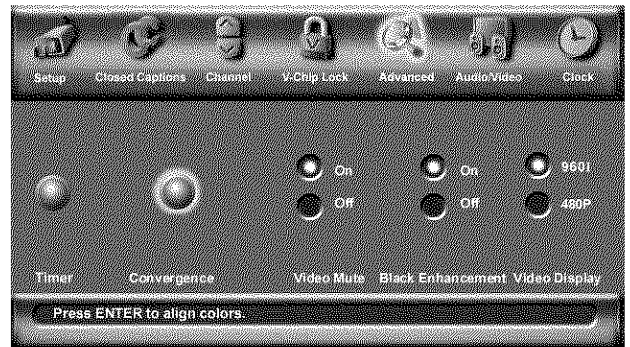

Figure 1. Convergence selection in the Advanced menu

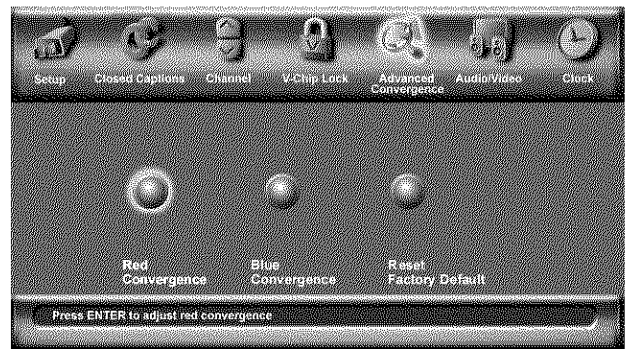

Figure 2. Convergence menu

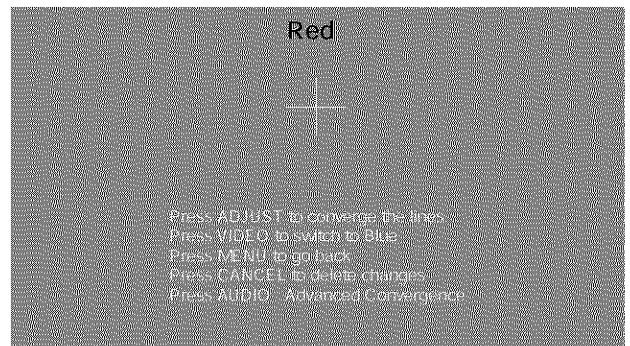

Figure 3. Convergence screen

Advanced Menu: Advanced Convergence, Video Display, and Video Mute

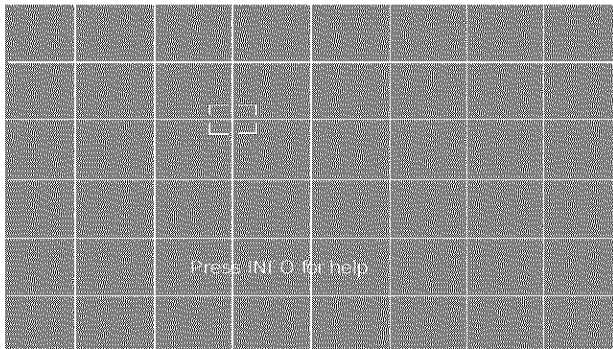
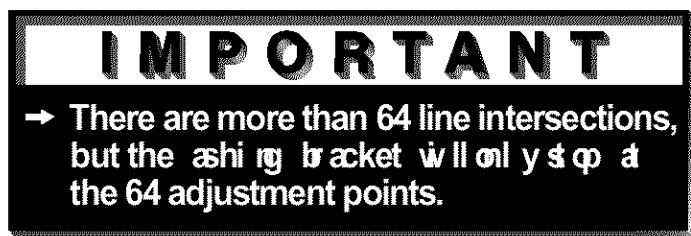

Figure 1. Advanced Convergence screen



Advanced Convergence

(Figure 1)

After adjusting the Red Convergence and Blue Convergence, you can re-tune your TV by adjusting the Red and Blue convergence at 64 individual points. Move the white bracket to a position needing adjustment by pressing ▲, ▼, ◀, or ▶. Press ENTER to select the position (white will stop). Move the Red or Blue line by pressing ▲, ▼, ◀, or ▶. Press VIDEO to switch between the Red and Blue lines. A position is properly converged when all three lines combine to appear white. Press ENTER to deselect the position (white will resume), and move the brackets to the next position needing adjustment. When completed, press MENU to save your changes, and exit the Advanced Convergence screen.

Video Mute

(Figure 2)

Video Mute lets you display a blue or gray background when no signal is being received on inputs 1-4, and STB.

Black Enhancement

(Figure 2)

The contrast in dark scenes is enhanced for better picture quality. Brighter scenes will not be affected.

Video Display

(Figure 2)

Your Mitsubishi TV will double the lines of a standard 480i (interlaced) picture to produce a smoother, more like image. You have two choices for your selection; 480p or 960i. The 480p display may be more stable (although may still show some line structure). The 960i display may hide the line structure (although picture movement may be visible in still images).

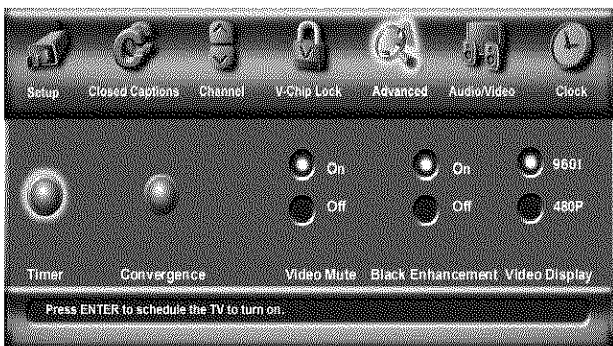
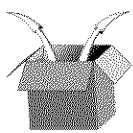

Figure 2. Advanced menu





Audio/Video Menu: AV Memory Reset, and Audio/Video Settings

AUDIO/VIDEO SETTINGS menu

(Figure 1)

Each of the 11 inputs has its own A/V memory. You can adjust each input's A/V memory in two ways. You can use the menu, or the remote control.

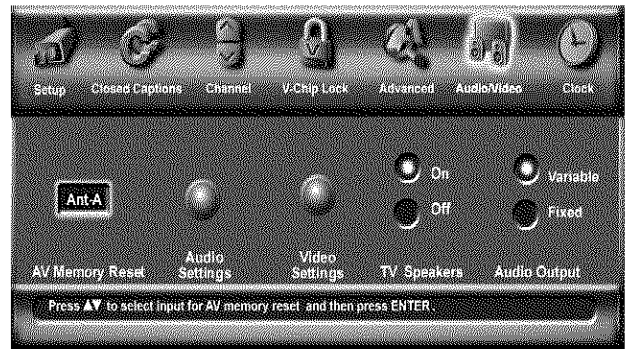

Figure 1. Audio/Video menu

A/V Memory Reset

A/V Memory Reset will return the currently selected input's A/V memory to the factory settings. To reset an input's A/V memory, move to A/V Memory Reset, select the input you want to reset, and press ENTER.

AUDIO SETTINGS and VIDEO SETTINGS

After selecting AUDIO SETTINGS or VIDEO SETTINGS, you can adjust the settings by pressing ▲, ▼, ◀, or ▶. For descriptions of the individual A/V settings see *A/V Setting Descriptions*, pages 46-47.

Using the AUDIO and VIDEO Buttons on the Remote Control

(Figure 2)

- 1 Press AUDIO or VIDEO to cycle through the available settings.
- 2 Press ◀ or ▶ to adjust the setting. After 5 seconds of inactivity, the setting display will disappear.

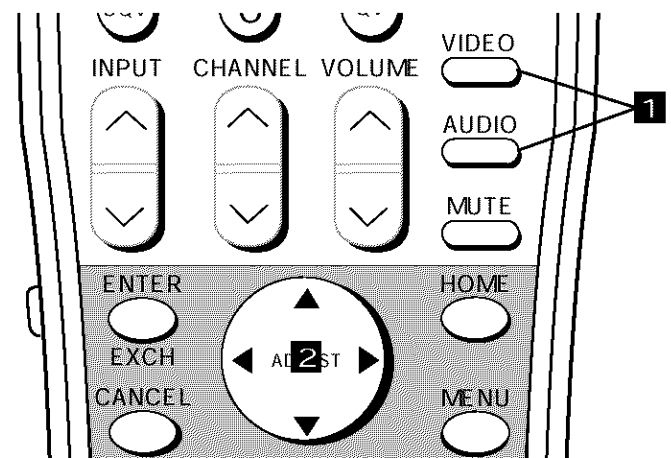

Figure 2. The AUDIO, VIDEO, and ADJUST buttons.

AV Memory Reset, and Audio/Video Settings

Audio/Video Menu: TV Speakers, and Audio Output

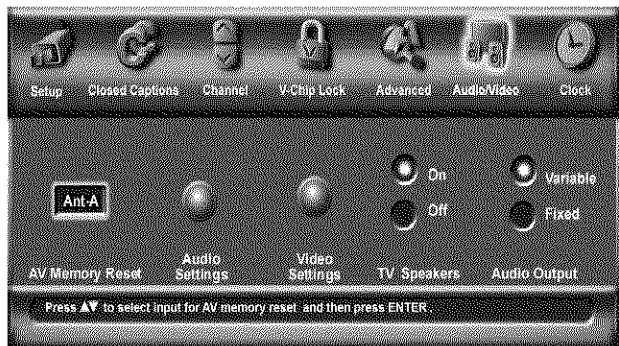
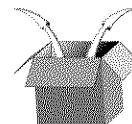

Figure 1. Audio/Video menu

TV Speakers

(Figure 1)

This selection will turn on or off the TV's internal speakers. You may select Off when sending the sound through a separate stereo system or surround sound A/V receiver.

IMPORTANT

→ To prevent damage from a sudden increase in volume, make sure the TV volume is low before choosing ON.

Audio Output

(Figure 1)

Select Fixed if your audio receiver or stereo system can be controlled with a remote. This allows you to adjust the volume with the system's remote control or the TV remote control, if compatible. This setting is better for surround sound receivers. Select Variable if your audio receiver or stereo system cannot be controlled with a remote. This allows the TV's internal circuitry to adjust the volume.



Clock Menu: Clock Setting (Manual)

Clock Setting (Manual)

(Figure 1)

For the manual clock setting, select the current time, including AM or PM.

Press ▲ or ▼ to slowly adjust the time. Press and hold ▲ or ▼ to quickly adjust the time.



Figure 1. Clock menu (Manual)

Set Day

(Figure 1)

When Manual has been selected for the Clock Setting, you need to select the current day of the week.



Clock Setting (Manual)

Clock Menu: Clock Setting (Auto)



Figure 1. Clock menu (Auto)

Clock Setting (Auto)

(Figure 1)

Setting the Clock Setting to Auto will automatically set the day and time using Extended Data Service (XDS) time data. This data is automatically retrieved from a PBS channel or other channel carrying this service.

Time Zone

(Figure 1)

When Auto has been selected for the Clock Setting, you need to select the correct time zone (Atlantic, Eastern, Central, Mountain, Pacific, Alaska, or Hawaii) for your area.

Daylight Savings Time

(Figure 1)

When Auto has been selected for the Clock Setting, you need to select the Daylight Savings Time (DST) option that your state uses (Applies = uses DST, or Ignore = does not use DST).

The clock time and day will be set automatically after tuning to a channel carrying the Extended Data Service (XDS) time data (usually your local PBS channel).

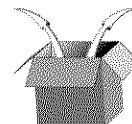

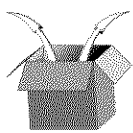

A/V Setting Descriptions: Audio

Audio Settings

- **Bass** enhances or reduces low frequency sound.
- **Treble** enhances or reduces high frequency sound.
- **Balance** adjusts the level of sound between the left and right speakers.
- **Surround** creates simulated stereo and surround effects. Your choices are:
 - **Off:** No surround effects. Use this setting when using an A/V receiver with Dolby™ Pro Logic Surround, or Dolby™ Digital Surround.
 - **Simulated Stereo:** Your TV will create a simulated stereo effect when watching a non-stereo program.
 - **Surround Sound:** Your TV will create a simulated surround effect when watching a stereo program.
- **Listen to** (for Ant-A and Ant-B) determines how your TV will receive a broadcast audio signal and play back the sound you hear. Your choices are:
 - **Stereo:** Default setting. The TV will play stereo broadcasts in stereo and mono broadcasts in mono. The word “Stereo” will be displayed when you tune to a channel broadcasting stereo.
 - **SAP (Second Audio Program):** Additional monaural soundtrack that you cannot hear during normal TV viewing. The SAP signal might be related to the program you are watching, such as a soundtrack in a foreign language, or unrelated to the program you are watching, such as a weather report. If a SAP signal is broadcast, the letters “SAP” will be displayed when you tune to the channel.
- **Mono:** Reduces background noise, and should be used when receiving a weak stereo audio signal. All audio will be played mono with this setting.
- **Listen to** (for INPUTs) is not available.
- **Level Sound** automatically equalizes the volume level of programs containing significant level differences from one segment to another (for example, regular Programming to commercials). To receive the best quality music programs, you can turn this setting to Off.



A/V Setting Descriptions: Video

Video Settings

- **IRIS™** is the Intelligent Room Illumination (light) Sensor. When IRIS™ is on, your TV will automatically adjust picture contrast and brightness for best quality (Contrast and Brightness cannot be adjusted manually).
- **Contrast** provides a slider to adjust the white-to-black level. Low contrast shows a variety of shades in darker images, while high contrast shows darker images more uniformly black and makes colors appear more vibrant.
- **Brightness** provides a slider to adjust the overall brightness of the picture.
- **Sharpness** provides a slider to adjust the detail and clarity.
- **Color** provides a slider to adjust the color intensity.
- **Tint** provides a slider to adjust the proportion of red to green.
- **Color Temp** (Color Temperature) allows you to adjust how white images are displayed. Your choices are:
 - **Low 6500K** or **Low** (for DTV): White images will have a warm cast to them. This adjustment is an average and can vary due to ambient room lighting, video scene brightness and the TV's age. The Low 6500K represents the 6500K industry standard for NTSC (non-DTV) pictures.
 - **Medium**: White images will be balanced between the Low (warm) and High (cool) settings.
 - **High**: White images will have a cool cast to them. This setting may provide the most realistic picture under bright lighting.
- **Video Noise** reduces minor noise (graininess) in the broadcast or input signal.
- **Image Type** maximizes the original camera media: Video or Film. Video media uses a video camera and is created at 30 frames per second. Film media uses a movie camera and is created at 24 frames per second. Examples of Video media are live TV broadcast such as news, special events, or video taped programs. Examples of Film media are motion pictures, made-for-TV movies, and many prime time programs. Filmed media is converted by the broadcaster or home video company to 30 frames per second to match TV or video standards. This conversion can leave subtle "picture artifacts" or conversion errors. Setting the Image Type to Film can reduce the picture artifacts and improve the picture quality, when viewing a 480i image.



Ever wish you were actually part of the movie or sitting in a field-level box at the 50-yard line, watching the game? The Mitsubishi total home theater system is the next best thing to being there. A home theater immerses you in both video and audio to a point of surrealism. The core of the home theater system is your bigscreen television, the biggest one your room can accommodate.

Smart TV

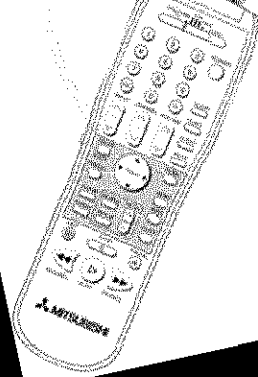

Operation

Remote Control Functions.....	50-57
Overview.....	50
Care and Operation	51
Channel Selection	52
Sleep Timer	52
System 4 Home Theater	
IR Control	53
Special Functions	54
Operation of PIP and POP ...	54-55
Display Formats	56-57
IMPORTANT NOTES #2.....	5

Remote Control Functions: Overview

Overview

(Following page, [page 1](#))

- 1 Slide Switch:** Select A/V product to be controlled by the remote control.
- 2 Numbers:** Individually select channels or input information into TV.
- 3 POWER:** Turns power on and off for TV and other A/V products.
- 4 SQV (Super Quick View™):** Scan through a memorized list of favorite channels.
- 5 QV (Quick View™):** Switch to last channel viewed.
- 6 HOME THEATER:** Enables the Home Theater IR System. Once enabled, a press of this key, when in the VCR, DVD, or Cable/DTV/DBS layer, will properly switch the inputs of the AV receiver and the TV so the audio and video automatically coincide.
- 7 SLEEP:** Set the TV to turn off within 2 hours. See *Sleep Timer*, page 52, for setup instructions.
- 8 VIDEO:** Select the video settings.
- 9 AUDIO:** Select the audio settings.
- 10 MUTE:** Turn sound on or off.
- 11 INPUT:** Select the signal to view (Ant-A, Ant-B, DTV, Input-1, Input-2, Input-3, Input-4, Component-1, Component-2, VGA, or STB).
- 12 CHANNEL:** Scroll up or down through memorized channels.
- 13 VOLUME:** Change sound level.
- 14 ENTER/EXCH:** Select a channel number or menu item. Exchange PIP or POP and main TV picture.
- 15 HOME:** Exit on-screen menus and return to TV viewing.
- 16 ADJUST:** Navigate menus, change settings, and move the PIP on-screen location.
- 17 CANCEL:** Clear SQV and some menu entries.
- 18 MENU:** Display 3D Graphical **ViewPoint®** on-screen menu system.
- 19 INFO:** Display on-screen summary of the current input used and any broadcast information available (including current V-Chip information).
- 20 GUIDE:** When the slide switch is set to CABLE/DBS/DTV, display the on-screen program guide (some cable boxes and DBS/DTV receivers).
- 21 V-CHIP:** Enable/Disable the V-Chip Lock.
- 22 FORMAT:** Change the shape and size of the main TV picture.
- 23 PIP INPUT:** Select the PIP or POP input source.
- 24 PIP/POP:** Cycle through PIP and POP display choices.
- 25 PIP CH:** Scroll up or down through memorized channels in PIP or POP.
- 26 REC:** Manually record with your VCR.
- 27 STOP:** Stop your VCR, DVD, or CD.
- 28 PAUSE:** Pause your VCR, DVD, CD, or freeze the PIP or POP image.
- 29 REW/REV:** Rewind or reverse search with your VCR, reverse scan with your DVD, or skip reverse with your CD.
- 30 PLAY:** Play your VCR, DVD, or CD.
- 31 FF/FWD:** Fast forward or forward search with your VCR, fast play with your DVD, or skip forward with your CD.

Remote Control Functions: Care and Operation

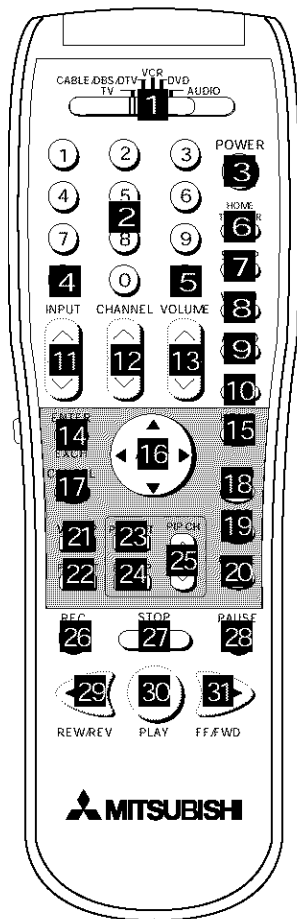

Figure 1. The remote control functions.

Operation

Installing the Batteries:

(Figure 2)

- 1 Remove the remote control's back cover by gently pressing the ridged tab in the direction of the arrow and sliding off the cover.
- 2 Load the batteries, making sure the polarities (+) and (-) are correct.

For Best Results from the Remote Control:

- ➔ Be within 20 feet of the equipment.
- ➔ Do not press two or more buttons at the same time unless instructed to.
- ➔ Do not allow to get wet or become heated.
- ➔ Avoid dropping on hard surfaces.
- ➔ Do not use harsh chemicals to clean. Use only a soft, lightly moistened cloth.
- ➔ Do not mix new and old batteries.
- ➔ Do not heat, take apart, or throw batteries into re
- ➔ Use only AAA batteries.

Operating the Remote Control:

You can use the remote to control the TV, CABLE/DBS/DTV, VCR, DVD, and AUDIO products. Select the product you want to control by moving the slide switch (1 of figure 1) to the appropriate position. The remote control has been preset to operate the TV and other Mitsubishi products. To program the remote control to operate other products, see *Use of the Remote Control with Other A/V Products*, pages 26-27.

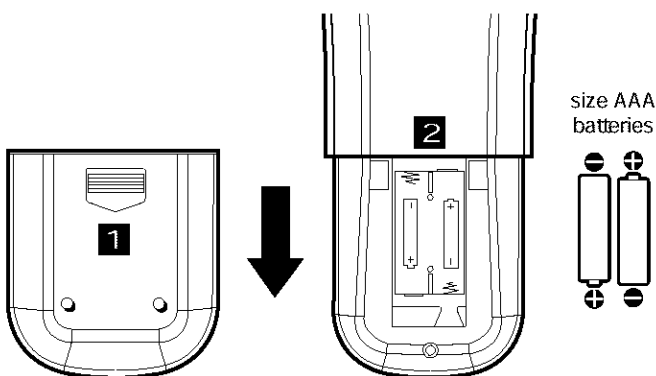

Figure 2. Installing the batteries.

IMPORTANT

- ➔ The remote control may return to its initial setting when the batteries are changed. You may need to reprogram.



Remote Control Functions: Channel Selection and Sleep Timer

Channel Selection

For Non-DTV Channels:

- Enter three numbers (for channel 2, press 002).
- or
- Press the channel number and ENTER (for channel 2, press 2, then ENTER).
- or
- Enter the channel number and wait four seconds. The TV will change automatically.

Sleep Timer

Setting the Sleep Timer:

- Press SLEEP on the remote control.
- A message indicating the length of time the sleep timer is to be set for is displayed on the TV screen.
- Each press of SLEEP will increase the time displayed by 30 minutes, until the maximum value of 120 minutes is reached.
- After 5 seconds of inactivity, the message will disappear.
- Press SLEEP to view the remaining time before the timer turns the TV off.

Canceling the Sleep Timer:

- Press SLEEP to display the on-screen message.
- Press SLEEP repeatedly until OFF is displayed.
- After 5 seconds of inactivity, the message box will disappear.

Remote Control Functions: System 4 Home Theater IR Control

The Mitsubishi System 4 Home Theater IR Control is a special feature that makes it easier to use your TV with a digital surround sound A/V receiver. Once your equipment is properly connected and set up, your TV and digital A/V receiver will change inputs together, to match high resolution pictures with the proper surround sound.

When you change inputs on your TV to watch different video products, your TV will send signals via your remote control and the infrared emitters to your digital A/V receiver

to change inputs. You will automatically hear the high quality digital surround sound from digital products like your DTV receiver and DVD player, and high quality analog stereo or surround sound from non-digital products like your VCR.

Additionally, all IR remote signals from your Mitsubishi remote or other manufacturers remote will be passed through your TV to your A/V devices. Your A/V devices can be hidden or behind cabinet doors and controlled by pointing the remote at the TV.

Remote Control Functions: System 4 Home Theater IR Control



Requirements for Operation

- A/V devices connected as described on page 15.
- Cable Box connected as on page 16 or Cable Box with an S-Video output connected as on page 19, *Connecting an S-Video Device*.
- TV connected to A/V receiver (TV Monitor Audio Out To A/V Receiver TV Input).
- TV Inputs renamed (see page 33 for naming help):

Cable Box connected to Ant A or B	=	Cannot be Renamed
Cable Box connected to STB	=	Rename To Cable
VCR connected to Inputs 1-4	=	Rename To VCR
DVD connected to any Input	=	Rename To DVD
Satellite Receiver connected to any Input	=	Rename To DBS
Digital Television Receiver on HD Input	=	Cannot Be Renamed
- Remote Control programmed to operate your other A/V Devices by System 4 properly activated (see pages 28-29).
- IR emitters properly connected and placed (see page 22).

IMPORTANT

➔ System 4 allows for only one of the following:

- Cable Box
- Satellite Receiver
- Digital TV Receiver

Operation (VCR as example)

To watch your VCR:

- 1 Turn on the TV and A/V Receiver.
- 2 Move slide switch to VCR.
- 3 Point remote at the TV and press the HOME THEATER button.
- 4 The TV and A/V Receiver should change to the appropriate inputs.
- 5 Operate the VCR.

IMPORTANT

➔ Other commands from your Mitsubishi remote control, or other manufacturer's remote, will be passed through the TV.

Remote Control Functions: Special Functions

When your remote control has been Programmed to operate another manufacturer's product, the function performed on each layer can vary. The most common functions are:

VCR				
•POWER	•PLAY	•PAUSE	•FF/FWD	
•CHANNEL up/down	•REC	•STOP	•REW/REV	
•Mitsubishi VCRs will be compatible with additional buttons				
Cable Boxes and Satellite Receivers				
•POWER	•ENTER (on some models)	•ADJUST up/down/left/right (on some models)		
•CHANNEL up/down	•CANCEL (on some models)	•GUIDE (on some models)		
•0-9 Number Buttons (on some models)				
A/V Receivers				
•POWER	•VOLUME	•MUTE		
Mitsubishi A/V Receivers				
•Direct Input Selection Buttons -use number buttons, SQV, and QV (on some models)				
Mitsubishi CD Players (not all functions for all models)				
•PLAY	•FF/FWD	•REW/REV	•PAUSE	•STOP
DVD and Laser Disc Players (not all functions for all models)				
•POWER	•PLAY	•ARROW up/down/left/right (on some models)	•PAUSE	•CANCEL (on some models)
•MENU	•STOP	•REW/REV	•ENTER	
•0-9 Number Buttons (on some models)				

Remote Control Functions: Operation of PIP and POP

Picture-In-Picture (PIP) and Picture-Outside-Picture (POP) features allow you to view Programming in different ways. While watching the main screen, you can display programs from other channels and other inputs. To see which inputs can and cannot be used together, see *How Connections Affect the PIP and POP* - Table 1, page 14. You can display large and small PIPs, side-by-side pictures, three POPs, or nine POPs.

Activating the PIP and POP

(Figures 1-5 on the following page)

Press PIP/POP to choose a display format. With each press of the PIP/POP button on the TV remote control (within 3 seconds of each other), the PIP/POP will cycle through the following display options.

- 1 POP: side-by-side pictures
- 2 POP: three POPs
- 3 POP: nine POPs
- 4 PIP: large PIP
- 5 PIP: small PIP

To turn PIP/POP off, wait at least 10 seconds, and press PIP/POP. The next time you activate PIP/POP, the last used PIP/POP format will be displayed.

Remote Control Functions: Operation of PIP and POP

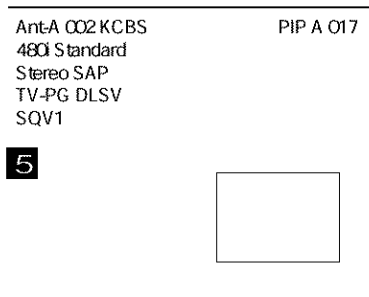
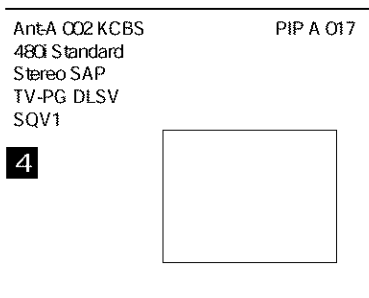
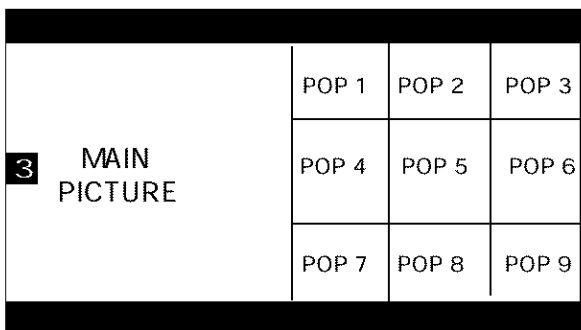
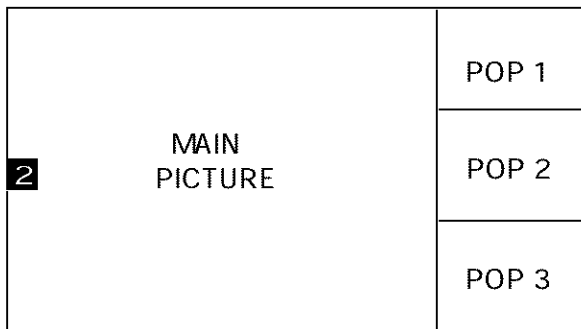
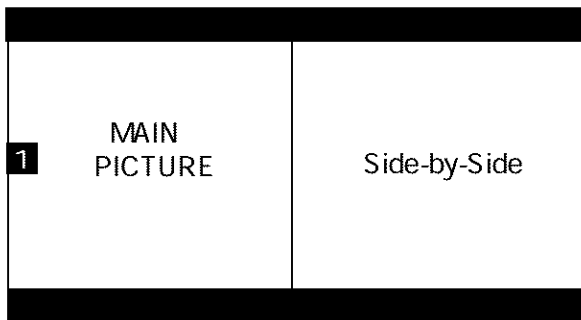

Changing PIP/POP Inputs

Press PIP INPUT to cycle through available inputs. To see which inputs can and cannot be used together, see *How Connections Affect the PIP and POP* - Table 1, page 14.

Changing PIP/POP Channels

Press PIP CH to scroll up and down through memorized channels on Ant-A, and Ant-B.

Exchanging Program Images

Press ENTER/EXCH to exchange the main picture and the PIP/POP picture.

Moving PIP Image

Press ADJUST ▲, ▼, ◀, or ▶ to move the PIP display anywhere on the main screen.

Automatic POP Switching

When automatic POP switching is active, the TV will cycle through memorized channels or strobe pictures from other A/V components in the POP display. Press PAUSE to activate/pause automatic POP switching.

Selecting POP “Live” Image

Press ADJUST ▲, ▼, ◀, or ▶ to select a different POP “live” image (automatic POP switching must be paused).

Freeze the PIP and Side-By-Side Picture

Press PAUSE to freeze the PIP and side-by-side images. Press Pause again to return to a “live” image.

PIP/POP Audio Signal

For PIP/POP audio connection illustration, see *Back Panel Functions* - 3, page 13. Volume for the PIP AUDIO OUTPUT is controlled by the amplifier or wireless headphones.

Remote Control Functions: Display Formats

This is a wide screen TV (also known as a 16:9 TV). This shape reæt st ðe new types of images available from HDTV and many DVDs. There are still many older style narrow screen images (called 4:3 aspect ratio) you will encounter. While there will never be a perfect solution for displaying a narrow image on a wide screen, Mitsubishi offers several display formats to choose from.

Press **FORMAT** on the TV remote control to cycle through the ve avai lãbl edi pl ay formats.

IMPORTANT

→ When displaying VGA or HDTV (1080i) signals, the **FORMAT** control will not operate. All HD signals will automatically be shown using the Standard format, and will ll ðe screen.

IMPORTANT

→ Stretched and Zoom formats are not available during PIP/POP functions.

IMPORTANT

→ Caution should be observed when using the Narrow format due to the stationary gray side bars. Please see pages 23 or 58 for guidelines concerning stationary images.

- 1 Standard:** This is the full screen format. HDTV signals will automatically use this format. This format is also useful to display Anamorphic DVDs that have 1.78:1 or 1.85:1 aspect ratios. Anamorphic DVDs that have the 2.35:1 aspect ratio will still display black bars at the top and bottom. Narrow (4:3) images will be stretched evenly from side to side.
- 2 Expand:** This will enlarge the picture, cropping off some of the image at the top and bottom. This is useful to reduce the letterbox top and bottom bars of non-anamorphic DVDs or to correct narrow (4:3) images that have been stretched in the Standard format.
- 3 Zoom:** This will enlarge the picture, cropping off some of the image at each side, and top and bottom. This is useful to remove or reduce the black top and bottom bars on anamorphic DVDs with a 2.35:1 aspect ratio.
- 4 Stretched:** (Not available when viewing 480p signals) This format will stretch a narrow (4:3) image across the screen, however, there is less stretch in the center than the sides. This will allow the entire narrow image to be displayed across the screen with less distortion than seen in the Standard format.
- 5 Narrow:** This format will display narrow (4:3) images in their original shape, and add stationary gray side bars to ll ðe screen.

Non-Anamorphic Picture (4:3)

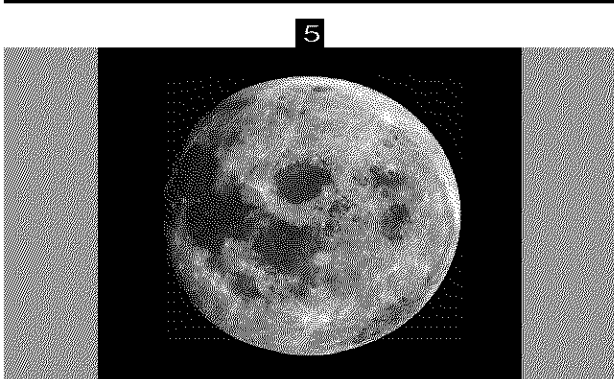
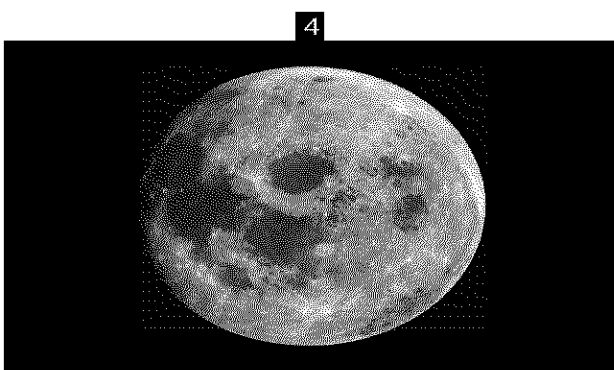
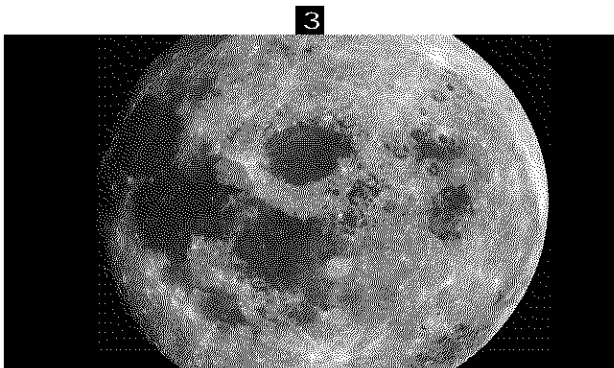
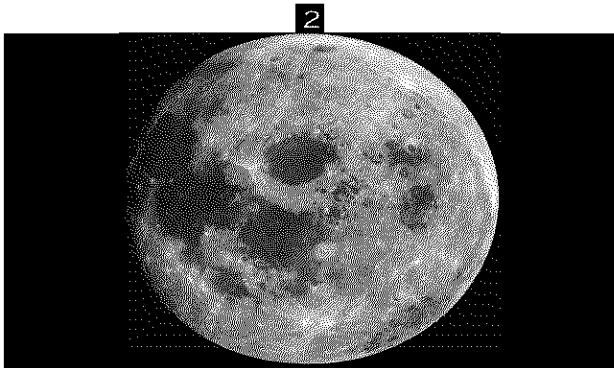
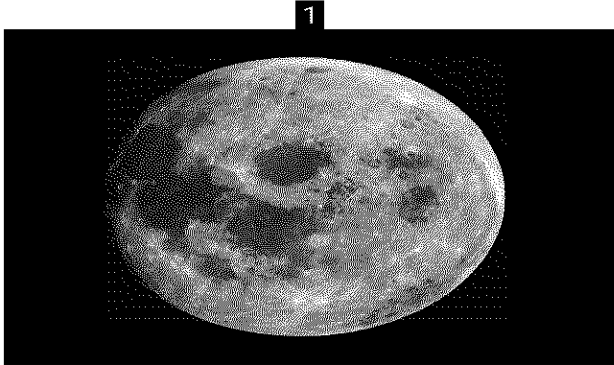

Anamorphic Widescreen Picture (16:9)

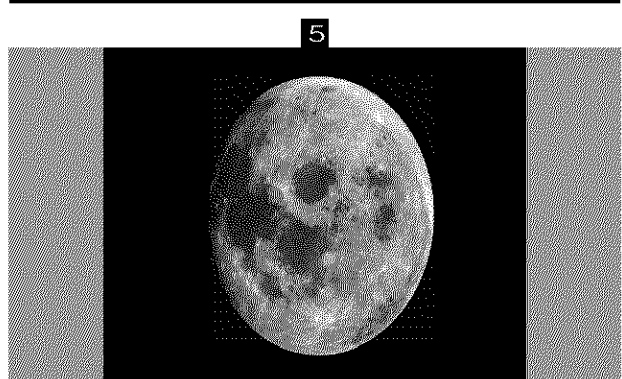
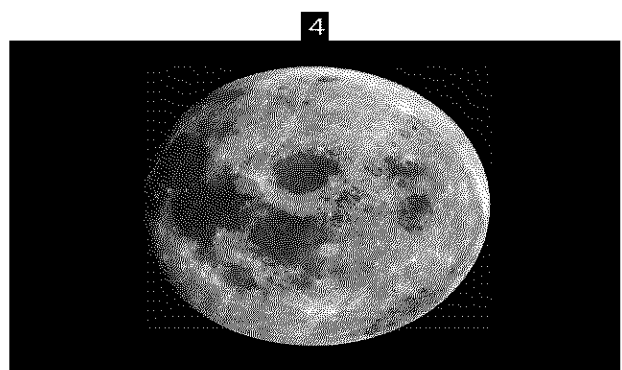
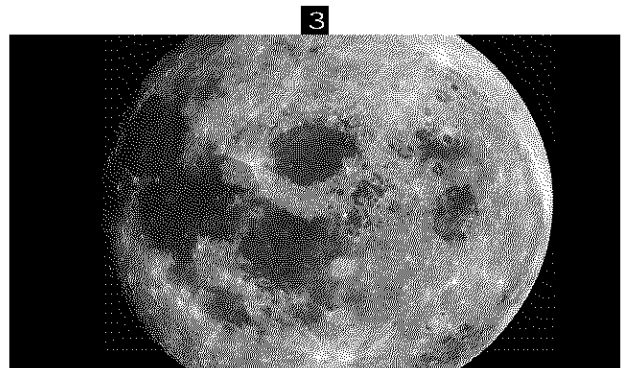
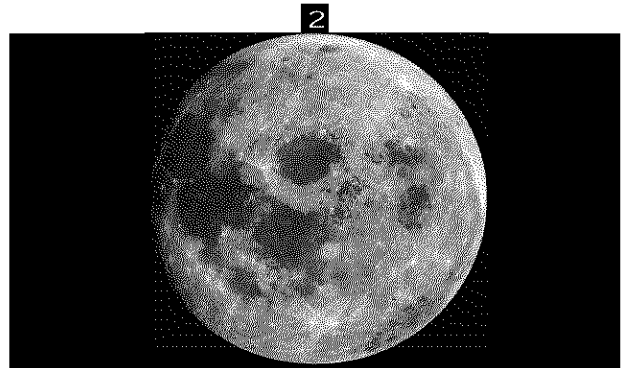
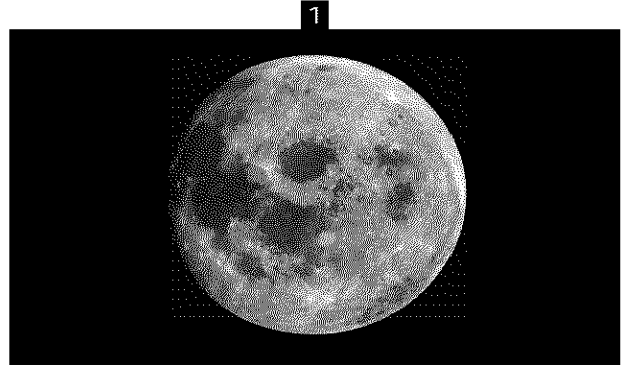

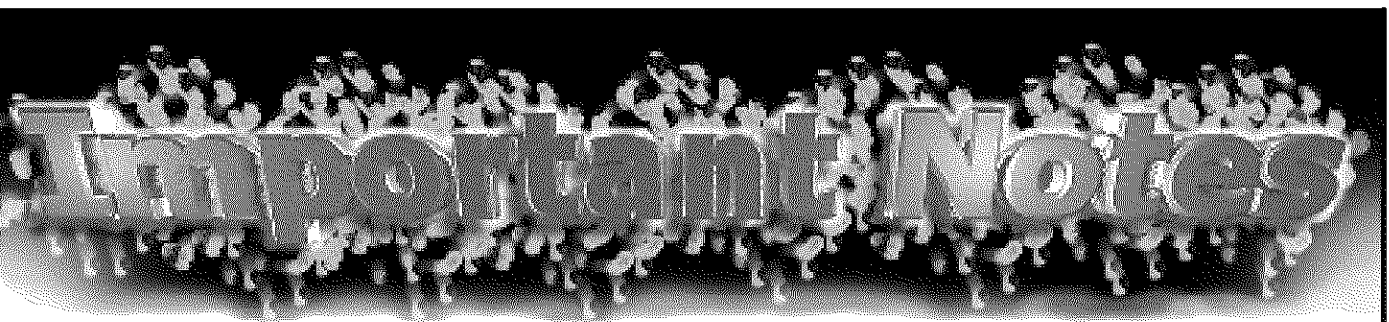

Warning: Do not leave stationary or letterbox images on-screen for extended periods of time. Mix the types of pictures shown. Uneven picture tube aging is NOT covered by your warranty.

The normal use of a TV should include a mixture of TV picture types. The most frequently used picture types should fill the screen with constantly moving images rather than stationary images or patterns. Displaying the same stationary patterns over extended periods of time, or displaying the same stationary pattern frequently can leave a subtle but permanent ghost image. To avoid this, mix your viewing pattern. Do not show the same stationary image for more than 15% of your total TV viewing in any one week. Display constantly moving and changing images that fill the screen whenever possible.

This projection TV uses picture tubes to project the image to the screen. **All picture tubes age with use.** As they age, their light output is gradually reduced. Normal TV pictures fill the screen with constantly changing images. Under these conditions, picture tubes age at an even rate across the entire screen. This maintains a TV picture that is evenly bright over the whole screen. Stationary images or images that only partially fill the screen (leaving black or colored bars to fill the screen), when used over extended periods of time or when viewed repeatedly, can cause uneven aging of the phosphors and leave subtle ghosts of the stationary images in the picture.

Still or stationary images may be received from broadcasters, cable channels, satellite channels, DVD discs, video tapes, laser discs, on-line services, web/internet searching devices, video games, and digital TV tuner/converter boxes. Examples of these types of images can be, but are not limited to the following:

- ➡ **Letterbox top/bottom black bars:** shown at the top and bottom of the TV screen when you watch a widescreen (16:9) movie on a standard (4:3) TV.
- ➡ **Side bar images:** solid bars shown on each side of an image when watching a standard (4:3) program on a widescreen (16:9) TV.
- ➡ **Stock-market report bars:** ticker running at the bottom of the TV screen.
- ➡ **Shopping channel logos & pricing displays:** bright graphics that are shown constantly or repeatedly in the same location.
- ➡ **Video game patterns and scoreboards**
- ➡ **Bright station logos:** moving or low-contrast graphics are less likely to cause uneven aging of the picture tubes.
- ➡ **On-line (internet) web sites:** or any other stationary or repetitive computer style images.

Lock Bypass Instructions Have Been Filed for Future Reference

A

Appendix A: Bypassing the V-Chip Lock

59

A

Appendix A: Bypassing the V-Chip Lock

59

Bypassing the V-Chip Lock

After you set the lock, you need your passcode to view a V-Chip locked program, view the locked TV, cancel the lock, or enter the V-Chip lock menus.

If you forget your passcode, you can view the locked TV without entering your passcode. This is done by pressing the number 9 and QV buttons on the remote TV control at the same time, when your passcode is requested. This process temporarily unlocks the TV.

When entering the V-Chip Lock menu, this process deletes your old passcode and prompts you to enter a new passcode.

IMPORTANT

- Cut along the dotted line and le bypass instructions in a safe place for future reference.

IMPORTANT

- When changing or deleting your passcode, you must use the remote control included with this TV. You cannot use a Mitsubishi remote control from another component or a "universal" remote.



Component-1 and Component-2 Inputs

These inputs are compatible with component video signals from standard DVD players and other equipment sending a standard NTSC component video signal (480i).

These inputs may also be compatible with newer DVD players sending a progressive NTSC component video signal (480p).

VGA Input

This input will accommodate most computers capable of supporting a VGA monitor. The only compatible display resolution is 640x480. The sync rate is 60hz. SVGA and XVGA resolutions are not supported.

DTV Input

This input is compatible with most standard DTV receivers with component video outputs. Compatible DTV signals are SDTV 480i, 480p, and HDTV 1080i. All other DTV signals, such as 720p, need to be converted by the DTV receiver to one of the compatible signal types. Please check the DTV receiver specifications before connecting.

This input is also compatible with some DTV receivers using RGB with "sync on green" or RGB with "separate H and V sync". Compatible DTV signals are SDTV 480i, 480p, and HDTV 1080i. All other DTV signals, such as 720p, need to be converted by the DTV receiver to one of the compatible signal types. Industry standards for DTV RGB signals systems, synchronization, timing, and signal strengths are not currently established. These inputs will not be compatible with all DTV receivers that offer RGB. If your DTV receiver offers both DTV component video signals and DTV RGB signals, Mitsubishi suggests you use the DTV component video signals. Please check the DTV receiver specifications before connecting.

Input Levels and Timing with Component Video

- ▶ Y =1.0Vp-p (includes sync) 75ohms
- ▶ Pr =700mVp-p, 75ohms (can also receive signals from outputs labeled R-Y and Cr)
- ▶ Pb =700mVp-p, 75ohms (can also receive signals from outputs labeled B-Y and Cb)

Input Levels and Timing When Used With Component Video Signals

EIA - 770.3 Standard Levels and Timing

- ▶ Y =1.0Vp-p (includes sync) 75ohms
- ▶ Pr =700mVp-p, 75ohms
- ▶ Pb =700mVp-p, 75ohms
- ▶ H =Not Used
- ▶ V =Not Used

Input Levels and Timing When Used With RGB Video Signals

- ▶ G_(Y) =1.0Vp-p 75ohms (compatible with sync on green)
- ▶ R_(Pr) =700mVp-p, 75ohms
- ▶ B_(Pb) =700mVp-p, 75ohms
- ▶ H =4Vp-p+/-1.0v, 75ohms
(when using separate H and V sync)
- ▶ V =4Vp-p+/-1.0v, 75ohms
(when using separate H and V sync)



A/V Receivers

Mitsubishi	010, 011, 012, 013, 014, 015
Admiral	220
Aiwa	225, 226
Denon	234, 235, 236
Fisher	204
Gerrard	213
Harman Kardon	215
Jensen	223
JVC	232, 233
Kenwood	200, 208
Magnavox	227, 228
Marantz	224
McIntosh	216
Nakamichi	206, 217
Onkyo	209, 214
Optimus	203, 227, 231, 230
Panasonic	219, 218, 221
Philips	223
Pioneer	205, 207
Quasar	219, 218, 221
RCA	203, 205, 227, 231, 230
Sansui	203, 211, 239
Sharp	234, 237
Sony	222
Sound-sigh	238
TEAC	212, 213, 210, 211
Technics	221, 218, 219
Victor	232, 233
Yamaha	201, 202

Cable Box

ABC	124
Archer	132, 125
Cableview	105, 132
Citizen	122, 105
Color Voice	128, 129, 130, 106, 107
Comtronics	128, 129, 130, 106, 107
Curtis	112, 113
Diamond	124, 132, 125
Eagle	129
Eastern	134
GC Brand	132, 105
GE	111, 112, 113
Gemini	122, 143
General Instrument	
/Jerrold	111, 119, 120, 121, 122, 123, 124, 125, 126, 127
Hamlin	140, 141, 142, 145, 118, 112
Hitachi	103, 124
Macom	103, 104, 105, 108
Magnavox	128, 129, 130, 106, 107, 133, 138
Memorex	130
Movietime	132
Oak	139, 137, 102
Panasonic	109, 110, 114
Paragon	117
Philips	128, 129, 130, 106, 107, 133, 138
Pioneer	101, 116
Pulsar	105, 132
Puser	132
RCA	115
Realistic	132
Regal	112, 118, 140, 141, 142, 145
Regency	134
Rembrandt	137, 132, 105, 138
Samsung	105
Satellite	100
Scienti cA lant a	111, 112, 113
Signature	119, 124, 125, 126, 127, 120, 121, 122, 111
SL Mark	105, 101
Sprucer	105, 110
Starcom	119, 124, 125, 126, 127, 120, 121, 122, 111
Stargate	132, 105
Televue	101, 105
Texscan	144
Tocom	135, 136
Toshiba	104
Unika	132, 125
United Artists	139, 137, 102
United Cable	119, 124, 125, 126, 127, 120, 121, 122, 111
Universal	122, 132
Videoway	106
Viewstar	129, 130
Zenith	117, 100

VCRs

Mitsubishi	001, 002, 060, 067, 068, 061, 062
Admiral	055
Aiwa	047, 052
Akai	049, 034, 035, 036
Audio Dynamic	059, 031
Bell & Howell	025, 033
Broksonic	040, 046
Canon	043, 045
Citizen	026
Craig	025, 049, 026
Curtis Mathes	065, 044, 047
Daewoo	063, 021, 044, 079
DBX	059, 030, 031
Dimensia	065
Emerson	023, 038, 039, 040, 045, 046, 062, 063
Fisher	025, 028, 029, 027
Funai	047, 046, 040
GE	057, 065, 044
Go Video	057, 069, 070, 071
Goldstar	026
Hitachi	043, 065, 020
Instant Replay	044, 043
Jensen	059
JVC	059, 030, 031, 054, 076, 077
Kenwood	059, 030, 026, 031
LXI	047, 026, 020, 027, 028, 025, 029
Magnavox	051, 043, 044
Marantz	059, 030, 031
Marta	026
Memorex	044, 029
MGA	058, 060, 067, 068, 061, 062
Minolta	020, 065
Multitech	067, 047, 024
NEC	059, 030, 031, 054
Olympic	044, 043
Optimus	048, 041, 055, 026
Orion	046, 040
Panasonic	043, 044, 041, 042
Penney	044, 020, 065, 025, 059, 030, 031
Pentax	020, 031, 065
Philco	051, 044, 047, 043, 046, 040
Philips	051, 043, 044
Pioneer	043
Proscan	065, 020, 043, 044, 051, 066, 021, 022
Quasar	041, 042, 043, 044
Radio Shack	053, 044, 025, 056, 029, 060, 047
RCA	053, 065, 020, 043, 044, 049, 051, 066, 021, 022
Realistic	044, 025, 056, 029, 060, 047
Samsung	057, 022, 024, 053
Sansui	059, 046, 040, 072
Sanyo	025, 029
Scott	021, 022, 024, 029, 058, 060, 067, 068, 046, 040
Sears	025, 026, 027, 028, 020
Shantom	037
Sharp	055, 056
Signature 2000	047, 055
Singer	037
Sony	048, 049, 050, 073, 074, 075
SV2000	047
Sylvania	051, 043, 044, 047
Symphonic	047
Tashiro	026
Tatung	059, 030, 031
TEAC	059, 030, 047, 031
Technics	032, 041, 042, 043, 044
Teknika	044, 047
Toshiba	021, 066
Totevision	026
Vector Research	031
Wards	055, 056, 029, 064, 026
Yamaha	025, 059, 030, 031
Zenith	064

DVD Players

Mitsubishi	003
Denon	250
Ferguson	251
GE	251
JVC	257
Normande	251
Panasonic	250
Philips/Magnavox	258
Pioneer	252
RCA/Proscan	251, 256
Saba	251
Sony	254
Thompson	251
Toshiba	253
Yamaha	250
Zenith	259

Satellite Receivers

Mitsubishi	
HD/Satellite Receiver	006
Echostar/Dishnetwork	175
GE	176
Hitachi	173, 181
Hughes	173
Panasonic	174
Philips	171, 172
Primestar	178
RCA	176, 179, 180
Sony	177
Toshiba	170
Uniden	171, 172

Cleaning

Normally, light dusting with a dry, non-scratching duster will keep your TV clean. Use care when cleaning your TV with any other product. If you want to gently wipe down your TV with a lightly moistened soft cloth, **turn off and unplug your TV.** You can add a few drops of mild liquid detergent to the water for oily dirt.

- ➔ DO NOT allow liquid to enter the TV through the ventilation slots.
- ➔ DO NOT use strong or abrasive cleaners.
- ➔ DO NOT use spray liquids or cleaners directly on the TV's surface.
- ➔ DO NOT scrub or rub the TV harshly.
- ➔ When cleaning the screen behind the Diamond Shield™, wipe GENTLY up and down with the grooves. Do not allow any liquid to drip down the screen into the TV.

IMPORTANT

- ➔ DO NOT use any kind of abrasive, liquid, or spray cleaner on the surface of the TV screen.

Service

If you are unable to correct a problem with your TV, consult your Mitsubishi dealer or a Mitsubishi Authorized Warranty Service Center.

- ➔ DO NOT adjust any controls other than those described in this Owner's Guide.
- ➔ DO NOT remove the protective back cover of your TV.

Menus not described and shown in this owner's guide are designed for Factory use and for Authorized Service Personnel. If you see a menu or display not described in this owner's guide, make no changes to the settings, turn off the TV to clear the displays and return to normal operation. Non-authorized changes and changes made by non-authorized persons may void all or part of the warranty.

IMPORTANT

- ➔ For further assistance, please call
(800) 332-2119

Problem	Possible Solution
<ul style="list-style-type: none"> The TV remote control does not work. 	<ul style="list-style-type: none"> Check that the batteries are installed correctly. Check that the selected switch is set to "TV". Be no further than 20 feet from the TV when using the remote control.
<ul style="list-style-type: none"> The TV takes several seconds to respond to channel commands. 	<ul style="list-style-type: none"> Press ENTER after a channel number to avoid delays. Use the three digit number, i.e 002 for channel 2.
<ul style="list-style-type: none"> You cannot access a channel. 	<ul style="list-style-type: none"> Use number keys instead of CHANNEL up/down. Be sure the channel you want to view is in memory. Check that the TV is turned to the correct input source for that channel, by pressing the INPUT button. Make sure the V-Chip lock is off (page 36).
<ul style="list-style-type: none"> On-screen displays appear each time you change a function. 	<ul style="list-style-type: none"> This is part of normal TV operation.
<ul style="list-style-type: none"> You cannot program the TV to turn on automatically. 	<ul style="list-style-type: none"> The TV may be locked. The clock may not be set.
<ul style="list-style-type: none"> There is no sound even when the volume is turned up. 	<ul style="list-style-type: none"> Check to see if the MUTE button is on. The TV's "Listen to:" setting may be set to SAP. Check that "TV Speakers" setting is ON.
<ul style="list-style-type: none"> You have forgotten your lock passcode. 	<ul style="list-style-type: none"> See <i>Appendix A, Bypassing the V-Chip Lock</i>, page 59.
<ul style="list-style-type: none"> PIP does not display a picture. 	<ul style="list-style-type: none"> Make sure the V-Chip lock is off (page 36). Not all inputs can be displayed as a PIP (page 14).
<ul style="list-style-type: none"> The sound does not match the screen picture. 	<ul style="list-style-type: none"> The TV's "Listen to:" setting may be set to SAP. If using stereo or A/V receiver speakers, check input selection on the stereo or A/V receiver. If using stereo or A/V receiver, check that AUDIO is from MONITOR OUTPUT on TV's back panel.
<ul style="list-style-type: none"> There is a large black or gray rectangle on the screen. 	<ul style="list-style-type: none"> The TV closed captioning has been set to "text" mode, but there is no text information being broadcast. Turn Off in the CLOSED CAPTIONS menu (page 34).
<ul style="list-style-type: none"> You cannot see a picture when you play a VCR tape. 	<ul style="list-style-type: none"> If you connected your VCR with A/V cables, use the INPUT button to select the Input source (INPUT-1, INPUT-2, INPUT-3, or INPUT-4) that the VCR is connected to. Check your VCRs owner's guide for further troubleshooting.
<ul style="list-style-type: none"> V-Chip Lock is not working. 	<ul style="list-style-type: none"> Make sure that V-Chip is On (page 36). If V-Chip Hours/Lock by Time is currently set to dissable the V-Chip lock, the V-Chip will not block programing.
<ul style="list-style-type: none"> Menu does not appear when the MENU button is pressed. 	<ul style="list-style-type: none"> Turn TV power off. Turn TV power on. Press menu button.

A

adding and deleting channels 35
 Advanced Features menu 39
 adaptors (BNC to RCA), 20
 adjusting (convergence), 40-41
 alignment (convergence), 40-41
 antennas (connecting), 16
 assistance, 63
 audio settings 46

B

back panel, 13
 balance, 46
 bass, 46
 Black Enhancement, 41
 blocking (enabling V-Chip), 36-38
 brightness, 12, 47
 bypassing (parental lock), 59

C

cleaning, 4, 63
 Clock (setting), 44-45
 compatibility (signal), 61
 contrast, 12, 47
 convergence, 40-41

D

date (setting), 39, 44-45
 daylight savings time (DST), 45
 dusting, 63

E

español, 33
 EXCH button on remote, 55

F

formats (display), 56-57
 front control panel, 12

G

games, 23, 58
 ghost, 23, 58

H

Home Theater IR (System 4)
 activation, 28-29
 connection, 14-15, 22
 special setups, 15
 remote control functions, 50

I

IMPORTANT NOTES, 23, 58
 Important Safeguards, 4-5
 interlaced, 41
 IRIS™, 12, 47

L

language, 31, 33, 46
 letterbox, 2, 19, 23, 56, 58
 lighting, 12, 47
 locked, 36-38, 59, 64

M

maintenance, 2, 67
 memorize channels, 33
 memory (channel), 35

N

naming channels, 35
 naming inputs, 33

P

passcode, 36, 59
 Picture-in-Picture (PIP)
 Setup, 14
 Operation, 54-55
 Picture-outside-Picture (POP)
 Setup, 14
 Operation, 54-55

Q

Quick View™ (QV), 50

R

remote control
 Settings
 Audio, 46
 Video, 47
 care and operation, 51
 channel selection, 52
 functions, 50-57
 installing batteries, 51
 programming codes, 26-27, 62
 replacement, 6
 Sleep Timer, 52
 reset (A/V), 12, 42

S

safeguards, 4-5
servicing, 2, 5, 63
signal types
 1080i, 56, 61
 480i, 41, 61
 480p (progressive DVD), 41, 61
 720p, 61
 960i, 41
Sleep Timer, 52
sound (adjusting), 46
Spanish, 33
Special Functions, 54
SQV (Super Quick View™), 35
stand, 4
STATIONARY PICTURE
WARNING, 19, 23, 58
surface, 4, 63
surges, 5

T

time (setting), 44-45
Timer (turn TV on), 39
Timer (Sleep), 52
treble, 46
Troubleshooting, 64
TV speakers, 43

U

unpacking, 9
upgradeable, 9

V

V-Chip Lock, 36-38
 bypassing, 59
 entry to, 36
 Hours/Lock by Time, 38
 passcode setting, 36
 ratings and categories, 37
 signal information, 37
ventilation, 4, 63
Video Display, 41
Video Mute, 41
Video Settings, 47

W

Mitsubishi Limited Warranty, 67

MITSUBISHI PROJECTION TELEVISION LIMITED WARRANTY

MITSUBISHI DIGITAL ELECTRONICS AMERICA, INC. ("MDEA") warrants to the original purchaser of this television that if purchased from an authorized MITSUBISHI Audio/Video Dealer, should it prove defective by reason of improper workmanship and/or material:

- a. **Parts.** The lenticular (i.e. front picture) screen and/or the DiamondShield™ is warranted against defects in materials and workmanship for a period of 30 days. All other parts are warranted for a period of one year from the date of the original purchase at retail. We will repair or replace, at our option, any defective part without charge for the part. Parts used for replacement are warranted for the remainder of the original warranty period.
- b. **Labor.** For 30 days after the original purchase at retail, we will repair or replace, at our option, the lenticular screen if it proves defective. For all other parts, we will provide the labor for a warranty repair by an authorized MITSUBISHI service center without charge for one year from the original date of purchase at retail.
- c. **Notice.** To obtain warranty service, you must notify an authorized MITSUBISHI service center of any defect within the applicable warranty time period.

1. TO OBTAIN WARRANTY SERVICE:

- a. Contact your nearest authorized MITSUBISHI service center whose name and address can be obtained from your MITSUBISHI dealer or by writing or calling MDEA at the address and telephone number provided below.
 - b. Warranty service will be provided in your home or, if required, at an authorized service shop, provided that your television is located within the geographic territory customarily covered by an authorized MITSUBISHI service center. If not, you must either deliver your television to an authorized service location at your own expense, or pay for any travel and/or transportation costs the service center may charge to and from your home. Actual service labor will be provided without charge.
 - c. Proof of purchase date from an authorized MITSUBISHI dealer is required when requesting warranty service. Present your sales receipt or other document which establishes proof and date of purchase. **THE RETURN OF THE OWNER REGISTRATION CARD IS NOT A CONDITION OF WARRANTY COVERAGE.** However, please return the Owner Registration Card so that we can contact you should a question of safety arise which could affect you.
2. THIS WARRANTY DOES NOT COVER damage caused by: modification, alteration, repair or service of the product by anyone other than an authorized MITSUBISHI service center; physical abuse to, or misuse of, the product; operation in a manner contrary to the instructions which accompany the product, including uneven picture tube aging and imprinted images on the viewing screen; freight damage; or any damage caused by acts of God such as lightning or fluctuation in electrical power. This warranty also excludes all costs arising from installation, adjustment of user controls external antenna systems, service of products purchased or service outside the U.S.A., initial technical adjustments (set-up) and user-required maintenance. Consult the operating instructions furnished with the product for information regarding user controls.
3. ANY EXPRESS WARRANTY NOT PROVIDED HEREIN, AND ANY REMEDY WHICH, BUT FOR THIS PROVISION, MIGHT ARISE BY IMPLICATION OR OPERATION OF LAW, IS HEREBY EXCLUDED AND DISCLAIMED. THE IMPLIED WARRANTIES OF MERCHANTABILITY AND FITNESS FOR ANY PARTICULAR PURPOSE ARE EXPRESSLY LIMITED TO A TERM OF ONE YEAR.
4. UNDER NO CIRCUMSTANCES SHALL MDEA BE LIABLE TO PURCHASER OR ANY OTHER PERSON FOR ANY INCIDENTAL, SPECIAL OR CONSEQUENTIAL DAMAGES, WHETHER ARISING OUT OF BREACH OF WARRANTY, BREACH OF CONTRACT, OR OTHERWISE.
5. Some states do not allow limitations on how long an implied warranty lasts, or the exclusion or limitation of incidental, special or consequential damages, so the above limitations or exclusions may not apply to you.
6. This warranty gives you specific legal rights and you may also have other rights which vary from state to state.
7. BEFORE REQUESTING SERVICE, please review the instruction booklet to insure proper installation and correct customer control adjustment. If the problem persists, contact your nearest MITSUBISHI Dealer for the name(s) of authorized MITSUBISHI Service Center(s). If you are unable to obtain this information, please call 800-332-2119, or write us at the address below.

MITSUBISHI DIGITAL ELECTRONICS AMERICA, INC.
 9351 Jeronimo Road
 Irvine, CA 92618-1904



Mitsubishi Projection TV Limited Warranty

RETAIN THIS PORTION FOR YOUR RECORDS SERIAL NO. _____
 MODEL NO. _____

DEALER NAME _____
 STREET ADDRESS _____
 CITY _____ STATE _____ ZIP _____
 PHONE () _____ PURCHASE DATE _____



If you have questions regarding your television, call Consumer Relations at (800) 332-2119, or email us at MD_EA_service@bigscreen.mea.com

To order replacement or additional remote controls or owner's guides
call (800) 553-7278

or

visit our website at www.mitsubishi-tv.com