

# INSTRUCTION MANUAL

# SKR001



 Read before use.

# Introduction

## Purchase

Congratulations on the purchase of a Makita Rotating Laser product.



This manual contains important safety directions as well as instructions for setting up the product and operating it. Refer to [1 Safety Directions](#) for further information.

Read carefully through the User Manual before you switch on the product.

## Product identification

The model and serial number of your product are indicated on the type label. Always refer to this information when contacting your agency or Makita authorised service centre.

## Available documentation

Name	Description/Format		
SKR001 Quickstart Guide	Provides an overview of the product. Intended as a quick reference guide.	✓	✓
SKR001 Instruction Manual	All instructions required in order to operate the product to a basic level are contained in the Instruction Manual. Provides an overview of the product together with technical data and safety directions.	-	✓

# Table of Contents

<b>1</b>	<b>Safety Directions</b>	<b>5</b>
1.1	General	5
1.2	Definition of Use	6
1.3	Limits of Use	6
1.4	Responsibilities	6
1.5	Hazards of Use	7
1.6	Laser Classification	13
	1.6.1 General	13
	1.6.2 SKR001	13
1.7	Electromagnetic Compatibility (EMC)	14
<b>2</b>	<b>Description of the System</b>	<b>16</b>
2.1	System Components	16
2.2	SKR001 Laser Components	17
2.3	Case Components	17
2.4	Setup	18
<b>3</b>	<b>Operation</b>	<b>19</b>
3.1	Buttons	19
3.2	LED Indicators	20
3.3	Turning the SKR001 On and Off	21
3.4	Automatic Mode	22
3.5	Manual Mode	22
3.6	Horizontal Use	25
3.7	Layout/Laydown Use	25
3.8	Height of Instrument Alert (H.I.Alert) function	25
3.9	RC1 Remote Control	28
	3.9.1 Pairing the SKR001 with the RC1 Remote Control	29
<b>4</b>	<b>LDX2 Digital Receiver</b>	<b>31</b>
<b>5</b>	<b>Applications</b>	<b>37</b>
5.1	Setting Forms	37
5.2	Checking Grades	38
5.3	Manual Grades	39
5.4	Suspended Ceilings	40
5.5	Layout/Laydown Mode	41
5.6	More Applications	42
<b>6</b>	<b>Batteries</b>	<b>43</b>
6.1	Operating Principles	43
6.2	Battery for SKR001	43
<b>7</b>	<b>Accuracy Adjustment</b>	<b>46</b>
7.1	Checking the Level Accuracy	46
7.2	Adjusting the Self-Levelling Accuracy	47
	7.2.1 Horizontal Position	47
	7.2.2 Laydown Position	51
<b>8</b>	<b>Troubleshooting</b>	<b>54</b>

<b>9</b>	<b>Care and Transport</b>	<b>57</b>
9.1	Transport	57
9.2	Storage	57
9.3	Cleaning and Drying	58
<b>10</b>	<b>Technical Data</b>	<b>59</b>
10.1	Conformity to National Regulations	59
10.1.1	SKR001	59
10.1.2	RC1 Remote Control	61
10.1.3	LDX2 Digital Receiver	61
10.2	General Technical Data of the Product	62
10.2.1	SKR001	62
10.2.2	RC1 Remote Control	63
10.2.3	LDX2 Digital Receiver	64
10.3	Dangerous Goods Regulations	65
<b>11</b>	<b>Accessories</b>	<b>66</b>



# 1 Safety Directions

## 1.1 General

### Description

The following directions enable the person responsible for the product, and the person who actually uses the equipment, to anticipate and avoid operational hazards.

The person responsible for the product must ensure that all users understand these directions and adhere to them.

### About warning messages





Warning messages are an essential part of the safety concept of the instrument. They appear wherever hazards or hazardous situations can occur.

#### Warning messages...

- make the user alert about direct and indirect hazards concerning the use of the product.
- contain general rules of behaviour.

For the users' safety, all safety instructions and safety messages shall be strictly observed and followed! Therefore, the manual must always be available to all persons performing any tasks described here.

**DANGER, WARNING, CAUTION** and **NOTICE** are standardised signal words for identifying levels of hazards and risks related to personal injury and property damage. For your safety, it is important to read and fully understand the following table with the different signal words and their definitions! Supplementary safety information symbols may be placed within a warning message as well as supplementary text.

Type	Description
 <b>DANGER</b>	Indicates an imminently hazardous situation which, if not avoided, will result in death or serious injury.
 <b>WARNING</b>	Indicates a potentially hazardous situation or an unintended use which, if not avoided, could result in death or serious injury.
 <b>CAUTION</b>	Indicates a potentially hazardous situation or an unintended use which, if not avoided, may result in minor or moderate injury.
<b>NOTICE</b>	Indicates a potentially hazardous situation or an unintended use which, if not avoided, may result in appreciable material, financial and environmental damage.
	Important paragraphs which must be adhered to in practice as they enable the product to be used in a technically correct and efficient manner.

## 1.2

## Definition of Use

---

### Intended use

- Projection of horizontal and vertical laser lines and laser points
  - The laser beam can be detected by means of a laser receiver
  - Remote control of product
- 

### Reasonably foreseeable misuse

- Use of the product without instructions
  - Use outside of the intended use and limits
  - Disabling of safety systems
  - Removal of hazard notices
  - Opening the product using tools, for example a screwdriver, unless this is permitted for certain functions
  - Modification or conversion of the product
  - Use after misappropriation
  - Use of products with recognisable damage or defects
  - Use with accessories from other manufacturers without the prior written explicit approval of Makita
  - Inadequate safeguards at the working site
  - Deliberate dazzling of third parties
  - Controlling of machines, moving objects or similar monitoring applications without additional control and safety installations
- 

## 1.3

## Limits of Use

---

### Environment

Suitable for use in an atmosphere appropriate for permanent human habitation. Not suitable for use in aggressive or explosive environments.

---

### WARNING

#### **Working in hazardous areas or close to electrical installations or similar situations**

Life Risk.

#### **Precautions:**

- ▶ Local safety authorities and safety experts must be contacted by the person responsible for the product before working in such conditions.
- 

## 1.4

## Responsibilities

---

### Manufacturer of the product

Makita Corporation Anjo, 3-11-8, Sumiyoshi-cho, Aichi 446-8502, Japan  
Makita, Jan-Baptist Vinkstraat 2, 3070 Belgium

[www.makita.com](http://www.makita.com)

The company above is responsible for supplying the product, including the Instruction Manual in a completely safe condition.

The company above is not responsible for third-party accessories.

---

## Person responsible for the product

The person responsible for the product has the following duties:

- To understand the safety instructions on the product and the instructions in the User Manual
- To ensure that the product is used in accordance with the instructions
- To be familiar with local regulations relating to safety and accident prevention
- To stop operating the system and inform Makita immediately if the product and the application become unsafe
- To ensure that the national laws, regulations and conditions for the operation of the product are respected
- Always prevent access to the product by unauthorised personnel



The product is permitted to use for skilled persons only.

## 1.5

### Hazards of Use

#### NOTICE

#### Dropping, misusing, modifying, storing the product for long periods or transporting the product

Watch out for erroneous measurement results.

#### Precautions:

- ▶ Periodically carry out test measurements and perform the field adjustments indicated in the User Manual, particularly after the product has been subjected to abnormal use as well as before and after important measurements.

#### DANGER

#### Risk of electrocution

Because of the risk of electrocution, it is dangerous to use poles, levelling staffs and extensions in the vicinity of electrical installations such as power cables or electrical railways.

#### Precautions:

- ▶ Keep at a safe distance from electrical installations. If it is essential to work in this environment, first contact the safety authorities responsible for the electrical installations and follow their instructions.



 **WARNING****Lightning strike**

If the product is used with accessories, for example masts, staffs, poles, you may increase the risk of being struck by lightning.

**Precautions:**

- ▶ Do not use the product in a thunderstorm.

 **WARNING****Inadequate securing of the working site**

This can lead to dangerous situations, for example in traffic, on building sites and at industrial installations.

**Precautions:**

- ▶ Always ensure that the working site is adequately secured.
- ▶ Adhere to the regulations governing safety, accident prevention and road traffic.

 **CAUTION****Not properly secured accessories**

If the accessories used with the product are not properly secured and the product is subjected to mechanical shock, for example blows or falling, the product may be damaged or people can sustain injury.

**Precautions:**

- ▶ When setting up the product, make sure that the accessories are correctly adapted, fitted, secured, and locked in position.
- ▶ Avoid subjecting the product to mechanical stress.

 **WARNING****Inappropriate mechanical influences to batteries**

During the transport, shipping or disposal of batteries it is possible for inappropriate mechanical influences to constitute a fire hazard.

**Precautions:**

- ▶ Before shipping the product or disposing it, discharge the batteries by the product until they are flat.
- ▶ When transporting or shipping batteries, the person in charge of the product must ensure that the applicable national and international rules and regulations are observed.
- ▶ Before transportation or shipping, contact your local passenger or freight transport company.

 **WARNING**

**Distraction/loss of attention**

During dynamic applications, for example stakeout procedures, there is a danger of accidents occurring if the user does not pay attention to the environmental conditions around, for example obstacles, excavations or traffic.

**Precautions:**

- ▶ The person responsible for the product must make all users fully aware of the existing dangers.

 **WARNING**

**Unauthorised opening of the product**

Either of the following actions may cause you to receive an electric shock:

- Touching live components
- Using the product after incorrect attempts were made to carry out repairs

**Precautions:**

- ▶ Do not open the product!
- ▶ Only authorised Makita Service Centres are entitled to repair these products.

 **WARNING**

**Improper disposal**

If the product is improperly disposed of, the following can happen:

- If polymer parts are burnt, poisonous gases are produced which may impair health.
- If batteries are damaged or are heated strongly, they can explode and cause poisoning, burning, corrosion or environmental contamination.
- By disposing of the product irresponsibly you may enable unauthorised persons to use it in contravention of the regulations, exposing themselves and third parties to the risk of severe injury and rendering the environment liable to contamination.

**Precautions:**

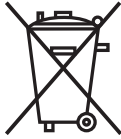
- ▶  The product must not be disposed with household waste.  
Dispose of the product appropriately in accordance with the national regulations in force in your country. Always prevent access to the product by unauthorised personnel.

Product-specific treatment and waste management information can be received from your Makita distributor.

 **WARNING**

**Improperly repaired equipment**

Risk of injuries to users and equipment destruction due to lack of repair knowledge.

**Precautions:**

- ▶ Only authorised Makita Service Centres are entitled to repair these products.
- 

 **WARNING**

**Exposure of batteries to high mechanical stress, high ambient temperatures or immersion into fluids**

This can cause leakage, fire or explosion of the batteries.

**Precautions:**

- ▶ Protect the batteries from mechanical influences and high ambient temperatures. Do not drop or immerse batteries into fluids.
- 

 **WARNING**

**Short circuit of battery terminals**

If battery terminals are short circuited e.g. by coming in contact with jewellery, keys, metallised paper or other metals, the battery can overheat and cause injury or fire, for example by storing or transporting in pockets.

**Precautions:**

- ▶ Make sure that the battery terminals do not come into contact with metallic/conductive objects.
- 

 **WARNING**

**Electric shock due to use under wet and severe conditions**

If unit becomes wet, it may cause you to receive an electric shock.

**Precautions:**

- ▶ If the product becomes humid, it must not be used!
- ▶ Use the product only in dry environments, for example in buildings or vehicles.



- ▶ Protect the product against humidity.
-

 **WARNING**

**Unauthorised opening of the product**

Either of the following actions may cause you to receive an electric shock:

- Touching live components
- Using the product after incorrect attempts were made to carry out repairs.

**Precautions:**

- ▶ Do not open the product!
  - ▶ Only authorised Makita Service Centres are entitled to repair these products.
- 

 **WARNING**

**Short circuit of battery terminals**

Risk of fire, electric shock and damage.

**Precautions:**

- ▶ Do not open the battery housing.
  - ▶ Keep away any metallic or wet objects from the battery terminals.
- 

 **WARNING**

**Magnetic field**

Magnets integrated in the target plate may affect the function of the pacemaker.

**Precautions:**

- ▶ Do not use the target plate near a pacemaker.
- 

 **WARNING**

**Battery pack of the signal transmitter may get hot after prolonged use**

Risk of burning injuries.

**Precautions:**

- ▶ Avoid touching the hot battery pack.
  - ▶ Allow the battery pack to cool down before removing it.
-

 **WARNING**

**Working with laser devices**

If the necessary measures for laser safety are not adopted, working with laser devices can be hazardous.

**Precautions:**

- ▶ Observe the User Manual of the respective laser device.
- ▶ Only use and operate the laser device as defined in the laser safety directions.

 **CAUTION**

**Laser beam**

Rotating lasers are safe for momentary exposures but can be hazardous for deliberate staring into the beam. The beam may cause dazzle, flash-blindness and after-images, particularly under low ambient light conditions. The goggles do not protect your eyes against the laser beam. They are only used to increase the visibility of the laser beam.

**Precautions:**

- ▶ Do not stare into the laser beam.

 **CAUTION**

**Battery tray not locked securely**

If the battery tray is not locked securely, it may fall out of the SKR001 accidentally and might cause damage and injury.

**Precautions:**

- ▶ Install and lock the battery tray securely.

 **CAUTION**

**Signal sound > 80 db(A)**

The A-weighted sound pressure level of the signal sound is > 80 db(A) at a distance of one metre. Your hearing may be damaged.

**Precautions:**

- ▶ Do not hold the device or the laser receiver directly to your ear.

 **CAUTION**

Rotating lasers are safe for momentary exposures but can be hazardous for deliberate staring into the beam. The beam may cause dazzle, flash-blindness and after-images, particularly under low ambient light conditions.

**Precautions:**

- ▶ Do not stare into the laser beam.

## NOTICE

### Misalignment of laser plane

Any misalignment of the laser plane will impact the grade of the work being done.

#### Precautions:

- ▶ Take care that the laser plane of the rotating laser is at the intended height.
- ▶ Take special care to protect the laser from impacts or bumps and make sure that the tripod is set on stable ground.

---

## 1.6 Laser Classification



---

### 1.6.1 General

---

#### General

The following chapters provide instructions and training information about laser safety according to international standard IEC 60825-1 (2014-05) and technical report IEC TR 60825-14:2022. The information enables the person responsible for the product and the person who actually uses the equipment, to anticipate and avoid operational hazards.

-  According to IEC TR 60825-14:2022, products classified as laser class 1, class 2 and class 3R do not require:
  - laser safety officer involvement
  - protective clothes and eyewear
  - special warning signs in the laser working areaif used and operated as defined in this User Manual due to the low eye hazard level.
-  National laws and local regulations could impose more stringent instructions for the safe use of lasers than IEC 60825-1 (2014-05) and IEC TR 60825-14:2022.

---

### 1.6.2 SKR001

---

#### General

The rotating laser built into the product produces a visible laser beam which emerges from the rotating head.

The laser product described in this section is classified as laser class 2 in accordance with:

- IEC 60825-1 (2014-05): "Safety of laser products"

These products are safe for momentary exposures but can be hazardous for deliberate staring into the beam. The beam may cause dazzle, flash-blindness and after-images, particularly under low ambient light conditions.

#### SKR001:

Description	Value
Maximum average radiant output power	< 1 mW
Pulse duration (effective)	c.w./1.1 ms
Pulse repetition frequency	c.w./10 Hz

Description	Value
Beam divergence	< 1.5 mrad
Wavelength	520 nm

### CAUTION

#### Class 2 laser product

From a safety perspective, class 2 laser products are not inherently safe for the eyes.

#### Precautions:

- ▶ Avoid staring into the beam or viewing it through optical instruments.
- ▶ Avoid pointing the beam at other people or at animals.
- ▶ Avoid pointing the beam at aircraft or any other vehicles at any distances.

## Labelling

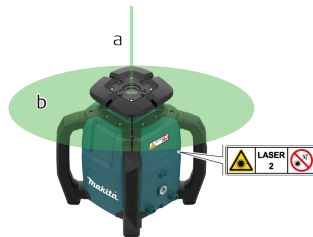

- a Stationary laser beam
- b Rotating laser beam

## 1.7

### Electromagnetic Compatibility (EMC)

#### Description

The term Electromagnetic Compatibility is taken to mean the capability of the product to function smoothly in an environment where electromagnetic radiation and electrostatic discharges are present, and without causing electromagnetic disturbances to other equipment.

### CAUTION

#### Electromagnetic radiation

Electric magnetic radiation can cause disturbances in other equipment.

#### Precautions:

- ▶ Although the product meets the strict regulations and standards which are in force in this respect, Makita cannot completely exclude the possibility that other equipment may be disturbed.

 **CAUTION****Intense electromagnetic radiation. For example, near radio transmitters, transponders, two-way radios or diesel generators**

Although the product meets the strict regulations and standards which are in force in this respect, Makita cannot completely exclude the possibility that the function of the product may be disturbed in such an electromagnetic environment.

**Precautions:**

- ▶ Check the plausibility of results obtained under these conditions.

 **CAUTION****Exceeding the RF radiation exposure limits for general population**

Health risk

**Precautions:**

- ▶ The antennas used for this transmitter must be installed such that a minimum separation distance of at least 23 cm is always maintained between the radiator (antenna) and all persons.
- ▶ The antennas used for this transmitter must not be co-located or operated with any other antenna or transmitter.

 **WARNING****Use of product with radio or digital cellular phone devices**

Electromagnetic fields can cause disturbances in other equipment, installations, medical devices, for example pacemakers or hearing aids, and aircrafts. Electromagnetic fields can also affect humans and animals.

**Precautions:**

- ▶ Although the product meets the strict regulations and standards which are in force in this respect, Makita cannot completely exclude the possibility that other equipment can be disturbed or that humans or animals can be affected.
- ▶ Do not operate the product with radio or digital cellular phone devices in the vicinity of filling stations or chemical installations, or in other areas where an explosion hazard exists.
- ▶ Do not operate the product with radio or digital cellular phone devices near medical equipment.
- ▶ Do not operate the product with radio or digital cellular phone devices in aircrafts.
- ▶ Do not operate the product with radio or digital cellular phone devices for long periods with the product immediately next to your body.

## 2 Description of the System

### 2.1 System Components

#### General description

The SKR001 is a laser tool for general construction and levelling applications such as

- Setting forms
- Checking grades
- Controlling depths for excavations

If set up within the self-levelling range, the SKR001 automatically levels to create an accurate horizontal or vertical plane of laser light. Once the SKR001 has levelled, the head will start rotating and the SKR001 is ready for use. 30 seconds after the SKR001 has completed the levelling, the H.I. Alert system becomes active and protects the SKR001 against changes in elevation caused by movement of the tripod to ensure accurate work.

#### Available system components

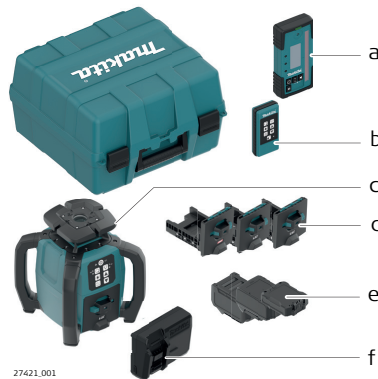

- |   |  |   |                     |
|---|--|---|---------------------|
| a | Digital receiver LDX2                  | e | Batteries: Optional |
| b | Remote control RC1                     | f | Charger: Optional   |
| c | Makita SKR001                          |   |                     |
| d | Battery tray: LXT<br>Optional: CXT/XGT |   |                     |



The delivered components depend on the package ordered.

## 2.2

## SKR001 Laser Components

SKR001 laser components

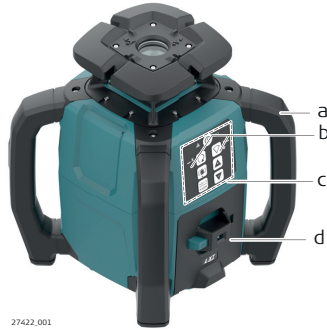

27422\_001

- a Carry Handle
- b LED Indicators
- c Buttons
- d Battery compartment

## 2.3

## Case Components

Case components - interior

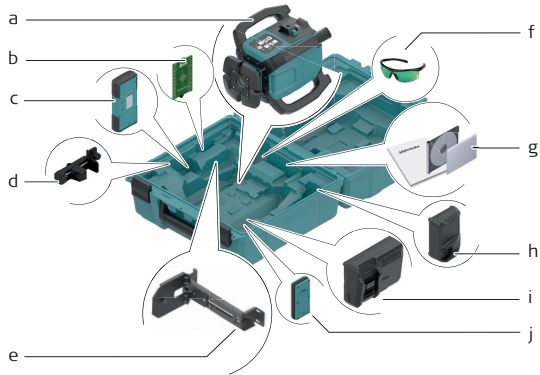

27423\_001

- a Makita SKR001
- b Target plate
- c Digital receiver LDX2
- d Bracket for Receiver
- e Wall mount
- f Laser visibility goggles
- g Documentation
- h Optional: Charger (LXT, XGT)
- i Optional: Charger (CXT)
- j Remote control RC1

## 2.4

## Setup

### Location

- Keep the location clear of possible obstructions that could block or reflect the laser beam.
- Place the SKR001 on stable ground. Ground vibration and extremely windy conditions can affect the operation of the SKR001.
- When working in a very dusty environment place the SKR001 up-wind so the dirt is blown away from the laser.

### Setting up on a Tripod

1. Set up the tripod.
2. Place the SKR001 on the tripod.
3. Tighten the screw on the underside of the tripod to secure the SKR001 on the tripod.



27424.001



- Attach the SKR001 securely to a tripod, or mount on a stable level surface.
- Always check the tripod before attaching the SKR001. Make sure all screws, bolts and nuts are tight.
- If a tripod has chains, they should be slightly loose to allow for thermal expansion during the day.
- Secure the tripod on extremely windy days.

# 3

## Operation

### 3.1

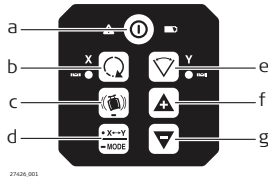

### Buttons

#### Buttons



- a Power
- b Head speed
- c H.I.Alert
- d Automatic/Manual Mode, select axis
- e Scan mode
- f Up
- g Down

#### Description of the buttons

Button	Function
Power	Press to turn SKR001 on or off. Both LED flash green until device is levelled - then solid.
Head speed	Press to change speed (in loop): Start is 600; 600/0/150/300/600 rpm Refer to <a href="#">Change the rotation speed, in loop</a> for details.
H.I.Alert	Long press H.I.Alert button to activate/deactivate H.I. Alert. Refer to <a href="#">Description of the H.I.Alert function</a> for details.
Automatic/Manual Mode, select axis	Single axis slope mode: Long press once to change the X-axis to manual mode with Y-axis self-levelling. Press again to change the Y-axis to manual mode with X-axis self-levelling.  Dual axis slope mode: Long press again to change both axes to manual mode with no self-levelling.  Long press again to change back to automatic mode.
	 Note the changes in the LED indicators in the manual modes. The red LED indicates that the corresponding axis is in manual mode.
Scan mode	Short press Scan button to activate scan mode. Short press Scan button to change angle (in loop): 30°/20°/10°. Refer to <a href="#">Change the scan angle, in loop</a> for details.   If scan mode is active, the X-axis LED and Y-axis LED indicators flash alternately orange and the previous colour (red or green).

Button	Function
Up/Down	Rotates the scan area or tilt the axis/laser beam depending on the operating mode.
	In Scan mode, it is not possible to tilt axes.



## 3.2

## LED Indicators

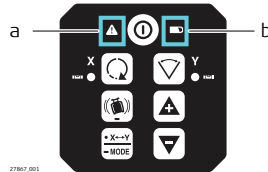
### Alert and Low Battery LED



- a Alert LED:  
H.I.Alert, servo, temperature
- b Low Battery indicator LED

LED	Status	Mode/function
Alert LED	Off	H.I.Alert off.
	Red: On	H.I.Alert triggered.
	Red: Slow flashing	Initialisation ~30 s.
	Red: Fast flashing, 2 Hz also X-axis LED and Y-axis LED are fast flashing	Alert indication.
Alert LED: <b>Servo limit alert</b>	Red: Fast flashing, 2 Hz and either X-axis LED or Y-axis LED, depending which axis is at limit	No levelling.
Alert LED: <b>Environment temperature alert</b>	Red: Fast flashing, 2 Hz	Alert is initiated, if: <ul style="list-style-type: none"> <li>• Temperature is <math>\geq 55\text{ }^{\circ}\text{C}</math></li> <li>• Temperature is <math>\leq -15\text{ }^{\circ}\text{C}</math></li> </ul> After 2 minutes in the alert condition, the unit shuts off automatically.
		In case temperature reaches operating temperature range again, the alert stops.
Indicator LED: <b>Low Battery</b>	Green: On	The battery is okay.
	Green: Fast flashing, 2 Hz	Low-battery.
		If low battery, the device changes to the head speed of 420 rpm. If receiver LDX2 is used, it shows the <b>Laser low battery warning</b> symbol. User can change to other speed or scan. Maximum is 420 rpm.

## X/Y-axis LED

The status of the X/Y-axis LED depend on the current function selected:

- Horizontal use.  
Refer to [3.6 Horizontal Use](#) for details
- Laydown use  
Refer to [3.7 Layout/Laydown Use](#) for details
- H.I.Alert  
Refer to [3.8 Height of Instrument Alert \(H.I.Alert\) function](#) for details
- Accuracy Adjustment  
Refer to [7 Accuracy Adjustment](#) for details

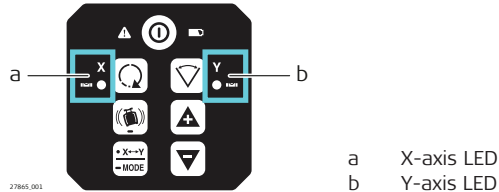

X/Y Colour	X/Y Status	Mode/Status
Green	Solid	Levelled/automatic.
Green	Slow flashing	Waiting to be levelled.
Red	Solid	Manual/not levelled.
Red	Slow flashing	Axis can be tilt with arrow buttons.
Red	Fast flashing, 2 Hz	ALARM indication: Device moved with H.I.Alert active.
Red	Fast flashing, both alternating	ALARM: Device in wrong laydown position.
Orange	Flashing	Device in scan mode.

## 3.3

### Turning the SKR001 On and Off

#### Description

Press the Power button to turn on or off the SKR001.



Device indicates turn on with short beep.

After turning on:

- If set up within the  $\pm 5^\circ$  self-levelling range (horizontal or vertical), the SKR001 automatically levels to create an accurate horizontal plane of laser light
- Once levelled, the head starts rotating and SKR001 is ready for use
- After 30 seconds of completing the levelling, the H.I.Alert system becomes active to protect the laser against changes in elevation caused by movement or settling of the tripod
- The self-levelling system and H.I.Alert function continues to monitor the position of the laser beam to ensure consistent and accurate work

### 3.4

## Automatic Mode

### Description of the Automatic Mode

The SKR001 always starts up in Automatic Mode. In Automatic Mode the SKR001 automatically levels if set up within the 5° self-levelling range (horizontal or laydown).

### Change the rotation speed, in loop

Push the Head speed button:

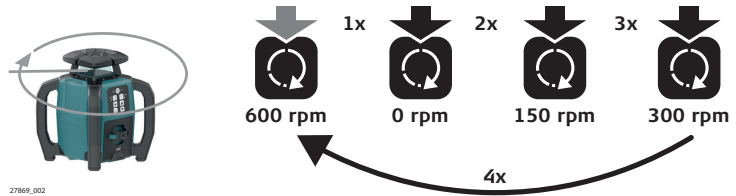

27869\_002



If rotation speed is set to 0, the head is not rotating and only a laser dot is visible.



The dot can only rotate by using up/down button horizontal use **AND** if SKR001 is in automatic mode!  
If device is in laydown mode, single slope or manual mode, the up/down buttons are to tilt axis and cannot rotate the dot!

### Change the scan angle, in loop

Push the Scan mode button:

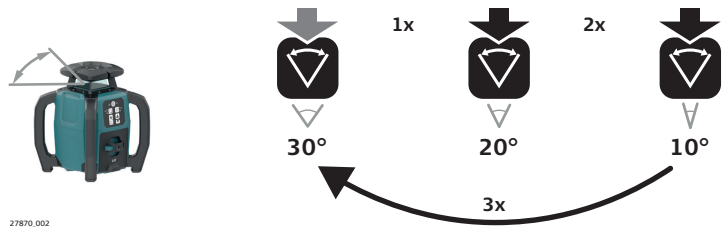

27870\_002

### 3.5

## Manual Mode

### Manual mode

After start-up the Manual Mode can be activated. In Manual Mode, the self-levelling is deactivated. The following options are available:

- Change the X-axis to Manual Mode/single axis slope mode
- Change the Y-axis to Manual Mode/single axis slope mode
- Change to Full Manual Mode/dual axis slope mode



After turning the SKR001 off and on again, the SKR001 is in Automatic Mode.

## Change the X/Y-axis to Manual Mode/single axis slope mode

### Changing the X-axis to single axis slope mode

1. After startup, long press the X/Y-Mode button to change the X-axis to single axis slope mode.



The X-axis and Y-axis are marked on the top of the SKR001.



28066\_001

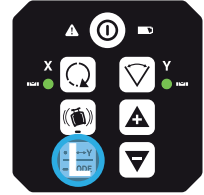

X-axis in single axis slope mode:

- The H.I.Alert LED is slow flashing red.
- The X-axis LED is slow flashing red.
- The Y-axis LED is green and continues to self-level.

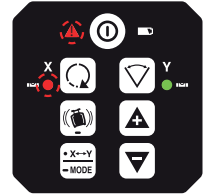

2. Press the Up/Down button to increment/decrement the slope for the X-axis.

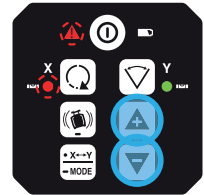

The slope of the X-axis moves upwards or downwards as illustrated.



27023\_001

### Changing the Y-axis to single axis slope mode

1. Press the X/Y-Mode button again to change the Y-axis to single axis slope mode.

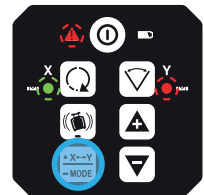



Y-axis in single axis slope mode:

- The H.I.Alert LED is slow flashing red.
- The Y-axis LED is slow flashing red.
- The X-axis LED is green and continues to self-level.

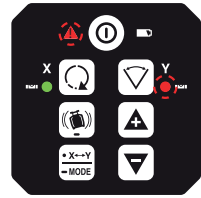

2. Press the Up/Down button to increment/decrement the slope for the Y-axis.

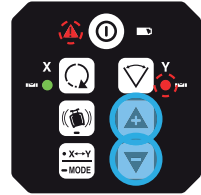

The slope of the Y-axis moves upwards or downwards as illustrated.



3. **Option:**  
Push the X/Y-Mode button to toggle between X-axis or Y-axis in single axis slope mode.

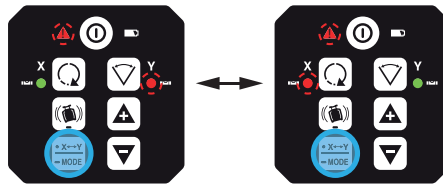

4. **Option:**  
Long push the X/Y-Mode button to switch to Dual Axis Slope Mode.

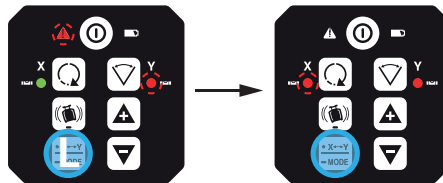

Refer to [Change to Full Manual Mode/dual axis slope mode](#) for details.



Long push the X/Y-Mode button to return to Automatic Mode.

### 3.6

## Horizontal Use

#### Description

Refer to chapter 5.1 up to chapter 5.4 for details.

### 3.7

## Layout/Laydown Use

#### Description

Refer to chapter 5.5 for details.

#### Laydown orientation detection



27976.001



When device is in normal laydown position, keypad upwards:

- X-axis LED is solid green, if levelled
- Y-axis LED flashes red, normal laydown



27977.001

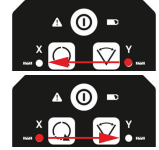

When device is in wrong laydown position, keypad sideways:

- X-axis LED and Y-axis LED flash at 2 Hz alternating to alert failure
  - Additional beep alarm
- This alert is same during normal use but also during calibration.

### 3.8

## Height of Instrument Alert (H.I.Alert) function

#### Description of the H.I.Alert function

- The H.I.Alert function prevents incorrect work caused by movement or settling of the tripod that would cause the laser to level at a lower height.
- The H.I.Alert function becomes active, 30 s after intialisation and level-ling of the SKR001. The H.I.Alert monitors the movement of the laser.
  - The alert LED is slow flashing during initialisation
  - Once levelled, the head of the laser starts rotating
  - If the H.I.Alert is active, the LED is fast flashing at 2 Hz
- The H.I.Alert monitors the laser. If disturbed, both the X-axis LED and Y-axis LED flash alternately together with the H.I.Alert LED. The SKR001 beeps rapidly.
- To stop the alert turn SKR001 off and on again. Check the height of the laser before beginning to work again.



The H.I.Alert function turns on automatically every time the SKR001 is turned on.

#### Disable/enable the H.I.Alert function

The H.I.Alert function can be disabled or enabled by pressing the following button combination:

1. If H.I.Alert is activated, long press the H.I.Alert button to deactivate.
2. To activate again, long press the H.I.Alert button.

**H.I.Alert indicator LED**

Initialisation (30 s):  
LED slow flashing 1 Hz



Armed/activated:  
LED solid



Alarm:  
Alert LED, red - fast flashing, 2 Hz and X-axis LED and Y-axis LED with a beep alarm.

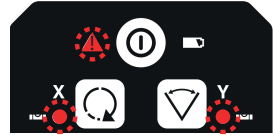

**Change to Full Manual Mode/dual axis slope mode**

**Changing to dual axis slope mode**

1. In Single Slope Mode, long press the X/Y-Mode button to enter the dual axis slope mode.

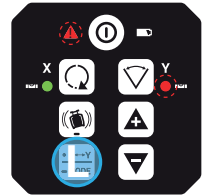

- Dual axis slope mode, X tilting, Y tilted:
- The H.I.Alert LED is OFF.
  - The X-axis LED is slow flashing red. No self-level.
  - The Y-axis LED is red. No self-level.

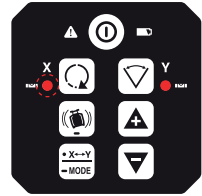

2. Press the Up/Down button to increment/decrement the slope for the X-axis.

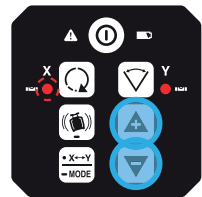

The slope of the X-axis moves upwards or downwards as illustrated.



3. **Option:**  
Press the X/Y-Mode button again to tilt the Y-axis.

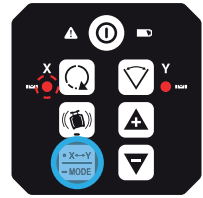

Dual axis slope mode, X tilted, Y tilting:

- The H.I.Alert LED is OFF.
- The X-axis LED is red. No self-level.
- The Y-axis LED is slow flashing red. No self-level.

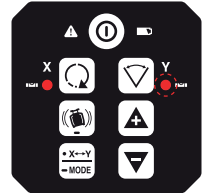

4. Press the Up/Down button to increment/decrement the slope for the Y-axis.

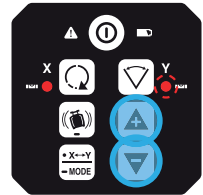

The slope of the Y-axis moves upwards or downwards as illustrated.



5. **Option:**  
Push the X/Y-Mode button to toggle between X-axis or Y-axis in dual axis slope mode.

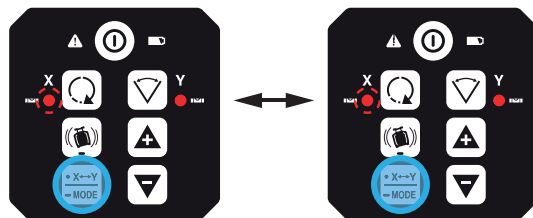

6. Long press the X/Y-Mode button to return to Automatic Mode.

### 3.9

## RC1 Remote Control

### Description

The RF Remote Control communicates with the SKR001 via RC (radio) and is used to control the same functions as on the laser.

### RC1 Remote Control panel

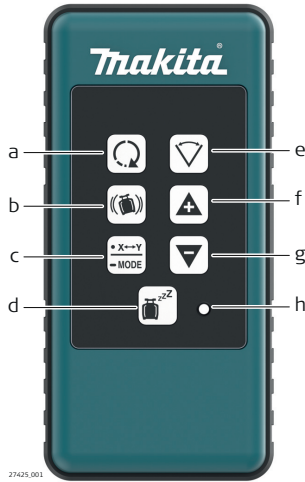

- a Head speed
- b H.I.Alert
- c Automatic/Manual Mode, select axis
- d Sleep mode
- e Scan mode
- f Up
- g Down
- h Sending LED

### Description of the buttons

Button	Function
Head speed	Press to change speed (in loop): 600 → 0/150/300/600 rpm Refer to <a href="#">Change the rotation speed, in loop</a> for details.
H.I.Alert	Long press H.I.Alert button to activate/deactivate H.I. Alert. Refer to <a href="#">Description of the H.I.Alert function</a> for details.
Automatic/Manual Mode, select axis	Single axis slope mode: Long press once to change the X-axis to manual mode with Y-axis self-levelling. Press again to change the Y-axis to manual mode with X-axis self-levelling.  Dual axis slope mode: Long press again to change both axes to manual mode with no self-levelling.  Long press again to change back to automatic mode.
	Note the changes in the LED indicators in the manual modes. The red LED indicates that the corresponding axis is in manual mode.

Button	Function
Sleep mode	<p>Press to put the SKR001 in sleep mode.</p> <ul style="list-style-type: none"> <li>• During Sleep Mode, all functions are disabled</li> <li>• The low battery indicator lights green or flashes green depending on battery power. All other LED are off</li> <li>• The SKR001 sleeps for 2 hours, then shuts down automatically and must be turned on again at the laser</li> <li>• When in Sleep Mode pressing the sleep button wakes the SKR001 and operation resumes same as before sleep mode</li> </ul>
Scan mode	<p>Short press Scan button to activate scan mode. Short press Scan button to change angle (in loop): 30° → 20°/10°/30°. Refer to <a href="#">Change the scan angle, in loop</a> for details.</p>
Up and Down	Rotates the scan area or tilt the axis/laser beam depending on the operating mode.

#### **Sending LED:**

The sending LED flashes to indicate that the remote is sending a signal to the SKR001.

### **3.9.1**

#### **Pairing the SKR001 with the RC1 Remote Control**

##### **Pairing step-by-step**

The SKR001 and the RC1 Remote Control include radio devices that allow the user to activate more functions on the SKR001.

When purchased together, the SKR001 and the RC1 have been paired together at the factory. Should it be necessary to pair your units after purchase, the following information is applicable.

Before using the RF features, the SKR001 and the Remote Control must first be paired together to be able to communicate with each other.

1. Turn off the SKR001.
2. Press and hold the Power button on the SKR001 to turn it on (5 sec).
3. Press and hold the Head Speed button and the Scan Mode button on the RC1.





The SKR001 beeps five times quickly and the X and Y LED indicators flash green when the pairing was successful.

**Changing the alkaline batteries, step-by-step**

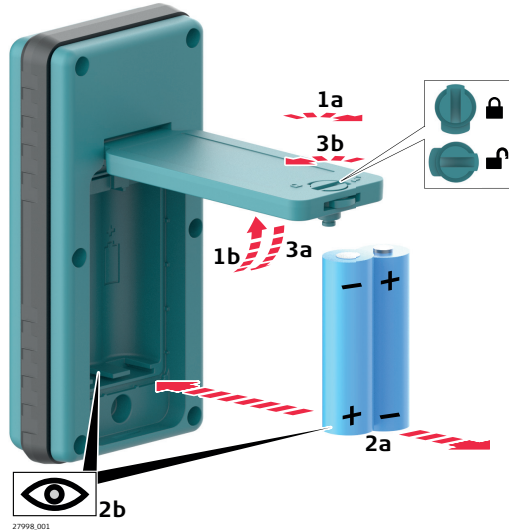
The LED flashes when the batteries are low.



Step	Description
	The batteries are inserted under the battery door.
1.	Turn the locking mechanism to the open position to open the battery door.
2.	Remove the batteries from the battery compartment.
	To insert the batteries: Insert the batteries into the battery compartment, ensuring that the contacts are facing in the right direction.
	The correct polarity is displayed inside the battery compartment.
3.	Close the cover of the battery compartment and turn the locking mechanism to the closed position to lock the battery door.

## 4

# LDX2 Digital Receiver

### Description

The SKR001 is sold with the LDX2 Digital Receiver.

### Instrument components, part 1 of 2

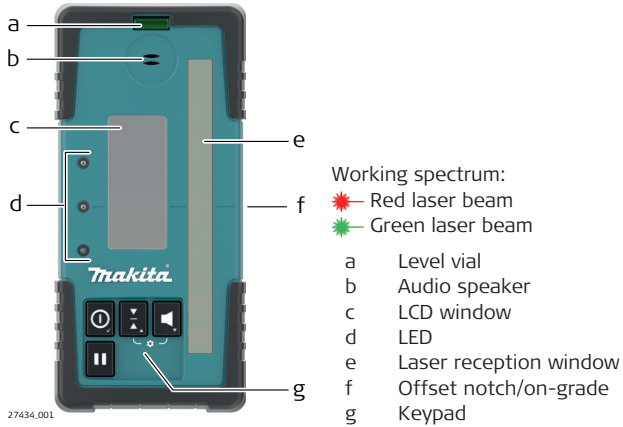

Component	Description
Level vial	Aids to keep the rod plumb when taking readings.
Audio Speaker	Indicates the position of the detector: <ul style="list-style-type: none"> <li>• High - Fast beeping</li> <li>• On-grade - Solid tone</li> <li>• Low - Slow beeping</li> </ul>
LCD window	Front and rear LCD arrow indicate the position of the receiver and numeric deviation of laser to offset notch/on-grade. Refer to <a href="#">Technical data</a> for details.
LEDs	Display the relative position of the laser beam. Three channel indication: <ul style="list-style-type: none"> <li>• High - Red</li> <li>• On-grade - Green</li> <li>• Low - Blue</li> </ul>
Laser Reception window	Detects the laser beam. The reception windows must be directed towards the laser.
Offset notch/on-grade	Indicates the on-grade position of the laser.
Keypad	Power, accuracy and volume functions. Refer to <a href="#">Description of the buttons</a> for detailed information.

**Instrument components, part 2 of 2**

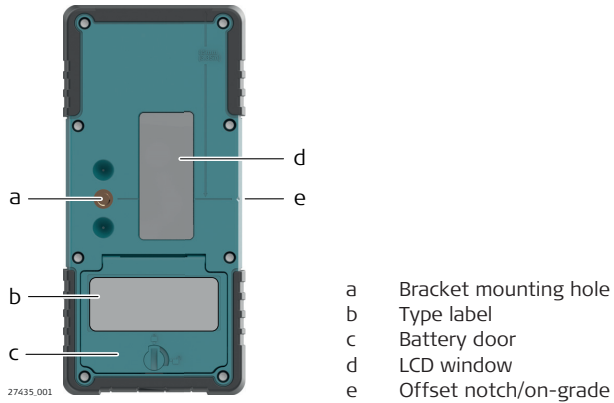

Component	Description
Bracket Mounting Hole	Location to attach the receiver bracket for normal operation.
Type label	The serial number is located inside the battery compartment.
Battery door	Access to the battery compartment.
LCD window	Front and rear LCD arrow indicate the position of the detector and numeric deviation of laser to Offset notch/on-grade.
Offset notch/on-grade	Use to transfer reference marks. The notch is 85 mm (3.35") below to top of the receiver.

**Description of the buttons**

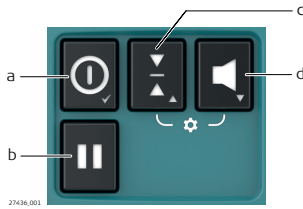

- a Power
- b Hold value
- c Sensitivity
- d Audio

Button	Function
Power	Press once to turn on the receiver.
Hold value	Press to capture digital reading.
Sensitivity	Press to change detection sensitivity.
Audio	Press to change the audio output.

**Hold value**

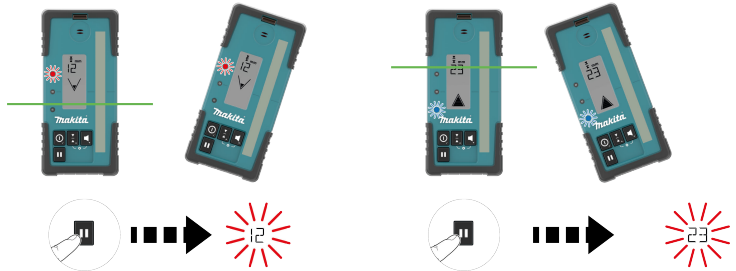





**Menu access and navigation**

To access the menu, press the Sensitivity button and Audio button simultaneously.

- Use the Sensitivity button and Audio button to change parameters.
- Use the Power button to scroll through the menu.

**Menu**

Menu	Function	Indication
UNT	Changes the unit of measure for the digital readout.	Units - mm/cm/in/ft  Active unit flashes.
LED	Changes the brightness of the LED indicators.	LEDs - High/Low/Off
DRO	Turns on or off the digital readout.	Green LED is on: digital readout is on. Red LED is on: digital readout is off.  DRO flashes.
BAT	Turns on or off the Laser low battery indication on the receiver.	Green LED is on: Laser low battery icon function is active. Red LED is on: Laser low battery icon function is not active.  SKR001 icon flashes.
MEM	Turns on or off the position memory function.	Green LED is on: function is on. Red LED is on: function is off.  Full down arrow flashes.
RPS	Measures the head speed of the laser.  Hold in rotating beam to measure the head speed.	Measured head speed is displayed.

**Special features**

Feature	Description
Strobe rejection	The RE Digital is designed to reject and eliminate unwanted signals from strobe lights.
Beam finding	Passing the RE Digital through the laser beam will cause the sensor to beep twice quickly.



Feature	Description
Out of beam display	If the receiver is moved out of the receiver range, the arrow display will indicate the direction to move to return to the laser beam.
Laser low battery	Alerts the user when the lasers's batteries are getting low.

### Changing the alkaline batteries, step-by-step

The small battery icon appears empty on the LDX2 display when the batteries are low and need replacement.

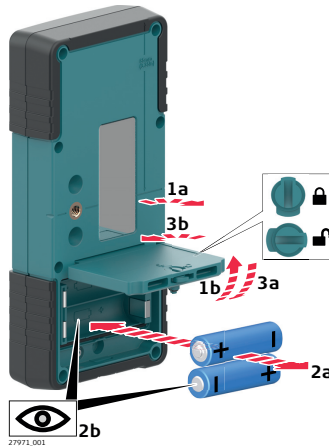

The batteries are inserted under the battery door.

1. Turn the locking mechanism to the open position to open the battery door.
2. Remove the batteries from the battery compartment.







To insert the batteries: Insert the batteries into the battery compartment, ensuring that the contacts are facing in the right direction.



The correct polarity is displayed inside the battery compartment.

3. Close the cover of the battery compartment and turn the locking mechanism to the closed position to lock the battery door.

## LCD Display

Icon	Description
	<p><b>Grade indication arrow</b> - seven channels are displayed for above and below grade.</p> <ul style="list-style-type: none"> <li>Arrow bars can be selected to represent the selected detection sensitivity.</li> <li>Memory Display - if the receiver is moved out of the detection range, the arrow display indicates the direction to move to return to the laser beam (see MEM in menu to enable/disable).</li> </ul>
	<p><b>Laser low battery warning</b> - the SKR001 icon is displayed when the battery of the laser unit is almost depleted. This feature is laser dependent (see BAT in menu to enable/disable).</p>
	<p><b>Audio volume indication</b> - four levels of volume are displayed: loud, medium, soft, off (no icon).</p>
<p>mm cm in ft</p>	<p><b>Units of measure</b> - five units of measure are displayed: mm (millimeter), cm (centimeters), in (inch), in (fractions), ft (feet).</p>
	<p><b>Elevation indication</b> - numeric value is displayed (dependent on the unit of measure chosen).</p>
	<p><b>Detection sensitivity</b> - five levels of accuracy are displayed: Very fine, Fine, medium, Coarse, Very coarse.</p>
	<p><b>Receiver low battery warning</b> - three levels of battery life are displayed: full, low, empty.</p>

## Receiver bracket

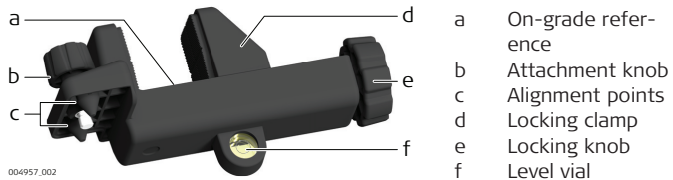

Component	Description
On-grade reference	The top edge of the bar aligns with the on-grade position.
Attachment knob	Attaches the clamp to the back of the receiver.
Alignment points	Aligns and secures the clamp.
Locking clamp	Holds the receiver and bracket to the grade rod.
Locking knob	Turn to tighten the locking clamp to the grade rod.
Level vial	The aids to keep the rod plumb when taking readings.

## 5 Applications

### 5.1 Setting Forms

#### Setting Forms, step by step

Application shown using the LDX2 Digital Receiver.

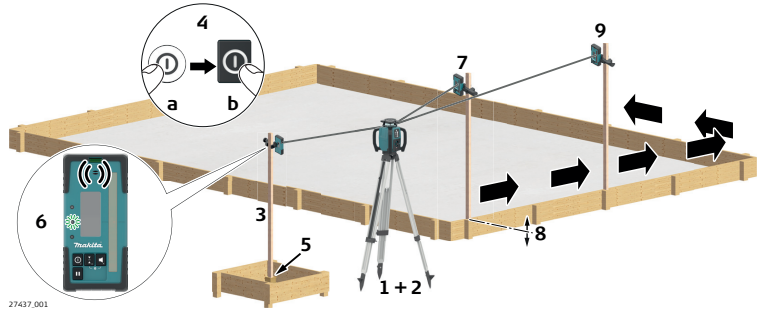

27437.001

1. Set up the SKR001 on a tripod.
2. Set up the tripod on a stable surface outside the working area.
3. Attach the receiver to a rod.
4. Turn on the SKR001 and the receiver.
5. Set the base of the rod on a known point for the finished height of forms.
6. Adjust the height of the receiver on the rod until the offset notch/on-grade position is indicated on the receiver by:
  - the centre bar
  - the green flashing LED
  - a solid audio tone
7. Set the rod with the attached receiver on top of the form.
8. Adjust the height of the form until the offset notch/on-grade position is again indicated.
9. Continue to more positions until the forms are levelled to the rotating plane of the SKR001.

## 5.2 Checking Grades

**Checking Grades, step-by-step** Application shown using the LDX2 Digital Receiver.

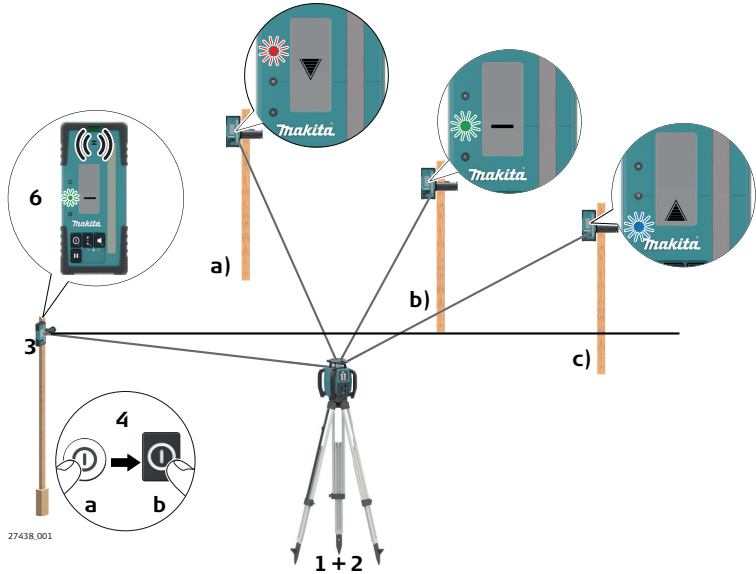

1. Set up the SKR001 on a tripod.
2. Set up the tripod on a stable surface outside the working area.
3. Attach the receiver to a rod.
4. Turn on the SKR001 and the receiver.
5. Set the base of the rod on a known point for the finished grade.
6. Adjust the height of the receiver on the rod until the offset notch/on-grade position is indicated on the receiver by:
  - The centre bar
  - The green flashing LED
  - A solid audio tone
7. Set the rod with the attached receiver on top of the excavation or concrete pour to check for correct elevation.
8. Variances can be read from the digital receiver.
  - a) Position is too high
  - b) Position is on grade
  - c) Position is too low

## 5.3

## Manual Grades

### Manual Grading, step by step

Application shown using the LDX2 Digital Receiver.

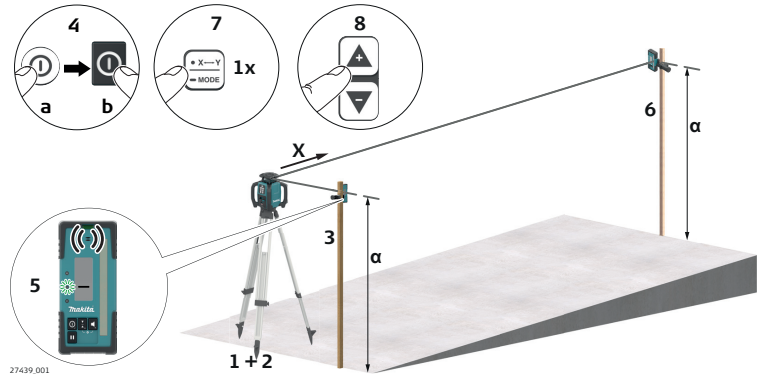

1. Set up the SKR001 on a tripod.
2. Set up the tripod at the base of a slope with the x-axis pointing in the direction of the slope.
3. Attach the receiver to a rod.
4. Turn on the SKR001 and the receiver.
5. At the base of the slope, adjust the height of the receiver on the rod until the offset notch/on-grade position is indicated on the receiver by:
  - the centre bar
  - the green flashing LED
  - a solid audio tone
6. Move the rod and the attached receiver to the top of the slope.
7. Change the X-axis to Manual Mode by long press the Auto-matic/Manual Mode button once on the SKR001.
8. Use the Left and Right Arrow buttons on the SKR001 to move the laser beam up and down until the offset notch/on-grade position is indicated on the receiver by:
  - the centre bar
  - the green flashing LED
  - a solid audio tone

## 5.4

# Suspended Ceilings

### Description

The SKR001 can also be used for suspended ceiling installations.

### Mounting the laser



1. Attach the SKR001 to the wall mount bracket.

### Application

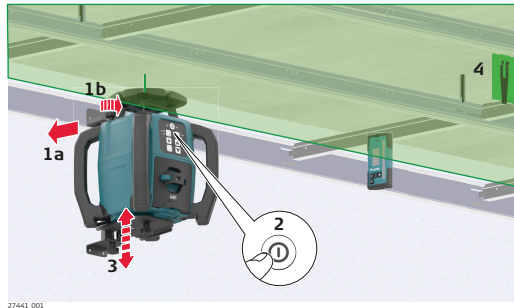

1. After mounting the first strip of ceiling trim at the desired height (centre position of the Target plate) below, attach the wall mount bracket and laser to the trim. Tighten the locking knobs on the top of the bracket.
2. Press the Power button to turn on the SKR001 and allow the SKR001 to self-level.
3. Adjust the SKR001 so that the rotating beam is at the desired height below the target plate. Loosen the adjustment knob on the side of the bracket and slide the SKR001 up or down. When at the desired height, retighten the adjustment knob.
4. Install the ceiling grid using the target plate and laser beam as your reference.

## Setup

Optional, use remote control to change scan or rotation for improved visibility:

- a Refer to [Change the scan angle, in loop](#) for details.
- b Refer to [Change the rotation speed, in loop](#) for details.

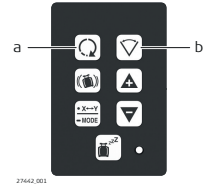

## 5.5

### Layout/Laydown Mode

#### Description

Lying on its side the SKR001 can be used for laying out wall positions, squaring, transferring points and more. Refer to [3.7 Layout/Laydown Use](#) for details.

#### Layout/Laydown

The SKR001 projects two laser beams at a 90° angle to each other.

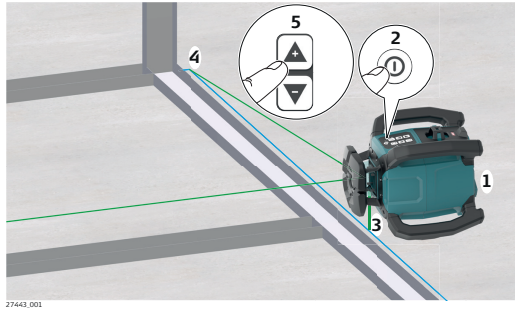

1. Place the SKR001 in the laydown position.
2. Press the power button to turn on the SKR001. The SKR001 always turns on in Automatic Mode which is in laydown like single slope mode. Allow the X-axis to self-level until X LED is solid green, levelled. Y LED flashes red as not levelled and can be adjusted.
3. In the laydown position, check the beam downwards for alignment over your reference.
4. Start the head rotation or scanning motion to roughly align the beam to a second control point. Refer to [Change the X/Y-axis to Manual Mode/single axis slope mode](#) for details.
5. Using the buttons on the laser or the remote control, fine adjust the beam until striking the second control point.
6. The rotating beam also creates a vertical plane for transferring points from the floor to the ceiling.

## Setup

In laydown position, use the Up and Down arrow button to quickly align the vertical plane or plumb beam to the second reference point.



27444\_001

## 5.6

### More Applications

---

#### More applications

#### Exterior Applications

- Setting elevation of forms and footings
- Squaring of forms
- Checking elevations and benchmarks
- Landscaping
- Drainage and septic systems
- Fences and retaining walls
- Decks and patios
- Simple driveways or small parking lots
- Facade Installations
- Batter board setups

#### Interior Applications

- Suspended ceilings
  - Walls and partitions
  - Vertical alignment
  - Transferring points from floor to ceiling
  - Vertical plumb
  - Layout of floors
  - Squaring of angles
  - Setting cabinets
  - Chair rails and wainscoting
  - Alignment of wall and floor tiles
  - Trim carpentry
  - Setting sprinkler head heights
  - Sloped ceilings
-

## 6

## Batteries

### Description

Operate the SKR001 with any Makita Li-Ion battery type LXT, CXT or XGT.

List the supported battery cartridge models:

- BL1015/BL1016/BL1020B/BL1021B/BL1040B/BL1041B/BL1050B
- BL1815N/BL1820/BL1820B/BL1830/BL1830B/BL1840/BL1840B/BL1850/BL1850B/BL1860B
- BL4020/BL4025/BL4040/BL4040F

Check the details of the model you have purchased.



Some of the battery cartridges may not be available depending on your region of residence.

### 6.1

### Operating Principles

#### First-time use/ charging batteries

- The battery must be charged before using it the first time, because it is delivered with an energy content as low as possible or might be in sleep mode.
- Charge the battery cartridge at room temperature at +10 °C to +40 °C / +50 °F to +104 °F. At cold temperature, charging may not start
- It is normal for the battery to become warm during charging. Using the chargers recommended by Makita, it is not possible to charge the battery once the temperature is too high
- For new batteries or batteries that have been stored for a long time (> three months), it is effectual to make a discharge/charge cycle
- For Li-Ion batteries, a single discharge/charge cycle is sufficient. We recommend carrying out the process when the battery capacity indicated on the charger or on a Makita product deviates significantly from the actual battery capacity available.

#### Operation/discharging

- The batteries can be operated from -20 °C to +55 °C / -4 °F to +131 °F
- Low operating temperatures reduce the capacity that can be drawn; high operating temperatures reduce the service life of the battery

### 6.2

### Battery for SKR001

#### Charging the Li-Ion battery pack, step-by-step

1. Remove the Makita battery from the SKR001.
2. Charge externally with original Makita charger.



#### Battery tray not locked securely

If the battery tray is not locked securely, it may fall out of the SKR001 accidentally and might cause damage and injury.

#### Precautions:

- ▶ Install and lock the battery tray securely.

**Installing or removing battery cartridge, step-by-step**

The Low Battery Indicator LED on the SKR001 flashes when the batteries are low and need to be charged. The charge indicator LED on the Lithium-Ion battery pack indicates when the pack is being charged (flashing slowly) or fully charged (on, not flashing).

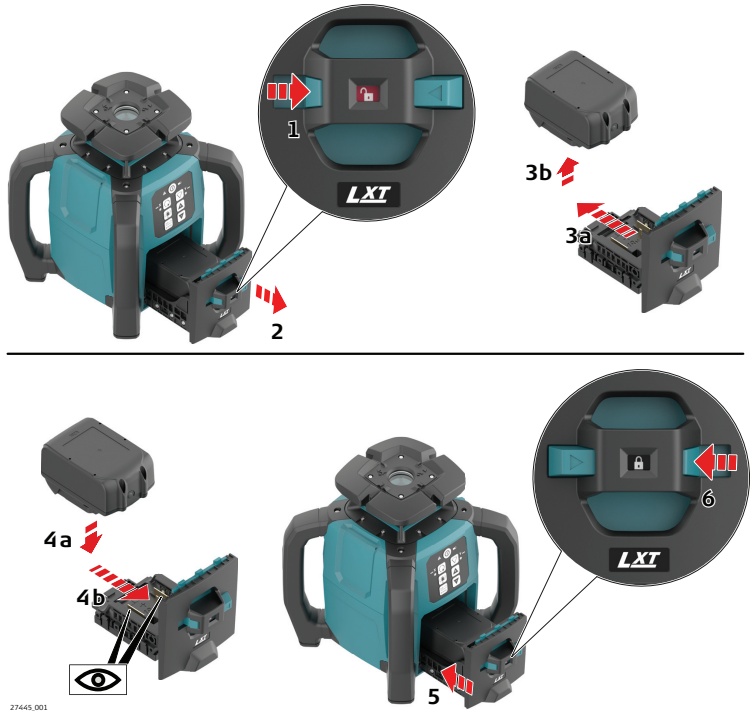

1. Always switch off the SKR001 before installing or removing of the battery tray.



Hold the tool and the battery tray firmly when installing or removing battery tray. Failure to hold the tool and the battery tray firmly may cause them to slip off your hands and result in damage to the tool and battery tray and a personal injury.

2. Slide the button (1) on the front of the battery tray to unlock position.  
To remove the battery tray, slide it out from the SKR001 (2).

3. Remove the battery cartridge from the battery tray (3).

4. Install the charged battery cartridge (4).  
To install the battery cartridge, align the tongue on the battery cartridge with the groove in the battery tray and slip it into place. Insert it all the way until it locks in place.



If you can see the red indicator on the upper side of the button, it is not locked completely.

5. Install the battery tray into the SKR001 (5).

---

6. Always slide the button (6) on the front of the battery tray to lock position and fully until the red indicator cannot be seen.  
 If not, it may accidentally fall out of the tool, causing injury to you or someone around you.

- 
-  Do not install the battery tray forcibly. If the battery tray does not slide in easily, it is not being inserted correctly or foreign object enters. Make sure that there is no foreign object inside and insert it correctly.
-

# 7

## Accuracy Adjustment

### About

- It is the responsibility of the user to follow operating instructions and to periodically check the accuracy of the laser and work as it progresses.
- The SKR001 is adjusted to the defined accuracy specification at the factory. It is recommended to check the laser for accuracy upon receipt and periodically thereafter to ensure accuracy is maintained. If the laser requires adjustment, contact your nearest authorised service centre or adjust the laser using the procedures described in this chapter.
- Only enter the accuracy adjustment mode when you plan to change the accuracy. Accuracy adjustments should only be performed by a qualified individual that understands basic adjustment principles.
- It is recommended to perform this procedure with two people on a relatively flat surface.

### 7.1

### Checking the Level Accuracy

#### Checking the level accuracy, step-by-step

1. Place the SKR001 on a flat, level surface or tripod approximately 30 m (100 ft) from a wall.

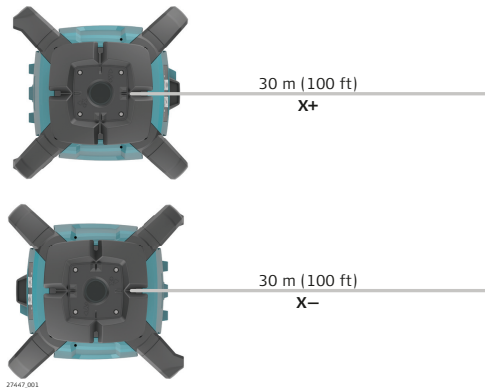

2. Align the first axis so that it is square to a wall. Allow the SKR001 to self-level completely (approximately 1 minute after the SKR001 begins to rotate).
3. Mark the position of the beam.
4. Rotate the laser 180° and allow it to self-level.
5. Mark the opposite side of the first axis.

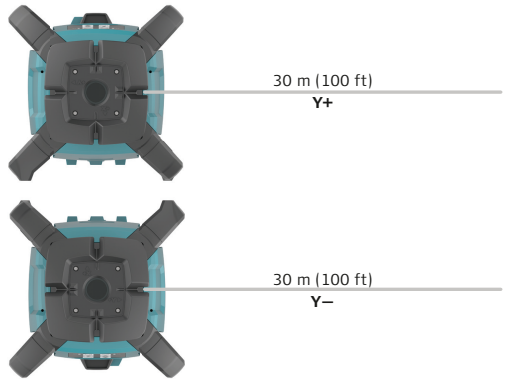

27448.001

6. Align the second axis of the SKR001 by rotating it 90° so that this axis is square to the wall. Allow the SKR001 to self-level completely.
7. Mark the position of the beam.
8. Rotate the laser 180° and allow it to self-level.
9. Mark the opposite side of the second axis.



If the four marks are within  $\pm 1.5$  mm from the centre, the SKR001 is within its accuracy specification

## 7.2 Adjusting the Self-Levelling Accuracy

### 7.2.1 Horizontal Position

#### Description

In Adjustment Mode the X-axis LED indicates changes to the X-axis.

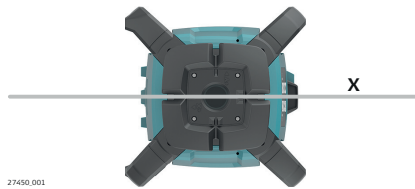

27450.001

The Y-axis LED indicates changes to the Y-axis.

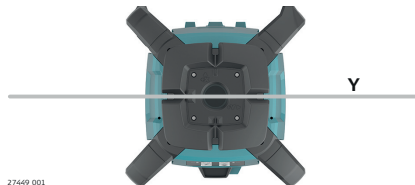

27449.001

**Entering adjustment mode for horizontal position, step-by-step**

1. Turn off the power.
2. Press and hold both the Up and Down arrow buttons.

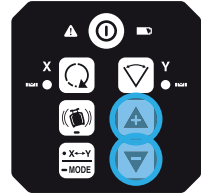

3. Press the Power button. The active axis is the X-axis.

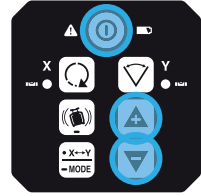

 The X-axis and the Y-axis LEDs flash alternately three times.

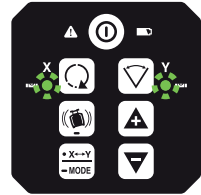

 The X-axis LED flashes three times, then flashes slowly until level. When the SKR001 is level, the X-axis LED is on, but does not flash.



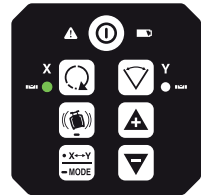

 The Y-axis LED is off

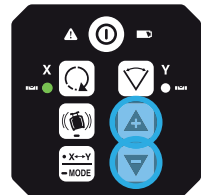

**Adjusting the X-axis, step-by-step**

1. Press the Up and Down arrow buttons to increment the vertical position of the laser beam.



 A flash of the X-axis LED and an audio beep indicate the change of an increment.

- Continue to press the Up and Down arrow buttons and monitor the spot until the SKR001 is within its specified range.



Five steps are equal to 15 arc seconds of change, or approximately 2.2 mm at 30 m (3/32" at 100 ft).

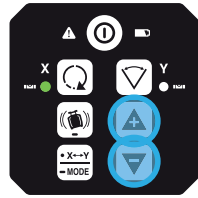

- Press the X/Y Mode button to change to Y-axis.

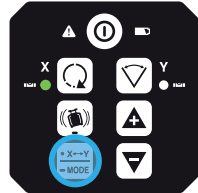

The X-axis and the Y-axis LEDs flash alternately three times.

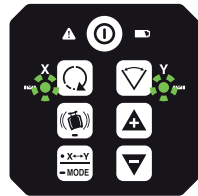

The Y-axis LED flashes three times, then flashes slowly until level. When the SKR001 is level, the Y-axis LED is on, but does not flash.



The X-axis LED is off.

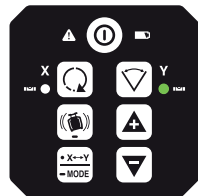

## Adjusting the Y-axis, step-by-step

- Press the Up and Down arrow buttons to increment the laser beam up and down.

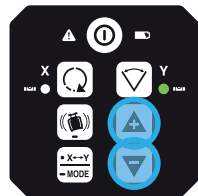

A flash of the Y-axis LED and an audio beep indicate the change of an increment.

2. Continue to press the Up and Down arrow buttons and monitor the spot until the SKR001 is within its specified range.



Five steps are equal to 15 arc seconds of change, or approximately 2.2 mm at 30 m (3/32" at 100 ft).

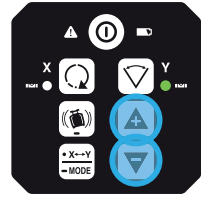

Press the X/Y Mode button to switch back to the X-axis if desired.

3. Press and hold the X/Y Mode button for 3 seconds to save and exit the Adjustment Mode.

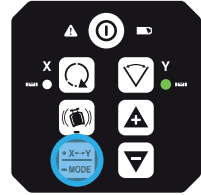

The X-axis LED and Y-axis LED flash alternately three times.

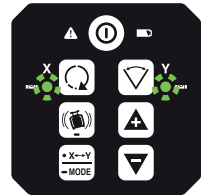

The SKR001 shuts off.

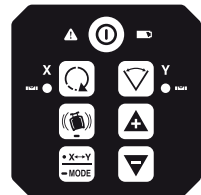

Pressing the Power button at any time while in Adjustment Mode will exit the mode without saving changes.

## 7.2.2

## Layoutdown Position

### Laydown orientation detection



27976\_001

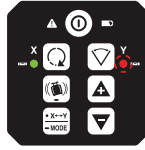

When device is in normal laydown position, keypad upwards:

- X-axis LED is solid green, if levelled
- Y-axis LED flashes red, normal laydown



27977\_001

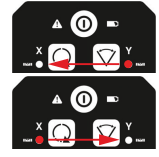

When device is in wrong laydown position, keypad sideways:

- X-axis LED and Y-axis LED flash at 2 Hz alternating to alert failure
- Additional beep alarm

This alert is same during normal use but also during calibration.

### Entering adjustment mode for laydown position, step-by-step

1. Turn off the power.
2. Place the SKR001 in the laydown position.
3. With power off, press and hold both the Up and Down arrow buttons.

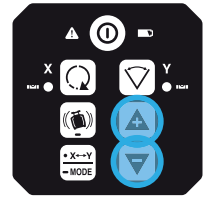

4. Press the Power button. The active axis is the X-axis.

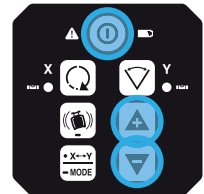

The X-axis and the Y-axis LEDs flash alternately three times.

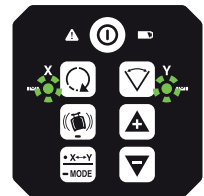

The X-axis LED flashes three times, then flashes slowly until level. When the SKR001 is level, the X-axis LED is on, but does not flash.



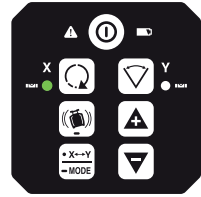

 The Y-axis LED is off.

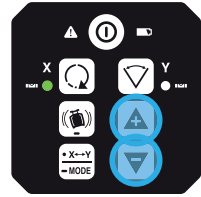

### Adjusting the lay-down position, step-by-step

1. Press the Up and Down arrow buttons to increment the vertical position of the laser beam.



 A flash of the X-axis LED and an audio beep indicate the change of an increment.

2. Continue to press the Up and Down arrow buttons and monitor the spot until the SKR001 is within its specified range.

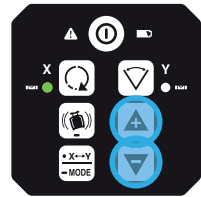

### Exiting adjustment mode

1. Press and hold the X/Y Mode button for 3 seconds to save and exit the Adjustment Mode.

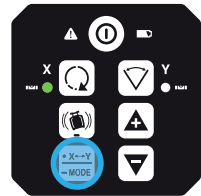

 The X-axis LED and Y-axis LED flash alternately three times.

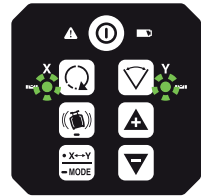

 The SKR001 shuts off.









---

Pressing the Power button at any time while in Adjustment Mode will exit the mode without saving changes.

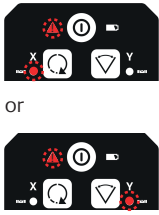
---

## Alerts

Alert	Symptom	Possible causes and solutions
	<b>Low Battery</b> LED flashes green.	The batteries are low. Replace the Li-Ion battery pack. Refer to <a href="#">6 Batteries</a> .
	<b>Elevation (H.I.Alert)</b> Alert LED, red - fast flashing, 2 Hz and X-axis LED and Y-axis LED with a beep alarm.	The SKR001 has been bumped or tripod was moved. Turn off SKR001 to stop alert check the height of the laser before beginning to work again. Allow SKR001 to relevel and check the height of the laser. After 2 minutes in the alert condition, the unit will shut off automatically.
 or 	<b>Servo Limit Alert</b> Alert LED, red - fast flashing, 2 Hz and either X-axis LED or Y-axis LED, depending on the axis which is at limit.	The SKR001 is tipped too far to reach a level position. Relevel the SKR001 within the 5 degree self-levelling range. This alert is also displayed any time the unit is tipped more than 5° from level. After 2 minutes in the alert condition, the unit will shut off automatically.
	<b>Environment Temperature Alert</b> Alert LED, red - fast flashing, 2 Hz	The SKR001 is in an environment where it cannot operate without damaging the laser diode. This damage could be a result of heat from direct sunlight. Shade the SKR001 from the sun. After 2 minutes in the alert condition, the unit shuts off automatically.   In case temperature reaches operating temperature range again, the alert stops.  Alert is initiated, if: <ul style="list-style-type: none"> <li>• Temperature is <math>\geq 55\text{ }^{\circ}\text{C}</math></li> <li>• Temperature is <math>\leq -15\text{ }^{\circ}\text{C}</math></li> </ul>

## Troubleshooting

Problem	Possible Cause(s)	Suggested Solutions
The SKR001 is working, but not self-levelling.	The SKR001 is in Manual Mode.	The SKR001 must be in Automatic Mode to self-level. Set the SKR001 to Automatic Mode by pressing the Automatic/Manual Mode button. <ul style="list-style-type: none"> <li>- In Automatic Mode the X-axis LED and the Y-axis LED flash green while levelling.</li> <li>- In Manual Mode the X-axis LED and/or the Y-axis LED are red.</li> </ul>
SKR001 does not turn on.	The batteries are low or dead.	Check the batteries and change or charge the batteries if necessary. If the problem continues, return the SKR001 to an authorised service centre for service.
The distance of the laser is reduced.	Dirt is reducing the laser output.	Clean the windows of the SKR001 and the receiver. If the problem continues, return the SKR001 to an authorised service centre for service.
The laser receiver is not working properly.	The SKR001 is not rotating. It may be levelling or in Elevation Alert.	Check for proper operation of the SKR001.  Refer to the receiver manual for more information.
	The receiver is out of usable range.	Move closer to the SKR001.
	The batteries of the receiver are low.	Change the receiver batteries.
The SKR001 cannot communicate with the RC1 Remote Control.	The SKR001 and the remote control have not been paired and cannot communicate with each other.	Pair the SKR001 and the remote control. Refer to <a href="#">3.9.1 Pairing the SKR001 with the RC1 Remote Control</a> for more information.
H.I.Alert function is not working.	The H.I.Alert function is disabled.	The H.I.Alert function is enabled by long press of the H.I.Alert button. Refer to <a href="#">3.8 Height of Instrument Alert (H.I.Alert) function</a> for details.

<b>Problem</b>	<b>Possible Cause(s)</b>	<b>Suggested Solutions</b>
The SKR001 does not turn on in Automatic Mode.	The SKR001 is designed to always turn on in Automatic Mode unless specifically disabled by the user.	The Automatic Mode can be enabled or disabled by pressing the Automatic/Manual Mode button.
The SKR001 is on, but laser is not rotating.	Rotation speed may be set to 0 and/or dot is not within visible range.	Change rotation speed or turn SKR001 off and on again.

## 9 Care and Transport

---

### 9.1 Transport

---

<b>On-site transport</b>	<p>When transporting the equipment in the field, always make sure that you</p> <ul style="list-style-type: none"><li>• either carry the product in its original container,</li><li>• or carry the tripod with its legs splayed across your shoulder, keeping the attached product upright.</li></ul>
<b>Transport in a road vehicle</b>	<p>Never carry the product loose in a road vehicle, as it can be affected by shock and vibration. Always carry the product in its container and secure it.</p>
<b>Shipping</b>	<p>When transporting the product by rail, air or sea, always use the complete original Makita packaging, container and cardboard box, or its equivalent, to protect against shock and vibration.</p>
<b>Shipping, transport of batteries</b>	<p>When transporting or shipping batteries, the person responsible for the product must ensure that the applicable national and international rules and regulations are observed. Before transportation or shipping, contact your local passenger or freight transport company.</p>
<b>Field adjustment</b>	<p>Exposing the product to high mechanical forces, for example through frequent transport or rough handling, or storing the product for a long time may cause deviations and a decrease in the measurement accuracy. Periodically carry out test measurements and perform the field adjustments indicated in the User Manual before using the product.</p>

---

### 9.2 Storage

---

<b>Product</b>	<p>Respect the temperature limits when storing the equipment, particularly in summer if the equipment is inside a vehicle. Refer to <a href="#">10 Technical Data</a> for information about temperature limits.</p>
<b>Li-Ion and alkaline batteries</b>	<p><b>For Li-Ion and alkaline batteries</b></p> <ul style="list-style-type: none"><li>• Refer to <a href="#">10 Technical Data</a> for information about storage temperature range</li><li>• Remove batteries from the product and the charger before storing</li><li>• After storage recharge batteries before using</li><li>• Protect batteries from damp and wetness. Wet or damp batteries must be dried before storing or use</li></ul>

#### For Li-Ion batteries

- A storage temperature range of 0 °C to +30 °C / +32 °F to +86 °F in a dry environment is recommended to minimize self-discharging of the battery
- At the recommended storage temperature range, batteries containing a 40% to 50% charge can be stored for up to one year. After this storage period the batteries must be recharged

---

## 9.3

### Cleaning and Drying

---

#### Product and accessories

- Blow dust off lenses and prisms.
- Never touch the glass with your fingers.
- Use only a clean, soft, lint-free cloth for cleaning. If necessary, moisten the cloth with water or pure alcohol. Do not use other liquids; these may attack the polymer components.

---

#### Damp products

Dry the product, the transport container, the foam inserts and the accessories at a temperature not greater than 40 °C/104 °F and clean them. Remove the battery cover and dry the battery compartment. Do not repack until everything is completely dry. Always close the transport container when using in the field.

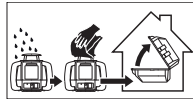

---

#### Cables and plugs

Keep plugs clean and dry. Blow away any dirt lodged in the plugs of the connecting cables.

---

# 10

# Technical Data

## 10.1

## Conformity to National Regulations

### 10.1.1

### SKR001

#### Labelling SKR001

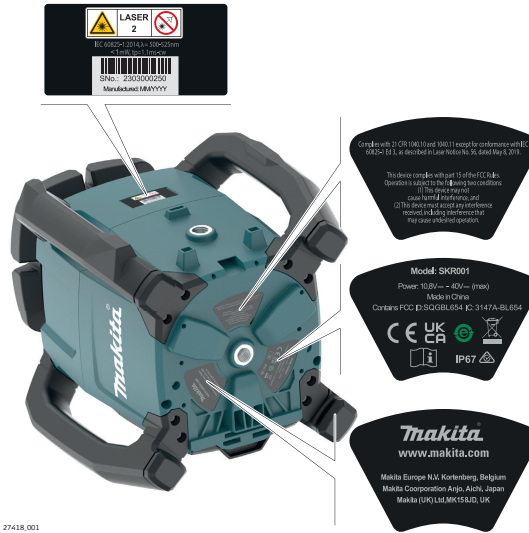

27418\_001

<b>Antenna</b>	SKR001:	Chip antenna
<b>Frequency band</b>	2400 - 2483.5 MHz	
<b>Output power</b>	< 100 mW (e. i. r. p.)	
<b>EU</b>		Hereby, Makita declares that the radio equipment type SKR001 is in compliance with Directive 2014/53/EU and other applicable European Directives.
<b>USA</b>	FCC Part 15	

This equipment has been tested and found to comply with the limits for a Class B digital device, pursuant to part 15 of the FCC Rules.

These limits are designed to provide reasonable protection against harmful interference in a residential installation.



This equipment generates, uses, and can radiate radio frequency energy and, if not installed and used in accordance with the instructions, it may cause harmful interference to radio communications.

However, there is no guarantee that interference does not occur in a particular installation.

If this equipment does cause harmful interference to radio or television reception, which can be determined by turning the equipment off and on, the user is encouraged to try to correct the interference by one or more of the following measures:

- Reorient or relocate the receiving antenna.
- Increase the separation between the equipment and the receiver.
- Connect the equipment into an outlet on a circuit different from that to which the receiver is connected.
- Consult the dealer or an experienced radio/TV technician for help.

---

Changes or modifications not expressly approved by Makita for compliance could void the user's authority to operate the equipment.

---

## Canada

CAN ICES-003 B/NMB-003 B

---

### Canada Compliance Statement

This device contains licence-exempt transmitter(s)/receiver(s) that comply with Innovation, Science and Economic Development Canada's licence-exempt RSS(s). Operation is subject to the following two conditions:

1. This device may not cause interference
2. This device must accept any interference, including interference that may cause undesired operation of the device

### Canada Déclaration de Conformité

L'émetteur/récepteur exempt de licence contenu dans le présent appareil est conforme aux CNR d'Innovation, Sciences et Développement économique Canada applicables aux appareils radio exempts de licence. L'exploitation est autorisée aux deux conditions suivantes:

1. L'appareil ne doit pas produire de brouillage
2. L'appareil doit accepter tout brouillage radioélectrique subi, même si le brouillage est susceptible d'en compromettre le fonctionnement du dispositif

## Others

The conformity for countries with other national regulations has to be approved prior to use and operation.

---

## 10.1.2

## RC1 Remote Control

### Labelling RC1



27420\_001



### Antenna

RC1:

Chip antenna

### Frequency band

2400 - 2483.5 MHz

### Output power

< 100 mW (e. i. r. p.)

### EU



Hereby, Makita declares that the radio equipment type RC1 is in compliance with Directive 2014/53/EU and other applicable European Directives.

### USA

FCC Part 15

### Others

The conformity for countries with other national regulations has to be approved prior to use and operation.

## 10.1.3

## LDX2 Digital Receiver

### Labelling LDX2

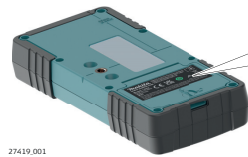

27419\_001



### EU



Hereby, Makita declares that the radio equipment type LDX2 is in compliance with Directive 2014/53/EU and other applicable European Directives.

### USA

FCC Part 15

### Others

The conformity for countries with other national regulations has to be approved prior to use and operation.

## 10.2 General Technical Data of the Product

### 10.2.1 SKR001

**Operating range** Radius: 400 m/1300 ft

**Self-levelling accuracy** Horizontal ±0.5 mm/10 m  
Vertical ±0.75 mm/10 m

Severe temperature fluctuations, humidity, impacts, and falls can affect accuracy. Check accuracy before making important measurements.

Refer to [7.1 Checking the Level Accuracy](#) for details.

#### Self-levelling range

Type	Value
Self-levelling range	±5°

#### Rotation speed

Rotation speed: 0/150/300/600 rpm  
0/2.5/5/10 rps

#### Scanning modes

Scanning modes: 30°/20°/10°

#### Laser dimensions

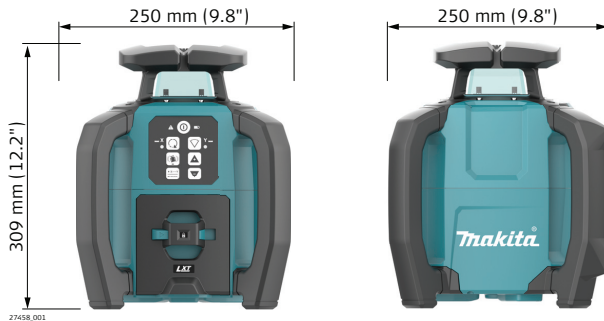

#### Weight

SKR001 weight without battery: 4.0 kg/8.8 lbs.

#### Battery cartridge

Type	Operating times <sup>1)</sup> for SKR001 at 20 °C
BL1040B	55 h
BL1860B	135 h
BL4040	160 h

<sup>1)</sup> Operating times are dependent upon environmental conditions.

**Environmental specifications**

**Temperature**

Operating temperature	Storage temperature
-10 °C to +50 °C (14 °F to +122 °F)	-20 °C to +70 °C (-4 °F to +158 °F)

**Protection against water, dust and sand**

Type	Protection
SKR001	IP67 (IEC 60529)
	Dust tight Protected against continuous immersion in water.
Battery compartment	IP66

**10.2.2**

**RC1 Remote Control**

**Operating range**

Radius: 100 m/328 ft

**Environmental specifications**

**Protection against water, dust and sand**

Protection
IP65 (IEC 60529)

**Batteries**

Type	Value
Batteries	2 × 1.5 V AA
Battery life, typical usage	70 hours

**Remote control dimensions**

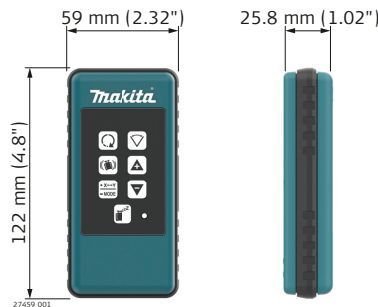

## 10.2.3

## LDX2 Digital Receiver

<b>Technical data</b>	Working diameter (laser dependent)	800 m/2625 ft
	Digital readout up to	200 m/656 ft
	Detection height	120 mm/5 in
	Numeric readout height	90 mm/3.5 in
	Detectable spectrum	Green laser: 500-570 nm Red laser: 600-800 nm
	Detection sensitivity	
	Very fine	±0.5 mm/±0.02 in
	Fine	±1.0 mm/±0.04 in
	Medium	±2.0 mm/±0.08 in
	Coarse	±3.0 mm/±0.12 in
	Very coarse	±5.0 mm/±0.20 in
	Audio volumes	105 dBA/95 dBA/65dBA/Off
	Automatic shut off	10 minutes
	Digital readout - units	mm, cm, in, in (fractions), ft
	Arrow display - channels	15 channels
	Anti-strobe protection	Yes
	Memory, last beam strike	Yes
	Beam finding (double beep)	Yes
	Laser low battery indicator	Yes
	Batteries	2 × 1.5 V AA
Battery life, typical usage	50 hours	

### Environmental specifications

#### Temperature

Operating temperature	Storage temperature
-20 °C to +50 °C	-40 °C to +70 °C
-4 °F to +122 °F	-40 °F to +158 °F

#### Protection against water, dust and sand

Type	Protection
LDX2	IP67 (IEC 60529)
	Dust tight Protected against continuous immersion in water.
Battery compartment	IP65

## Dimensions

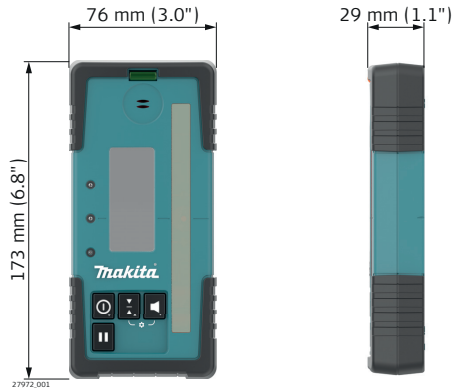

## 10.3

### Dangerous Goods Regulations

#### Dangerous Goods Regulations

Many products of Makita are powered by Lithium batteries.

Lithium batteries can be dangerous under certain conditions and can pose a safety hazard. In certain conditions, Lithium batteries can overheat and ignite.



When carrying or shipping your Makita product with Lithium batteries onboard a commercial aircraft, you must do so in accordance with the **IATA Dangerous Goods Regulations**.



There are guidelines on **How to carry** and **How to ship** products with Lithium batteries. Before any transportation of a Makita product, we ask you to consult the guidelines on the web page ([IATA Lithium Batteries](#)) to ensure that you are in accordance with the IATA Dangerous Goods Regulations and that the Makita products can be transported correctly.



Damaged or defective batteries are prohibited from being carried or transported onboard any aircraft. Therefore, ensure that the condition of any battery is safe for transportation.

# 11

## Accessories

---

### Accessories for power supply



LXT Batteries



CXT Batteries



XGT Batteries  
Capacity: 4 Ah or less



Battery tray for CXT



Battery tray for XGT

27460.002



**993612-1.1.0en**

Original text (993612-1.1.0en)

**Makita Corporation**

3-11-8, Sumiyoshi-cho,  
Anjo, Aichi 446-8502 Japan

**Makita Europe N. V.**

Jan-Baptist Vinkstraat 2  
3070 Kortenberg, Belgium

**Makita UK Ltd**

MK15 8JD, United Kingdom

[www.makita.com](http://www.makita.com)