

Midea Cooker Hood Instructions

MODEL: MHC60SS
MHC90SS



SAVE THESE INSTRUCTIONS CAREFULLY

Read the instructions carefully before using your cooker hood, and keep them carefully.
If you follow the instructions, your cooker hood will serve you many years well.

RECOMMENDATIONS AND SUGGESTIONS

 The instructions apply to several versions of this appliance. Accordingly, you may find descriptions of individual features that do not apply to your appliance.

INSTALLATION

- The manufacturer will not be held liable for any damages resulting from incorrect or improper installation.
- The minimum distance between the supporting surface for the cooking vessels on the hob and the lowest part of the cooker hood. (When the cooker hood is located above a gas appliance, the distance shall be at least 65 cm. If the installation instructions for the gas hob specify a greater distance, it has to be taken into account. The distance of 65 cm can be reduced for non-combustible parts of the cooker hood and parts operating at safety extra low voltage, provided these parts do not give access to live parts if deformed.)
- Check that the mains voltage corresponds to that indicated on the rating plate fixed to the inside of the hood.
- For Class I appliances, check that the domestic power supply guarantees adequate earthing.
- Connect the extractor to the exhaust flue through a pipe with the minimum diameter of 120 mm.
- The route of the flue must be as short as possible.
- The air must not be discharged into a flue that is used for exhausting fumes from appliances, burning gas or other fuels.
- If the extractor is used in conjunction with non-electrical appliances (e.g. gas burning appliances), a sufficient degree of aeration must be guaranteed in the room in order to prevent backflow of the exhaust gas. The kitchen must have an opening communicating directly with the open air in order to guarantee the entry of clean air.
- When the cooker hood is used in conjunction with appliances supplied with energy other than electric, the negative pressure in the room must not exceed 0.04 mbar to prevent fumes being drawn back into the room by the cooker hood.
- If the supply cord is damaged, it must be replaced by the manufacturer, its service agent or similarly qualified persons in order to avoid a hazard.
- Regulations concerning the discharge of air have to be fulfilled.

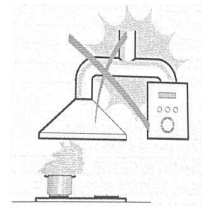

USE

- The cooker hood is only for home use, not suitable for barbecue, roast shop and other commercial purposes.
- Never use the hood for purposes other than those intended.
- Never leave high naked flames under the hood when it is in operation.
- Adjust the flame intensity to direct the flame up to the bottom of a pan only, making sure that it does not engulf the sides.
- Deep fat fryers must be continuously monitored during use: overheated oil can burst into flames.
- Do not flame under the cooker hood, with a risk of fire.
- This appliance can be used by children aged 8 and above and persons with reduced physical, sensory or mental capabilities or lacking experience and knowledge if they have been given supervision or instruction concerning use of the appliance in a safe way and understood the hazards involved.
- Children should be supervised to ensure that they do not play with the appliance.
- Cleaning and maintenance shall not be made by children without supervision.
- "CAUTION: Accessible parts may become hot when used with cooking appliances".

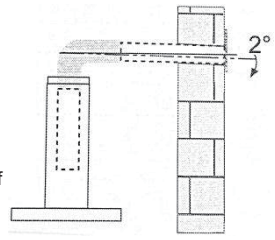

MAINTENANCE

- The cooker hood and its filter should be cleaned regularly according to the instructions.
- Switch off or unplug the appliance from the mains supply before carrying out any maintenance work.
- Clean and/or replace the filters after the specified period (fire hazard).
- Clean the hood using a damp cloth and a neutral liquid detergent.
- The appliance uses 4 hob elements at most.

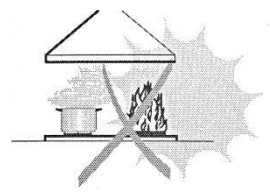

The symbol  is a packaging indication that this product may not be treated as household waste. Instead it shall be handed over to the applicable collection point for recycling of electrical and electronic equipment. By ensuring this product is disposed of correctly, you will help prevent potential negative consequences for the environment and human health, which could otherwise be caused by inappropriate waste disposing of this product. For more detailed information about recycling of this product, please contact your local city office, your household waste disposal service or the shop where you purchased your product.

COMPONENTS

Ref.	Qty.	Product Components
1	1	Hood Body, complete with Control, Light, Blower, Filter.
2.1	1	Lower Decorative Chimney
2.2	1	Upper Decorative Chimney
3	1	
4	1	Exhaust Pipe
5	2	Activated Charcoal Filter (optional)

Qty.	Documentation
1	Instruction Manual

Ref.	Qty.	Standard Installation Components
10	5	Screws 5 x 50
11	5	Wall Plug
12	4	Screws 4,2 x 9,5
13	2	Screws 5 x 12
20	1	Hood Fixing Bracket
21	1	Chimney Fixing Bracket (optional)

If choose the below installation components, see as (solution2)

Ref.	Qty.	Optional Installation Components
10	7	Screws 5 x 50
11	7	Wall Plugs
12	6	Screws 4,2 x 9,5
20	1	Hood fixing bracket
21	1	Chimney fixing bracket (optiona)

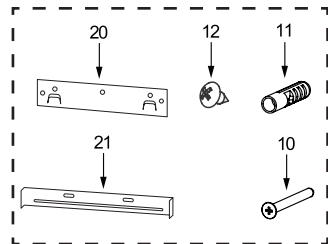
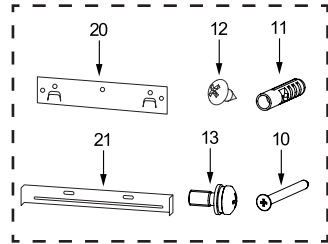
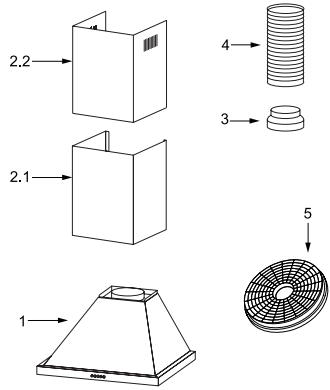

DIMENSION

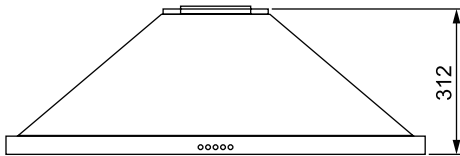
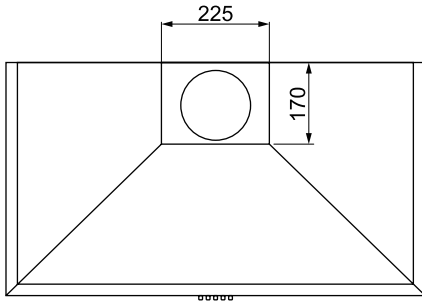

In mm

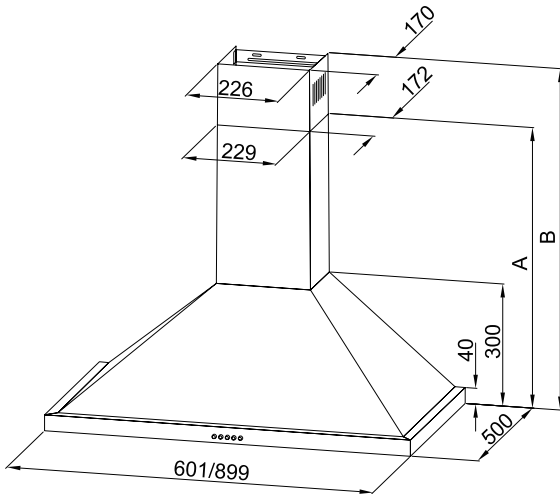
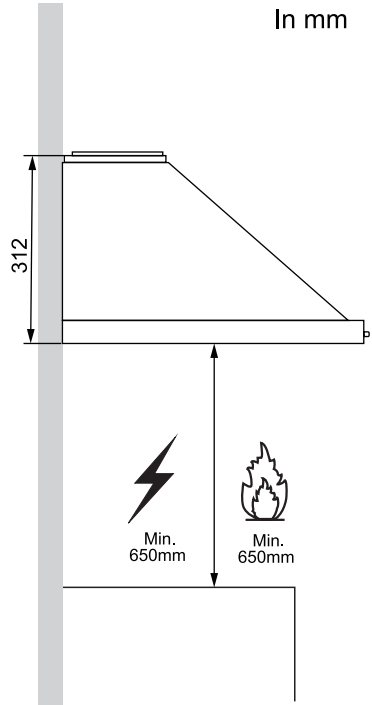

Option	Chimney	A	B
1	400+0	689	/
2	400+300	689	730-970

INSTALLATION

WALL DRILLING AND BRACKET FIXING

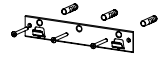
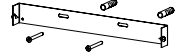
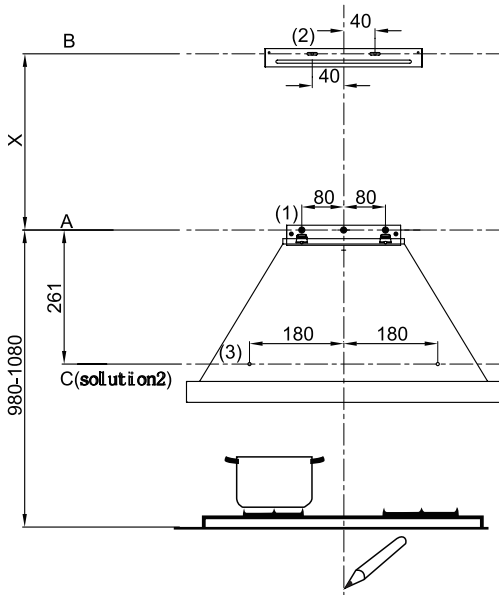

Option	Chimney	X
1	400+0	/
2	400+300	390-620

As the first step, proceed with the following drawings:

- A vertical line up to the ceiling or up to the upper limit, at the center of the area in which the hood is to be fitted.
- A horizontal line **A** at **980 – 1080** mm above the cooker top.
- A horizontal line **B** at **X** mm above the horizontal line **A**.
- A horizontal line **C** at 261 mm below the horizontal line **A** (**solution 2**).

Mark points:

- Mark a point **(1)** on the horizontal line **A**, **80** mm to the right of the vertical reference line.
- Repeat this operation on the other side and on the vertical reference line, checking that the three marks are on one horizontal line.
- Mark a point **(2)** on the horizontal line **B**, **40** mm to the right of the vertical reference line.
- Repeat this operation on the other side, checking that the two marks are on one horizontal line.
- Mark a point **(3)** on the horizontal line **C**, **180** mm to the right of the vertical reference line (**solution 2**).
- Repeat this operation on the other side, checking that the two marks are on one horizontal line.

Fix the brackets:

- Drill at the marked points **(1)**, **(2)**, **(3)** (**solution 2**), using a $\phi 10$ mm drill bit. Insert the wall plugs 11 into the holes **(1)**, **(2)**, **(3)** (**solution 2**).
- Fix the hood fixing bracket **20** with 3 screws **10** (5 x 50) at the horizontal line A. Fix the chimney fixing bracket **21** with 2 screws **10** (5 x 50) at the horizontal line B.

Hook the hood body

- Hook the hood body to the bracket **20**.
- Level the hood body itself.
- Lock screws (M5*12) into the hood fixing bracket to prevent the hood body from accidentally sliding off.
- Remove the filter from the inside of the hood body, and fix the screw **10** to wall plug **11** at the point **(3)** (optional).

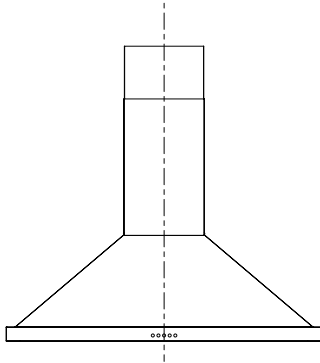

Right

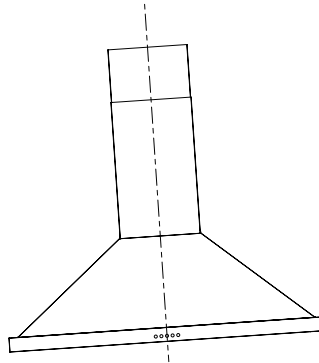

Wrong

CONNECTIONS

DUCTED VERSION AIR EXHAUST SYSTEM

When installing the ducted version, connect the hood to the chimney using either a flexible or a rigid pipe of ϕ 150 or ϕ 120 mm, the choice of which is left to the installer.

- Insert the reducer flange 3 onto the hood body outlet to install a ϕ 120 mm air exhaust connection.
- Fix the pipe 4 in place using sufficient pipe clamps (not supplied).
- Remove possible charcoal filters.

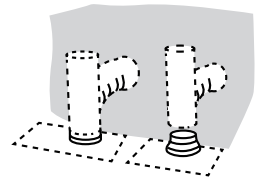

CHIMNEY ASSEMBLY

The chimney can only be installed with an exhausting hood.

Lower decorative chimney

- Fix the lower decorative chimney to the hood body with 2 screws 12 (4.2 x 9.5) supplied with the hood.

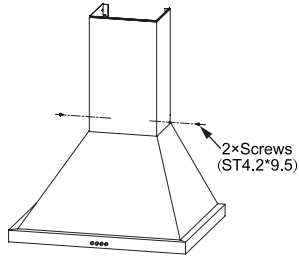

Upper Decorative Chimney



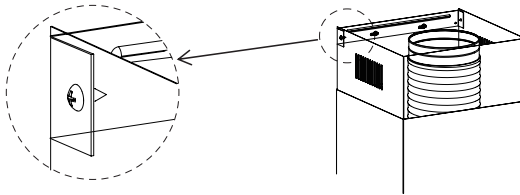

- Slightly widen the two sides of the upper chimney and hook them between the wall and the bracket **21** which is fixed on the lower decorative chimney.
- Fix the upper chimney onto the bracket **21** with 2 screws **12** (4.2 x 9.5) supplied with the hood.

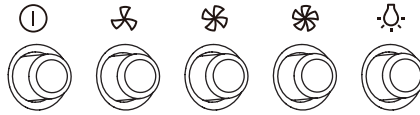

USE

Speed adjustment



	MOTOR OFF SWITCH: Press this switch to stop the motor.
	SPEED SWITCH: Press this switch, and the motor runs at LOW speed.
	SPEED SWITCH: Press this switch, and the motor runs at MEDIUM speed.
	SPEED SWITCH: Press this switch, and the motor runs at HIGH speed.
	LIGHT ON/OFF SWITCH: Press this switch to turn on the light, and press again to turn it off.

MAINTENANC

GREASE FILTER

METAL SELF-SUPPORTING GREASE FILTER CLEANING

- The filters must be cleaned every 2 months of operation or more frequently for particularly heavy usage, and can be washed in a dishwasher.
- Pull the comfort panel to open them.
- Remove the filters one by one by pushing them towards the back side of the hood unit and simultaneously pulling downwards.
- Any kind of bending of the filters has to be avoided when washing them. Before fitting them again into the hood, make sure that they are completely dry. (The color of the filter surface may change over time, but this has no influence to the filter efficiency).
- When fitting the filters into the hood, pay attention that they should be mounted in correct position with the handle facing outwards.

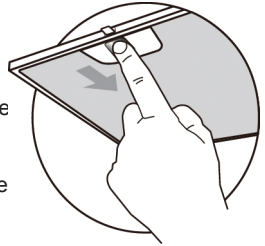

ACTIVATED CHARCOAL FILTER (RECIRCULATION VERSION)

These filters are not washable and cannot be regenerated, and must be replaced approximately every 4 months of operation or more frequently for heavy usage.

ACTIVATED CHARCOAL FILTER REPLACEMENT

- Remove the metal grease filters.
- Remove the saturated activated charcoal filter.
- Fit the new filters.
- Replace the metal grease filters.

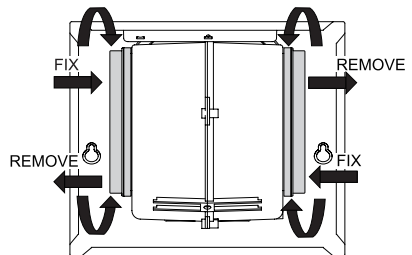

LED LIGHT REPLACEMENT

LED LIGHT MODULE DISMANTLEMENT

Replacing the light module

- You should not replace the light bulb but the entire light module.
- When changing the light module, the contacts are live.
- Before changing the light module, unplug the appliance from the mains or switch off the circuit breaker in the fuse box.

- Remove the grease filter, and carefully remove 2 screws from the front plate (a cross headed screwdriver will be needed to remove the screws).
- Disconnect the terminal of LED light.
- Press LED light at the back of the front plate, and take it out.
- Replace the light (commercially available LED light (max. 1.5 w)

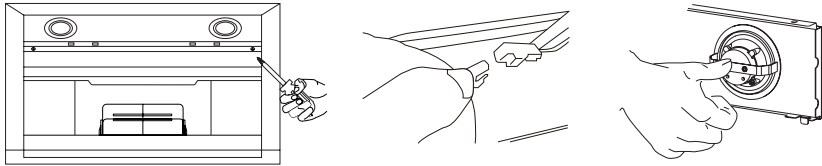

	Max Power	Voltage	Picture	Light Cap	ILCOS D Code
Round/ Diameter: 70 mm	1.5 W	DC 12 V		— —	DSR-1.5-S-70

Reinstalling LED light module

- Press LED light in the front of the front plate, and install the LED light onto the front plate.
- Connect the terminal of LED light and light leads.
- Carefully fasten 2 screws on the front plate, and reinstall the grease filter.

TROUBLE SHOOTING

Fault	Cause	Solution
Light is on, but motor does not work	The blade is blocked.	Check the blade.
	The capacitor is damaged.	Replace the capacitor.
	The motor is damaged.	Replace the motor.
	The internal wiring of motor is cut off/ disconnected. An unpleasant smell may be produced.	Replace the motor.
Both light and motor do not work	Apart from the above mentioned, check the following:	
	Light is damaged.	Replace the light.
	Power cord is loose.	Connect the cord as per the electric diagram.
Oil leakage	Outlet and the air ventilation entrance are not tightly sealed.	Take down the outlet and seal with glue.
Vibration	The blade, if damaged, can cause vibration.	Replace the blade.
	The motor is not tightly fastened.	Fasten the motor tightly.
	The cooker hood is not tightly fixed.	Fix the cooker hood tightly.
Insufficient suction	The distance between the cooker hood and the cooker top is too large.	Readjust the distance.
	Too much ventilation from open doors or windows.	Choose a new place to install the appliance or close some doors / windows.
Machine incline	The fixing screw is not tight enough.	Tighten the fixing screw and make it horizontal.
	The hanging screw is not tight enough	Tighten the hanging screw and make it horizontal.

OLD ELECTRICAL APPLIANCE DISPOSAL



The European Directive 2012/19/EU on Waste Electrical and Electronic Equipment (WEEE), requires that old household electrical appliances must not be disposed of in the normal unsorted municipal waste stream. Old appliances must be collected separately in order to optimize the recovery and recycling of the materials they contain and reduce the impact on human health and the environment.

The crossed out "Wheeled Bin" symbol on the product reminds you of your obligation, that when disposing the appliance, you need separately collect them.

Consumers should contact their local authority or retailer for information concerning the correct disposal of their old appliance.

Maintenance schedule:

To ensure the appliance continues to operate at peak performance, we recommend a routine service call every 3 years for the life of the appliance.

FOR SPARE PARTS OR TO FIND THE ADDRESS OF
YOUR NEAREST STATE SPARE PARTS CENTRE IN AUSTRALIA

MIDEA HOME APPLIANCES AUSTRALIA PTY LTD
11/75 Lorimer Street, Docklands, Melbourne, 3008
After-sales service No.: 1800 88 60 10