



Send Us a Text: 1-812-652-2525
(US and Canada Only. Carrier Fees May Apply)



Find Us Online: www.maxicosi.com
Email Us: support@djgusa.com



Give Us a Call: 1-800-544-1108
(Toll Free, US and Canada Only)

Replacement Parts List

(on select models)

- Buckle Assembly
- Chest Clip
- Seat Pad Set
- Removable Cup Holder (1)
- Removeable Snack Lid
- Removeable Snack Tray
- Lower Anchor Belt
- Locking Clip
- Instructions

For parts availability and questions,
call, text, email, or chat.

If requested color is not available,
similar color will be substituted.

Applicable tax and shipping &
handling will also be added.

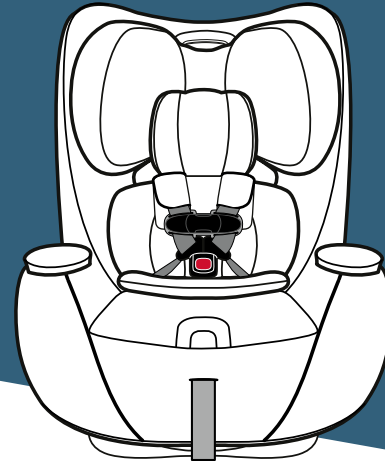

Pria™ All-in-One Pria™ Max All-in-One Pria™ Max+ All-in-One Convertible Car Seat

Your model may look different than one shown on cover.

Read all instructions BEFORE USING this car seat.
KEEP INSTRUCTIONS FOR FUTURE USE.

 **Failure to follow the warnings on the labels and in the instruction manual can result in serious injury or death to your child. Serious injury may include paralysis and/or permanent brain injury.**

4358-8674 05.06.25



Welcome to the Maxi-Cosi Family!

Thank you for choosing this car seat, also known as a child restraint!

To help you get started using your child's new car seat, here are the 4 main tasks you'll need to complete.

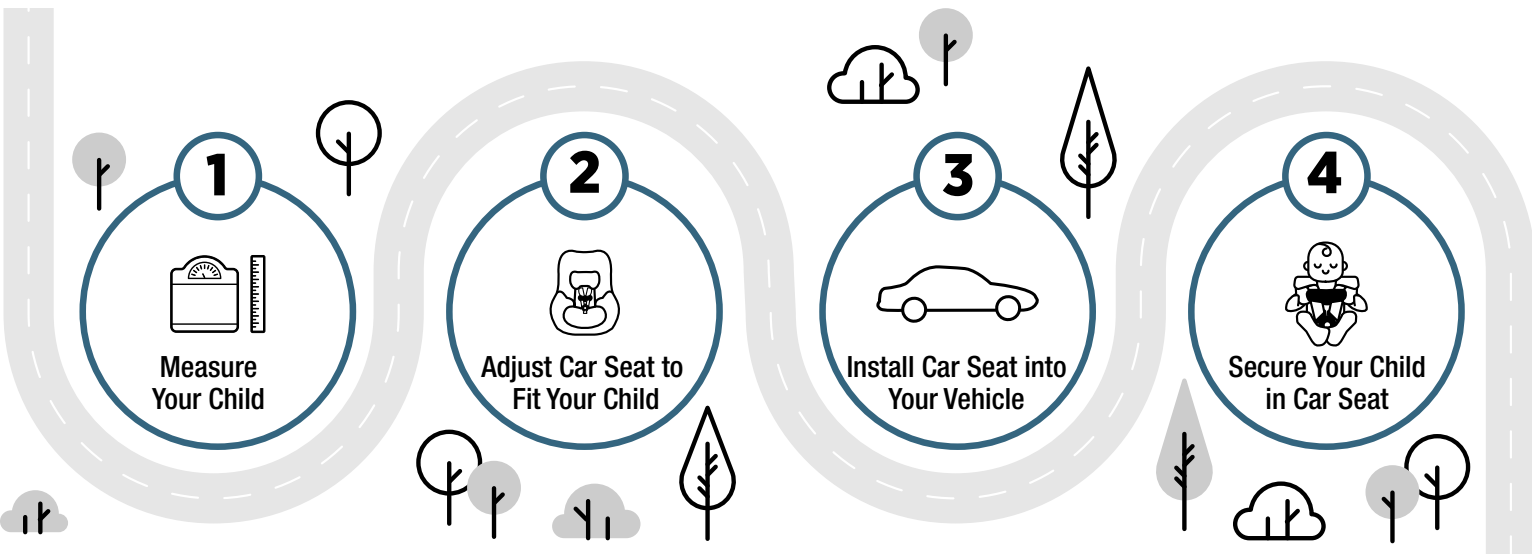

Your child's safety is worth the time it will take to read and follow these instructions.

Ready? Let's go!

Pages 1, 2, 5–7 will introduce you to the parts of the car seat.

The back cover of this manual and page 75 has our contact information.

If at any point you would like assistance, please feel free to reach out to us.

©2025 Dorel Juvenile Group, Inc. (800) 544-1108 www.maxicosi.com. Styles, colors, and labeling may vary. Les styles, les couleurs et l'étiquetage peuvent varier. Made in USA from American and imported parts (including seat pad). Fabriqué aux États-Unis à partir de pièces américaines et importées (y compris le coussin de siège). Distributed by (distribué par) Dorel Juvenile Group, Inc., 2525 State St., Columbus, IN 47201-7494. Dorel Juvenile Canada, 2233 Argentia Road, Suite 110, Mississauga, ON L5N 2X7. Representante exclusivo en Chile: DOREL JUVENILE CHILE S.A. Av. del Parque 4161, oficina 602 A, Huechuraba, Santiago, Chile - Fono: 56 2 24971500 - www.infanti.cl - www.dorel.cl. Importado y distribuido en Perú por: COMEXA COMERCIALIZADORA EXTRANJERA S.A. SUCURSAL DEL PERÚ - Los Libertadores 455, San Isidro, Lima 27, Lima, Perú RUC 20431062870 - Fono: 4413029 - www.infanti.com.pe. En Centro América, Caribe y Ecuador por: Best Brands Group S.A. - Av. Balboa, Bay Mall Plaza, Planta Baja, local 9, Panamá. - Fono: (507) 300 2884. En Colombia por: Baby Universe S.A.S. - Vía 40 No. 77-29, Barranquilla, Colombia - Fono: (575) 353 1110 Importador: DJGM, S.A. DEC.V. Gabriel Mancera No. 1041 Col. Del Valle, Benito Juárez C.P. 03100 México, Ciudad de México R.F.C. DJG140305GN9
Tel. (55) 67199202

DOREL

Contents

1 Getting Started

- 1 Parts of Car Seat
- 3 Choosing Car Seat Mode
- 5 Accessory Use

7 Making Adjustments to Car Seat

- 7 Changing Buckle Position
- 9 Harness System Adjustments for Smaller Infants
- 14 Reclining Car Seat
- 15 Changing Headrest/Harness Height

16 Rear-Facing Section

- 18 Rear-Facing Child Fit
- 21 Rear-Facing Vehicle Install

28 Forward-Facing Section

- 30 Forward-Facing Child Fit
- 33 Forward-Facing Vehicle Install

39 Securing Child in Car Seat

43 Booster Seat Section

- 45 Storing Harness System
- 50 Booster Seat Use in Vehicle
- 53 Booster Seat Child Fit

54 Wash and Care

- 54 Removing Seat Pad Set
- 59 Cleaning Parts of Car Seat and Installing Seat Pad Set

60 LATCH and Vehicle Belt Information

- 60 LATCH: Lower Anchor Belt
- 62 Vehicle Belts
- 66 Top Tether

67 Safety Information

- 67 Child Restraint Use
- 68 Vehicle Seating Position
- 69 Installation in Vehicle
- 70 Replacement and Expiration
- 71 Registration and Safety Notices
- 72 Aircraft Information

73 Warranty

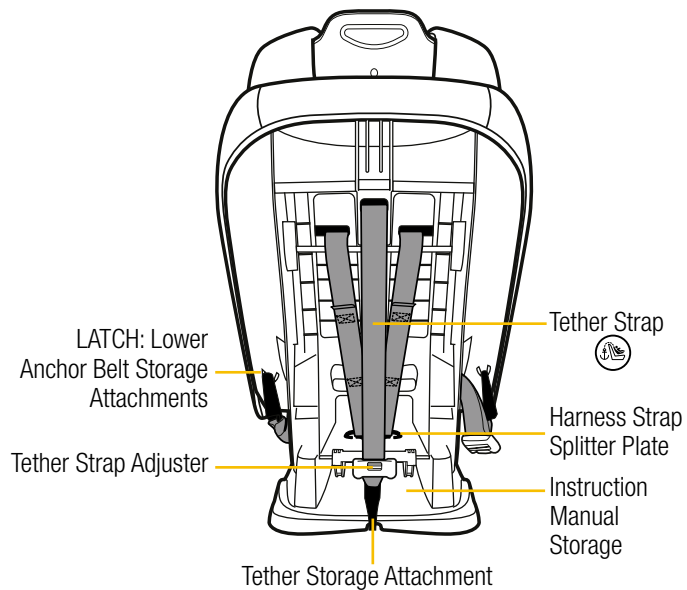
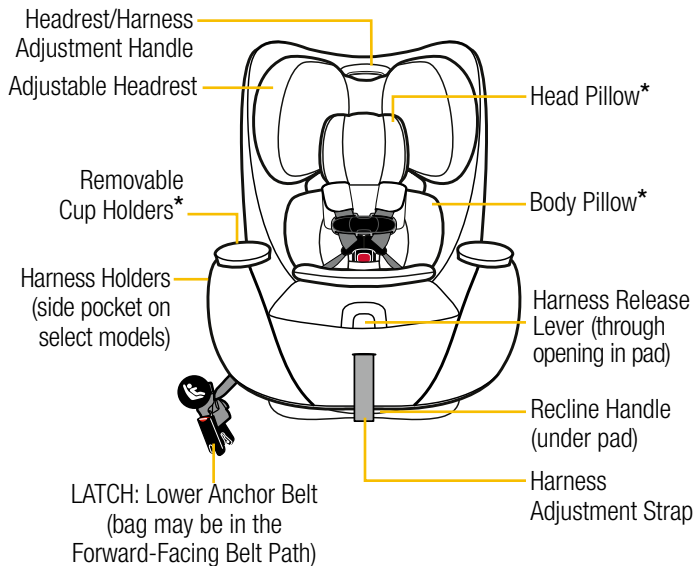

Harness System

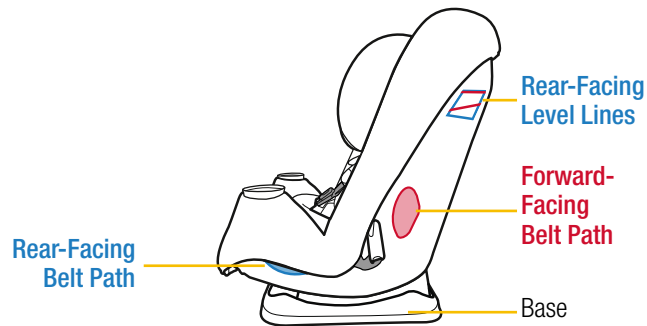
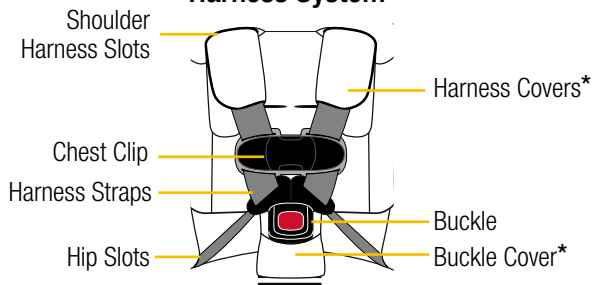

Your model may look different than one shown.

*See pages 5-7 for Accessory Use.



⚠️ WARNING

Failure to follow these instructions may result in serious injury or death to your child. Serious injury can include paralysis and/or permanent brain injury.

Be certain to measure your child's weight and height (do not guess) before choosing this car seat's mode.

Your child's height, weight, and age determine how the car seat should be placed in the vehicle.

Children vary widely in body size, shape, and temperament—**please consult your doctor before switching between any modes within the limits and fit requirements of the car seat.**

Infants and Toddlers

Children must ride rear-facing and remain rear-facing until they reach the maximum weight or height limits for rear-facing mode. Rear-facing child restraints installed behind another vehicle seat must be installed touching the back of the vehicle seat in front of it, or be as close as possible.

Toddlers and Preschoolers

Children can only use a forward-facing car seat once they outgrow rear-facing weight or height limits. Once they are forward-facing, children must use their child restraint in forward-facing mode with a harness until they reach the maximum weight or height limits for forward-facing harness mode.

School-Aged Children

Children can only use a belt-positioning booster car seat once they outgrow forward-facing harness weight or height limits. Children must use the belt-positioning booster mode until the vehicle's lap and shoulder seat belt fit them properly without the belt-positioning booster.

Rear-Facing Mode

5–40 lb (2.3–18 kg) and
19–40 in. (48–101.6 cm)



In this car seat, your child **MUST** ride **Rear-Facing** and remain in **Rear-Facing** mode until they outgrow any one of the above.

Rear-Facing Section PAGE 16

Rear-Facing Child Fit PAGE 18

Rear-Facing Vehicle Install PAGE 21

Forward-Facing Mode

30–65 lb (13.7–29.5 kg) and
34.4–49 in. (87.1–125 cm)



In this car seat, your child **MUST** remain in harnessed **Forward-Facing** mode until they outgrow any one of the above.

Forward-Facing Section PAGE 28

Forward-Facing Child Fit PAGE 30

Forward-Facing Vehicle Install PAGE 33

Booster Seat Mode

40–100 lb (18.1–45.4 kg) and
43.4–52 in. (110.1–132.1 cm)



In this car seat, your child can use the **Booster Seat** mode until they fit the vehicle's lap and shoulder seat belt properly without a **Booster Seat** **OR** outgrow any one of the above.

Booster Seat Section PAGE 43

Storing Harness System PAGE 45

Booster Seat Use in Vehicle PAGE 50

Booster Seat Child Fit PAGE 53

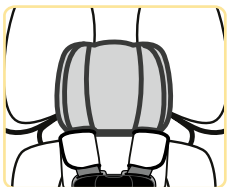

Head Pillow and Body Pillow

(on select models)

For Optional Use in Rear-Facing Mode Only

The head and body pillows **MUST** be used together.

To remove head pillow, pull it out from behind the body pillow.

To remove body pillow, undo the buckle and pull it through the slot in the pillow. Slide the pillow out from behind the harness straps.

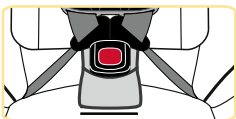
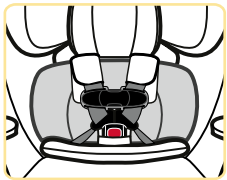

Buckle Cover

(on select models)

For Optional Use in Rear-Facing Mode or Forward-Facing Mode

To remove, undo the buckle and pull the buckle cover off the buckle.

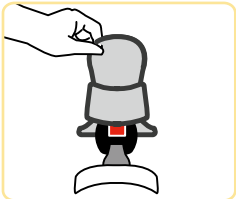

EZ Out Buckle Cover

(on select models)

For Optional Use in Rear-Facing Mode or Forward-Facing Mode

To install, slide buckle into opening in front of buckle cover.

NOTE: Slide buckle cover only through slot in pad and **not** through buckle slot in shell. It lays flat underneath the pad as shown.

To remove, pull up on buckle cover and slide it off of the buckle and pull it out of the buckle slot in the seat pad.

Harness Covers (on select models)

For Optional Use in Rear-Facing Mode or Forward-Facing Mode

To remove, pull the fastening strips apart and pull the harness covers off of the harness straps.

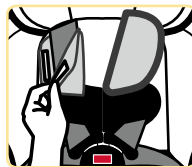
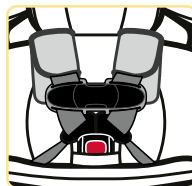

i

The harness covers help provide comfort to your child's neck.

If the harness covers will not allow proper positioning of the chest clip or interfere with getting a tight enough harness fit for a smaller infant, remove and do not use.

Store until your child is large enough to use the harness covers while maintaining a properly fitting harness.



Back View



Front View

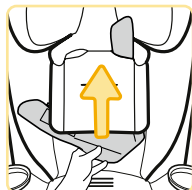

EZ Out Harness Covers

(on select models)

For Optional Use in Rear-Facing Mode or Forward-Facing Mode

To remove, undo fasteners on headrest pad. Pull the fastening strips on covers apart. Pull harness straps out of covers. Slide covers out from behind headrest pad.

To install, undo fasteners on headrest. With the back of the harness covers facing you slide covers behind headrest pad. Place harness straps into covers. Fasten headrest fasteners and harness covers.

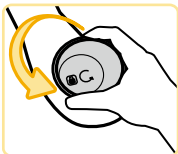

Removable Cup Holder(s) (on select models)

For Use in All Modes

The cup holder is top-rack dishwasher safe.



To remove cup holder, twist the cup holder counterclockwise. Pull it out of the slot in the car seat.

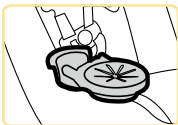

Removable Snack Lid and Tray (on select models)

The snack lid and tray are top-rack dishwasher safe.

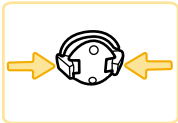

To remove snack lid, pull it off the top of the cup holder.

To remove snack tray, locate the two tabs underneath the snack tray. Squeeze them together and lift the snack tray out of the slot in the car seat.

Changing Buckle Position

⚠ WARNING

Failure to place buckle's metal retainer completely through pad and child restraint can result in serious injury or death. Serious injury can include paralysis and/or permanent brain injury.

1

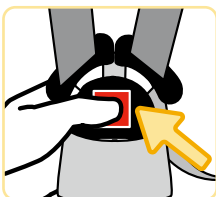

Undo Buckle

It may be easier to undo the buckle by pressing in towards the top of the button.

2

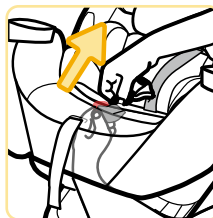

3

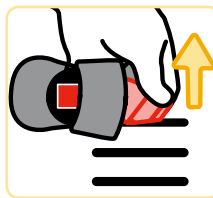

4

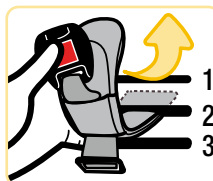
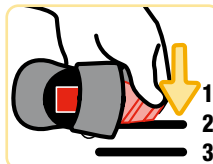

5

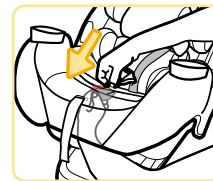

Recline Car Seat to Push Up Metal Retainer

Reach under between the base and the car seat. Rotate the buckle's metal retainer and push it up through the car seat.

To recline seat, see page 14.

From Top of Car Seat, Pull Buckle and Buckle Cover Out of Car Seat and Pad

Insert Buckle's Metal Retainer into Buckle Slot Closest to Child

Tuck the ends of the buckle cover into the same pad slot as the buckle.

For EZ Out Style: Slide the buckle cover into the seat pad slot closest to the child and then complete the rest of step 4 above.

Reach Under Car Seat Between Base and Car Seat

Pull the buckle's metal retainer completely through the seat pad and car seat.

continued on next page

6



Check Buckle

Pull the buckle up to make sure it is secured.

The buckle **MUST NOT** pull out.

i

For **Rear-Facing Child Fit**, see page 18.

For **Forward-Facing Child Fit**, see page 30.

To learn how to check harness tightness, see pages 39–42.

If you cannot achieve a snug harness fit for your child, see page 9.

Harness System Adjustments for Smaller Infants

i

When using the lower shoulder harness slots for smaller children, you **MUST** use the head and body pillow and the headrest **MUST** be in the lowest position.

Adjusting the Buckle Strap for Smaller Infants

⚠ WARNING

The harness system **MUST** be installed correctly.

DO NOT use a child restraint with damaged harness straps.

1

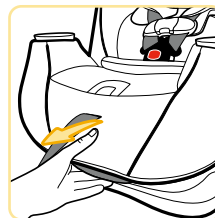

2

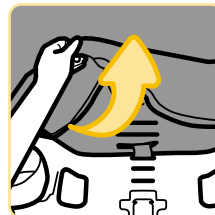

3

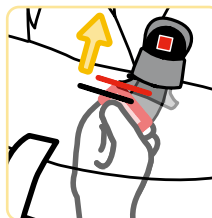

4

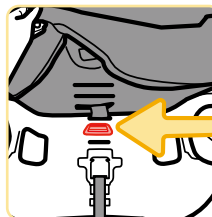

5

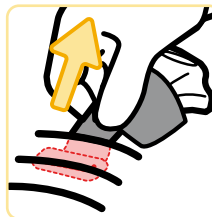

With Buckle in 1st Slot, Fully Recline Car Seat

If you need to move the buckle to the 1st slot, see pages 7–9.

Pull Front of Car Seat Pad Up

Reach Under Car Seat

Pull the buckle's metal retainer down and then push it up into the middle slot as shown.

From Top of Car Seat, Lay Metal Retainer Flat Against Car Seat

Tuck Car Seat Pad Around Front of Car Seat and Check Buckle

Pull the buckle up to make sure it is secured.

The buckle **MUST NOT** pull out.

Adjusting the Harness Straps for Smaller Infants

1

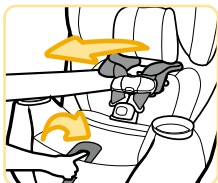

Fully Loosen
Harness Straps and
Adjust Headrest to
Lowest Position

See page 15.

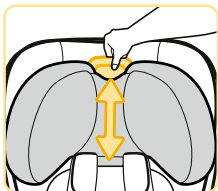

2

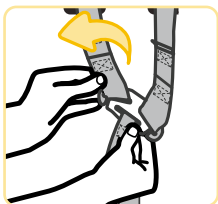

From Back of Car Set,
Remove Harness Strap
Loops from Splitter Plate

3



Pull Harness Straps
Out of Upper Shoulder
Harness Slots

4

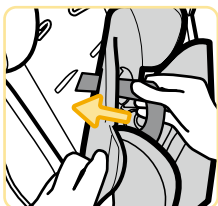

Thread Harness Straps
through Lower Shoulder
Harness Slots

Pull the body pillow slightly away from the backrest. Insert the harness straps through the slots in the body pillow and then through the lower shoulder harness slots in the seat pad and the car seat.

5

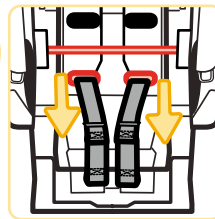

From Back of Car Seat,
Pull Harness Straps
through Car Seat

The harness straps **MUST** be in the shoulder harness slots **below** the metal bar.

6

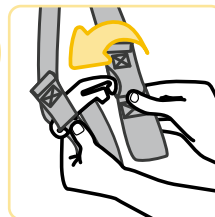

Attach Second Harness
Strap Loops to
Splitter Plate

i

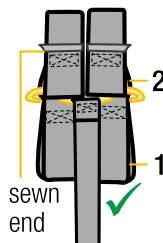

The sewn ends of the harness strap loops **MUST** face towards you.

DO NOT twist the harness strap or the harness adjustment strap.

Make sure the upper harness strap loops (labeled "2") are fitted completely on both sides of the splitter plate. **DO NOT** use the lower loops (labeled "1" above) for smaller infants.

continued on next page



To return the harness straps to upper shoulder harness slots, follow the steps below to rethread them.

1. Remove the harness strap loops from the splitter plate and pull the harness straps out of the lower shoulder slots in the body pillow and car seat.

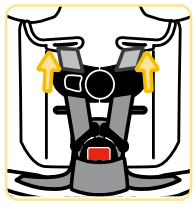

2. Thread the harness straps into the upper shoulder slots in the seat pad and car seat.

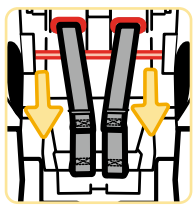

3. From the back of the car seat, thread the harness straps **OVER** the metal bar.

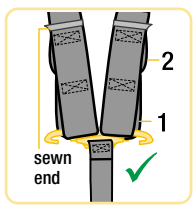

4. Attach the first harness strap loops to the splitter plate.

The sewn ends of the harness strap loops **MUST** face towards you.

DO NOT twist the harness strap or the harness adjustment strap.

Make sure the lower harness strap loops (labeled "1") are fitted completely on both sides of the splitter plate.

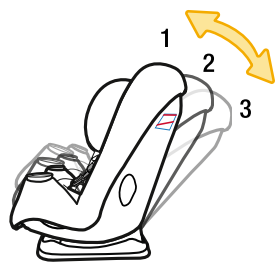

This car seat has 3 positions.

Rear-Facing Mode - 3 Reclined or 2 Semi-reclined

Use Position 3 or 2 to make sure the appropriate **Rear-Facing Level Line** is parallel with the ground. To determine which level line to use for your child's weight and height, see step 2 on page 22.

Forward-Facing Mode - **Position 1** Fully upright

Booster Seat Mode - **Position 1** Fully upright

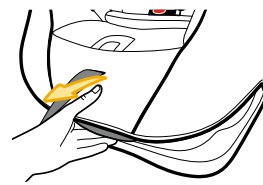

To Recline: Pull the recline handle out and push the top of the car seat back.

To Change to a More Upright Position: Pull the recline handle out and pull the top of the car seat forward.



In **Forward-Facing Mode** or **Booster Seat Mode**, the vehicle seat back **MUST** be in the upright position, but you can adjust the angle slightly to better match the angle of the car seat. Refer to the vehicle owner's manual for how to adjust the vehicle seat back.

1

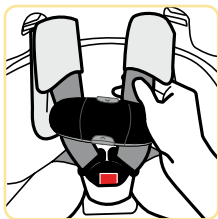

Fully Loosen Harness Straps

Place your hand between the harness cover and harness strap.

You may need to undo the harness cover or move the chest clip down.

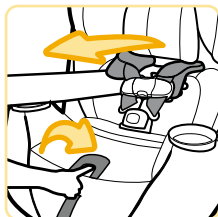

Push down on the harness release lever (through the opening in the pad) while pulling out on the harness straps as shown.

2

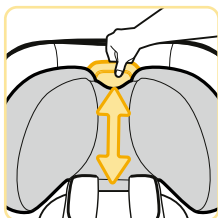

Adjust Headrest/ Harness Height

1. Squeeze the adjustment handle lever up.
2. Move the headrest up or down to the proper height for your child.

3. Release the handle to lock in place.

4. Make sure it is locked securely.

i

For Rear-Facing Child Fit, see page 18.

For Forward-Facing Child Fit, see page 30.

To learn how to check harness tightness, see pages 39–42.

If you cannot achieve a snug harness fit for your child, see page 9.

Check the harness straps often for any wear or damage.

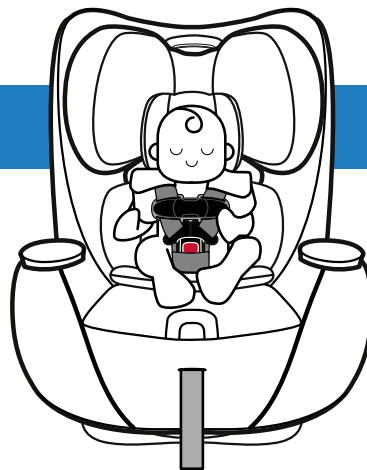

**5–40 lb (2.3–18 kg) and
19–40 in. (48–101.6 cm)**

In this car seat, your child MUST ride **Rear-Facing and remain in **Rear-Facing** mode until they outgrow any one of the following:**

- **Weight Limit:** 40 lb (18 kg); **OR**
- **Height Limit:** 40 in. (101.6 cm); **OR**
- **Rear-Facing Child Fit** requirements, see page 18.

Before installing the car seat in your vehicle, check your child's fit in the car seat.

This way you won't have to redo the vehicle installation to make adjustments to the car seat.

Rear-Facing Child Fit: Page 18

Rear-Facing Vehicle Install: Page 21

⚠️ WARNING



NEVER install a rear-facing child restraint in the front seat of a vehicle equipped with an active frontal airbag.

DO NOT use the tether for rear-facing mode. Secure the tether strap hook to its storage attachment.

DO NOT use the lower anchor belt along with the vehicle lap or lap/shoulder belt.

DO NOT fasten multiple lower anchor hooks on the same lower anchor bar in the vehicle.

Check the vehicle belt or the lower anchor belt before each use.

Use **ONLY** if the belt can be tightened properly and locked securely in place.

Even when unoccupied, this child restraint **MUST** be firmly secured to the vehicle with the lower anchor belt or with the vehicle seat belt.

This child restraint **MUST ALWAYS** face the rear of the vehicle until the child has reached the maximum weight or height limit for the rear-facing mode.

1

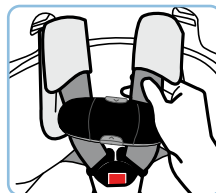

Fully Loosen Harness Straps

Place your hand between the harness cover and harness strap.

You may need to undo the harness cover or move the chest clip down.

Push down on the harness release lever (through the opening in the pad) while pulling out on the harness straps as shown.

2

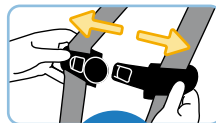

OR

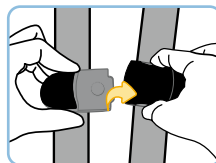
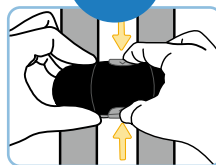

Undo Chest Clip

While holding both sides of the chest clip, press the release button with your thumb and pull the chest clip apart.

For magnetic chest clip: Hold the chest clip with both hands and press in on the top and bottom buttons with your index finger and thumb as shown.

While pressing both buttons, pull the right (top) half of the clip apart from the left (bottom) half to release the magnet and separate the chest clip.

3



Undo Buckle

Press the red button to release the buckle tongues.

4

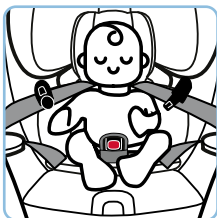

Place Child in Car Seat

Your child's bottom and back should be flat against the car seat.

On select models: You may use the side pocket harness holders to put the harness straps out of the way while placing your child in the seat.

5

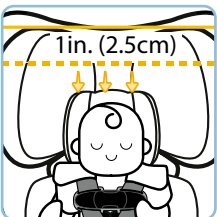

Check Head Position

The top of your child's head **MUST** be at least 1 in. (2.5 cm) **below** the top of the car seat's headrest.

6

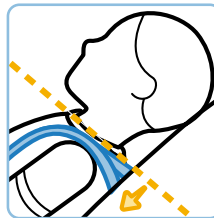

Check Harness Strap Position

The harness strap **MUST** be placed **at the shoulder** when possible, or slightly below; never above.

7

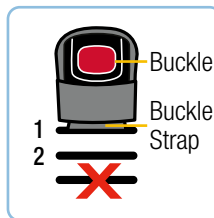

Check Buckle Position

- Use the slot closest to your child.
- The buckle strap **should not be underneath or behind** your child.

DO NOT use the 3rd buckle slot in **Rear-Facing Mode**.

i

To change the harness strap height, see page 15.

To change the buckle position, see page 7.

To learn how to check harness tightness, see pages 39–42.

If you cannot achieve a snug harness fit for your child, see page 9.



- Before installing the car seat in your vehicle, check to see if you need to adjust the buckle position for your child. **See step 7 on page 20 for child fit.** Once the car seat is installed, you will not be able to adjust the buckle position.
- **Review vehicle owner's manual.** Determine the type of vehicle belts in your car and how to use them to lock a car seat in place **OR** where LATCH: lower anchor seating positions are located in your vehicle.
- If you are using a vehicle belt to install the seat, make sure the lower anchor belt is stored away (see page 61).
- Make sure the tether strap is properly stored away (see page 66).

There are 2 different methods for install.

Use only one:



Vehicle Belt

OR



LATCH: Lower
Anchor Belt

⚠ WARNING

DO NOT use both the LATCH: lower anchor belt and vehicle belt at the same time to install the car seat.

1



Place Car Seat Rear-Facing in Back Seat

The car seat base **MUST** be flat on the vehicle seat.

When using the passenger and driver side locations, the car seat **MUST** be touching the back of the vehicle seat in front of it, or be as close as possible.

2



Recline handle is at front of car seat.

Recline Car Seat and Check Rear-Facing Level Lines

For children 5–30 lb (2.3–13.6 kg) and 19–34.3 in. (48–87 cm), the bottom level line on the car seat **MUST** be parallel with the ground.

For children 30–40 lb (13.7–18 kg) and 34.4–40 in. (87.1–101.6 cm)

AND can sit up unassisted, the top level line on the car seat **MUST** be parallel with the ground.

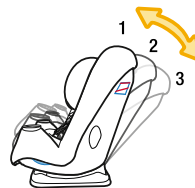

Use **Position 2** or **3** to make sure the appropriate level line for your child's weight and height is parallel with the ground.

DO NOT use **Position 1** for **Rear-Facing Mode**. See Reclining Car Seat on page 14.

3



OR



Locate **Rear-Facing Belt Path** and Route Vehicle Belt or Lower Anchor Belt through It

For the Lower Anchor Belt: You may need to fully lengthen the belt before routing it into the belt path. Squeeze the adjuster button and pull the belt out as shown.

Thread the connector without the adjuster closest to it through the **Rear-Facing Belt Path** opening as shown.



4

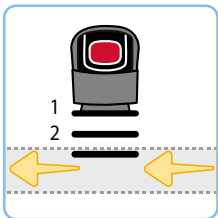

Vehicle Belt or Lower Anchor Belt Goes:

- Under the car seat pad; **AND**
- Across the car seat; **AND**
- In front of the buckle; **AND**
- Out the other **Rear-Facing Belt Path** opening.

DO NOT twist the belt.

i

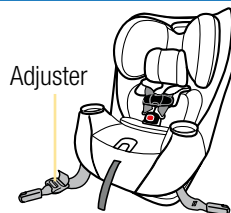

Finished Lower Anchor Belt Routing

The lower anchor belt adjuster **MUST** be on the child's right.

5

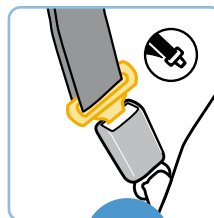

OR

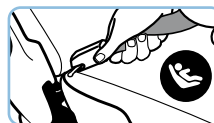
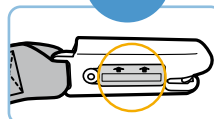

Buckle Vehicle Belt

If your car has a **switchable retractor**, use it to lock the vehicle belt. Review page 66 of this manual or your vehicle owner's manual.

Attach Lower Anchor Belt Connectors to Vehicle's Lower Anchors

On select models: Make sure the arrows on the connectors are facing up.

Fasten one lower anchor belt connector to the anchor located in the vehicle seat.

Repeat for other side of car seat.

6

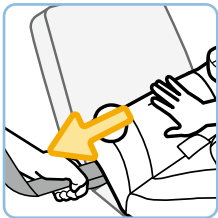

Tighten Belt

Place your hand in the car seat and firmly push the car seat down and back towards the vehicle seat. Pull the belt towards you and parallel (in line) with the belt path as shown.

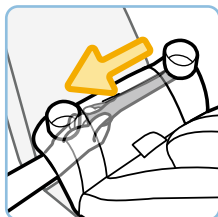

For the Lower Anchor Belt or Lap Only Vehicle Belt: it may be easier to tighten if you route the free end of the belt back into the **Rear-Facing Belt Path**, reach into the **Rear-Facing Belt Path**, and pull the free end of the belt towards you.

7

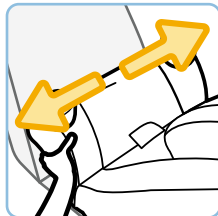

Check Belt Tightness

Hold the **Rear-Facing Belt Path** with your non-dominant hand. Push and pull the car seat from side to side.

The car seat should not move more than **1 in.** (2.5 cm) at the belt path.

i

If the car seat moves more than 1 in. (2.5 cm), you can try:

- Pulling the belt tighter; **OR**
- Reinstalling the car seat; **OR**
- Changing to a different seating location; **OR**
- Switching to a different install method (LATCH or vehicle belt).

8

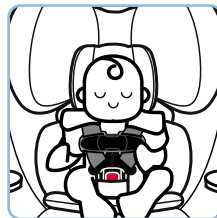

Secure Child in Car Seat

See pages 39–42.

9

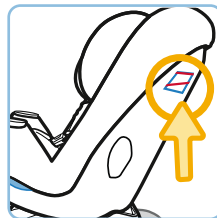

Recheck Rear-Facing Level Lines

Redo the installation if the car seat is not reclined correctly for your child. See step 2 and the info box on page 22.

i



Only if necessary, you may place a tightly rolled towel(s) or foam pool noodle(s) under the front of the car seat base to help make the appropriate **Rear-Facing Level Line** for your child's weight and height parallel with the ground.

Check often to make sure padding is still in place and the belt is tight.

FINISHED!

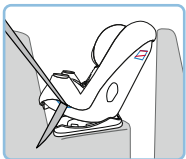

Lap/Shoulder Belt

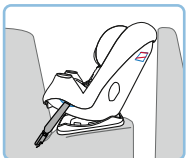

Lap Belt

LATCH: Lower
Anchor Belt

- Vehicle Belt Install:** Is the vehicle belt locked?
See step 5.
- LATCH: Lower Anchor Belt Install:** Are the connectors
securely attached to the vehicle's lower anchors?
See step 5.
- Is the belt tightened enough so that the car seat does not
move more than 1 in. (2.5 cm) from side to side at the
belt path? Check the tightness of the install often to make
sure it has not loosened. See steps 6 and 7.
- Is the appropriate level line for your child parallel with the
ground? See step 2 and the info box on page 22 and
step 9 and the info box on page 26.

When using the passenger and driver side locations, the car seat **MUST** be touching the back of the vehicle seat in front of it, or be as close as possible.



30–65 lb (13.7–29.5 kg) and
34.4–49 in. (87.1–125 cm)

In this car seat, your child **MUST** remain in harnessed **Forward-Facing** mode until they outgrow any one of the following:

- **Weight Limit:** 65 lb (29.5 kg); **OR**
- **Height Limit:** 49 in. (125 cm); **OR**
- **Forward-Facing Child Fit** requirements, see page 30.

Before installing the car seat in your vehicle, check your child's fit in the car seat.

This way you won't have to redo the vehicle installation to make adjustments to the car seat.

Forward-Facing Child Fit: Page 30

Forward-Facing Vehicle Install: Page 33

⚠ WARNING

DO NOT use the lower anchors of the child restraint anchorage system (LATCH system) to attach this child restraint when restraining a child weighing more than 50 lb (22.7 kg).

The vehicle belt **MUST** be used for installation if your child weighs more than 50 lb (22.7 kg).

When anchors are available, you **MUST ALWAYS** attach, adjust, and secure the tether (top anchorage) strap when installing the car seat in the Forward-Facing mode with internal harness.

DO NOT use the lower anchor belt along with the vehicle lap or lap/shoulder belt.

Check the vehicle belt or the lower anchor belt before each use.

Use **ONLY** if the belt can be tightened properly and locked securely in place.

DO NOT fasten multiple lower anchor hooks on the same lower anchor bar in the vehicle.

Even when unoccupied, this child restraint **MUST** be firmly secured to the vehicle with the lower anchor belt or with the vehicle seat belt.

Before using this seat in Forward-Facing mode, your child must have outgrown the seat in Rear-Facing mode.

1

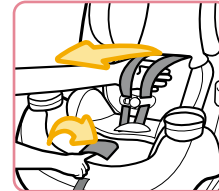
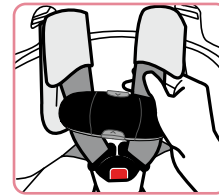
**Fully Loosen
Harness Straps**

Place your hand between the harness cover and harness strap.

You may need to undo the harness cover or move the chest clip down.

Push down on the harness release lever (through the opening in the pad) while pulling out on the harness straps as shown.

2

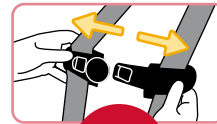

OR

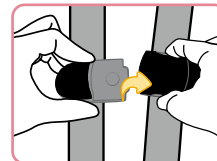
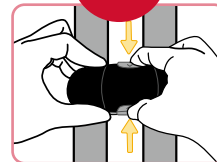
**Undo Chest Clip**

While holding both sides of the chest clip, press the release button with your thumb and pull the chest clip apart.

For magnetic chest clip: Hold the chest clip with both hands and press in on the top and bottom buttons with your index finger and thumb as shown.

While pressing both buttons, pull the right (top) half of the clip apart from the left (bottom) half to release the magnet and separate the chest clip.

3

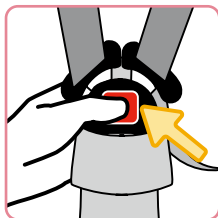

Undo Buckle

It may be easier to undo the buckle by pressing in towards the top of the button.

4



Place Child in Car Seat

Your child's bottom and back should be flat against the car seat.

On select models: You may use the side pocket harness holders to put the harness straps out of the way while placing your child in the seat.

5

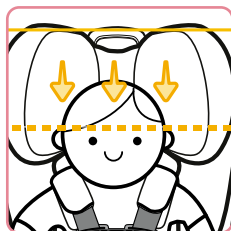

Check Head Position

The top of your child's ears **MUST be below** the top of the car seat's headrest.

6

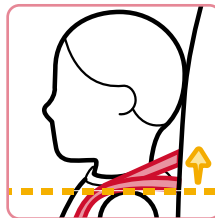

Check Harness Strap Position

The harness strap **MUST** be placed **at the shoulder** when possible, or slightly above; never below.

7

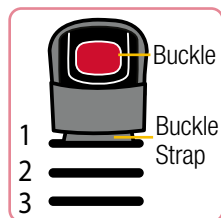

Check Buckle Position

- Use the slot closest to your child.
- The buckle strap **should not be underneath or behind** your child.

The buckle can be used in **any** buckle slot.

i

To change the harness strap height, see page 15.

To change the buckle position, see page 7.

To learn how to check harness tightness, see pages 39–42.

i

- Before installing the car seat in your vehicle, check to see if you need to adjust the buckle position for your child. **See step 7 on page 32 for child fit.** Once the car seat is installed, you will not be able to adjust the buckle position.
- **Review vehicle owner's manual.** Determine what kind of vehicle belts your car has and how to use them to lock a car seat in place **OR** where LATCH: lower anchor seating positions are located in your vehicle.
- If you are using a vehicle belt to install the seat, make sure the lower anchor belt is stored away (see page 61).

There are 2 different methods for install.

Use only one:



Vehicle Belt + Tether

for a child up to 65 lb (29.5 kg)

OR



LATCH: Lower Anchor Belt + Tether

Do not install by this method for a child weighing more than 50 lb (22.7 kg).

WARNING

DO NOT use both the LATCH: lower anchor belt and vehicle belt at the same time to install the car seat.

When anchors are available, you **MUST ALWAYS** attach, adjust, and secure the tether (top anchorage) strap when installing the car seat in the Forward-Facing Mode with internal harness.

1



Recline handle is at front of car seat.

Put Car Seat Upright into Position 1 and Place Car Seat **Forward-Facing** in Back Seat

The base of the car seat should be flat against the vehicle seat bottom. The vehicle seat back **MUST** be in the upright position, but you can adjust the angle slightly to better match the angle of the car seat. Refer to the vehicle owner's manual for how to adjust the vehicle seat back.

i

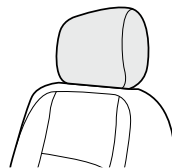

If your vehicle has a headrest that interferes with a flush car seat fit, check your vehicle owner's manual to see if it can be removed, adjusted, or if there are other possible seating locations for you to install.

2



Locate Vehicle Top Tether Anchors

Review your vehicle owner's manual for top tether anchor locations and how to route the tether strap when there are vehicle headrests.

3

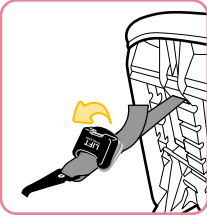

Loosen Tether Strap

Lift the tether adjuster to loosen the strap. Or, if your car seat has an adjuster with a button, then squeeze the adjuster button and pull the strap to loosen as shown.



4

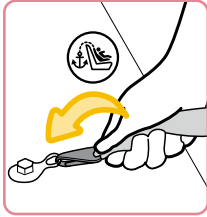

Attach Tether Hook to Vehicle's Top Tether Anchor

5

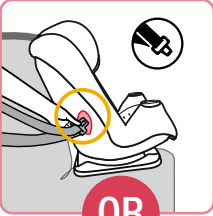

Locate **Forward-Facing Belt Path** and Route Vehicle Belt or Lower Anchor Belt through It

For the Lower Anchor Belt: You may need to fully lengthen the belt before routing it into the belt path. Squeeze the adjuster button and pull the belt out as shown.



Thread the connector with the adjuster closest to it through the **Forward-Facing Belt Path** opening as shown.



6

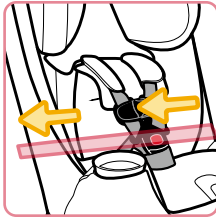

Vehicle Belt or Lower Anchor Belt Goes:

- Under the car seat pad; **AND**
- Across the car seat; **AND**
- Out the other **Forward-Facing Belt Path** opening. **DO NOT twist the belt.**

i

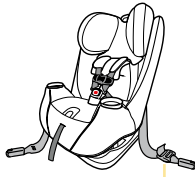

Finished Lower Anchor Belt Routing

The lower anchor belt adjuster **MUST** be on the child's left.

Adjuster

7

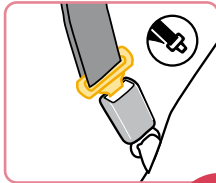

Buckle Vehicle Belt

If your car has a **switchable retractor**, use it to lock the vehicle belt. Review page 68 of this manual or your vehicle owner's manual.

OR

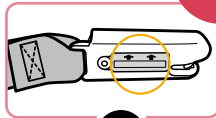

Attach Lower Anchor Belt Connectors to Vehicle's Lower Anchors

On select models: Make sure the arrows on the connectors are facing up.



Fasten one lower anchor belt connector to the anchor located in the vehicle seat bight. Repeat for other side of car seat.

8

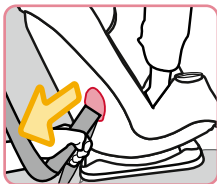

Tighten Belt

Place your hand in the car seat and firmly push the car seat down and back towards the vehicle seat. Pull the belt towards you and parallel (in line) with the belt path as shown.

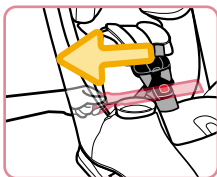

For the Lower Anchor Belt or Lap Only Vehicle Belt: it may be easier to tighten if you route the free end of the belt back into the **Forward-Facing Belt Path**, reach into the **Forward-Facing Belt Path**, and pull the free end of the belt towards you.

9

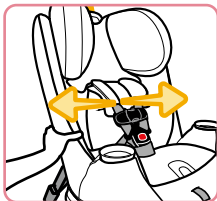

Check Belt Tightness

Hold the **Forward-Facing Belt Path** with your non-dominant hand. Push and pull from side to side.

The car seat should not move more than **1 in.** (2.5 cm) at the belt path.

i

If the car seat moves more than 1 in. (2.5 cm), you can try:

- Pulling the belt tighter; **OR**
- Reinstalling the car seat; **OR**
- Changing to a different seating location; **OR**
- Switching to a different install method (LATCH or vehicle belt).

10

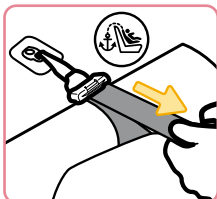

Tighten Tether

Push firmly on the back of the car seat and pull the free end of the tether strap to remove all of the slack.

FINISHED!



Lap/Shoulder Belt + Tether
for a child up to 65 lb (29.5 kg)



Lap Belt + Tether
for a child up to 65 lb (29.5 kg)



LATCH: Lower Anchor Belt + Tether
Do not install by this method for a child weighing more than 50 lb (22.7 kg).

- Vehicle Belt Install:** Is the vehicle belt locked?
See step 7.
- LATCH: Lower Anchor Belt Install:** Are the connectors securely attached to the vehicle's lower anchors? See step 7.
- Is the belt tightened enough so the car seat does not move more than 1 in. (2.5 cm) from side to side at the belt path? Check the tightness of the install often to make sure it has not loosened. See steps 8 and 9.
- Has the tether been installed and tightened? See steps 4 and 10.

⚠️ WARNING

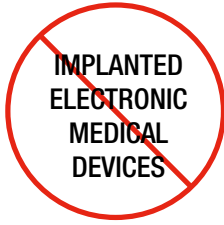

DO NOT use the magnetic chest clip with children who have an implanted electronic medical device.

A magnet is used to help secure the chest clip locking mechanism together which may interfere with the proper function of an implanted

electronic medical device.

Parents or caregivers who have an implanted electronic device should keep their device away from the chest clip and consult their doctor and medical device manufacturer for specific information before using this chest clip.

If a parent/caregiver or child has an implanted electronic medical device, please contact Dorel (see back cover) for a replacement (non-magnetic) chest clip free of charge.

1

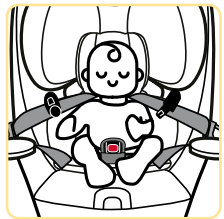

Place Child in Car Seat

Your child's bottom and back should be flat against the car seat.

2

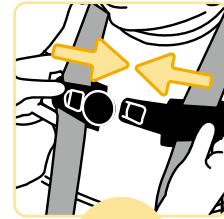

OR

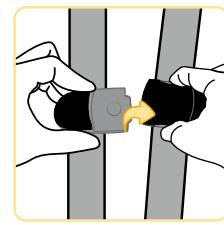
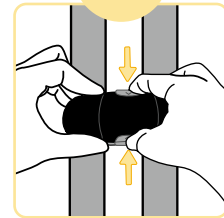

Fasten Chest Clip

Insert right half of the chest clip into the left half and snap together.

For Magnetic Chest Clip: Lay the right (top) half of the chest clip over the left (bottom) half and it will automatically snap together and lock.

Pull gently on each half of the chest clip together to make sure it is locked.

3

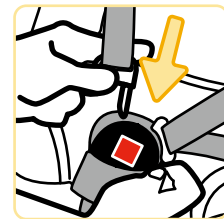

Buckle Harness

Pull the harness straps up to make sure the buckle is locked.

4

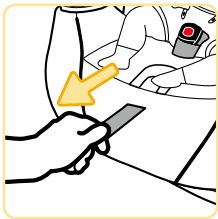

Tighten Harness

Pull the harness adjustment strap straight out to snugly tighten the harness.

5

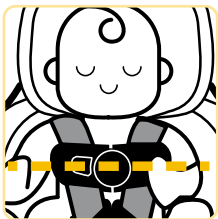

Position Chest Clip

Slide the chest clip up the harness straps and position it at mid-chest (even with armpits) and away from your child's neck.

6

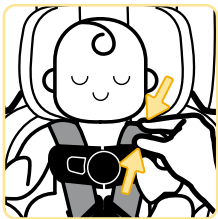

Check Harness Tightness

Unfasten the harness covers.

Try to pinch the harness at the shoulders vertically between index finger and thumb as shown.

If your fingers slip off, the harness is tight enough.

If you can pinch the harness strap, tighten more.

Fasten the harness covers.

i

A snug strap should not allow any slack. It lies in a relatively straight line without sagging. It does not press on the child's flesh or push the child's body into an unnatural position.

If one side of the harness is tighter than the other, lengthen the tighter side by pulling up the harness near the hip slot.

FINISHED!



Your child is now secured in the car seat.

Check your child's fit often and make any needed adjustments to the car seat as they grow.

To Remove Child from Car Seat:

1. Loosen harness strap.
2. Unbuckle harness.
3. Release chest clip.
4. Remove child.

Troubleshooting

1. **If the buckle or harness release lever sticks: DO NOT lubricate.** Check for dropped food, sticky spilled drinks, dirt, leaves, etc. Clean with warm water and/or remove the object with tweezers. If you cannot get the harness to adjust and remain tight with the buckle securely locked, **DO NOT** use this car seat.
2. **If your harness twists:** Straighten the harness each time you put your child in the car seat. Lock the buckle and tighten the harness so it will be ready for next use.

⚠️ WARNING

Failure to fasten and tighten the harness system correctly may allow the child to be ejected from the child restraint in a crash or sudden stop causing serious injury or death. Serious injury can include paralysis and/or permanent brain injury.



DO NOT mistake comfort for safety. The harness system **MUST** be snugly adjusted.

DO NOT put snowsuits or bulky garments on your child when placing them in the child restraint.

Bulky clothing can prevent the harness straps from being tightened properly.



40–100 lb (18.1–45.4 kg) **and**
43.4–52 in. (110.1–132.1 cm)

In this car seat, your child can use the **Booster Seat** mode until they fit the vehicle's lap and shoulder seat belt properly without a **Booster Seat** OR outgrow any one of the following:

- **Weight Limit:** 100 lb (45.4 kg); **OR**
- **Height Limit:** 52 in. (132.1 cm); **OR**
- **Booster Seat Child Fit** requirements, see page 53.

You **MUST** store the harness system and remove the accessories, except the cup holders and/or snack tray, when using the **Booster Seat Mode**.

To remove accessories, see pages 5–7.

Storing Harness System: Page 45

Booster Seat Use in Vehicle: Page 50

Booster Seat Child Fit: Page 53

⚠ WARNING

DO NOT use the harness system when using as a booster seat.

DO NOT use LATCH when using as a booster seat. Secure the lower anchor belt and the tether strap to their storage attachments.

Warning! Use only the vehicle's lap and shoulder belt system when restraining the child in this booster seat.

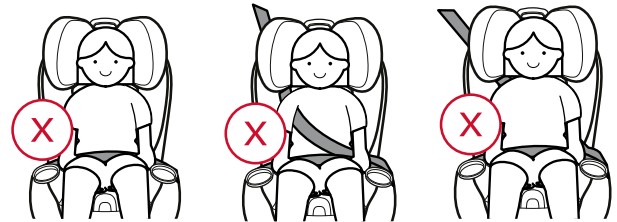

DO NOT use only the lap belt when using this seat as a booster seat. The shoulder belt **MUST** always be adjusted snugly across the child's chest.

NEVER place shoulder belt under the child's arms or behind their back.

DO NOT use this booster seat if the top of your child's ears are above the top of the booster seat's headrest.

Storing Harness System

1

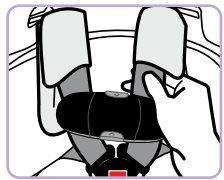

Fully Loosen Harness Straps

Place your hand between the harness cover and harness strap.

You may need to undo the harness cover or move the chest clip down.

Push down on harness release lever (through opening in pad) while pulling out on harness straps as shown.



2

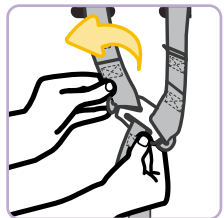

From Back of Seat, Remove Harness Strap Loops From Splitter Plate

3

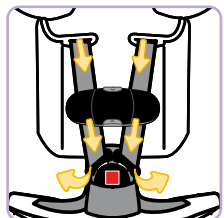

Unthread Harness

Unthread the harness strap from the harness slots, chest clip and buckle.

4

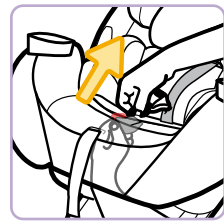

Recline Car Seat and Remove Buckle

Reach under between the base and the car seat. Rotate the buckle's metal retainer and push it up through the car seat.

5

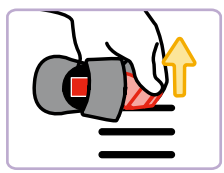

Pull Buckle with Buckle Tongues and Buckle Cover Out of Car Seat

Store the buckle with buckle tongues, buckle cover and chest clip in a safe place for future use.

6

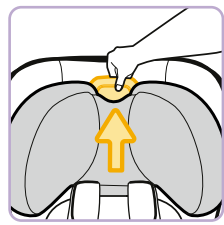

Adjust Headrest to Highest Position

7

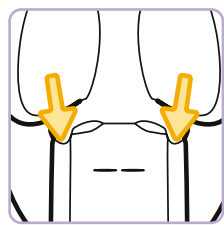

Undo Fasteners on Headrest Pad

Pull the two fabric tabs out of the slots on the headrest pad.

On select models: Unfasten and remove the EZ Out Harness Covers; see page 6.



8

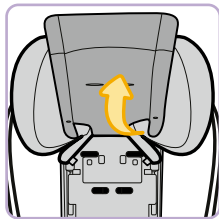

Lift Bottom of
Headrest Pad Up

9

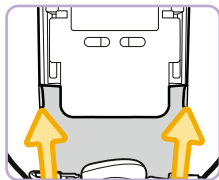

Undo Fasteners
on Seat Pad

Pull the two fabric tabs out of the slots on the sides of the backrest portion of the seat pad. Pull down the backrest pad.

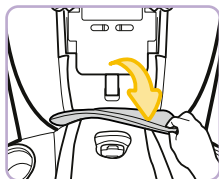

10

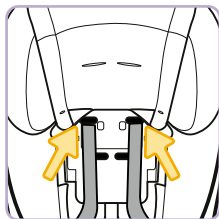

Rethread Harness Straps
into Top Shoulder
Harness Slots

DO NOT use the lower shoulder harness slots.

11

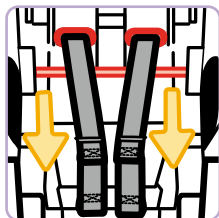

From Back of Seat,
Thread Harness Straps
Over Metal Bar

DO NOT twist harness straps.

12

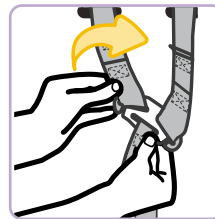

Attach First Harness
Strap Loops to
Splitter Plate

i

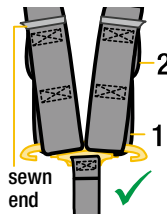

The sewn ends of the harness strap loops **MUST** face towards you.

DO NOT twist the harness strap or the harness adjustment strap.

Make sure the lower harness strap loops (labeled "1") are fitted completely on both sides of the splitter plate. The loops labeled "2" are for smaller infants only (see page 11).

13

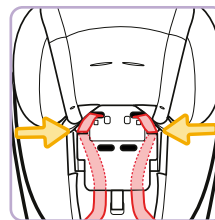

Thread Harness Straps
into Slots on
Sides of Headrest

14

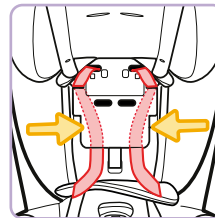

Place Harness Straps
Behind Headrest

15

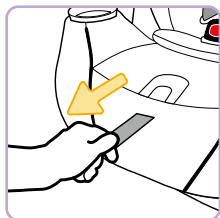

Tighten Harness

Remove any slack from the harness system.

16

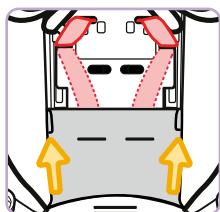

Redo Fasteners and Pull Down Headrest Pad

Reinsert the two tabs into the slots to reattach the backrest pad to the sides of the seat pad. Pull down the headrest pad and reinsert the two tabs into the slots.

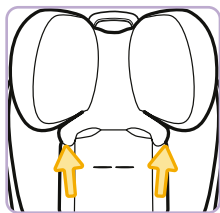

FINISHED!

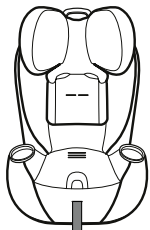

The car seat has been converted to the **Booster Seat Mode**.

See next page for **Booster Seat Use in Vehicle**.

1



Recline handle is at front of car seat.

Put Booster Seat into Position 1

Place the booster seat in the back seat. The booster seat **MUST** be flush against the back of the vehicle seat.

The booster seat **MUST** be upright. The vehicle seat back **MUST** be in the upright position, but you can adjust the angle slightly to better match the angle of the car seat. Refer to the vehicle owner's manual for how to adjust the vehicle seat back.

i

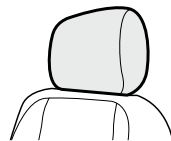

If your vehicle has a headrest that interferes with a flush car seat fit, check your vehicle owner's manual to see if it can be removed, adjusted, or if there are other possible seating locations for you to install.

2

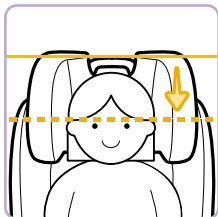

Have Child Sit in Booster Seat

The top of your child's ears should never be above the top of the booster seat's headrest.

3

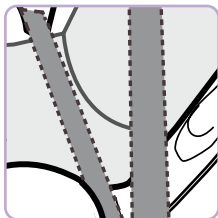

Position Lap Belt on Child

Route the lap belt portion of the vehicle belt through the **Booster Seat Belt Path** as shown. The lap belt should lay snugly across your child's hips; not on their stomach.

4

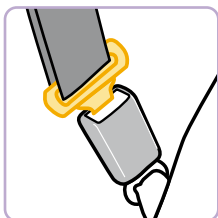

Buckle Vehicle Belt

Pull the shoulder belt up to tighten.

5

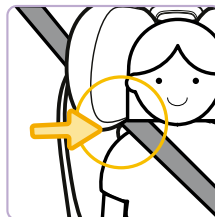
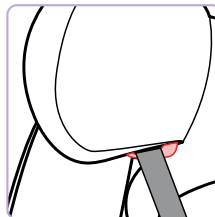

Position Shoulder Belt on Child

Thread the shoulder belt through the belt-positioning guide in the headrest.

Pull the shoulder belt up to tighten so that it lies snugly across the center of your child's shoulder and across their chest.

i



Check periodically to make sure your child has not moved out of position and loosened the shoulder belt.

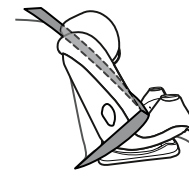

Keep the booster seat securely belted even when unoccupied.

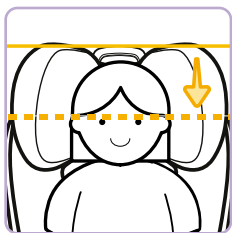

Check Head Position

The top of your child's ears should **never be above** the top of the booster seat's headrest.

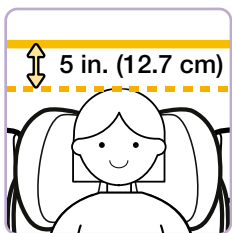

Check Car Position

DO NOT use the booster seat if your child's head is less than 5 in. (12.7 cm) below the roof of the car. Consult your vehicle manual for proper seatbelt usage.



Check Shoulder Belt Position

The shoulder belt should lay snugly across the center of your child's shoulder and across their chest.

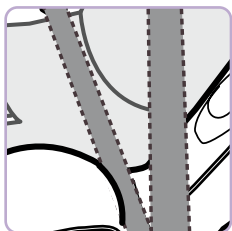

Check Lap Belt Position

The lap belt should lay snugly across your child's hips; **not on their stomach.**



You do not need to remove the harness system to remove the pad from the car seat.

DO NOT fully pull the harness strap out of the car seat. Leave it threaded in the hip harness slots. If removed, you will not be able to rethread it.

To remove accessories, see pages 5–7.

1

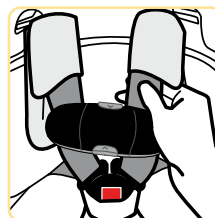

Fully Loosen Harness Straps

Place your hand between the harness cover and harness strap.

You may need to undo the harness cover or move the chest clip down.

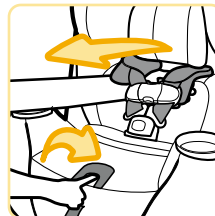

Push down on the harness release lever (through the opening in the pad) while pulling out on the harness straps as shown.

2

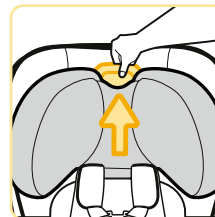

Adjust Headrest to Highest Position

3

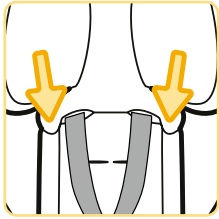

Undo Fasteners on Headrest Pad

Pull the two fabric tabs out of the slots on the headrest pad.

On select models: Unfasten and remove the EZ Out Harness Covers; see page 6.

4

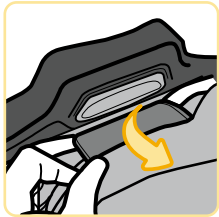

Locate Pad Fabric Tab Slots in Headrest

Pull the fabric tabs out of the slots in the headrest as shown.

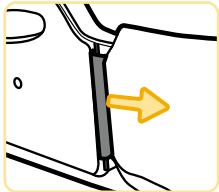

5

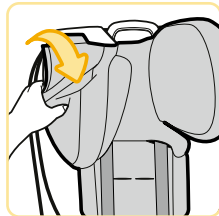

Gently Pull Headrest Pad Off Top of Headrest and around Harness Straps

6

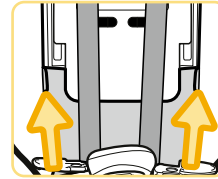

Undo Fasteners on Seat Pad

Pull the two fabric tabs out of the slots on the sides of the backrest portion of the seat pad. Pull down the backrest pad.

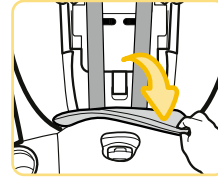

7

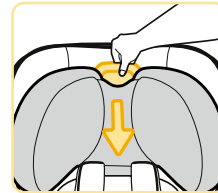

Lower Headrest to Middle Position

8

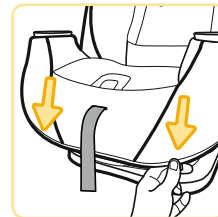

Undo Seat Pad Clips

Unfasten the two clips that secure the front of the seat pad to the bottom of car seat.

Rethread Harness

Thread the harness strap into the buckle, chest clip, and shoulder harness slots.

The harness strap ends go through the **back** of the buckle tongues and through the chest clip **front to back**.

From Back of Car Seat, Thread Harness Straps OVER Metal Bar

Attach Harness Strap Loops to Splitter Plate

11

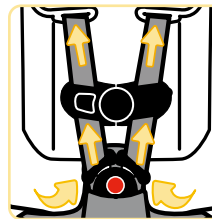

12

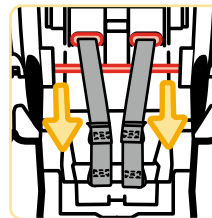

13

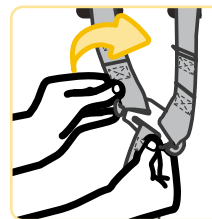

i

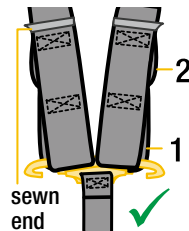

Make sure the lower harness strap loops (labeled "1") are fitted completely on both sides of the splitter plate. The loops labeled "2" are for smaller infants only (see page 11).

9

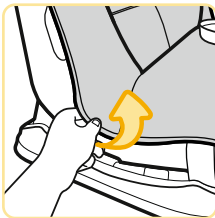

Pull Seat Pad Off Sides Car Seat

10

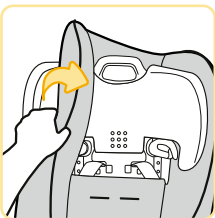

Pull Seat Pad Around Headrest and Off Car Seat

i

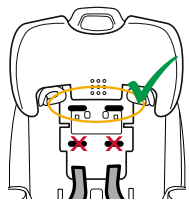

If the harness straps have been removed from the splitter plate, chest clip, and buckle, follow steps 11–13 and the info box on the next page to rethread them.

ONLY use the lower shoulder slots if you cannot achieve a snug harness fit for your child; see Harness System Adjustments for Smaller Infants on pages 9–12.

Cleaning Pad and Accessories

Machine wash separately with cold water on a gentle cycle. Make sure the harness covers are closed so the fastening strips are not exposed. **DO NOT** use bleach. Tumble dry separately for 10–12 minutes on low heat. Remove immediately.

Cleaning Harness Strap

Check the harness straps often for any wear or damage.

Spot clean using warm sudsy water and a damp cloth. Spilled food and liquids on the car seat may result in mold or bacterial growth over time. These spills could also attract insects or rodents.

Cleaning Buckle and Car Seat

Spot clean using warm sudsy water and a damp cloth. **DO NOT** submerge into water.

Installing Seat Pad Set

1. Lower headrest to middle of car seat.
2. Pull seat pad around headrest and onto car seat.
3. Secure the two clips at the bottom of the seat pad to the front of the car seat. Reinsert the two fabric tabs near the top of the backrest pad into the slots on the sides of the seat pad.
4. Pull headrest pad onto headrest.
5. Insert the two fabric tabs on the upper portion of the headrest pad into the slots on lower portion.
6. To install accessories, see pages 5–7.

⚠️ WARNING

DO NOT fully pull the harness strap out of the car seat. Leave it threaded in the hip harness slots. If removed, you will not be able to rethread it.

DO NOT use the child restraint without the seat pad or with damaged harness straps.

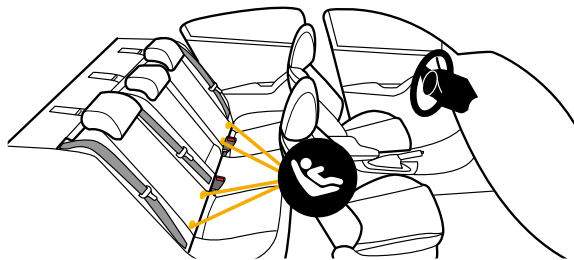

Your vehicle's features may be considerably different than those pictured here.

The lower anchors of **LATCH** (**L**ower **A**nchors and **T**ethers for **C**hildren) is a universal system for installing car seats without using vehicle seat belts. The LATCH: lower anchor belt can **ONLY** be used in vehicles that have the lower anchor bars installed in designated seating positions. Most vehicles manufactured after September 2002 are equipped with LATCH: lower anchor bars. Check your vehicle owner's manual to see which seating positions may be equipped with LATCH: lower anchor bars.

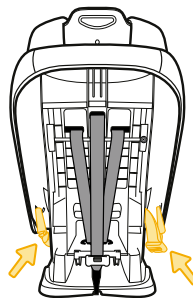

Lower Anchor Belt Storage Location

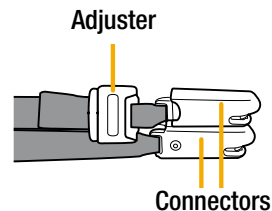

Lower Anchor Belt Parts

To Remove Lower Anchor Belt from Storage Location on Car Seat

Press the release button on each connector, then pull the connectors off of storage attachments.

continued on next page

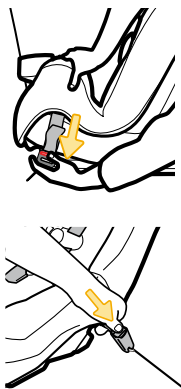

To Remove Lower Anchor Belt from Vehicle's Lower Anchor Bars

1. Remove the tension from the belt by pushing down on the side of the car seat with the adjuster.
2. Then press the adjuster's button to loosen the belt.
3. Press the release button on each connector, then pull the connectors out of the vehicle seat.

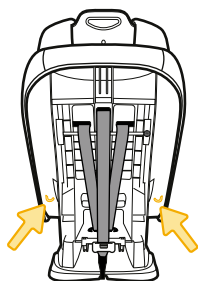

To Store Lower Anchor Belt

The lower anchor belt **MUST** be properly stored in its storage location when:

- Using the vehicle belts to install the car seat; **OR**
- Using the **Booster Seat Mode**; **OR**
- The car seat is not installed in a vehicle.

Secure the connectors to the attachments in the storage location as shown. Gently tighten the belt to remove slack.

⚠ WARNING

DO NOT use both the lower anchor belt and vehicle belt at the same time.

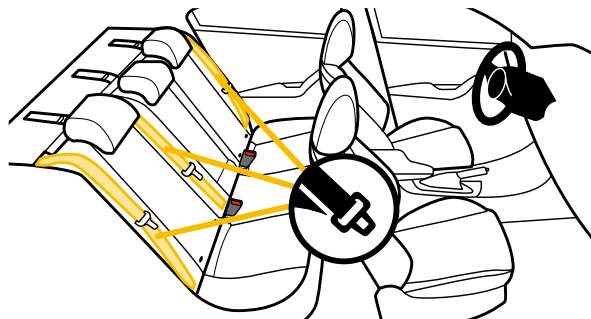

Your vehicle's features may be considerably different than those pictured here.

If LATCH: lower anchors are not an option or if your child weighs more than **50 lb (22.7 kg)** in **Forward-Facing Mode**, you **MUST** use the vehicle seat belt system to install the car seat.

Not all vehicle belts and seating positions will work with car seats. Please go through the following steps to understand how to lock a car seat in Rear-Facing Mode or Forward-Facing Mode with a vehicle belt.

1



You **MUST** Review Your Vehicle Owner's Manual

Your vehicle owner's manual will let you know which vehicle belts and seating positions car seats can be installed in.

2



Check How This Car Seat Will Be Locked Into Place

The vehicle belt **MUST NOT** loosen after tightening.

This means there needs to be a way to lock the vehicle belt.

The ways this can be done are:

- By using the seat belt's retractor (see step 3); **OR**
- By using the seat belt's latch plate (see step 4).

3

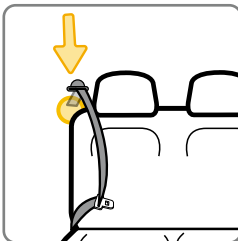

Check Retractor

Retractors pull seat belts into stored positions and lock the belt to hold passengers in place.

See the next page for some common types of vehicle belt retractors that will work with this car seat.

Switchable Retractor

(most vehicles have this type)

This retractor can be switched to a locking mode.

You **MUST have the retractor in the locking mode** to use the seat belt with this car seat.

Switching to locking mode: Slowly pull the shoulder belt all the way out, then let it go back in **1–2 in.** (2.5–5 cm).

As it goes back in, you will most likely hear a ratcheting sound.

Gently pull the belt to see if it has locked. You will not be able to pull any more belt out if the lock has engaged.

Automatic Locking Retractor

This retractor always locks.

It will automatically lock after slowly pulling the seat belt out at least halfway and letting the belt go back into the retractor **1–2 in.** (2.5–5 cm).

Emergency Locking Retractor

See Step 4 Check Latch Plates

If the retractor does not lock, it is most likely an Emergency Locking Retractor. These retractors only lock during a sudden stop or collision.

You will need to determine if your seat belt's latch plate can lock the belt. See step 4, Check Latch Plates.

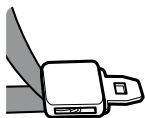

Locking
Latch
Plate

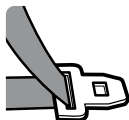

Sliding
Latch
Plate

Check Latch Plates

Latch plates are the part of the seat belt that goes into the buckle.

To see if the latch plate locks:

1. Buckle vehicle belt.
2. Slowly pull up on the lap portion of the vehicle belt.

If the vehicle belt does not slide through the latch plate, it's locked.

If the vehicle belt slides through the latch plate, it is a **sliding latch plate**.

Sliding latch plates easily slip between the lap and shoulder portions of the belt.



If you have an Emergency Locking Retractor with a Sliding Latch Plate, you **MUST** use a locking clip.

Please contact us for one, see the back cover of the manual.

Never Use the Following With This Car Seat:

- Emergency Locking Retractor Lap Only Belt
- Inflatable Seat Belts

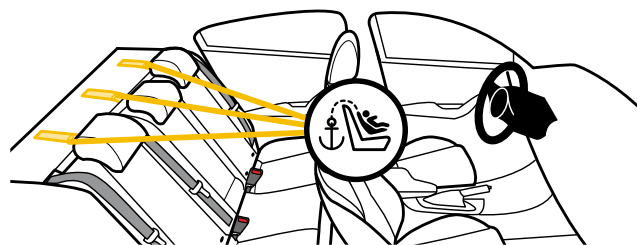

Your vehicle's features may be considerably different than those pictured here.

When anchors are available, you **MUST always attach, adjust, and secure the tether (top anchorage) strap** when installing the car seat in the **Forward-Facing Mode** with internal harness. Tethers improve the installation and stability of car seats and reduce the risk of injury. Attach the tether hook to the tether anchor designated by your vehicle manufacturer for that seating position. Check your vehicle owner's manual for more information. If the seating position does not have a tether anchor, use a different seating position or see your dealer or a qualified mechanic and have one installed.

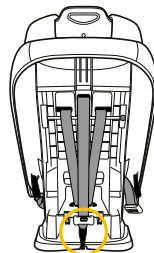

Storing Top Tether Strap

The tether strap **MUST** be properly stored in its storage location when:

- Installing in **Rear-Facing Mode**; **OR**
- Using the **Booster Seat Mode**; **OR**
- The car seat is not installed in a vehicle.

Attach the tether hook to its storage location as shown. Gently tighten to remove slack.

⚠️ WARNING

Using this child restraint without the tether strap anchored as required by the manufacturer would be a misuse of the child restraint and, in a sudden stop or crash, could result in serious injury or death. Serious injury can include paralysis and/or permanent brain damage.

DO NOT fasten multiple tether hooks on the same tether anchor in the vehicle.

⚠️ WARNING

NEVER take your child out of the child restraint while the vehicle is moving.

NEVER leave your child unattended.

Placing your child in a hot child restraint may result in burns.

DO NOT use a child restraint with damaged or missing parts.

DO NOT use a child restraint with cut, frayed, or damaged harnesses.

DO NOT substitute parts or try to modify the child restraint in any way. **DO NOT** lubricate buckles and fasteners.

DO NOT use any child restraint accessory except those approved by Dorel Juvenile Group.

NEVER allow any child to play with this child restraint; it is not a toy.

DO NOT remove or cover up any of the warning labels or other labels on the child restraint.

This child restraint has been certified for use in passenger vehicles. **DO NOT** use in a boat, on a motorcycle or in a cargo van or bus where there are no seat belts or tether anchors.

Read all instructions for additional warnings.

⚠️ WARNING



NEVER place a child rear-facing in a seating position with an active frontal air bag.

Check the vehicle owner's manual for more information about air bag/child restraint use.



Use the child restraint only on vehicle seats that face forward.



DO NOT use on seats that face the sides or rear of the vehicle.

For vehicles without a back seat, refer to your vehicle owner's manual.



According to accident statistics, children are safer when properly restrained in the rear seating positions than in the front seating positions.

Rear seating positions are statistically safer, whether you have air bags, advanced air bags, or no air bags at all.

If you are not sure where to place the car seat in your vehicle:

- Consult your vehicle owner's manual; **OR**
- Contact Dorel Juvenile Group Consumer Care Department; **OR**
- Visit your local Child Passenger Inspection Station. Go to <https://www.nhtsa.gov/vehicle-safety/car-seats-and-booster-seats> to find your closest station.

To avoid your child being seriously burned, take the following precautions:

- Park in the shade or where the sun does not directly hit the car seat.
- Cover the car seat with a sheet or blanket when not in use.
- Check for hot seat and buckles before placing child in car seat.

To help protect your vehicle seat's upholstery from damage: you may use an accessory approved by Dorel Juvenile Group or a single layer towel underneath and behind car seat.

⚠ WARNING

Check the vehicle belt or lower anchor belt before each use. Use only if the belt can be tightened properly and locked securely in place.

Even when unoccupied, this child restraint **MUST** be firmly secured to the vehicle with the lower anchor belt or with the vehicle seat belt.

Even when unoccupied, this booster seat **MUST** be firmly secured to the vehicle with the vehicle seat belt.

In a crash or sudden stop, an unsecured child restraint or booster seat could injure occupants.

DO NOT risk your child's safety.

To keep your child as safe as possible, Dorel Juvenile Group strongly recommends replacing the car seat even after a minor crash; even if it was not occupied at the time.

Replacement After a Minor Crash

The National Highway Traffic Safety Administration states that for a crash to be considered minor **ALL of the following MUST be true:**

- Vehicle able to drive away from the crash site; **AND**
- Vehicle door nearest the car seat was not damaged; **AND**
- No passengers were injured; **AND**
- Airbags did not deploy; **AND**
- There is no visible damage to the car seat.

If the crash your car seat was involved in meets **ALL** the criteria, you may not need to replace the car seat.

If one or more of these criteria are not true or if you are uncertain of any of your answers, replace the car seat immediately.

Replacement After a Moderate to Severe Crash

You **MUST** replace this car seat if it has been in a moderate to severe car crash.

This car seat is intended to protect a child in a single crash. During a crash, the car seat and all of its parts absorb crash energy which can deform or weaken it. Damage is not always visible. A damaged car seat **MUST** be replaced immediately.

Expiration

On the side of the car seat there is a date of manufacture label as shown.

DO NOT use this car seat more than 10 years after the date of manufacture.



0515079 Tear Off and Mail This Part or Register Online 4348-0081D

Consumer: Just fill in your name, address and email. Please print (use dark ink).

Your Name

Your Street Address

City State Zip Code

Email Address (optional)

Model Number
AB123CDE

Model Name
Brand Car Seat

Manufacture Date
2024/05/16

L#11 B265035

Example of model number, manufacture date, and line code.

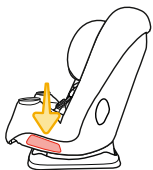

If you don't have the card or if your address changes, you will find the model number, manufacture date, and line code on the label located on the side of the car seat.

Please complete the postage-paid registration card that came with your child restraint, and send it to us.

Child restraints could be recalled for safety reasons.

You must register this restraint to be reached in a recall.

Send your name, address, e-mail address if available and the restraint's model number and manufacturing date to:

Dorel Juvenile Group

Attn: Consumer Care
P.O. Box 2609
Columbus, IN 47202

or call 1-800-951-4113 or register online at
<http://www.djgusa.com/registration/carseat/us>.

For recall information, call the U.S. Government's Vehicle Safety Hotline at 1-888-327-4236 (TTY: 1-800-424-9153), or go to www.NHTSA.gov.

This restraint is certified for aircraft use when used with the internal harness.



Rear-Facing Aircraft Installation

Follow the vehicle belt installation steps on pages 21–27.



Forward-Facing Aircraft Installation

Follow the vehicle belt installation steps on pages 33–38, skipping the tether strap steps.



Booster Seat

This restraint is not certified for aircraft use, when used as a booster seat, because aircraft seats do not have shoulder belts.

Install the car seat in a window seat to avoid blocking the aisle. If the aircraft lap belt is too short, ask the flight attendant for a belt extender.

Use only on forward-facing aircraft seats. Contact the airline for their specific policies.



Some airlines may ask to see a label stating that this car seat is certified for aircraft use.

There is an airplane certification label located on the side of this car seat as shown.

⚠️ WARNING

You **MUST** store the lower anchor belt and tether strap when installing with aircraft belts.

Dorel Juvenile Group, Inc. (DJG) warrants this product to the original retail purchaser as follows: This product is warranted against defective materials or workmanship for one year from the date of original purchase.

An original receipt is required to validate your warranty.

DJG will, at its option, provide replacement parts or replace this product. DJG reserves the right to substitute if the part or model has been discontinued.

To make a claim under this warranty, please contact our Consumer Care Department by phone: 1-800-544-1108 or text: 1-812-652-2525. Our hours of operation are from 8:00 a.m. to 6:00 p.m. EST Monday through Thursday and from 8:00 a.m. to 4:30 p.m. on Friday.

Proof of purchase is required and shipping charges are the responsibility of the consumer.

Warranty Limitations: This warranty does not include damages which arise from misuse or abuse of this product.

Limitation of Damages: The warranty and remedies as set forth are exclusive and in lieu of all others, oral or written, expressed or implied. In no event will DJG or the dealer selling this product be liable to you for any damages, including incidental or consequential damages, arising out of the use or inability to use this product.

Limitation of warranties and other warranty terms and state law rights: Any implied warranties, including implied warranties of the merchantability and fitness for a particular purpose, shall be limited to the duration and terms of the express written warranty.

Some states do not allow limitations as to how long an implied warranty lasts or the exclusion or limitation of incidental or consequential damages, so the above limitations may not apply to you.

This warranty gives you specific legal rights, and you may have other rights, which vary from state to state. Neither DJG nor the dealer selling this product authorized any person to create for it any other warranty, obligation, or liability in connection with this product.

Please note: Our product warranty only applies when purchased from an authorized Maxi-Cosi retailer. The origin of products not purchased through these authorized retailers is unknown and could be counterfeit.

We cannot support products from an unknown origin as we cannot verify the handling or condition of such merchandise. We maintain a strong network of authorized retailers to ensure you are purchasing safe and complete products.

Fulfillment by a third party does not guarantee you are purchasing from one of these authorized retailers. Pricing which is inconsistent with the majority of retailers is a strong indication that the retailer is not authorized, as we have a consistent price offering across all authorized retailers.

If you are unsure of the authorization status of a retailer you are considering purchasing from, or have purchased from, you can check www.maxicosi.com/us-en/find-a-retailer; or call our Consumer Care Department at 1-800-544-1108; or text us at 1-812-652-2525.