

# Viking Use & Care Manual

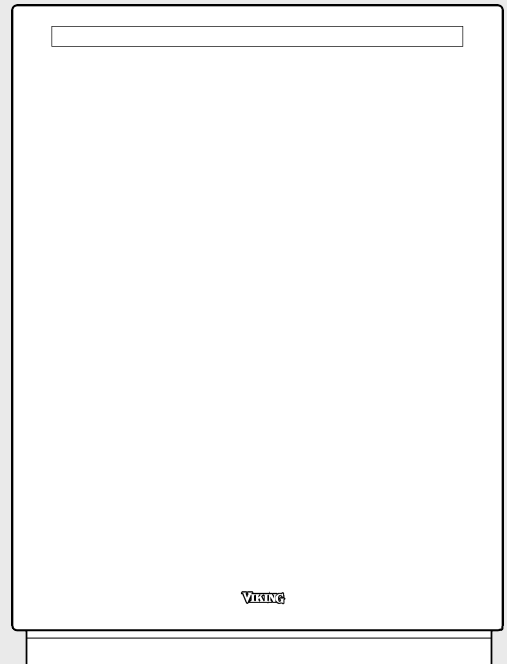

Designer Series Undercounter Dishwashers

# CONGRATULATIONS

Your purchase of this product attests to the importance you place upon the quality and performance of the major appliances you use. With minimal care, as outlined in this guide, this product is designed to provide you with years of dependable service. Please take the few minutes necessary to learn the proper and efficient use and care of this quality product.

We appreciate your choosing a Viking Range Corporation product, and hope that you will again select our products for your other major appliance needs.

## TABLE OF CONTENTS

	Page
Important Safety Instructions . . . . .	.2
Dishwasher Features . . . . .	.3
What Can Be Washed . . . . .	.4
Preparing Dishes . . . . .	.5
Loading the Dishwasher . . . . .	.5
Water Temperature . . . . .	.6
Dishwasher Detergents . . . . .	.7
Water Softener . . . . .	.7
Rinse Aids . . . . .	.8
Energy Saving Tips . . . . .	.9
How to Operate . . . . .	.9
Safety . . . . .	.11
Maintenance . . . . .	.11
Troubleshooting . . . . .	.12
Poor Dishwashing Results . . . . .	.14
Service Information . . . . .	.17
Warranty . . . . .	.18

## IMPORTANT SAFETY INSTRUCTIONS

**WARNING:** To reduce the risk of fire, electrical shock, or injury when using your dishwasher, follow basic precautions including the following:

1. Read all instructions before using the dishwasher.
2. This dishwasher must be properly connected to electricity and water.
3. Use the dishwasher only for its intended function.
4. Use only detergents and rinse agents recommended for use in dishwasher, and keep them out of reach of children.
5. When loading items to be washed locate sharp items so that they are not likely to damage the door seal and load sharp knives with the handles up to reduce the risk of cut-type injuries.
6. **DO NOT** wash plastic items unless marked "dishwasher safe" or the equivalent.
7. **DO NOT** operate your dishwasher unless all enclosure panels are properly in place.
8. **DO NOT** tamper with the controls.
9. **DO NOT** abuse, sit on or stand on the door or dish rack of the dishwasher.
10. **WARNING:** To reduce the risk of injury, use extreme caution when opening the unit especially during an operating cycle. Hot steam may be released when door is opened.
11. To reduce the risk of injury, do not allow children to play in or on a dishwasher.
12. If hot water has not been used recently (usually two weeks or longer), hydrogen gases may buildup in the water heater and the hot water pipes. **HYDROGEN GAS IS EXPLOSIVE.** To prevent injury or damage, before using your dishwasher, turn on all hot water faucets and allow water to run for several minutes. This will allow gases to escape. Do not smoke or use any open flames near the faucet while it is open.
13. When discarding an old dishwasher, always remove the door to prevent accidental entrapment.
14. To prevent electrical shock, disconnect electrical power supply to dishwasher before attempting to service.
15. **It is your responsibility to be sure your dishwasher:**
  - Has been properly electrically grounded and installed by a qualified installer.
  - Has been installed where it is protected from the elements.
  - Has been installed on a floor strong enough to support its weight.
  - Has been properly connected to electricity, water and drain and is properly maintained.
  - Has had all hang tags and temporary labels removed.

## SAVE THESE INSTRUCTIONS



# CONTROL PANEL

DFUD042

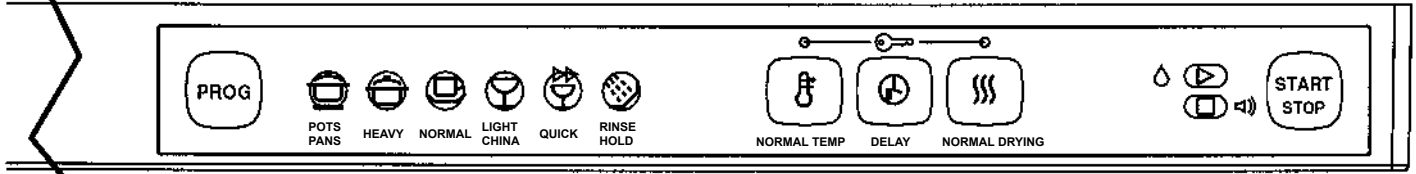

DFUD142

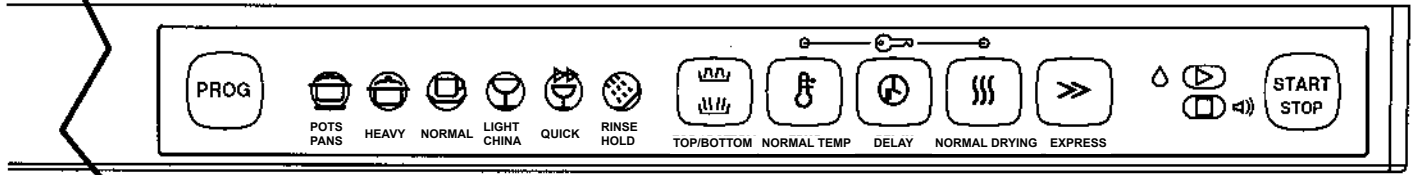

# DISHWASHER FEATURES

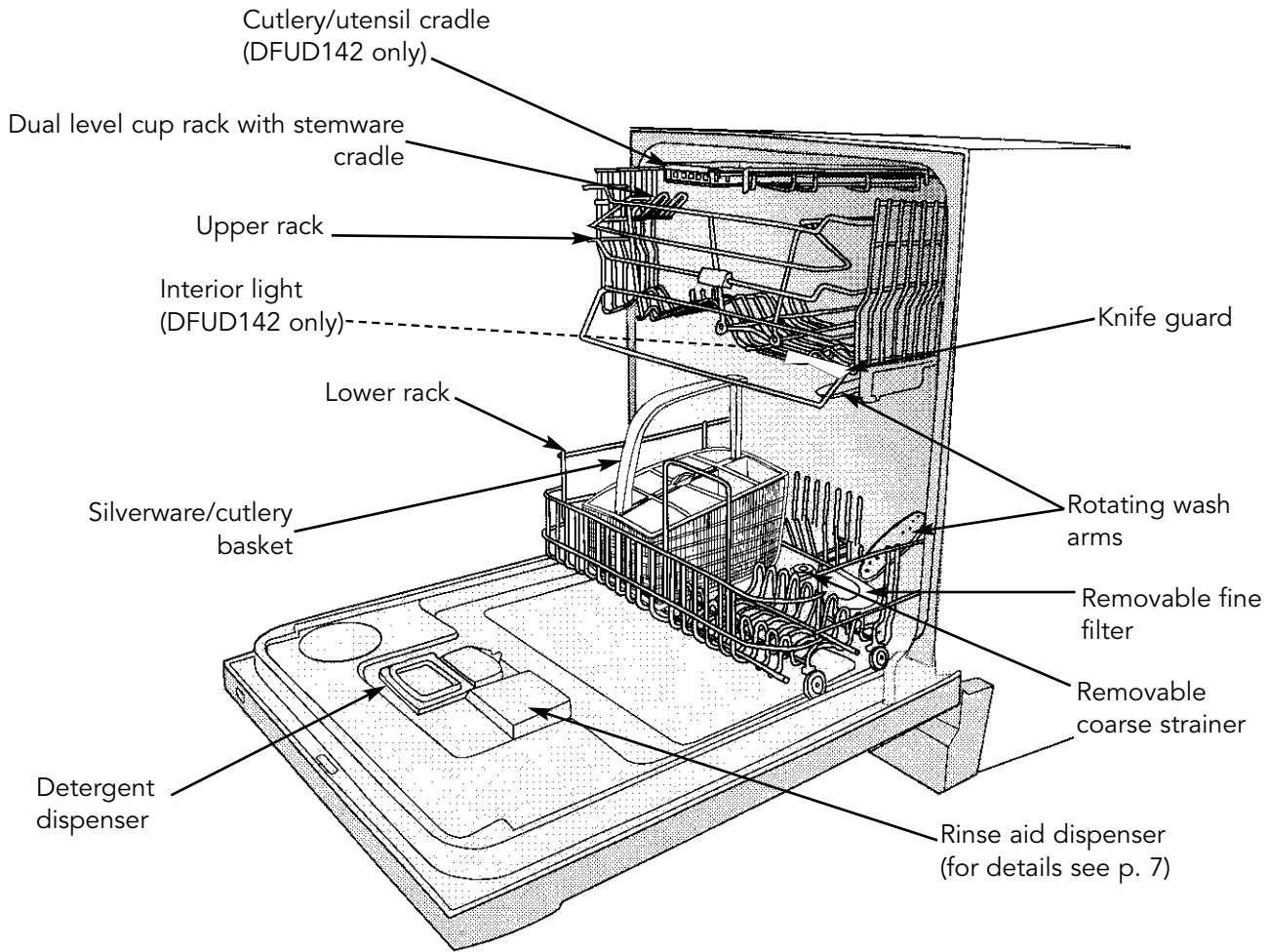

## WHAT CAN BE WASHED

Most household goods such as plates, saucepans, and flatware can be machine washed. If you are unsure, check with the manufacturer or, if this is not possible, wash one item of a set over an extended period and then compare it with the rest of the set. The user is responsible for what is washed in the dishwasher.

MATERIAL	DISHWASHER SAFE	INFORMATION
Aluminum	Yes, with caution	Anodized aluminum may fade or darken. Patches and discoloration may appear, but these can be removed with steel wool. Remember not to position aluminum utensils so that they can come in direct contact with the dishwasher detergent since this may result in black spots and small erosion holes.
Cast Iron	No	The seasoning is lost and the iron rusts. Should be handwashed.
China Stoneware	Yes, with caution  No	China without decor or with decor protected by glaze is dishwasher safe. Remember, however, to place the objects so they are not in contact with each other. If they come in contact, they could be damaged. China with a pattern on top of the glaze, or with gold leaf decor may fade. Check with the manufacturer. If this is not possible, wash one item of a set over an extended period and then compare it with the rest of the set.  Antiques and very delicate china should not be washed in the dishwasher.
Crystal	Yes	Place the items so that they cannot fall over or knock against each other while being washed. Certain types of lead crystal may etch if they are machine washed. Check with your supplier. Refer to china above for colored patterns or gold leaf decor. Use a low wash temperature. Antiques and very delicate china should not be washed in the dishwasher.
Dirilyte	No	Gold-colored flatware can become discolored.
Glass	Yes	Milk-glass may become discolored.
Flatware with bonded handles	No	Certain types of adhesives cannot withstand machine washing and may loosen.
Sharp kitchen carving knives	No	May become dull if washed in very hot water or allowed to contact other items during the washing process. Wood handles may also warp, crack or loosen.
Pewter	No	Pewter tarnishes.
Plastic (disposable)	No	Cannot withstand machine washing.
Plasticware	Yes	If the item is not marked "Dishwasher safe", test one of the items before the whole set is washed. Place plastic items in the upper rack. Use drying without heat.
Stainless steel	Yes, with caution	Rinse the items if they are not going to be washed immediately. Salty or acidic foods can stain if left on. Dry dishwasher detergent can also produce black marks which are difficult to remove. Do not let copper items come in contact with stainless steel. Do not mix different types of stainless steel.
Silver and silver plate	Yes, with caution	Rinse the items if they are not going to be washed immediately. Salty or acidic foods can stain if left on. Dry dishwasher detergent can also produce black marks which are difficult to remove. Do not put in same basket with stainless steel. Contact between the metals can damage silver. Do not wash copper utensils in the same load. Silver may get a brown film. Adhesive used to attach some hollow-handle knives can loosen.
Non-stick coatings	Yes	After washing, wipe the non-stick coating with vegetable oil to keep it from losing non-stick quality.
Tin	No	Can rust.
Wood	No	Check manufacturer's recommendation. Wood can warp, crack or lose its shape with any kind of washing

## PREPARING DISHES

It is not necessary to rinse normal food soils off the dishes before putting them in the dishwasher although larger solid particles, such as bones, seeds, skins, pits and toothpicks should be removed.

If you are not going to run the dishwasher immediately after loading, it is best to rinse salty and highly acidic foods off stainless steel, silver and silverplate flatware. Prolonged contact of foods, including lemon juice, salt, vinegar, mustard, mayonnaise and salad dressings with stainless steel can cause corrosion (pitting).

If dishes have baked on or burned on foods, they may need to be soaked in a solution of one tablespoon dishwasher detergent per quart of hot water. (Do not soak silver items, it will cause black spots on silver.)

## LOADING THE DISHWASHER

### THE UPPER RACK

The upper rack is best for glasses, cups, bowls, small plates and saucers. To provide best results, load all items so that the force of the water and detergent reaches soiled surfaces. The upper rack of the DFUD142 has two dual level cup racks with stemware cradle. Arrange stemware between prongs so that it cannot move easily. The DFUD142 also has adjustable tines and a divided cup shelf. Do not let china, crystal, and other delicate items touch each other during dishwasher operation. Make sure small plastic items are held firmly in place. Small bowls, pans and other utensils can also be placed in the top rack. Make sure the movement of the wash arm is not blocked by items hanging below the rack. Long utensils may also be placed in the upper rack. Make sure knives do not touch other items or they may become dull. Also, make sure the sharp edges do not damage the graphite nylon coating of the rack.

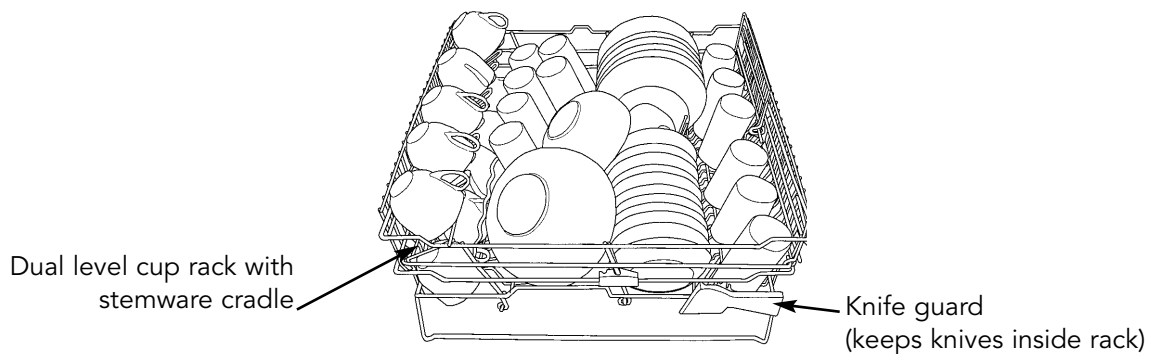

### THE LOWER RACK

Place dinner plates, smaller plates, serving plates, larger bowls and pans in the lower rack. The lower wash arm sprays up with a more powerful pressure to clean more heavily soiled items. Make sure pot handles and other items do not stop rotation of either wash arm by hanging below the rack or by sticking up too far. The fold down tines in the DFUD142 provide space for large items such as pots and pans. Securely place heavily soiled cookware face down in the rack.

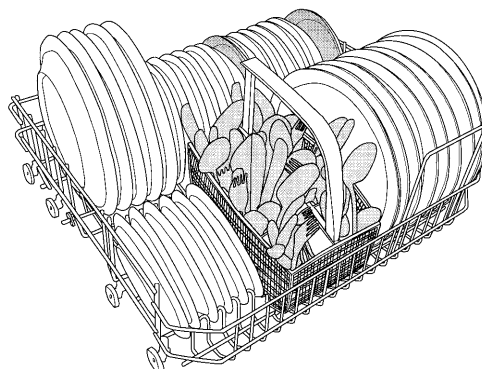

## THE SILVERWARE/CUTLERY BASKET AND LARGE CUTLERY/UTENSIL CRADLE

Arrange flatware in the silverware basket with handles down. Sharp or pointed items, such as knives, should be put in with the point down to protect your hands. Distribute items evenly and mix knives, forks and spoons so that items will avoid nesting. FOR BEST CLEANING RESULTS, ALWAYS PLACE FORKS AND SPOONS WITH EATING PORTION UP AND HANDLES DOWN. In the center of the basket is a small items lid. It can be used to cover either compartment on each side of the handle. When not use, the small items lid is hidden in the middle of the silverware basket. Do not put sterling silver or silverplate flatware in the same compartment with stainless steel. Contact between the metals can damage silver. It is also not advisable to place stainless steel of different qualities close to each other. Load sharp knives so that they are not likely to damage the door seal. The separate cutlery/utensil cradle at the top of the tank is used for long knives or spatulas that might fall or extend through the bottom of the basket.

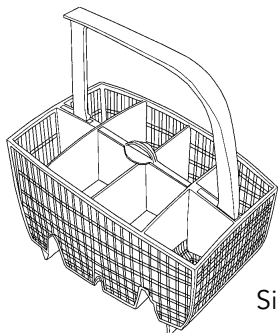

Silverware/cutlery basket

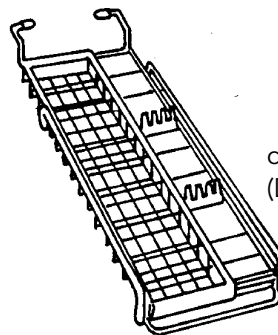

cutlery/utensil cradle  
(DFUD142 only)

## INTERIOR LIGHT (DFUD142 only)

For lighted random loading, there is an interior halogen light on the left side of the tank. Lighted loading allows better visibility and comes on when door is opened provided the power switch has been turned on. Light bulb replacement should not be necessary, but if the need should arise, please contact an authorized service agent.

## EXTRA QUIET OPERATION HINTS

Your dishwasher has been designed and engineered to not only give superior cleaning results, but also to operate extremely quiet. To avoid any extra clattering or thumping noises during operation:

- Keep sink drain plugs inserted during dishwasher operation to prevent noise transfer through drains.
- Load dishes so they do not touch each other.
- Make sure light weight items are secured in the rack.
- Make sure pot lids and handles, pizza pans, cookie sheets, etc., do not touch interior walls or interfere with either of the wash arm's rotation.

## WASH TEMPERATURE

	<u>DFUD042 / DFUD142</u>
Watts	1200
Heated Water Temp.	85°F (29°C) to 170°F (77°C)

Hot water dissolves and activates dishwashing detergents, dissolves grease on dishes and helps glasses dry spot free. If the incoming water is extremely cold due to unusually cold temperatures outside, if you have recently done laundry or run hot water for showers, or if your water travels a long distance from the hot water heater to the dishwasher, the running time of the dishwasher may be longer to allow for heating the water.

## CHECKING THE WASH TEMPERATURE

To get the best possible results, the water is recommended to be at least 120°F (49°C) . However, it does not matter if temperature of the incoming water is lower since the dishwasher has an element which heats the water to the required temperature. You can, however, check that the temperature of the incoming water is not too high as follows:

1. Turn on the water faucet to the highest temperature possible, and let the water run into the sink.
2. Place a dish or other object in the sink and let the water fill it and run over for at least a minute.
3. Measure the temperature with a meat thermometer or similar device. The temperature should not be higher than 140°F (60°C).
4. If the temperature is too high, adjust the setting on the hot water heater.

# DISHWASHER DETERGENT

## (Use only automatic dishwasher detergent)

Use only a detergent designed for an automatic dishwasher. Never use soap, laundry detergent or handwashing detergent in your dishwasher, as they are too mild and will cause severe over-sudsing. The foam product prevents the dishwasher from working properly and may cause the dishwasher to leak.

**WARNING: Dishwasher detergent is corrosive. Keep out of reach of children. If swallowed, drink plenty of water or milk. Do not induce vomiting. Seek medical advice without delay. If dishwasher detergent gets into the eyes, rinse immediately with plenty of water.**

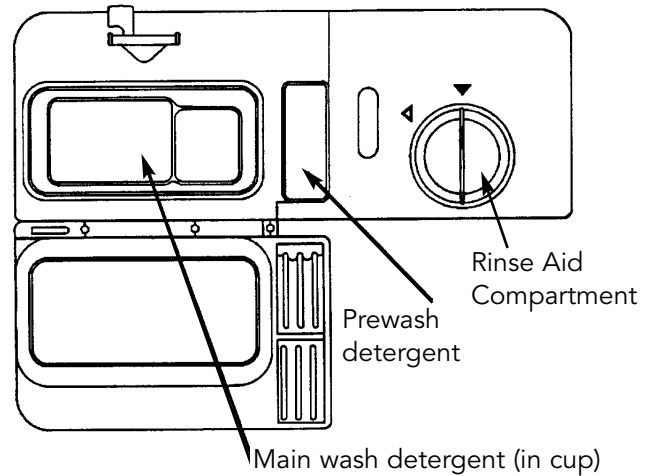

### STORING THE DETERGENT

For best results, keep your detergent container tightly closed after each use, out of reach of children and stored in a cool, dry place. **Storage under the sink is not advisable for powdered detergent, because this area is generally too warm and moist to keep detergent fresh.**

### Dishwasher tablets

Halve the tablet if it is difficult to close the dispenser cover. There is a risk that the dishwasher detergent will not break down properly to give the correct dosage if the cover is tight and cannot be opened correctly.

### 3in1 Combined Detergent

Read through the directions for these products carefully. If anything is unclear, contact the dishwasher detergent manufacturer.

### HOW MUCH DETERGENT TO USE?

The amount of detergent you use depends on the hardness of the water and on the cycle you select. Generally, only one tablespoon of detergent is needed for a normal load.

### HARDNESS OF WATER

Water has a different "hardness", or mineral content, in different locations. The hardness is measured in grains per gallon (gpg). Find out your water's hardness by asking your local water department, county extension agent or water softening company. Ask how many "grains" of hardness are in your water.

The harder the water is, the more detergent you need. For the recommended detergent amounts to use with your water, follow the guidelines in the chart. With hard water, you need more detergent to get dishes clean. With soft water, you need less detergent.

Water Hardness Grains per Gallon	Amount of detergent (Powder or Liquid)
Soft Water 0-3 gpg	1 teaspoon to 1 tablespoon
Medium Hard Water 4-8 gpg	2 1/2 tablespoons
Hard Water 9-above gpg	3 tablespoons

Too much detergent with soft water can cause "etching", a permanent cloudiness of glassware. If you have "hard" water, the dishes as well as the dishwasher itself may accumulate a gray deposit after some time. This deposit can be remedied by using a mild citric acid solution instead of detergent in the heavy wash program.

## RINSE AIDS

A rinse aid causes water to flow off the dishes quicker, preventing droplets that dry as spots and making drying performance better. Rinse aids come in solid and liquid forms. Your dishwasher's rinse aid dispenser uses the liquid form. For the best results, use a liquid rinse aid only if you have moderately hard to hard water. Rinse aids used with soft water can cause a cloudy film on dishes.

### FILLING THE RINSE AID DISPENSER

Drying will usually be better if you use a rinse aid. To fill the dispenser, open the cap and pour the rinse aid into the dispenser up to the knob for dosage setting. The dispenser will hold approximately four ounces of liquid rinse aid.

### ADJUSTING THE DOSAGE OF RINSE AID

The rinse aid dosage is set by the manufacturer and is dispensed automatically into the final rinse. If necessary, the rinse aid dosage can be adjusted by inserting a screwdriver inside the filler hole where the adjustment device is set on "1". It is recommended that the dial is only adjusted one number at a time. **NOTE:** Too much rinse aid is not advisable as this might result in the formation of foam, especially if the dishwasher is connected to cold water supply.

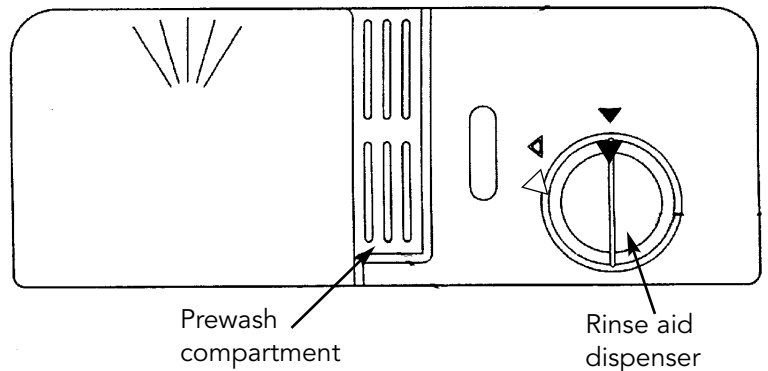

**NOTE:** The dishwasher has an indicator on the control panel that displays when the rinse aid dispenser is almost empty. After refilling the dispenser, there may be a small delay before the indicator goes out.

## CHILD SAFE FEATURE (DFUD142 only)

As a safety measure, the dishwasher can be programmed to prevent a child from accidentally starting the machine or changing the program. This unit can be programmed not to start unless the Temperature and Drying buttons are held down simultaneously. To program this feature, follow the steps below:

1. Turn off the power to the machine.
2. Simultaneously press and hold down the Normal Temp and Normal Drying buttons as you turn on the power to the machine. The Normal Temp, Normal Drying and Start buttons will flash.
3. Release the buttons.
4. Press the Program button. The Pots/Pans button will glow to indicate the button lock is activated.
5. Press the Start/Stop button to store settings.

Once the child-safe feature is active, the Normal Temp and Normal Drying buttons will flash whenever pressing any of the buttons. To temporarily deactivate the button lock, simultaneously press the Normal Temp and Normal Drying buttons. The lock will reactivate automatically in three minutes. To completely deactivate the button lock, repeat the steps above. The Pots/Pans button will go out to indicate the button lock is off.

## Activating the End-of-Program Signal

This unit can be programmed to emit a short signal when the program is finished. To program this feature, follow the steps below:

1. Turn off the power to the machine.
2. Press and hold down the Delay Start button as you turn on the power to the machine. The Delay Start button will flash.
3. Release the button.
4. Press the Program button. The Pots/Pans button will glow to indicate the end-of-program signal is activated.
5. Press the start/stop button to store the settings.

To deactivate the signal, repeat the steps above. The Pots/Pans button will go out to indicate the signal is off.

## ENERGY SAVING TIPS











1. Only start a wash when the machine is completely full.
2. Make sure that for normal day-to-day washing the low temp setting is selected.
3. Select the cycle without the Extra Dry option.
4. If you plan to wash dishes right away, there is no need to prewash. Simply scrape, load, and wash.
5. Use the Pots/Pans and Heavy programs only for heavily soiled dishes.

## HOW TO OPERATE

### BEFORE OPERATION REVIEW

1. Load the dishes properly.
2. After pushing the baskets back inside the unit, manually rotate the upper and lower spray arms to be sure they turn freely
3. Make sure there is rinse aid in the dispenser. Add rinse aid if needed.
4. Add proper amount of detergent. Close the detergent compartment cover.
5. Press the POWER button on the left side of the control panel.
6. Select the desired wash program and option(s). A red light appears in or above the selected cycle/option.
7. Press start. The start symbol will flash to indicate the unit is ready.
8. Close the door tightly until you hear a click. Otherwise, the dishwasher will not start.

## WHICH CYCLE / OPTION TO SELECT (Refer to Control Panel - p. 3)

Wash Cycles	Options
 <p><b>Pots/Pans</b> For heaviest soiled loads, such as pots and pans, casserole dishes, etc. This cycle uses high water temperature.</p>	 <p><b>Top/Bottom Rack</b> Allows you to choose to wash only the top rack, bottom rack, or both racks. The corresponding symbol lights the rack(s) you have selected. (DFUD142 only)</p>
 <p><b>Heavy</b> For heavily soiled items</p>	 <p><b>Normal Temp</b> Selects a normal or economy water temperature for the wash program. Indicator light glows when on the normal setting and remains off when on economy setting.</p>
 <p><b>Normal</b> For normally soiled loads, such as plates, glasses, bowls, and lightly soiled pans, use normal wash with normal temperature and normal drying. To save water and energy, use normal wash with economy temperature and economy drying.</p>	 <p><b>Delay</b> Lets you delay running the dishwasher for five hours. After making your selections, press Delay then press start and close the door. The dishwasher will start five hours later.</p>
 <p><b>Light China</b> For lightly soiled loads that are washed immediately after use. Fine china and crystal can be washed in this program by using low temperature setting.</p>	 <p><b>Normal Drying</b> Activates normal drying. Press once to activate. For economy drying, press again to deactivate normal drying.</p>
 <p><b>Quick</b> For very lightly soiled dishes.</p>	 <p><b>Express</b> Washing time is reduced and wash temperatures are lowered. (Not available for use with Quick Wash or Rinse/Hold cycles). (DFUD142 only)</p>
 <p><b>Rinse/Hold</b> To rinse dishes that you plan to wash later that day.</p>	
<p><b>Start Stop</b> After you have selected the wash cycle and options, press Start. The start symbol will flash. This merely means the machine is ready. Close the door securely to start the dishwasher.</p>	

## CHANGING A PROGRAM AFTER THE UNIT HAS STARTED

**WARNING:** Depending on cycles/options selected, the dishwasher operates at very high temperatures. If opening the door is required during a cycle, use extreme caution. Door should be opened just enough to stop the wash cycle. Once wash arms have stopped (wait at least 10 seconds), door can be opened. Use extreme caution since hot steam may be released when door is opened.

The dishwasher is programmed to stop operating if the door is opened during a cycle. If you want to change a program or option after starting the machine, open the door slightly to let the spray arms stop rotating and avoid getting sprayed with water. Press and hold START for three seconds to cancel the current selection then press the touchpad(s) for your desired selection. Press START again and close the door. The drain pump will run to remove any dirty water from the dishwasher before starting the newly selected cycle. Check to make sure there is still detergent in the detergent dispenser.

### WHEN THE WASH IS FINISHED:

The indicator lights will come on for the last wash program and options that you used. (NOTE: The unit will not retain the Rinse/Hold or Quick program.)

### cycle data -

### DFUD042 AND DFUD142

DESCRIPTION	WATER TEMP.	PRE-WASH	MAIN WASH	RINSE
Pots/Pans	140°F or 170°F (60°C or 75°C)	2	1	3
Heavy	130°F or 160°F (55°C or 70°C)	2	1	2
Normal	130°F or 150°F (55°C or 65°C)	1 or 2	1	2
Light/China	105°F or 120°F (40°C or 50°C)	—	1	2
Quick	85°F or 120°F (30°C) or 50°C)	—	1	2
Rinse/Hold		—	—	1

DESCRIPTION	NORMAL DRYING OPTION	Total Water Gal (L)	Total Wash Time - Minutes			
			Input Water 60°F (10°C)		Input Water 120°F (49°C)	
			A	B	A	B
Pots/Pans	yes	4.5	230	240	190	195
Heavy	yes	4.5	210	220	175	185
Normal	yes	4.5	130	150	110	135
Light/China	yes	2.4	110	115	85	90
Quick	yes	2.1	25	—	15	—
Rinse/Hold	yes	0.8	4	—	4	—

A. Using the lower water temperature setting.

B. Using the higher water temperature setting.

NOTE: Includes time for dry

Express option available for Pots/Pans, Heavy, Normal, and Light/China cycles on DFUD142 model only.

Reduces washing time and lowers temperature (not available on Quick wash or Rinse/Hold)

## SAFETY

### DOOR SWITCH

The machine is equipped with a door switch, breaking the current and interrupting the wash cycle if the door is opened while the machine is in operation.

### LEVEL CONTROL

Furthermore, the dishwasher is equipped with a level control (overflow), automatically starting the drain pump should the water level reach a level higher than normal. This level control functions only if the dishwasher is in operation.

## MAINTENANCE

The tank and inner door of the dishwasher is manufactured of stainless steel and kept clean in the course of normal use. From time to time, the fine mesh filter and the wash arms should be removed for cleaning. The machine may be cleaned after a period of inactivity by adding a tablespoon of citric acid crystals to a wash cycle.

### THE FINE FILTER

Particles collected in the fine filter are automatically flushed away during operation. If the screen of the fine filter is clogged by lime sediment or dirt, it must be cleaned. This cannot always be seen on top of the screen. Therefore, remove the filter periodically and check the underside. First, remove the coarse strainer. Next, unscrew the horizontal filter which is located in center of fine filter. Remove the filter and clean the underside. Replace the filter and screw horizontal filter back in place.

### THE COARSE STRAINER

Large food particles, which cannot pass through the drainage pump, are collected in the coarse strainer. Lift out and empty the coarse strainer when necessary. Don't forget to put it back again. It is normal for a small amount of water to remain in the coarse strainer area.

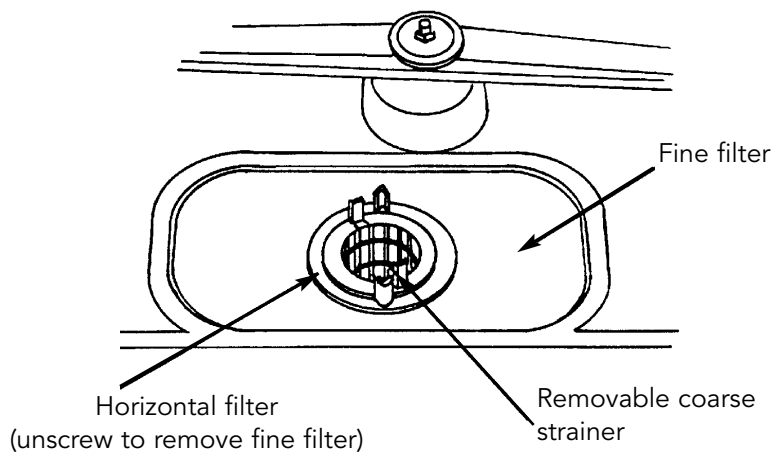

**WARNING:** Never operate the dishwasher without the filters in place.

### THE WASH ARM HOLES AND BEARINGS

The wash arm holes and bearings can be clogged by dirt. Remove the plastic locks on top of the flushing arms and lift them off. Use a needle or similar device to push the dirt out of the holes.

### AIR GAP

To prevent dirty water from siphoning back into the dishwasher, certain local plumbing codes demand that you install an air gap. This is not part of the dishwasher however, it is part of the plumbing. It is very important to keep the air gap clean. You should check it at least once a week to make sure that it is working as it should. If this is not the case, lift up the chrome cover and plastic cap, and clean with something suitable like a toothpick. Always check the air gap first if the drain becomes blocked and there is water left in the dishwasher.

## HOW TO CLEAN THE DRAIN PUMP

You can reach the drain pump from the inside of the machine. First remove the coarse strainer and the horizontal filter. Then, remove the small cover in the bottom left of the hole. There you can reach the pump wing and remove the dirt. Replace the cover, strainer and fine filter.

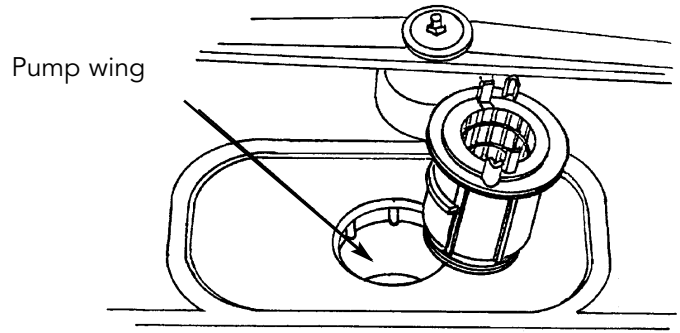

## HOW TO CLEAN THE DOOR

To clean the edge of the door, use only a soft damp cloth. Do not use any type of spray cleaner.

## WINTER STORING IN UNHEATED PLACES

If the dishwasher is kept in a place that is not heated, the draining and circulation as well as the inlet valve must be emptied of water. For further information, contact your dealer. Freezing ruptures are not covered by warranty.

## TROUBLESHOOTING

A simple fault may prevent the dishwasher from working. You may be able to remedy this yourself. Trace the fault with the help of the points listed below. Also, be sure to read "Poor Dishwashing Results" for more problems, possible causes, and suggested remedies.

### THERE IS WATER LEFT IN DISHWASHER

If the dishwasher is taking in too much water, the drainage pump starts automatically. If the water, in spite of this, is not drained off, it might depend on any of the following reasons:

**THE FILTER IS CLOGGED:** Lift out the coarse strainer and empty it. Place back in dishwasher before starting.

**THE PUMP IS BLOCKED:** Pieces of bone or other foreign particles might be stuck in the drainage pump. (See "How to Clean the Drain Pump").

### THE DRAIN HOSE IS CLOGGED (BLOCKED):

Check to make sure that there are not obstacles in the hose where it connects to the water. Foreign particles can get stuck in the entrance of the connection line. Also, check to make sure that the cone-shaped connection line has been cut to an inner diameter of at least 3/4" (1.9 cm).

### THE DRAIN HOSE IS KINKED:

Check to make sure that there are no folds or sharp bends in the drain hose.



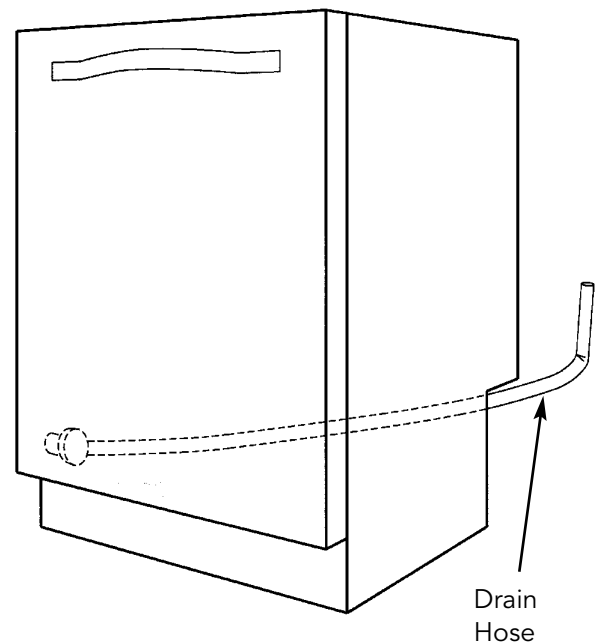

**AIR GAP:** If the machine is equipped with an air gap, see page 11. Be sure the air gap is not blocked or plugged.

### THE DISHWASHER DOES NOT START:

- Make sure the dishwasher is turned on and the door is closed securely.
- Make sure the DELAY option is not turned on.
- Check that the water supply is connected properly and the water is turned on.
- Make sure the power cord is properly plugged into the wall socket.
- Check your fuse box for a blown fuse or tripped circuit breaker.



## FAULT INDICATIONS

Display		Type of Fault	Action
	Flashes	Too much water in the dishwasher	Phone Service
	Flashes	Fault with water inlet	Check that the water tap is open
	Flashes	Valve leakage	Shut off the water tap and contact service
 	Flashes	Blocked drain	See "Possible Causes" in Troubleshooting Section on page 12.

To remove the fault indications from the display, turn off the main switch and then turn it back on again.

## POOR DISHWASHING RESULTS

Try the following remedies. Poor results may not always be caused by the dishwasher. Read through the chart below before contacting your servicer.

PROBLEM	POSSIBLE CAUSE	SUGGESTED REMEDY
Spotting and filming	Hard water	<p>Use the maximum recommended amount (3 tablespoons) of dishwasher detergent.</p> <p>To remove hard water spots, try a vinegar rinse:</p> <ul style="list-style-type: none"> <li>•Wash and rinse load as usual.</li> <li>•Remove all metal items from dishwasher.</li> <li>•Do not add detergent.</li> <li>•Pour two cups of vinegar into a bowl and set it on the bottom rack of the dishwasher.</li> <li>•Run the dishes through an entire wash program.</li> </ul> <p>If the vinegar rinse doesn't work, repeat the above process substituting 1/4 cup citric acid crystals (available at most drug stores) for the vinegar.</p> <p>Wiping with a damp cloth should remove spots from metal items. For sterling silver and silver plated flatware, rub with a towel, or use a good cream silver polish.</p>
	Filter system	Check filter system to be sure it is clean and properly installed.
	No rinse aid	Does the rinse aid dispenser need to be filled? (NOTE: Use only in hard water areas).
	Too little water	<p>Check that the water valve is fully opened. Make sure that the water pressure is between 18 and 176 psi.</p> <p>Check the filter inlet valve.</p>
	Dishwasher detergent	<p>Use only the correct amount of dishwasher detergent according to the hardness of the water and the wash program you have selected. Do not use old or caked detergent. Store the dishwasher detergent in a dry place and in a closed container.</p> <p>Change the dishwasher detergent if the result is still unsatisfactory.</p>
	Items not loaded properly	Check that you loaded the items according to the instructions on pages 5-6. Do not overload. Make sure water can reach all soiled surfaces.
	Wash arms rotate poorly or stand still	<p>Check that both wash arms can rotate freely and that items do not obstruct the movement of the wash arms. Lift the arms and make sure that no grains of dirt, etc., retard the rotation of the wash arms. If necessary, clear the obstruction, refit the arms and check that they rotate freely.</p> <p>Make sure that the holes in the wash arms are not blocked by dirt. If necessary, clear the holes with a pointed object.</p>
	Strainer blocked	Check the strainer. Clean if necessary. See page 11.
	Excessive foam in the machine	Use only dishwasher detergent.
	Flatware incorrectly loaded	Pay particular attention to spoons so that they do not nest in each other and prevent water penetration.

<b>PROBLEM</b>	<b>POSSIBLE CAUSE</b>	<b>SUGGESTED REMEDY</b>
Marks and discoloration	Aluminum utensils rubbing against items during washing	Be sure aluminum utensils, especially light weight foil-type pans, do not touch dishes. To remove spots, use a non-abrasive cleaner.
Small particles deposited on items	Wash arm or arms not rotating freely  Detergent  Low water pressure  Improper loading of dishes	Be sure a utensil or handle has not prevented their turning.  Use only fresh detergent, store in a tightly closed container in a cool dry place. Fill dispenser only when ready to start the dishwasher. Use the recommended amount of detergent, especially with hard water.  Check that the water valve is fully open. Make sure that the water pressure is between 18 and 176 psi.  Load dishes to prevent water and detergent from being trapped in or between items. Water should circulate freely.
Yellow or brown marks	Iron or manganese in water  Copper with sterling silver  Tea or coffee (tannic acid)	Temporary solution: Pour 1 teaspoon to 1 tablespoon of citric acid crystals in instead of the prewash detergent directly on the inside of the door. Follow this prewash with a full detergent wash. Use the pots/pans or normal wash cycle. Permanent solution: Install an iron removal system in the water supply.  Yellow film on sterling silver results when washing copper items in the same load. Silver polish usually removes the stain.  Tea or coffee can stain cups. Remove stains by hand, using a solution of 1/2 cup bleach and 3 cups warm water. (Do not use on sterling silver or silverplate.)
Discoloration of stainless steel, silverplate, or sterling silver	Allowing salty or acidic foods to remain on flatware  Stainless steel contacting silver	Rinse flatware that is to stand several hours before washing.  Do not put stainless steel and silver flatware in the same silverware basket compartment. Direct contact between these metals can cause permanent damage to silver. Clean stained items with silver polish. Do not use abrasives on stainless steel or silver.
Distortion of plastics	Plastic item has low heat tolerance	Plastics vary in their ability to tolerate heat. Check washing instructions for all plastic items to be sure they are dishwasher safe. If they are, place in upper rack away from the heating element.
Marks on melamine and plastics	Porous material	Use a special cleaner for plastic. <b>DO NOT</b> use bleach or scouring powder on these materials.
Detergent left in detergent compartment	Compartment cover blocked  Old detergent	The cover may not be opening because of improperly loaded items. Move dishes that may be blocking it.  If detergent is hard or caked in the box, throw away. Use only fresh detergent. Add detergent just before starting the dishwasher.

<b>PROBLEM</b>	<b>POSSIBLE CAUSE</b>	<b>SUGGESTED REMEDY</b>
Cloudy film on glassware-etching of glass	Too much detergent, especially in soft water	If vinegar or citric acid rinse doesn't remove film, the cloudiness is "etching". This is permanent. To prevent etching, use the least amount (one teaspoon) of recommended dishwasher detergent if you have soft water. Use a good quality of dishwashing detergent and rinse aid. Do not overload the machine. Water should circulate freely to assure adequate rinsing and draining. Use drying without heat.
Dishes not dry	Non-heat drying  No rinse aid  Plastic items  Improper loading or unloading  Dry cycle interrupted	Be sure to select heated drying for best results. Allow more drying time when using non-heat drying.  Fill rinse aid dispenser. Rinse aid helps dishes to dry faster. (See page 8) NOTE: Use rinse aid with hard water only.  Certain plastic materials are difficult to dry. Plastics may need towel drying.  Do not overload or nest items. Be sure all surfaces drain well. Load items with concave bases so as much water as possible can run off. Unload the lower rack first. Water from dishes in the upper rack may be spilling onto the lower rack.  If the door is opened during the heated dry cycle, the heating element comes back on after the door is closed. If the dishwasher door is opened immediately after the dry cycle is completed and then shut again, the vent door is closed, trapping warm humid air. It is best then to leave door open slightly.
Chipping or breaking of glassware	Improper loading	Do not overload. Load between prongs, not over them. Glasses loaded over prongs are not supported and may break. Make sure glassware is secure. Always use upper rack for delicate items. Use the light/china cycle.
Unusual noise	Improper loading	Utensils may not be secure or may have dropped from the rack. Water may cause utensils to rattle. Make sure everything is securely placed in dishwasher.
Dishwasher will not fill	Door open  Controls  Water feed line  Water supply	Check that door is firmly closed.  Check that dishwasher is on.  Check to see that the water feed line is not crimped.  Be sure water is available and turned on.
Dishwasher will not start.		Refer to page 12.
Dishwasher will not drain.		Refer to page 12.

<b>PROBLEM</b>	<b>POSSIBLE CAUSE</b>	<b>SUGGESTED REMEDY</b>
Water backs up in sink when dishwasher drains	Food waste disposer and trap	Check disposer and trap at sink for blockage or food particles.
Water left in bottom near filters	Dishwashing cycle not complete  Some is normal	Allow dishwasher to complete cycle.  Water left in removable coarse strainer is normal.
Bad odour in the machine	The low temperature programs have been selected over a longer period of time.	Run a program at Normal temperature about once per month.

## **SERVICE INFORMATION**

It is assumed that your dishwasher has been properly installed in accordance with all specifications and local codes and that the appliance has been properly grounded. If your dishwasher should fail to operate, check the troubleshooting section of this manual.

### **IF SERVICE IS REQUIRED:**

- Call your dealer or authorized service agency. The name of the authorized service agency can be obtained from the dealer or distributor in your area.
- Have the following information readily available:
  - a. Model number
  - b. Serial number
  - c. Date of purchase
  - d. Name of dealer from whom purchased.
- Clearly describe the problem you are experiencing.

If you are unable to obtain the name of an authorized service agency, or if you continue to have service problems, contact Viking at (888)845-4641 or write to:

**VIKING PREFERRED SERVICE**  
**111 Front Street**  
**Greenwood, Mississippi 38930 USA**

Record the following information indicated below. You will need it if service is ever required. The model and serial numbers are located on an identification label attached to the right side of the inner door. For access, simply open the door of the dishwasher.

MODEL NO. \_\_\_\_\_ SERIAL NO. \_\_\_\_\_  
 DATE OF PURCHASE \_\_\_\_\_ DATE INSTALLED \_\_\_\_\_  
 DEALER'S NAME \_\_\_\_\_  
 ADDRESS \_\_\_\_\_

If service requires installation of parts, use only authorized parts to insure protection under the warranty.

**THIS MANUAL SHOULD REMAIN WITH THE DISHWASHER FOR FUTURE REFERENCE.**

**DESIGNER SERIES**  
**UNDERCOUNTER DISHWASHER WARRANTY**  
**ONE YEAR FULL WARRANTY**

Undercounter dishwashers and all of their component parts, except as detailed below\*, are warranted to be free from defective materials or workmanship in normal household use for a period of twelve (12) months from the date of original retail purchase. Viking Range Corporation, warrantor, agrees to repair or replace, at its option, any part which fails or is found to be defective during the warranty period.

\*Painted and decorative items are warranted to be free from defective materials or workmanship for a period of ninety (90) days from the date of original retail purchase. ANY DEFECTS MUST BE REPORTED TO THE SELLING DEALER WITHIN NINETY (90) DAYS FROM DATE OF ORIGINAL RETAIL PURCHASE.

**FIVE YEAR LIMITED WARRANTY**

Any upper and/or lower nylon rack which rusts due to defective materials or workmanship in normal household use during the second through fifth year from the date of original retail purchase will be repaired or replaced, free of charge for the part itself, with the owner paying all other costs, including labor.

Any motor/pump assembly or water distribution system component as listed below which fails due to defective materials or workmanship in normal household use during the second through fifth year from the date of original retail purchase will be repaired or replaced, free of charge for the part itself, with the owner paying all other costs, including labor.

**Motor/Pump and Water Distribution System Components**

Circulation motor/pump	Lower wash arm	Fill valve
Drain motor/pump	Tube to upper wash arm	Upper wash arm

**TWENTY-FIVE YEAR LIMITED WARRANTY**

Any stainless steel tank or inner door liner which develops a water leak due to defective materials or workmanship in normal household use during the second through the twenty-fifth year from the date of original retail purchase will be repaired or replaced, free of charge for the part itself, with the owner paying all other costs, including labor.

**NINETY (90) DAY RESIDENTIAL PLUS WARRANTY** This warranty applies to applications where use of the product extends beyond normal residential use. Examples are, but not limited to, bed and breakfasts, fire stations, private clubs, churches, etc. This warranty excludes all commercial locations such as restaurants, food service locations and institutional food service locations.

This warranty extends to the original purchaser of the product warranted hereunder and to each transferee owner of the product during the term of the warranty.

This warranty shall apply to products purchased and located in the United States and Canada. Products must be purchased in the country where service is requested. Warranty labor shall be performed by an authorized Viking Range Corporation service agency or representative. Warranty shall not apply to damage resulting from abuse, accident, natural disaster, loss of electrical power to the product for any reason, alteration, outdoor use, improper installation, improper operation, or repair or service of the product by anyone other than an authorized Viking Range Corporation service agency or representative. This warranty does not apply to commercial usage. Warrantor is not responsible for consequential or incidental damage whether arising out of breach of warranty, breach of contract, or otherwise. Some jurisdictions do not allow the exclusion or limitation of incidental or consequential damages, so the above limitation or exclusion may not apply to you.

Owner shall be responsible for proper installation, providing normal care and maintenance, providing proof of purchase upon request, and making the appliance reasonably accessible for service. If the product or one of its component parts contains a defect or malfunction during the warranty period, after a reasonable number of attempts by the warrantor to remedy the defects or malfunctions, the owner is entitled to either a refund or replacement of the product or its component part or parts. Warrantor's liability on any claim of any kind, with respect to the goods or services covered hereunder, shall in no case exceed the price of the goods or service or part thereof which gives rise to the claim.

**WARRANTY SERVICE:** Under the terms of this warranty, service must be performed by a factory authorized Viking Range Corporation service agent or representative. Service will be provided during normal business hours, and labor performed at overtime or premium rates shall not be covered by this warranty. To obtain warranty service, contact the dealer from whom the serial number and date of original purchase. For the name of your nearest authorized Viking Range Corporation service agency, call the dealer from whom the product was purchased or Viking Range Corporation. **IMPORTANT:** Retain proof of original purchase to establish warranty period.

The return of the Owner Registration Card is not a condition of warranty coverage. You should, however, return the Owner Registration Card so that Viking Range Corporation can contact you should any question of safety arise which could affect you.

Any implied warranties of merchantability and fitness applicable to the above described nylon racks, motor/pump assembly, water distribution system, stainless steel tank, or stainless steel inner door liner are limited in duration to the period of coverage of the applicable express written limited warranties set forth above. Some jurisdictions do not allow limitations on how long an implied warranty lasts, so the above limitation may not apply to you. This warranty gives you specific legal rights, and you may also have other rights which may vary from jurisdiction to jurisdiction.

Specification subject to change without notice.



Viking Range Corporation

111 Front Street

Greenwood, Mississippi 38930 USA

(662) 455-1200

For product information,

call 1-888-VIKING1 (845-4641)

or visit the Viking Web site at

[vikingrange.com](http://vikingrange.com)