

# omega

## Ceramic Cooktop

Instruction Manual / Installation Manual

**Model: OCC90TZ**

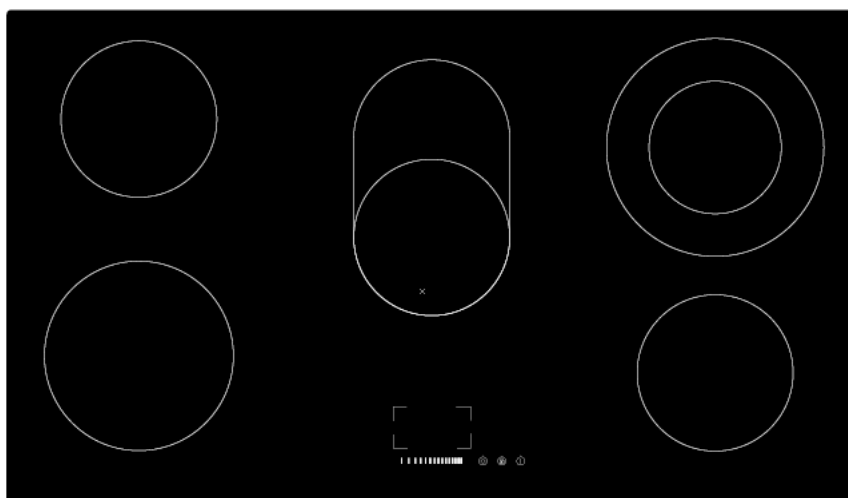

*Congratulations*

*Enjoy your new ceramic cooktop*

Thank you for introducing our family to yours

At Omega, we understand that cooking, cleaning and washing may not be your favourite things in the world. That's why we created a range of no-nonsense, reliable products that always get the job done for you. With the features you need and nothing you don't. What's more, they're made to fit perfectly into your home life and your wallet. You are welcoming an Omega appliance into your place and you can be sure it'll always serve you well.

We aim to simplify any further appliance purchases. When researching our products you will find a range of icons that visually represent our products key features. Visit our website to learn more about these icons and the features and benefits of our products.

For important information such as instruction manuals, specifications and catalogues, please visit [omegaappliances.com.au/customer](http://omegaappliances.com.au/customer) (for Australia) or [omegaappliances.co.nz/customer](http://omegaappliances.co.nz/customer) (for New Zealand). Also, make sure you activate your product warranty by registering your warranty online using the links above.

We value your opinion, so please take a few minutes to tell us what you think about your new addition! Simply go to the relevant appliance page of our website [omegaappliances.com.au](http://omegaappliances.com.au) and click on "Write a Review".

If you want to know more about promotions, receive cool tips and tailor made content or just connect with us on social media, like [omegaappliances](#) on Facebook and follow [omegaappliances\\_au](#) on Instagram.

Enjoy your new appliance and remember, we're only one click away!



**[omegaappliances.com.au](http://omegaappliances.com.au) / [omegaappliances.co.nz](http://omegaappliances.co.nz)**



**[omegaappliances](#)**



**[omegaappliances\\_au](#)**

## Content

SECTION	PAGES
FORWARD	03-06
PRODUCT INTRODUCTION	07-08
OPERATION OF PRODUCT	08-13
COOKING GUIDELINES	14
HEAT SETTINGS	14
CARE & CLEANING	15
HINTS & TIPS	16
INSTALLATION	16-18
WARRANTY	19

## **1. Foreword**

### **1.1 Safety Warnings**

Your safety is important to us. Please read this information before using your cooktop.

### **1.2 Installation**

#### **1.2.1 Electrical Shock Hazard**

- Disconnect the appliance from the mains electricity supply before carrying out any cleaning or maintenance on it.
- Connection to a good earth wiring system is essential and mandatory.
- Alterations to the domestic wiring system must only be made by a qualified electrician.
- Failure to follow this advice may result in electrical shock or death.

#### **1.2.2 Cut Hazard**

- Take care - panel edges are sharp.
- Failure to use caution could result in injury or cuts.

#### **1.2.3 Important safety instructions**

- Read these instructions carefully before installing or using this appliance.
- No combustible material or products should be placed on this appliance at any time.
- Please make this information available to the person responsible for installing the appliance as it could reduce your installation costs.
- In order to avoid a hazard, this appliance must be installed according to these instructions for installation.
- This appliance is to be properly installed and earthed only by a suitably qualified person.
- CAUTION-The cooking process has to be supervised. A short term cooking process has to be supervised continuously.

- This appliance should be connected to a circuit which incorporates an isolating switch providing full disconnection from the power supply.
- Failure to install the appliance correctly could invalidate any warranty or liability claims.

### **1.3 Operation and maintenance**

#### **1.3.1 Electrical Shock Hazard**

- Do not cook on a broken or cracked cooktop. If the cooktop surface should break or crack, switch the appliance off immediately at the mains power supply (wall switch) and contact a qualified technician.
- Failure to follow this advice may result in electrical shock or death.

#### **1.3.2 Health Hazard**

- This appliance complies with electromagnetic safety standards.
- However, persons with cardiac pacemakers or other electrical implants (such as insulin pumps) must consult with their doctor or implant manufacturer before using this appliance to make sure that their implants will not be affected by the electromagnetic field.
- Failure to follow this advice may result in death.

#### **1.3.3 Hot Surface Hazard**

- During use, accessible parts of this appliance will become hot enough to cause burns.
- Do not let your body, clothing or any item other than suitable cookware contact the Ceramic glass until the surface is cool.
- Metallic objects such as knives, forks, spoons and lids should not be placed on the hob surface since they can get hot
- Keep children away.
- Handles of saucepans may be hot to touch. Check saucepan handles do not overhang other cooking zones that are on. Keep handles out of reach of children.
- Failure to follow this advice could result in burns and scalds.
- Magnetisable metal objects worn on the body can become hot in the vicinity of the appliance (materials like gold are not affected).

#### **1.3.4 Cut Hazard**

- The razor-sharp blade of a cooktop scraper is exposed when the safety cover is retracted. Use with extreme care and always store safely and out of reach of children.
- Failure to use caution could result in injury or cuts.

#### **1.3.5 Important safety instructions**

- Never leave the appliance unattended when in use. Boilover causes smoking and greasy spillovers that may ignite.
- Never use your appliance as a work or storage surface.
- Never use your appliance for warming or heating the room.
- After use, always turn off the cooking zones and the cooktop as described in this manual (i.e. by using the touch controls). Do not allow children to play with the appliance or sit, stand, or climb on it.
- Handles of cooking utensils may be hot to touch. Check that handles do not hang over other cooking zones that are active. Keep handles out of reach of children. Failure to follow this advice can result in scalding.
- Do not store items of interest to children in cabinets above the appliance. Children climbing on the cooktop could be seriously injured.
- This appliance is not intended for use by persons (including children) with reduced physical, sensory or mental capabilities, or lack of experience or knowledge, unless they have been given supervision or instruction concerning the use of the appliance by a person responsible for their safety. Children should be supervised to ensure that they do not play with the appliance.
- Do not repair or replace any part of the appliance unless specifically recommended in the manual. All other servicing should be done by a qualified technician.
- Do not use a steam cleaner to clean your cooktop.
- Do not place or drop heavy objects on your cooktop.
- Do not stand on your cooktop.
- Do not use pans with jagged edges or drag pans across the Ceramic glass surface as this can scratch the glass.
- Do not use scourers or any other harsh abrasive cleaning agents to clean your cooktop, as these can scratch the Ceramic glass.

- If the supply cord is damaged, it must be replaced by the manufacturer, its service agent or similarly qualified persons in order to avoid a hazard.
- This appliance is intended to be used in household and similar applications such as: -staff kitchen areas in shops, offices and other working environments; -farm houses; -by clients in hotels, motels and other residential type environments; -bed and breakfast type environments.
- **WARNING:** The appliance and its accessible parts become hot during use.
- Care should be taken to avoid touching heating elements.
- Cleaning and user maintenance shall not be made by children without supervision.
- **WARNING:** Unattended cooking on a hob with fat or oil can be dangerous and may result in fire. NEVER try to extinguish a fire with water, but switch off the appliance and then cover flame e.g. with a lid or a fire blanket.
- **WARNING:** Danger of fire: Do not store items on the cooking surfaces.
- **Warning:** If the surface is cracked, switch off the appliance to avoid the possibility of electric shock.
- The appliance is not intended to be operated by means of an external timer or separate remote-control system.

## 2. Product Introduction

### 2.1 Top View

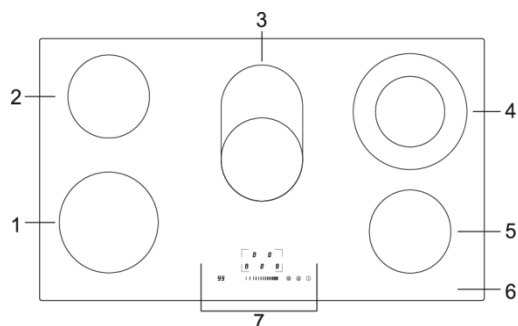

1. Max. 1800 W zone
2. Max. 1200 W zone
3. Max. 1100/ 2000W dual zone
4. Max. 1000/ 2200W dual zone
5. Max. 1200 W zone
6. Glass plate
7. Control panel

### 2.2 Control Panel

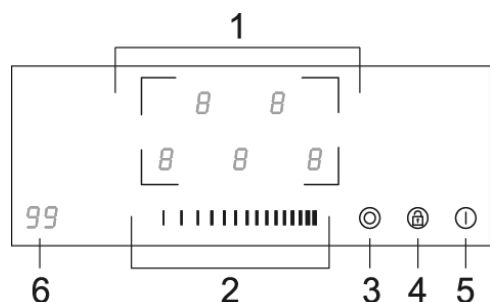

1. Heating zone selection controls
2. Power/Timer slider touch control
3. Dual zone control
4. Keylock control
5. ON/OFF control
6. Timer display

### 2.3 Product Information

The ceramic cooktop can meet different kinds of cuisine demands because of resistance wire heating, micro-computerised controls and multi-power selection; really the optimal choice for modern families. The cooktop centres on customers and adopts a personalised design. The cooktop has safe and reliable performances, making your life comfortable and enabling to fully enjoy the pleasure from life.

### 2.4 Before using your New Ceramic Hob

- Read this guide, taking special note of the 'Safety Warnings' section.
- Remove any protective film that may still be on your ceramic hob.

## 2.5 Technical Specification

Cooking Hob	OCC90TZ
Cooking Zones	5 Zones
Supply Voltage	220-240V~ 50Hz/60Hz
Installed Electric Power	7600-9200W
Product Size L×W×H(mm)	900x520x55
Building-in Dimensions A×B (mm)	875x495

Weight and Dimensions are approximate. Because we continually strive to improve our products we may change specifications and designs without prior notice.

## 3. Operation of Product

### 3.1 Touch Controls

- The controls respond to touch, so you don't need to apply any pressure.
- Use the ball of your finger, not its tip.
- You will hear a beep each time a touch is registered.
- Make sure the controls are always clean, dry, and that there is no object (e.g. a utensil or a cloth) covering them. Even a thin film of water may make the controls difficult to operate.

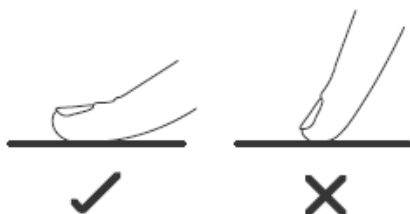

### 3.2 Choosing the right Cookware

Do not use cookware with jagged edges or a curved base.



Make sure that the base of your pan is smooth, sits flat against the glass, and is the same size as the cooking zone. Always centre your pan on the cooking zone.

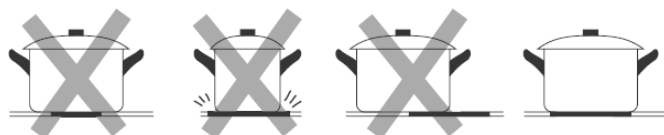

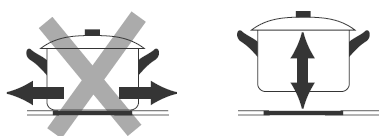

Always lift pans off the ceramic hob – do not slide, or they may scratch the glass.



### 3.3 How to use

#### 3.3.1 Start cooking

After power on, the buzzer beeps once, all the indicators light up for 1 second then go out, indicating that the ceramic hob has entered the standby mode.

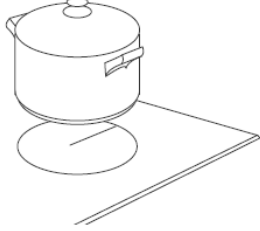
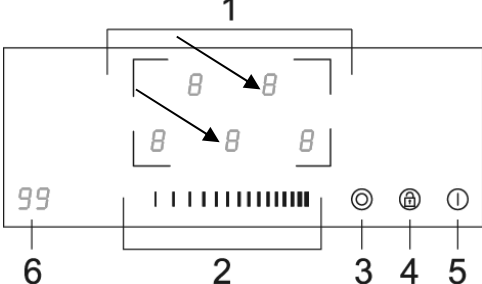
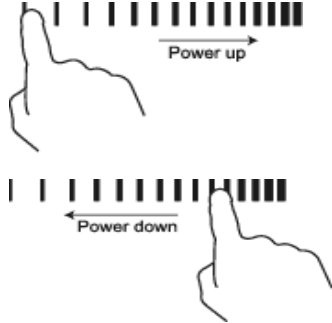
<p>Touch the ON/OFF  control. All the indicators show "--"</p>	
<p>Place a suitable pan on the cooking zone that you wish to use.</p> <ul style="list-style-type: none"><li>• Make sure the bottom of the pan and the surface of the cooking zones are clean and dry.</li></ul>	
<p>Touching the heating zone selection control, and an indicator next to the key will flash</p>	
<p>Adjust heat setting by touching the slider control.</p> <ul style="list-style-type: none"><li>• If you don't choose a heat setting within 1 minute, the ceramic hob will automatically switch off. You will need to start again at step 1.</li><li>• You can modify the heat setting at any time during cooking.</li><li>• You can modify the power level from 0 to 9 by the slide control.</li></ul>	

### 3.3.2 Finish cooking

Touching the heating zone selection control that you wish to switch off.

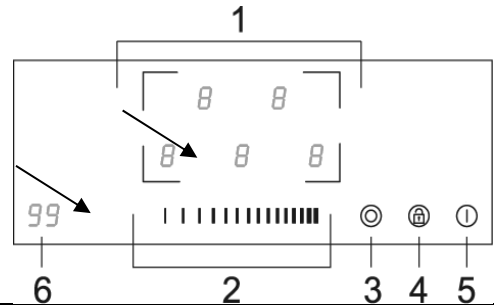

Turn the cooking zone off by touching the slider to the lowest point.  
Make sure the display shows "0". After cooking an **H** symbol will appear to indicate the surface is still hot and will go out when the surface is cooler.

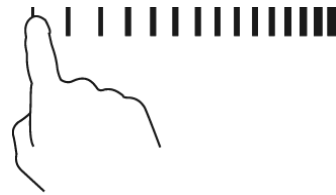

Turn the whole cooktop off by touching the ON/OFF  control.





#### Beware of hot surfaces



"H" will show which cooking zone is too hot to touch. It will disappear when the surface has cooled down to a safe temperature. It can also be used as an energy saving function if you want to heat further pans, use the hotplate that is still hot.



### 3.3.3 Locking the Controls

- You can lock the controls to prevent unintended use (for example children accidentally turning the cooking zones on).
- When the controls are locked, all the controls except the ON/OFF control are disabled.

To lock the controls	
Touch the lock  control	The timer indicator will show "Lo "
To unlock the controls	
Make sure the ceramic hob is turned on Touch and hold the lock control  for a while.	

 When the hob is in the lock mode, all the controls are disabled except the ON/OFF , you can always turn the ceramic hob off with the ON/OFF  control in an emergency, but you must unlock the hob first in the next operation.

### 3.3.4 Using the dual zone function

- This function only works on zones 3# and 4#.
- The dual cooking zone has two cooking areas that you can use a central section and an outer section. You can use the central section **(A)** independently or both sections **(B)** at once.

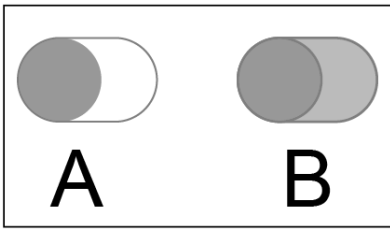

Zone 3#

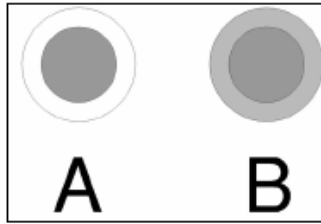

Zone 4#

<b>Activate the Dual zone</b>	
Press the heating zone selection and then the dual zone control to activate the dual area (e.g. 6,)	
The power level indicator will flash, then press "⊙", after 5 seconds, the indicator stop flash, the dual zone function is activated, and power level shows "6" and "=" alternately.	
<b>Deactivate the Dual zone</b>	
Press the heating zone selection control of the dual zone, the power level indicator will flash.	
Press "⊙", and the dual heat zone will be cancelled and power level returned to "6".	

Note:

1. The dual zone function is available only in 3# and 4# cooking zones
2. You can select the function from level 1 to level 9.





### 3.3.5 Timer control

You can use the timer in two different ways:

- a) You can use it as a minute minder. **In this case, the timer will not turn any cooking zone off when the set time is up.**
- b) You can set it to turn a cooking zone off after the set time is up.  
The timer is a maximum of 99 minutes.

## a) Using the Timer as a Minute Minder



If you are not selecting any cooking zone



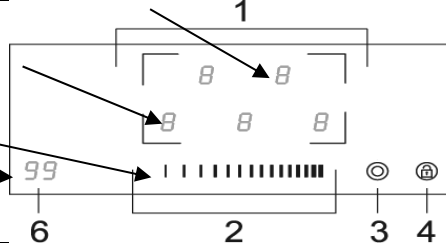

<p>Make sure the cooktop is turned on.          Note: you can use the minute minder even if you're not selecting any cooking zone.          Touch the timer control, the "10" will show in the timer display and the "0" flashes</p>	
<p>Set the time by touching the slider control. (e.g. 5)</p>	
<p><b>Touch timer control again, the "1" will flash. To set a time less than 10 minutes you will need to set the right number first and then the left number to "0"</b></p>	
<p>Set the time by touching the slider control (e.g.9), now the timer you set is 95 minutes.          When the time is set, it will begin to count down immediately.          The display will show the remaining time</p>	
<p>Buzzer will beep for 30 seconds and the timer indicator shows "- -" when the setting time finished.</p>	

Hint:

- a) Touch the "-" or "+" control of the timer once to decrease or increase by 1 minute.
- b) Touch and hold the "-" or "+" control of the timer to decrease or increase by 10 minutes.
- c) If the setting time exceeds 99 minutes, the timer will automatically return to 0 minute.

## b) Setting the timer to turn one cooking zone off

Set one zone	
<p>*Touching the heating zone selection control that you want to set the timer for.          INCREASE OR DECREASE TEMPERATURE OR TIME</p> <p style="text-align: center;">TIMER CONTROL/DISPLAY</p>	
<p>Touch timer control , the "10" will show in the timer display and the "0" flashes.</p>	

Set the time by touching the slider control. (e.g. 5)	
<b>Touch timer control again, the "1" will flash. To set a time less than 10 minutes you will need to set the right number first and then the left number to "0"</b>	
Set the time by touching the slider control (e.g.9), now the timer you set is 95 minutes.	
When the time is set, it will begin to count down immediately. The display will show the remaining time When cooking timer expires, the corresponding cooking zone will be switched off automatically.	

Note:

- a) The red dot next to power level indicator will illuminate indicating that zone is selected.



- b) You want to change the time after the timer is set, you have to start from step 1.

### 3.3.6 Over-Temperature Protection

A temperature sensor equipped can monitor the temperature inside the ceramic hob. When an excessive temperature is monitored, the ceramic hob will stop operation automatically.

### 3.3.7 Residual Heat Warning

When the hob has been operating for some time, there will be some residual heat. The letter " H "appears to warn you to keep away from it.

### 3.3.8 Default working times

Another safety feature of the hob is automatic shutdown. This occurs whenever you forget to switch off a cooking zone. The default shutdown times are shown in the table below:

Power level	1	2	3	4	5	6	7	8	9
Default working timer (hour)	8	8	8	4	4	4	2	2	2

## 4. Cooking Guidelines



Take care when frying as the oil and fat heat up very quickly. At extremely high temperatures oil and fat will ignite spontaneously and this presents a serious fire risk.

## 4.1 Cooking Tips

- When food comes to the boil, reduce the power setting as needed to maintain a steady boil.
- Using a lid will reduce cooking times on some dishes and save energy by retaining the heat.

### 4.1.1 Simmering, cooking rice

- Simmering occurs below boiling point, at around 85°C, when bubbles are just rising occasionally to the surface of the cooking liquid. It is the key to delicious soups and tender stews because the flavours develop without overcooking the food.

### 4.1.2 Searing steak

To cook juicy flavoursome steaks:

1. Stand the meat at room temperature for about 20 minutes before cooking.
2. Heat up a heavy-based frying pan.
3. Brush both sides of the steak with oil.
4. Turn the steak as required during cooking. The exact cooking time will depend on the thickness of the steak and how cooked you want it. Times may vary from about 2 – 8 minutes per side. Press the steak to gauge how cooked it is – the firmer it feels the more 'well done' it will be.
5. Leave the steak to rest on a warm plate for a few minutes to allow it to relax and become tender before serving.

### 4.1.3 For stir-frying

1. Choose a ceramic compatible flat-based wok or a large frying pan.
2. Have all the ingredients and equipment ready. Stir-frying should be quick. If cooking large quantities, cook the food in several smaller batches.
3. Preheat the pan and add oil.
4. Cook any meat first, put it aside and keep warm.
5. Stir-fry the vegetables. When they are hot but still crisp return the meat to the pan and add your sauce.
6. Stir the ingredients gently to make sure they are heated through.
7. Serve immediately.

## 5. Heat Settings

The settings below are guidelines only. The exact setting will depend on several factors, including your cookware and the amount you are cooking. Experiment with the Ceramic hob to find the settings that best suit you.

Heat setting	Suitability
1 - 2	<ul style="list-style-type: none"><li>• delicate warming for small amounts of food</li><li>• melting butter, and foods that burn quickly</li><li>• gentle simmering</li><li>• slow warming</li></ul>
3 - 4	<ul style="list-style-type: none"><li>• reheating</li><li>• rapid simmering</li><li>• cooking rice</li></ul>
5 - 6	<ul style="list-style-type: none"><li>• pancakes</li></ul>
7 - 8	<ul style="list-style-type: none"><li>• sautéing</li><li>• cooking pasta</li></ul>
9	<ul style="list-style-type: none"><li>• stir-frying</li><li>• searing</li><li>• bringing soup to the boil</li><li>• boiling water</li></ul>

## 6. Care and Cleaning

What?	How?	Important!
Everyday soiling on glass (fingerprints, marks, stains left by food or non-sugary spillovers on the glass)	<ol style="list-style-type: none"> <li>1. Make sure the cooktop is off.</li> <li>2. Apply a cooktop cleaner while the glass is cool.</li> <li>3. Rinse and wipe dry with a clean cloth or paper towel.</li> <li>4. Switch the power to the cooktop back on.</li> </ol>	<ul style="list-style-type: none"> <li>• When the power to the cooktop is switched off, there will be no 'hot surface' indication but the cooking zone may still be hot! Take extreme care.</li> <li>• Heavy-duty scourers, some nylon scourers and harsh/abrasive cleaning agents may scratch the glass. Always read the label to check if your cleaner or scourer is suitable.</li> <li>• Never leave cleaning residue on the cooktop: the glass may become stained.</li> </ul>
Boilovers, melts, and hot sugary spills on the glass	<p>Remove these immediately with a fish slice, palette knife or razor blade scraper suitable for Ceramic glass cooktops, but beware of hot cooking zone surfaces:</p> <ol style="list-style-type: none"> <li>1. Switch the power to the cooktop off at the wall.</li> <li>2. Hold the blade or utensil at a 30° angle and scrape the soiling or spill to a cool area of the cooktop.</li> <li>3. Clean the soiling or spill up with a dish cloth or paper towel.</li> <li>4. Follow steps 2 to 4 for 'Everyday soiling on glass' above.</li> </ol>	<ul style="list-style-type: none"> <li>• Remove stains left by melts and sugary food or spillovers as soon as possible. If left to cool on the glass, they may be difficult to remove or even permanently damage the glass surface.</li> <li>• Cut hazard: when the safety cover is retracted, the blade in a scraper is razor-sharp. Use with extreme care and always store safely and out of reach of children.</li> </ul>
Spillovers on the touch controls	<ol style="list-style-type: none"> <li>1. Switch the power to the cooktop off.</li> <li>2. Soak up the spill</li> <li>3. Wipe the touch control area with a clean damp sponge or cloth.</li> <li>4. Wipe the area completely dry with a paper towel.</li> <li>5. Switch the power to the cooktop back on.</li> </ol>	<ul style="list-style-type: none"> <li>• The cooktop may beep and turn itself off, and the touch controls may not function while there is liquid on them. Make sure you wipe the touch control area dry before turning the cooktop back on.</li> </ul>

## 7. Hints and Tips

Problem	Possible causes	What to do
The cooktop cannot be turned on.	No power.	Make sure the ceramic hob is connected to the power supply and that it is switched on. Check whether there is a power outage in your home or area. If you've checked everything and the problem persists, call a qualified technician.
The touch controls are unresponsive.	The controls are locked.	Unlock the controls. See section 'Using your ceramic cooktop' for instructions.
The touch controls are difficult to operate.	There may be a slight film of water over the controls or you may be using the tip of your finger when touching the controls.	Make sure the touch control area is dry and use the ball of your finger when touching the controls.
The glass is being scratched.	Rough-edged cookware.  Unsuitable, abrasive scourer or cleaning products being used.	Use cookware with flat and smooth bases. See 'Choosing the right cookware'.  See 'Care and cleaning'.
Some pans make crackling or clicking noises.	This may be caused by the construction of your cookware (layers of different metals vibrating differently).	This is normal for cookware and does not indicate a fault.

## 8. Installation

### 8.1 Selection of installation equipment

Cut out the work surface according to the sizes shown in the drawing. A 3mm minimum gap should be left between the side of the appliance and the cupboard edges.

Be sure the thickness of the work surface is at least 30mm. Please select heat-resistant work surface material to avoid any deformation caused by the heat radiating from the hotplate. As shown below:

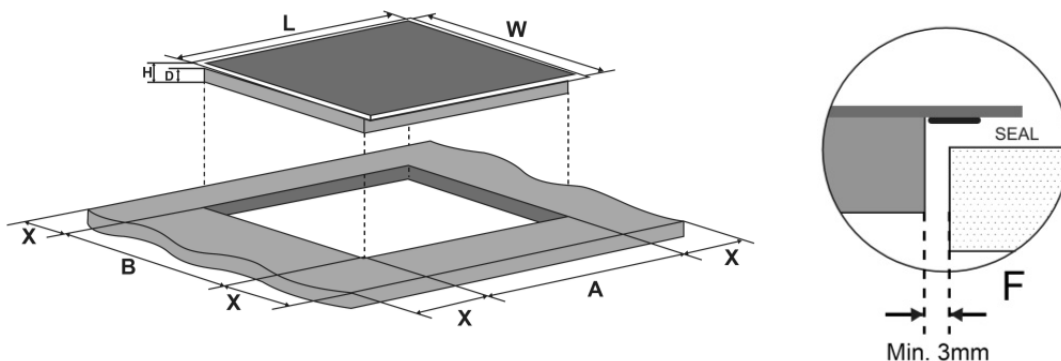

L(mm)	W(mm)	H(mm)	D(mm)	A(mm)	B(mm)	X(mm)	F(mm)
900	520	55	51	875+4 +1	495+4 +1	50 mini	3 mini

Under any circumstances, make sure the ceramic cooker hob is well ventilated and the air inlet and outlet are not blocked. Follow the following dimensions:



Note: The safety distance between the cooktop and the cupboard above the cooktop should be at least 700mm, and between the cooktop and rangehood must be a minimum of 650mm.

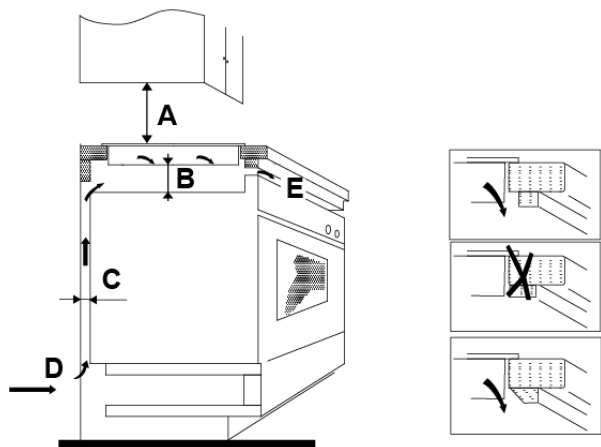

A(mm)	B(mm)	C(mm)	D	E
650mm	50 mini	20 mini	Air intake	Air exit 5mm

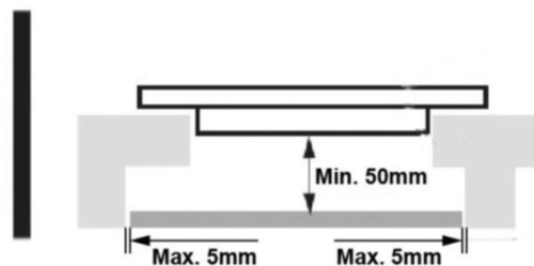

### WARNING: Ensuring Adequate Ventilation

Make sure the cooktop is well ventilated and that the air inlet & outlet are not blocked. To avoid accidentally touching the hot lower panel, it is necessary to install a wooden panel (fixed with screws) below the appliance at a minimum distance of 50mm. Cabinets surrounding the appliance must be able to withstand temperatures up to 150°C.

## 8.2 Before locating the fixing brackets

The unit should be placed on a stable, smooth surface (use the packaging). Do not apply force onto the controls protruding from the hob.

Fix the hob on the work surface by screw four brackets on the bottom of hob (see picture) after installation.

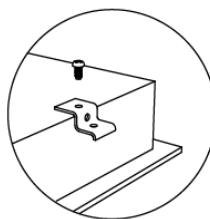
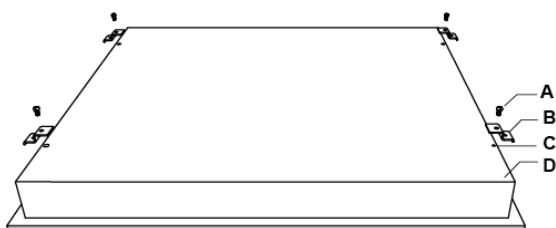

A	B	C	D
screw	bracket	Screw hole	base

Adjust the bracket position to suit for different work surface's thickness.

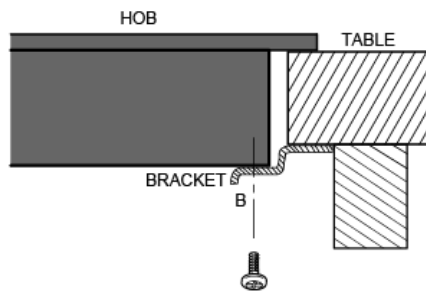
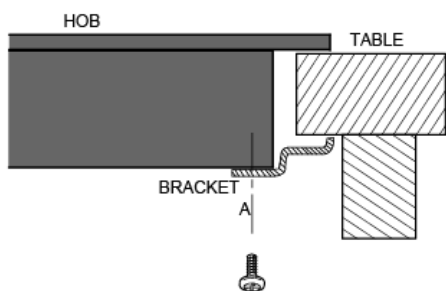

## 8.3 Cautions

1. The ceramic cooker hob must be installed by qualified personnel or technicians. We have professionals at your service. Please never conduct the operation by yourself.
2. The ceramic cooker hob shall not be mounted to cooling equipment, dishwashers and rotary dryers.
3. The ceramic cooker hob shall be installed such that better heat radiation can be ensured to enhance its reliability.
4. The wall and induced heating zone above the work surface shall withstand heat.
5. To avoid any damage, the sandwich layer and adhesive must be resistant to heat.
6. A steam cleaner is not to be used.

## 8.4 Connecting the hob to the mains power supply

The power supply should be connected in compliance with the relevant standard, or a single-pole circuit breaker. The method of connection is shown below.

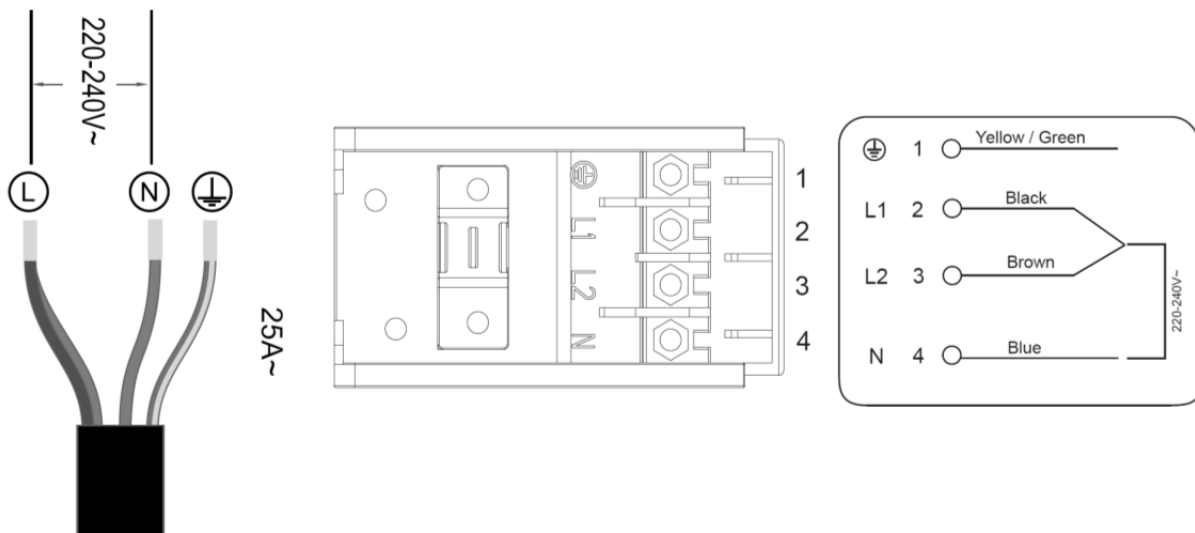
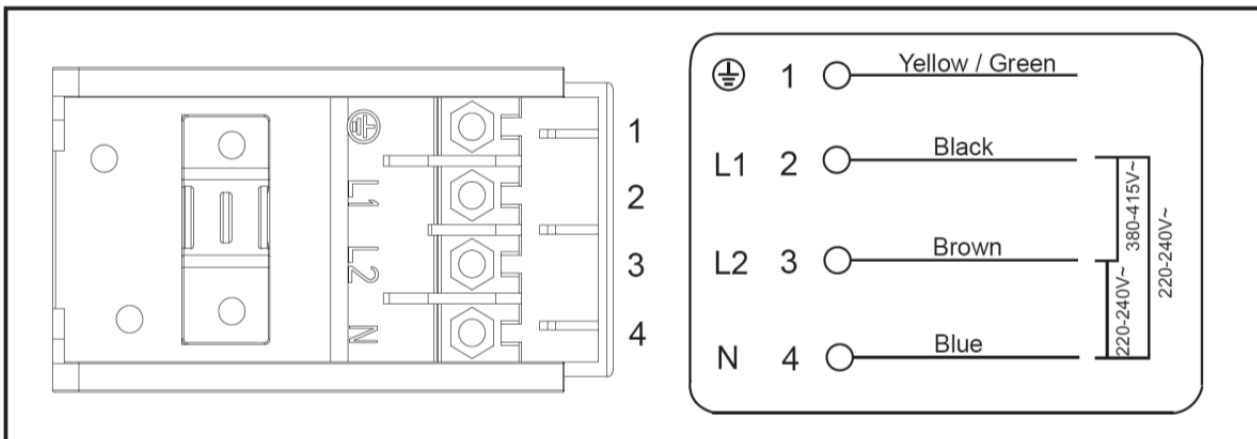

1. If the cable is damaged or needs replacing, this should be done by an after-sales technician using the proper tools, so as to avoid any accidents.
2. If the appliance is being connected directly to the mains supply, an all-pole circuit breaker must be installed with a minimum gap of 3mm between the contacts.
3. The installer must ensure that the correct electrical connection has been made and that it complies with safety regulations.
4. The cable must not be bent or compressed.
5. The cable must be checked regularly and only replaced by a properly qualified person.
6. The installer must use the H05GG-F power cord.

**AUSTRALIAN CUSTOMERS**

Our goods come with guarantees that cannot be excluded under the Australian Consumer Law. You are entitled to a replacement or refund for a major failure and for compensation for any other reasonably foreseeable loss or damage. You are also entitled to have the goods repaired or replaced if the goods fail to be of acceptable quality and the failure does not amount to a major failure.

**NEW ZEALAND CUSTOMERS**

Nothing herein contained shall be construed in any way as excluding or limiting your rights under the Consumer Guarantee Act 1993.

**OUR WARRANTY**

This product is also covered by the manufacturer's warranty set out in this document (Our Warranty).

Our Warranty is for a period of twenty four (24) months from the date of purchase and for refrigeration appliances will have an additional thirty six (36) months after the first twenty four (24) months on the Sealed System (PARTS only) Compressor & condenser etc. The labour cost to replace these parts is the responsibility of the customer.

This is in addition to (and does not exclude, restrict or modify) any rights or remedies to which you may already be entitled to under the Australian consumer law or the New Zealand Consumer Guarantee act 1993 relating to this product.

Our warranty (which is subject to the conditions below) covers rectification free of charge of any fault arising from defective materials or components, or faulty workmanship. The product will be repaired or replaced at the option of Omega, and all costs of installation, removal, cartage, freight travelling and insurance are to be paid by the customer.

Our warranty is subject to the following conditions:

1. That the purchaser contact Omega prior to any product repair.
2. That the purchaser carefully follows all instructions provided with the product and complies with all relevant electrical & plumbing regulations in their State when installing the product.
3. That the purchaser carefully follows the instructions provided in the owner's handbook relating to the proper use and care of the product and does not use the product for any purpose other than the DOMESTIC use for which it has been designed. If the appliance is used in commercial applications or for rental purposes, Our Warranty is limited to a warranty of Twelve (12) months covering all parts with Three (3) months on any labour cost of service or repair.

**SERVICE AREA**

The provision of service under Our Warranty is limited by the boundary / territory area of the nearest service centre. Travelling cost incurred for service outside this area is not covered by Our Warranty and service will incur commercial cost to be paid by the customer regulated by the number of kilometres travelled beyond the service area. These costs will be disclosed to you for acceptance by you prior to your claim being processed.

Microwave ovens must be returned to your nearest Authorised Service Centre for repair as they are a carry in serviceable appliance.

**WHAT IS COVERED: By Our Warranty**

During the warranty period, Omega or its authorised Service Centre will, at no extra charge, if your appliance is readily accessible without the need of special equipment and subject to the terms and conditions of this warranty, repair or replace any parts which it considers defective.

**WHAT IS NOT COVERED: By Our Warranty**

1. Products installed damaged or incomplete or not in compliance with the relevant electrical & plumbing regulations in their State.
2. Normal wear and tear e.g. cleaning, light globes, filters etc.
3. Failure resulting from power surges and electrical storms.
4. Insect or vermin infestation.
5. Unauthorised repairs or use of non- genuine Omega parts.
6. Any failure caused by the product not being used in accordance with the instruction and the installation manual provided with the product.
7. Misuse or abuse, including failure to properly maintain or service.
8. The clearing of blockages in pumps and hoses.
9. Damage which occurs during delivery or installation.
10. Claims to product surface coating due to liquid or solid spill-overs, accidental damage or damage caused from cleaning products not recommended by Omega.

**HOW TO CLAIM OUR WARRANTY**

You will need to contact Omega in Australia or New Zealand by using the contact details below.

**IN AUSTRALIA**

Omega is a division of Shriro Australia Pty Ltd  
ABN 28 002 386 129  
Head office: 104 Vanessa Street, Kingsgrove NSW 2208.  
Phone: (02) 9415 5000.  
Customer care: 1300 739 033.  
Web: [www.omegappliances.com.au](http://www.omegappliances.com.au)

**IN NEW ZEALAND**

Omega is a division of Monaco Corporation  
(Member of Shriro Australia Pty Ltd)  
Address: 231 Bush road, Albany, North Shore City,  
Auckland, New Zealand 0632.  
Phone: (09) 415 6000.  
Email: [service@shriro.com.au](mailto:service@shriro.com.au)

Note: Please complete the following details when you have unpacked the product:

Model No.....

Serial No.....

Date of Purchase.....

Retailer.....